

Lenovo

ThinkPad[®] X12 Detachable Gen 1

For Barcode Position Only

Printed in China

PN: XXXXXXX



* Lenovo USB-C to
VGA Adapter



* Lenovo USB-C to
HDMI Adapter



* Lenovo USB-C to
Ethernet Adapter



* Lenovo Precision Pen



* Lenovo Digital Pen



* Lenovo USB-C Port
Replicator



* ThinkPad X12 Detachable
Folio Keyboard

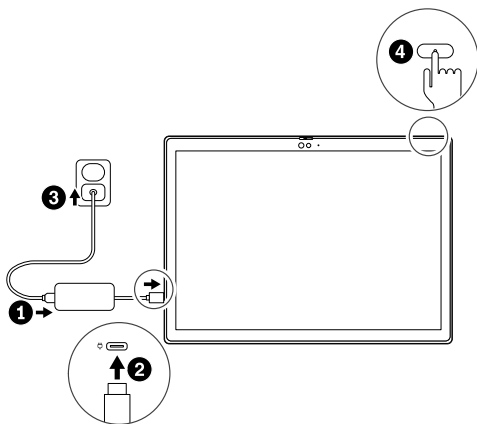

* For selected models

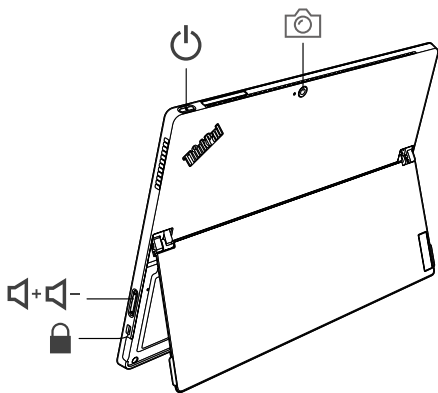
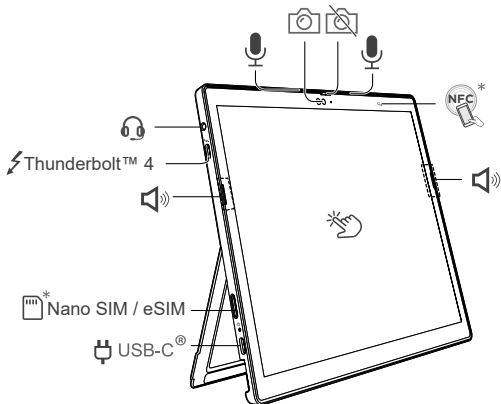

* For selected models

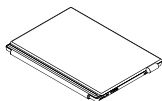
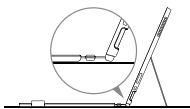

Lenovo Precision Pen

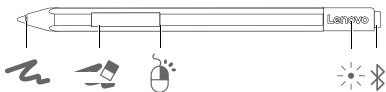

Lenovo Digital Pen

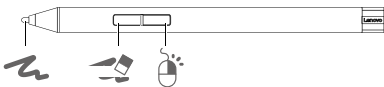

Commercial Vantage

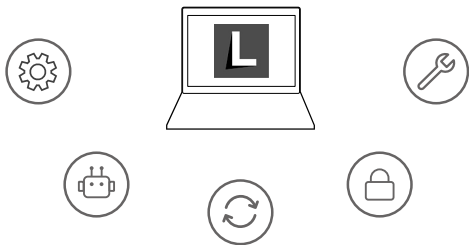

| Settings, Smart Assist, Updates, WiFi Security, Support & Warranty

Intelligent Cooling

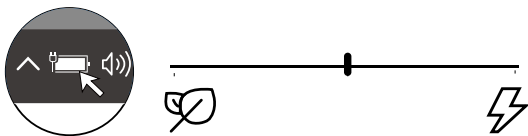

| Adjust Lenovo Intelligent Cooling through the Windows Power Slider to get the best mix of battery life, computer performance, and fan speed.



[English]

USB transfer rate

Read the statement on USB transfer rate in the *User Guide*. To access the *User Guide*, go to <https://pcsupport.lenovo.com>.

Specific absorption rate (SAR)

YOUR DEVICE MEETS INTERNATIONAL GUIDELINES FOR EXPOSURE TO RADIO WAVES.

Your device is a radio transmitter and receiver. It is designed not to exceed the limits for exposure to radio waves (radio frequency electromagnetic fields) recommended by international guidelines. The guidelines were developed by an independent scientific organization (ICNIRP) and include a substantial safety margin designed to assure the safety of all persons, regardless of age and health.

The radio wave exposure guidelines use a unit of measurement known as the Specific Absorption Rate, or SAR. Refer to the following for 10g SAR limit and maximum reported SAR values:

10g SAR limit: 2 W/kg (body-worn SAR); 4 W/kg (limb SAR)

Maximum SAR with 0 mm separation distance: 0.892 W/kg (body-worn SAR); 0.892 W/kg (limb SAR)

Where possible, your radio device should be used on a table, desk or tray, which also assists ventilation. To limit exposure from radio waves, use the device under good radio signal conditions and keep the antennas furthest from your body and that of other people. Refer to the *User Guide* of your product to view the locations of the antennas. Pregnant women should keep the antennas away from their stomach and adolescences away from their lower abdomen. Wearers of electronic implant devices (pacemakers, insulin pumps, neurostimulators, etc.) should maintain a distance greater than 15 centimeters between the radio device and the implant device. Obey all local

restrictions when using your device in public areas, such as hospitals, airplanes, or schools.

European Union — compliance with the Radio Equipment Directive

Hereby, Lenovo (Singapore) Pte. Ltd., declares that the radio equipment type ThinkPad X12 Detachable Gen 1 is in compliance with Directive 2014/53/EU. The full text of the system EU declaration of conformity is available at the following Internet address:

<https://www.lenovo.com/us/en/compliance/eu-doc>

This radio equipment operates with the following frequency bands and maximum radio-frequency power:

Technology	Frequency band [MHz]	Maximum transmit power
WLAN 802.11b/g/n/ax	2400 - 2483.5	< 20 dBm
WLAN 802.11a/n/ac/ax	5150 - 5725	< 23 dBm
WLAN 802.11a/n/ac/ax	5725 - 5875	< 13.98 dBm
Bluetooth BR/EDR/LE	2400 - 2483.5	< 20 dBm
WWAN UMTS	1/8	< 24.5 dBm
WWAN LTE	1/3/7/8/20/28	< 24 dBm
NFC	13.56	< -5.31 dBμA/m@10m

Usage of all the radio devices is limited to indoor in the band 5150 MHz to 5350 MHz (channels 36, 40, 44, 48, 52, 56, 60, 64).

First Edition (January 2021)

© Copyright Lenovo 2021.

LIMITED AND RESTRICTED RIGHTS NOTICE: If data or software is delivered pursuant to a General Services Administration "GSA" contract, use, reproduction, or disclosure is subject to restrictions set forth in Contract No. GS-35F-05925.

Reduce | Reuse | Recycle

