

User Guide

© Copyright 2013 Hewlett-Packard Development Company, L.P.

Bluetooth is a trademark owned by its proprietor and used by Hewlett-Packard Company under license. Microsoft, Windows, and Windows 7 are U.S. registered trademarks of Microsoft Corporation.

The information contained herein is subject to change without notice. The only warranties for HP products and services are set forth in the express warranty statements accompanying such products and services. Nothing herein should be construed as constituting an additional warranty. HP shall not be liable for technical or editorial errors or omissions contained herein.

First Edition: November 2013

Document Part Number: 744091-001

Product notice

This guide describes features that are common to most models. Some features may not be available on your computer.

This computer may require upgraded and/or separately purchased hardware and/or a DVD drive to install the Windows 7® software and take full advantage of Windows 7 functionality. See <http://windows.microsoft.com/en-us/windows7/get-know-windows-7> for details.

To obtain the latest information in this guide, contact support. For U.S. support, go to <http://www.hp.com/go/contactHP>. For worldwide support, go to http://welcome.hp.com/country/us/en/wwcontact_us.html.

Software terms

By installing, copying, downloading, or otherwise using any software product preinstalled on this computer, you agree to be bound by the terms of the HP End User License Agreement (EULA). If you do not accept these license terms, your sole remedy is to return the entire unused product (hardware and software) within 14 days for a refund subject to the refund policy of your place of purchase.

For any further information or to request a full refund of the computer, please contact your local point of sale (the seller).

Safety warning notice

 **WARNING!** To reduce the possibility of heat-related injuries or of overheating the computer, do not place the computer directly on your lap or obstruct the computer air vents. Use the computer only on a hard, flat surface. Do not allow another hard surface, such as an adjoining optional printer, or a soft surface, such as pillows or rugs or clothing, to block airflow. Also, do not allow the AC adapter to come into contact with the skin or a soft surface, such as pillows or rugs or clothing, during operation. The computer and the AC adapter comply with the user-accessible surface temperature limits defined by the International Standard for Safety of Information Technology Equipment (IEC 60950).

Table of contents

1 Starting right	1
Best practices	1
Fun things to do	1
More HP resources	2
2 Getting to know your computer	3
Finding your hardware and software information	3
Front	3
Right side	4
Left side	5
Display	7
Top	9
TouchPad	9
Lights	10
Button	12
Keys	13
Bottom	15
Labels	17
3 Connecting to a network	19
Connecting to a wireless network	19
Using the wireless controls	19
Using the wireless button	19
Using operating system controls	20
Using a WLAN	20
Using an Internet service provider	20
Setting up a WLAN	21
Configuring a wireless router	21
Protecting your WLAN	21
Connecting to a WLAN	22
Using Bluetooth wireless devices (select models only)	22
Connecting to a wired network	23
Connecting to a local area network (LAN)	23
4 Enjoying entertainment features	24
Multimedia features	24

Using the webcam	27
Using audio	27
Connecting speakers	28
Connecting headphones and microphones	28
Checking the sound	28
Using video	28
Connecting a VGA monitor or projector	29
Connecting an HDMI device	29
Configuring HDMI audio settings	30
Managing your audio and video files (select models only)	31
5 Using the keyboard and pointing devices	32
Using the keyboard	32
Using ALT GR key combinations	32
Using the action keys	32
Using the hot keys	33
Using the keypad	34
Using the integrated numeric keypad (select models only)	34
Using the TouchPad	34
Navigating	35
Selecting	35
Using TouchPad gestures	36
Scrolling	37
Pinching/zooming	37
6 Managing power	38
Using Sleep or Hibernation	38
Initiating and exiting Sleep	38
Initiating and exiting Hibernation	39
Setting password protection on wakeup	39
Using the power meter	39
Selecting a power plan	40
Running on battery power	40
Removing a user-replaceable battery	40
Finding battery information	42
Conserving battery power	42
Identifying low battery levels	43
Storing a user-replaceable battery	43
Disposing of a user-replaceable battery	43
Replacing a user-replaceable battery	43
Running on external power	43

Shutting down the computer	44
7 Managing and sharing information	45
Using a USB device	45
Connecting a USB device	45
Removing a USB device	46
Connecting a powered USB device	46
Inserting and removing a memory card	47
8 Maintaining your computer	48
Improving performance	48
Handling drives	48
Using Disk Defragmenter	48
Using Disk Cleanup	49
Adding or replacing memory modules	49
Updating programs and drivers	53
Cleaning your computer	53
Cleaning procedures	53
Cleaning the display (All-in-Ones or Notebooks)	53
Cleaning the sides or cover	54
Cleaning the TouchPad, keyboard, or mouse	54
Traveling with or shipping your computer	54
9 Securing your computer and information	56
Locating your security software	56
Using passwords	57
Setting Windows passwords	57
Setting Setup Utility (BIOS) passwords	58
Using Internet security software	58
Using antivirus software	58
Using firewall software	59
Installing software updates	59
Installing Windows security updates	59
Installing HP and third-party software updates	59
Securing your wireless network	59
Backing up your software applications and information	60
Using an optional security cable lock	60
10 Using Computer Setup (BIOS) and HP PC Hardware Diagnostics (UEFI)	61
Starting Setup Utility (BIOS)	61

Updating the BIOS	61
Determining the BIOS version	61
Downloading a BIOS update	62
Using System Diagnostics	62
Using HP PC Hardware Diagnostics (UEFI) (select models only)	63
Downloading HP PC Hardware Diagnostics (UEFI) to a USB device	63
11 Backing up, restoring, and recovering	64
Creating backups	64
Creating recovery media to recover the original system	64
What you need to know	64
Creating the recovery media	65
Creating system restore points	65
What you need to know	65
Creating a system restore point	65
Backing up system and personal information	65
Tips for a successful backup	66
What you need to know	66
Creating a backup using Windows Backup and Restore	66
Restore and recovery	67
Restoring to a previous system restore point	67
Restoring specific files	67
Restoring specific files using Windows Backup and Restore	67
Recovering the original system using HP Recovery Manager	67
What you need to know	67
Recovering using HP Recovery partition (select models only)	68
Recovering using the recovery media	68
Changing the computer boot order	69
12 Specifications	70
Input power	70
Operating environment	71
13 Troubleshooting and support	72
Troubleshooting	72
Wireless connection problems	72
Cannot connect to a WLAN	72
Cannot connect to a preferred network	72
Current network security codes are unavailable	73
WLAN connection is very weak	73

Cannot connect to the wireless router	74
Network status icon is not displayed	74
Audio problems	74
Power management problems	75
Resolving a low battery level	75
Resolving a low battery level when external power is available	75
Resolving a low battery level when no power source is available	75
Resolving a low battery level when the computer cannot exit	
Hibernation	75
Troubleshooting an AC adapter	75
Contacting support	76
14 Electrostatic Discharge	77
Index	78

1 Starting right

This computer is a powerful tool designed to enhance your work and entertainment. Read this chapter to learn about best practices after you set up your computer, fun things to do with your computer, and where to find additional HP resources.

Best practices

To protect your smart investment, after you set up and register the computer, we recommend the following steps:

- If you have not already done so, connect to a wired or wireless network. See details in [Connecting to a network on page 19](#).
- Become familiar with the computer hardware and software. Go to [Getting to know your computer on page 3](#) and [Enjoying entertainment features on page 24](#) for information.
- Update or purchase antivirus software. Learn more at [Using antivirus software on page 58](#).
- Back up your hard drive by creating recovery discs or a recovery flash drive. See [Backing up, restoring, and recovering on page 64](#).

Fun things to do

- You know you can watch a YouTube video on the computer. But did you know that you can also connect your computer to a TV and watch the video on TV? For more information, see [Connecting an HDMI device on page 29](#).
- You know you can listen to music on the computer. But did you know that you can also stream live radio to the computer and listen to music or talk radio from all over the world? See [Using audio on page 27](#).
- You know you can create a powerful presentation with Microsoft® applications. But did you know you can also connect to a projector to share your ideas with a group? See [Connecting a VGA monitor or projector on page 29](#).

More HP resources

You have already used *Setup Instructions* to turn on the computer and locate this guide. To locate resources that provide product details, how-to information, and more, use this table.

Resource	Contents
<i>Setup Instructions</i>	<ul style="list-style-type: none">• Overview of computer setup and features
Help and Support To access Help and Support, select Start > Help and Support . For more details, go to http://www.hp.com/support .	<ul style="list-style-type: none">• A broad range of how-to information and troubleshooting tips
<i>Safety & Comfort Guide</i> To access this guide, select Start > Help and Support > User Guides , or go to http://www.hp.com/ergo .	<ul style="list-style-type: none">• Proper workstation setup• Guidelines for posture and work habits that increase your comfort and decrease your risk of injury• Electrical and mechanical safety information
Worldwide support To get support in your language, go to http://www.hp.com/support .	<ul style="list-style-type: none">• Online chat with an HP technician• Email support• Worldwide support telephone numbers• HP service center locations
<i>Regulatory, Safety and Environmental Notices</i> To access this guide, select Start > Help and Support > User Guides .	<ul style="list-style-type: none">• Important regulatory notices, including proper battery disposal information
<i>Limited Warranty*</i> To access the warranty, select Start > Help and Support > User Guides or go to http://www.hp.com/go/orderdocuments .	<ul style="list-style-type: none">• Specific warranty information about this computer

*You can find the expressly provided HP Limited Warranty applicable to your product located with the user guides on your computer and/or on the CD/DVD provided in the box. In some countries/regions, HP may provide a printed HP Limited Warranty in the box. For countries/regions where the warranty is not provided in printed format, you may request a printed copy from <http://www.hp.com/go/orderdocuments> or write to:

- **North America:** Hewlett-Packard, MS POD, 11311 Chinden Blvd, Boise, ID 83714, USA
- **Europe, Middle East, Africa:** Hewlett-Packard, POD, Via G. Di Vittorio, 9, 20063, Cernusco s/Naviglio (MI), Italy
- **Asia Pacific:** Hewlett-Packard, POD, P.O. Box 200, Alexandra Post Office, Singapore 911507

When you request a printed copy of your warranty, please include your product number, warranty period (found on your service label), name, and postal address.

IMPORTANT: Do NOT return your HP product to the addresses above. For U.S. support, go to <http://www.hp.com/go/contactHP>. For worldwide support, go to http://welcome.hp.com/country/us/en/wwcontact_us.html.

2 Getting to know your computer

Finding your hardware and software information

- ▲ Select **Start > Computer**.

A list displays all of the storage devices installed in your computer, including optical drives, solid-state drives (SSD), or a secondary hard drive.

To find out what software is included on your computer, select **Start > All Programs**.



Front



Component	Description
 Memory card reader	Reads data from and writes data to memory cards such as Secure Digital (SD).

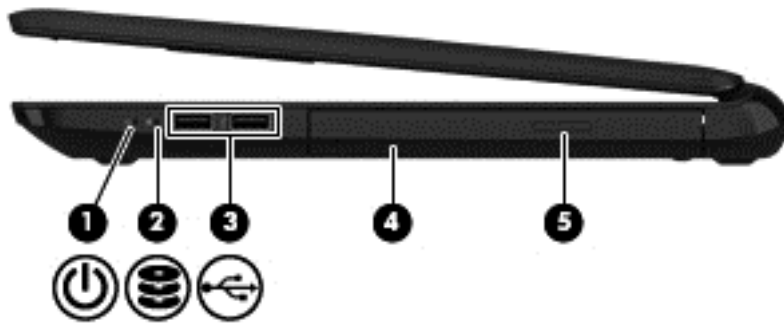





Right side

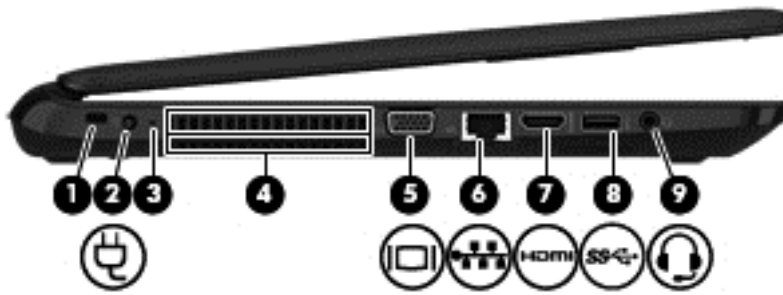



Component	Description
(1)  Power light	<ul style="list-style-type: none">• On: The computer is on.• Blinking: The computer is in the Sleep state, a power-saving state. The computer shuts off power to the display and other unneeded components.• Off: The computer is off or in Hibernation. Hibernation is a power-saving state that uses the least amount of power.
(2)  Hard drive light	Blinking white: The hard drive is being accessed.
(3)  USB 2.0 ports (2)	Connect an optional USB device, such as a keyboard, mouse, external drive, printer, scanner, or USB hub. NOTE: For details about different types of USB ports, see Using a USB device on page 45 .
(4) Optical drive (select models only)	Reads and writes (select models only) to an optical disc.
(5) Optical drive eject button (select models only)	Releases the disc tray.

Left side



Component	Description
(1) 	<p>Security cable slot</p> <p>Attaches an optional security cable to the computer.</p> <p>NOTE: The security cable is designed to act as a deterrent, but it may not prevent the computer from being mishandled or stolen.</p>
(2) 	<p>Power connector</p> <p>Connects an AC adapter.</p>
(3) 	<p>AC adapter light</p> <ul style="list-style-type: none"> White: The AC adapter is connected and the battery is charged. Amber: The AC adapter is connected and the battery is charging. Off: The computer is using battery power.
(4)	<p>Vent</p> <p>Enables airflow to cool internal components.</p> <p>NOTE: The computer fan starts up automatically to cool internal components and prevent overheating. It is normal for the internal fan to cycle on and off during routine operation.</p>
(5) 	<p>External monitor port</p> <p>Connects an external VGA monitor or projector.</p>
(6) 	<p>RJ-45 (network) jack/status lights</p> <p>Connects a network cable.</p> <ul style="list-style-type: none"> White: The network is connected. Amber: Activity is occurring on the network.
(7) 	<p>HDMI port</p> <p>Connects an optional video or audio device, such as a high-definition television, any compatible digital or audio component, or a high-speed HDMI device.</p>

Component	Description
(8)  USB 3.0 port	<p>Connects an optional USB device, such as a keyboard, mouse, external drive, printer, scanner, or USB hub.</p> <p>NOTE: For details about different types of USB ports, see Using a USB device on page 45.</p>
(9)  Audio-out (headphone)/Audio-in (microphone) jack	<p>Connects optional powered stereo speakers, headphones, earbuds, a headset, or a television audio cable. Also connects an optional headset microphone. This jack does not support optional microphone-only devices.</p> <p>WARNING! To reduce the risk of personal injury, adjust the volume before putting on headphones, earbuds, or a headset. For additional safety information, refer to the <i>Regulatory, Safety, and Environmental Notices</i>.</p> <p>NOTE: When a device is connected to the jack, the computer speakers are disabled.</p> <p>NOTE: Be sure that the device cable has a 4-conductor connector that supports both audio-out (headphone) and audio-in (microphone).</p>

Display

 **NOTE:** Refer to the image that most closely matches your computer.



Component	Description
(1) WLAN antennas (2)*	Send and receive wireless signals to communicate with wireless local area networks (WLANs).
(2) WWAN antennas (2)* (select models only)	Send and receive wireless signals to communicate with wireless wide area networks (WWAN).
(3) Webcam light	On: The webcam is in use.
(4) Webcam	Records video and captures still photographs. Some models provide access to video conferences and online chat by means of streaming video. To use the webcam, select Start > All Programs > Communication and Chat > CyberLink YouCam .
(5) Internal microphone	Records sound.
(6) Internal display switch	Turns off the display and initiates Sleep if the display is closed while the power is on. NOTE: The internal display switch is not visible from the outside of the computer.

*The antennas are not visible from the outside of the computer. For optimal transmission, keep the areas immediately around the antennas free from obstructions. For wireless regulatory notices, see the section of the *Regulatory, Safety, and Environmental Notices* that applies to your country or region. These notices are located in Help and Support.



Component	Description
(1) WLAN antennas (2)*	Send and receive wireless signals to communicate with wireless local area networks (WLANs).
(2) WWAN antennas (2)* (select models only)	Send and receive wireless signals to communicate with wireless wide area networks (WWAN).
(3) Webcam light	On: The webcam is in use.
(4) Webcam	Records video and captures still photographs. Some models provide access to video conferences and online chat by means of streaming video. To use the webcam, select Start > All Programs > Communication and Chat > CyberLink YouCam .
(5) Internal microphone	Records sound.
(6) Internal display switch	Turns off the display and initiates Sleep if the display is closed while the power is on. NOTE: The internal display switch is not visible from the outside of the computer.

*The antennas are not visible from the outside of the computer. For optimal transmission, keep the areas immediately around the antennas free from obstructions. For wireless regulatory notices, see the section of the *Regulatory, Safety, and Environmental Notices* that applies to your country or region. These notices are located in Help and Support.

Top

TouchPad

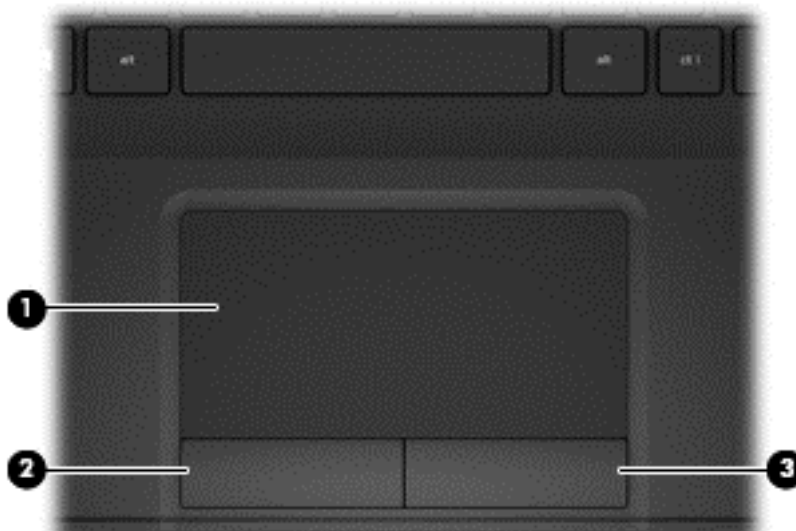



Component	Description
(1) TouchPad zone	Moves the on-screen pointer and selects or activates items on the screen.
(2) Left TouchPad button	Functions like the left button on an external mouse.
(3) Right TouchPad button	Functions like the right button on an external mouse.

Lights





NOTE: Refer to the image that most closely matches your computer.

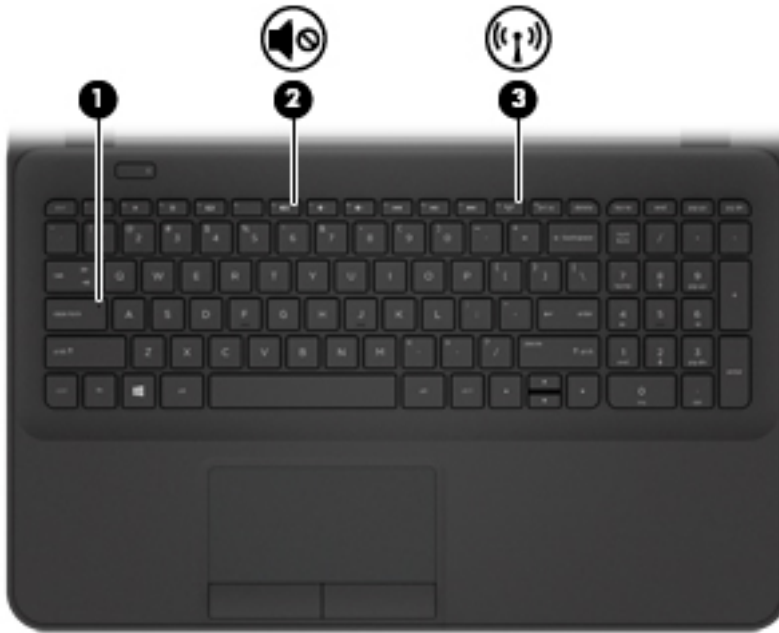

Component	Description
(1) Caps lock light	On: Caps lock is on, which switches the keys to all capital letters.
(2)  Mute light	<ul style="list-style-type: none">• Amber: Computer sound is off.• Off: Computer sound is on.
(3)  Wireless light	On: An integrated wireless device, such as a wireless local area network (WLAN) device and/or a Bluetooth® device, is on. NOTE: The wireless light is amber when all wireless devices are off.



Component	Description
(1) Caps lock light	On: Caps lock is on, which switches the keys to all capital letters.
(2)  Mute light	<ul style="list-style-type: none"> • Amber: Computer sound is off. • Off: Computer sound is on.
(3)  Wireless light	<p>On: An integrated wireless device, such as a wireless local area network (WLAN) device and/or a Bluetooth® device, is on.</p> <p>NOTE: The wireless light is amber when all wireless devices are off.</p>

Button



Component	Description
 Power button	<ul style="list-style-type: none">• When the computer is off, press the button to turn on the computer.• When the computer is on, press the button briefly to initiate Sleep.• When the computer is in the Sleep state, press the button briefly to exit Sleep.• When the computer is in Hibernation, press the button briefly to exit Hibernation. <p>CAUTION: Pressing and holding down the power button will result in the loss of unsaved information.</p> <p>If the computer has stopped responding and Windows® shutdown procedures are ineffective, press and hold the power button down for at least 5 seconds to turn off the computer.</p> <p>To learn more about your power settings, select Start > Control Panel > System and Security > Power Options, or see Managing power on page 38.</p>

Keys

 **NOTE:** Refer to the image that most closely matches your computer.

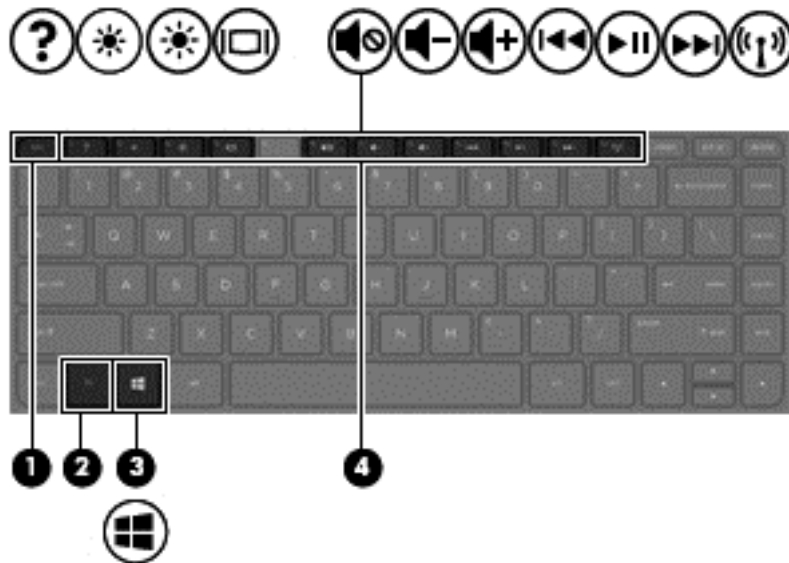

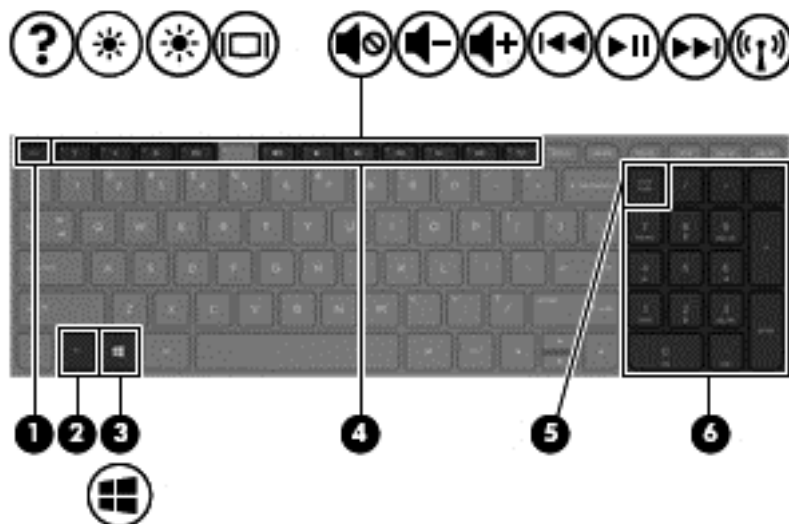

Component	Description
(1) esc key	Reveals system information when pressed in combination with the fn key.
(2) fn key	Reveals system information when pressed in combination with the esc key.
(3)  Windows key	Displays the Windows Start menu.
(4) Action keys	Execute frequently used system functions.

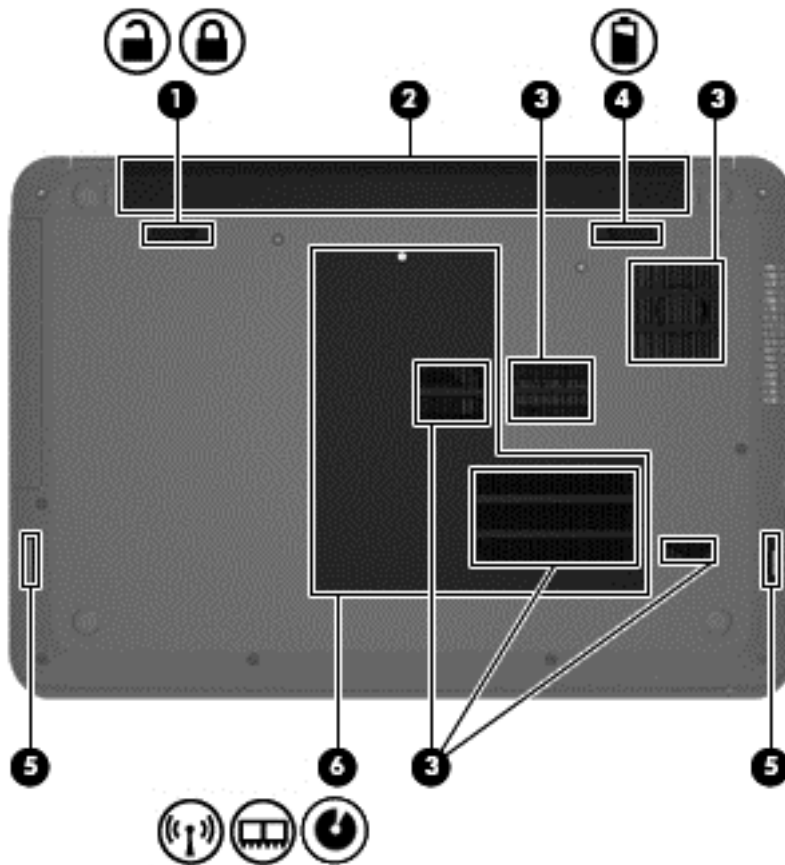

Component		Description
(1)	esc key	Reveals system information when pressed in combination with the fn key.
(2)	fn key	Reveals system information when pressed in combination with the esc key.
(3)	 Windows key	Displays the Windows Start menu.
(4)	Action keys	Execute frequently used system functions.
(5)	num lk key	Alternates between the navigational and numeric functions on the integrated numeric keypad. NOTE: The keypad function that is active when the computer is turned off is reinstated when the computer is turned back on.
(6)	Integrated numeric keypad	When num lk has been enabled, it can be used like an external numeric keypad. To alternate between this numeric function and the navigational function (indicated by the directional arrows on the keys), press the num lk key.

Bottom

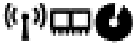

Component	Description
(1) 	Battery lock and unlock latch Locks and unlocks the battery into the battery bay.
(2)	Battery bay Holds the battery.
(3)	Vents (5) Enable airflow to cool internal components. NOTE: The computer fan starts up automatically to cool internal components and prevent overheating. It is normal for the internal fan to cycle on and off during routine operation.
(4) 	Battery release latch Releases the battery from the battery bay, after the battery lock latch is unlocked.

Component	Description
(5) Speaker openings (2)	Produce sound.
(6)  Service door	Provides access to the wireless LAN (WLAN) module slot, the memory module slot, and the optical drive (select models only).
	<p>CAUTION: To prevent an unresponsive system, replace the wireless module only with a wireless module authorized for use in the computer by the governmental agency that regulates wireless devices in your country or region. If you replace the module and then receive a warning message, remove the module to restore computer functionality, and then contact support through Help and Support.</p>
	Steps for removing the service door are included in Adding or replacing memory modules on page 49 .

Labels

The labels affixed to the computer provide information you may need when you troubleshoot system problems or travel internationally with the computer.

IMPORTANT: All labels described in this section will be located in one of 3 places depending on your computer model: Affixed to the bottom of the computer, located in the battery bay, or under the service door.

For help finding these locations, refer to [Getting to know your computer on page 3](#).

- Service label—Provides important information to identify your computer. When contacting support, you will probably be asked for the serial number, and possibly for the product number or the model number. Locate these numbers before you contact support.

NOTE: Your service labels will resemble one of the examples shown below. Refer to the illustration that most closely matches the service label on your computer.

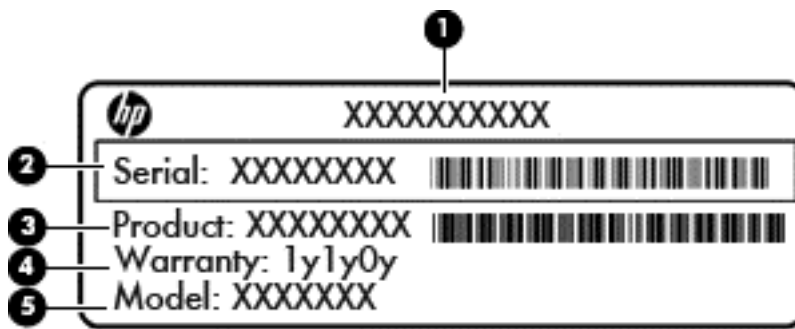

Component

- (1) Product name
- (2) Serial number
- (3) Product number
- (4) Warranty period
- (5) Model number (select models only)



Component

- (1) Serial number
- (2) Product number
- (3) Warranty period

Component

(4) Model number (select models only)

(5) Revision number

- Microsoft Certificate of Authenticity—Contains the Windows Product Key. You may need the Product Key to update or troubleshoot the operating system.
- Regulatory label(s)—Provide(s) regulatory information about the computer.
- Wireless certification label(s)—Provide(s) information about optional wireless devices and the approval markings for the countries or regions in which the devices have been approved for use.

3 Connecting to a network

Your computer can travel with you wherever you go. But even at home, you can explore the globe and access information from millions of websites using your computer and a wired or wireless network connection. This chapter will help you get connected to that world.

Connecting to a wireless network

Wireless technology transfers data across radio waves instead of wires. Your computer may be equipped with one or more of the following wireless devices:

- Wireless local area network (WLAN) device—Connects the computer to wireless local area networks (commonly referred to as Wi-Fi networks, wireless LANs, or WLANs) in corporate offices, your home, and public places such as airports, restaurants, coffee shops, hotels, and universities. In a WLAN, the mobile wireless device in your computer communicates with a wireless router or a wireless access point.
- Bluetooth device (select models only)—Creates a personal area network (PAN) to connect to other Bluetooth-enabled devices such as computers, phones, printers, headsets, speakers, and cameras. In a PAN, each device communicates directly with other devices, and devices must be relatively close together—typically within 10 meters (approximately 33 feet) of each other.

For more information about wireless technology, see the information and website links provided in Help and Support.

Using the wireless controls

You can control the wireless devices in your computer using these features:

- Wireless button, wireless switch, or wireless key (referred to in this chapter as the wireless button)
- Operating system controls

Using the wireless button

The computer has a wireless button, one or more wireless devices, and one wireless light, depending on the model. All of the wireless devices on your computer are enabled at the factory, so the wireless light is on (white) when you turn on the computer.

The wireless light indicates the overall power state of your wireless devices, not the status of individual devices. If the wireless light is white, at least one wireless device is on. If the wireless light is off, all wireless devices are off.

 **NOTE:** On some models, the wireless light is amber when all wireless devices are off.

Because the wireless devices are enabled at the factory, you can use the wireless button to turn on or turn off the wireless devices simultaneously.

Using operating system controls

The Network and Sharing Center allows you to set up a connection or network, connect to a network, manage wireless networks, and diagnose and repair network problems.

To use operating system controls, select **Start > Control Panel > Network and Internet > Network and Sharing Center**.

For more information, select **Start > Help and Support**.

Using a WLAN

With a WLAN device, you can access a wireless local area network (WLAN), which is composed of other computers and accessories that are linked by a wireless router or a wireless access point.



NOTE: The terms *wireless router* and *wireless access point* are often used interchangeably.

- A large-scale WLAN, such as a corporate or public WLAN, typically uses wireless access points that can accommodate a large number of computers and accessories and can separate critical network functions.
- A home or small office WLAN typically uses a wireless router, which allows several wireless and wired computers to share an Internet connection, a printer, and files without requiring additional pieces of hardware or software.

To use the WLAN device in your computer, you must connect to a WLAN infrastructure (provided through a service provider or a public or corporate network).

Using an Internet service provider

When you are setting up Internet access in your home, you must establish an account with an Internet service provider (ISP). To purchase Internet service and a modem, contact a local ISP. The ISP will help set up the modem, install a network cable to connect your wireless router to the modem, and test the Internet service.



NOTE: Your ISP will give you a user ID and a password to use for Internet access. Record this information and store it in a safe place.

Setting up a WLAN

To set up a WLAN and connect to the Internet, you need the following equipment:

- A broadband modem (either DSL or cable) **(1)** and high-speed Internet service purchased from an Internet service provider
- A wireless router **(2)** (purchased separately)
- A wireless computer **(3)**

 **NOTE:** Some modems have a built-in wireless router. Check with your ISP to determine what type of modem you have.

The illustration below shows an example of a wireless network installation that is connected to the Internet.

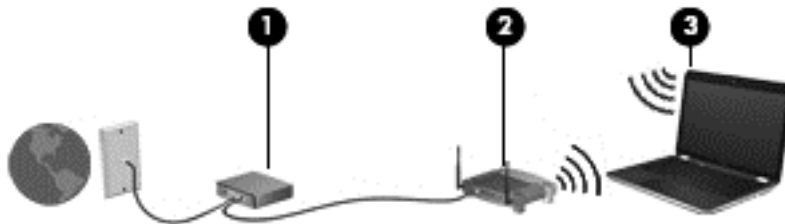

As your network grows, additional wireless and wired computers can be connected to the network to access the Internet.

For help in setting up your WLAN, see the information provided by your router manufacturer or your ISP.

Configuring a wireless router

For help in setting up a wireless router, see the information provided by your router manufacturer or your ISP.

 **NOTE:** It is recommended that you initially connect your new wireless computer to the router by using the network cable provided with the router. When the computer successfully connects to the Internet, disconnect the cable, and access the Internet through your wireless network.

Protecting your WLAN

When you set up a WLAN or access an existing WLAN, always enable security features to protect your network from unauthorized access. WLANs in public areas (hotspots) like coffee shops and airports may not provide any security. If you are concerned about the security of your computer when connected to a hotspot, limit your network activities to email that is not confidential and basic Internet surfing.

Wireless radio signals travel outside the network, so other WLAN devices can pick up unprotected signals. Take the following precautions to protect your WLAN:

- Use a firewall.
A firewall checks both information and requests that are sent to your network, and discards any suspicious items. Firewalls are available in both software and hardware. Some networks use a combination of both types.
- Use wireless encryption.
Wireless encryption uses security settings to encrypt and decrypt data that is transmitted over the network. For more information, see Help and Support.

Connecting to a WLAN

To connect to the WLAN, follow these steps:

1. Be sure that the WLAN device is on. If the device is on, the wireless light is white. If the wireless light is off, press the wireless button.

 **NOTE:** The wireless light is amber when all wireless devices are off.

2. Click the network status icon in the notification area, at the far right of the taskbar.
3. Select your WLAN from the list.
4. Click **Connect**.

If the WLAN is a security-enabled WLAN, you are prompted to enter a security code. Type the code, and then click **OK** to complete the connection.

 **NOTE:** If no WLANs are listed, you may be out of range of a wireless router or access point.

 **NOTE:** If you do not see the WLAN you want to connect to, click **Open Network and Sharing Center**, and then click **Set up a new connection or network**. A list of options is displayed, allowing you to manually search for and connect to a network or to create a new network connection.

After the connection is made, place the mouse pointer over the network status icon in the notification area, at the far right of the taskbar, to verify the name and status of the connection.

 **NOTE:** The functional range (how far your wireless signals travel) depends on WLAN implementation, router manufacturer, and interference from other electronic devices or structural barriers such as walls and floors.

Using Bluetooth wireless devices (select models only)

A Bluetooth device provides short-range wireless communications that replace the physical cable connections that traditionally link electronic devices such as the following:

- Computers (desktop, notebook, PDA)
- Phones (cellular, cordless, smart phone)
- Imaging devices (printer, camera)
- Audio devices (headset, speakers)
- Mouse

Bluetooth devices provide peer-to-peer capability that allows you to set up a personal area network (PAN) of Bluetooth devices. For information about configuring and using Bluetooth devices, see the Bluetooth software Help.

Connecting to a wired network

Connecting to a local area network (LAN)

Use a LAN connection if you want to connect the computer directly to a router in your home (instead of working wirelessly), or if you want to connect to an existing network at your office.

Connecting to a LAN requires an 8-pin, RJ-45 network cable.

To connect the network cable, follow these steps:

1. Plug the network cable into the network jack (1) on the computer.
2. Plug the other end of the network cable into a network wall jack (2) or router.

 **NOTE:** If the network cable contains noise suppression circuitry (3), which prevents interference from TV and radio reception, orient the circuitry end of the cable toward the computer.

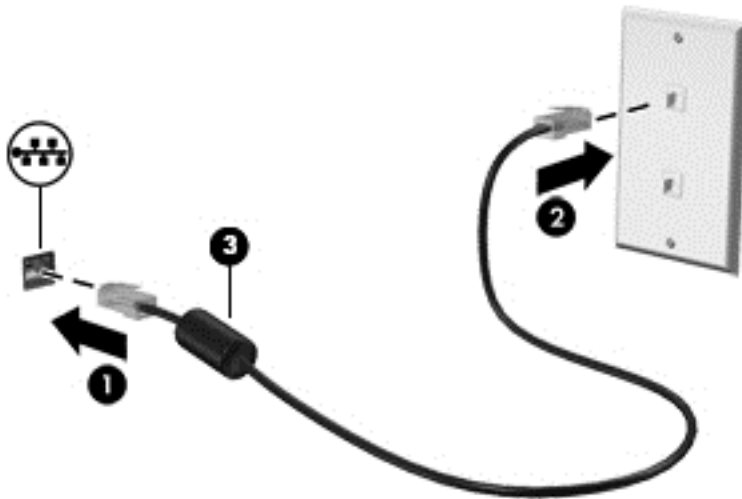

4 Enjoying entertainment features

Use your HP computer as an entertainment hub to socialize via the webcam, enjoy and manage your music, and download and watch movies. Or, to make your computer an even more powerful entertainment center, connect external devices like speakers, headphones, monitor, projector, TV, and high-definition devices.



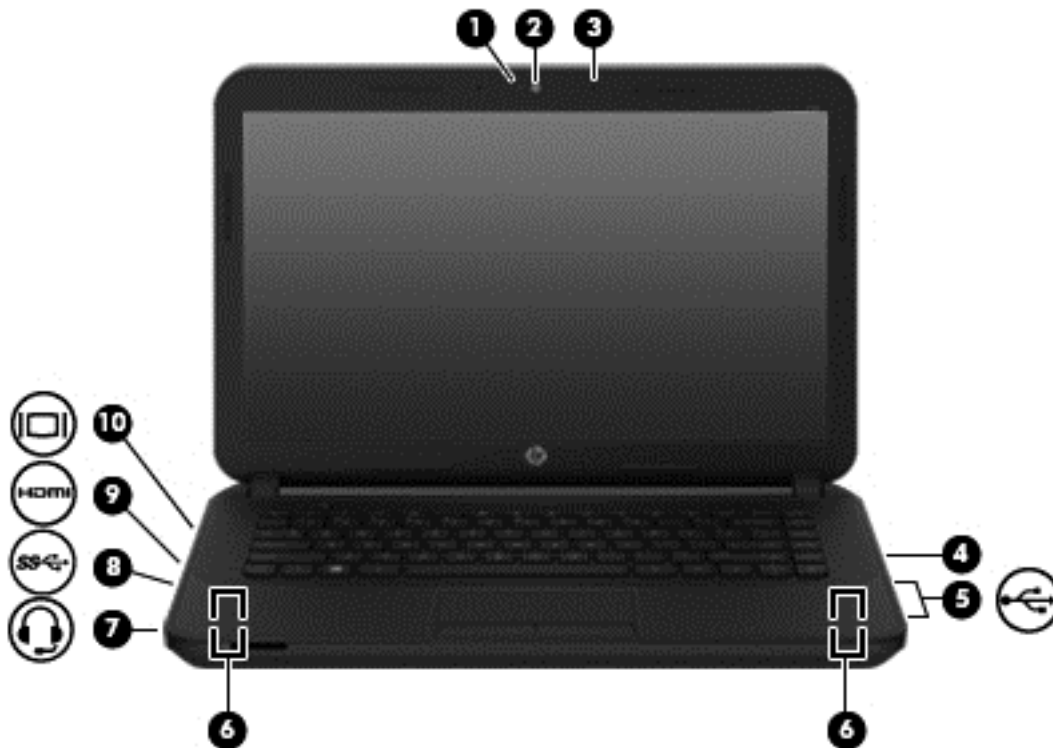

Multimedia features

Here are some of the entertainment features on your computer.

 **NOTE:** Refer to the image that most closely matches your computer.







Component	Description
(1)	Webcam light On: The webcam is in use.
(2)	Webcam Records video and captures still photographs. Some models allow you to video conference and chat online using streaming video. To use the webcam, select Start > All Programs > Communication and Chat > CyberLink YouCam .
(3)	Internal microphone Records sound.

Component	Description
(4) Optical drive (select models only)	<p>Depending on your computer model, reads an optical disc or reads and writes to an optical disc.</p> <p>NOTE: For disc compatibility information, go to the Help and Support web page (see More HP resources on page 2).</p>
(5)  USB 2.0 ports (2)	<p>Connect optional USB devices.</p> <p>NOTE: For details about different types of USB ports, see Using a USB device on page 45.</p>
(6) Speakers (2)	Produce sound.
(7)  Audio-out (headphone) /Audio-in (microphone) jack	<p>Connects optional powered stereo speakers, headphones, earbuds, a headset, or a television audio cable. Also connects an optional headset microphone. This jack does not support optional microphone-only devices.</p> <p>WARNING! To reduce the risk of personal injury, adjust the volume before putting on headphones, earbuds, or a headset. For additional safety information, refer to the <i>Regulatory, Safety, and Environmental Notices</i>.</p> <p>NOTE: When a device is connected to the jack, the computer speakers are disabled.</p> <p>NOTE: Be sure that the device cable has a 4-conductor connector that supports both audio-out (headphone) and audio-in (microphone).</p>
(8)  USB 3.0 port	<p>Connects an optional USB device, such as a keyboard, mouse, external drive, printer, scanner, or USB hub.</p> <p>NOTE: For details about different types of USB ports, see Using a USB device on page 45.</p>
(9)  HDMI port	<p>Connects an optional video or audio device, such as a high-definition television, any compatible digital or audio component, or a high-speed HDMI device.</p>
(10)  External monitor port	Connects an external VGA monitor or projector.



Component	Description
(1)	Webcam light On: The webcam is in use.
(2)	Webcam Records video and captures still photographs. Some models allow you to video conference and chat online using streaming video. To use the webcam, select Start > All Programs > Communication and Chat > CyberLink YouCam .
(3)	Internal microphone Records sound.
(4)	Optical drive (select models only) Depending on your computer model, reads an optical disc or reads and writes to an optical disc. NOTE: For disc compatibility information, go to the Help and Support web page (see More HP resources on page 2).
(5)	 USB 2.0 ports (2) Connect optional USB devices. NOTE: For details about different types of USB ports, see Using a USB device on page 45 .
(6)	Speakers (2) Produce sound.

Component	Description
(7)  Audio-out (headphone) /Audio-in (microphone) jack	<p>Connects optional powered stereo speakers, headphones, earbuds, a headset, or a television audio cable. Also connects an optional headset microphone. This jack does not support optional microphone-only devices.</p> <p>WARNING! To reduce the risk of personal injury, adjust the volume before putting on headphones, earbuds, or a headset. For additional safety information, refer to the <i>Regulatory, Safety, and Environmental Notices</i>.</p> <p>NOTE: When a device is connected to the jack, the computer speakers are disabled.</p> <p>NOTE: Be sure that the device cable has a 4-conductor connector that supports both audio-out (headphone) and audio-in (microphone).</p>
(8)  USB 3.0 port	<p>Connects an optional USB device, such as a keyboard, mouse, external drive, printer, scanner, or USB hub.</p> <p>NOTE: For details about different types of USB ports, see Using a USB device on page 45.</p>
(9)  HDMI port	<p>Connects an optional video or audio device, such as a high-definition television, any compatible digital or audio component, or a high-speed HDMI device.</p>
(10)  External monitor port	<p>Connects an external VGA monitor or projector.</p>

Using the webcam

Your computer has an integrated webcam, a powerful social networking tool that allows you to communicate up close with friends and colleagues next door or on the other side of the world. With the webcam, you can stream video with your instant messaging software, capture and share video, and take still photos.

To start the webcam, select **Start > All Programs > Communication and Chat > CyberLink YouCam**.

For details about using the webcam, select **Start > Help and Support**.

Using audio

On your HP computer, you can play music CDs (external optical drive purchased separately), download and listen to music, stream audio content from the web (including radio), record audio, or mix audio and video to create multimedia. To enhance your listening enjoyment, attach external audio devices such as speakers or headphones.

Connecting speakers

You can attach wired speakers to your computer by connecting them to a USB port or to the audio-out (headphone)/audio-in (microphone) jack on your computer or on a docking station.

To connect *wireless* speakers to your computer, follow the device manufacturer's instructions. To connect high-definition speakers to the computer, see [Configuring HDMI audio settings on page 30](#). Before connecting speakers, lower the volume setting.

Connecting headphones and microphones

You can connect wired headphones or headsets to the audio-out (headphone)/audio-in (microphone) jack on your computer. Many headsets with integrated microphones are commercially available. For best results when recording, speak directly into the microphone and record sound in a setting free of background noise.

 **WARNING!** To reduce the risk of personal injury, lower the volume before putting on headphones, earbuds, or a headset. For additional safety information, see the *Regulatory, Safety and Environmental Notices*.

Checking the sound

To check the audio functions on your computer, follow these steps:

1. Select **Start > Control Panel > Hardware and Sound > Sound**.
2. When the Sound window opens, click the **Sounds** tab. Under **Program Events**, select any sound event, such as a beep or alarm, and click the **Test** button.

You should hear sound through the speakers or through connected headphones.

To check the recording functions on your computer, follow these steps:

1. Select **Start > All Programs > Accessories > Sound Recorder**.
2. Click **Start Recording** and speak into the microphone. Save the file to your desktop.
3. Open a multimedia program and play the recording.

To confirm or change the audio settings on your computer, select **Start > Control Panel > Hardware and Sound > Sound**.

Using video

Your computer is a powerful video device that enables you to watch streaming video from your favorite websites and download video and movies to watch on your computer when you are not connected to a network.

To enhance your viewing enjoyment, use one of the video ports on the computer to connect an external monitor, projector, or TV. Most computers have a video graphics array (VGA) port, which connects an analog video device. Some computers also have a high-definition multimedia interface (HDMI) port, which allows you to connect a high-definition monitor or TV.

 **IMPORTANT:** Be sure that the external device is connected to the correct port on the computer, using the correct cable. Check the device manufacturer's instructions.

Connecting a VGA monitor or projector

To see the computer screen image on an external VGA monitor or projected for a presentation, connect a monitor or projector to the computer's VGA port.

To connect a monitor or projector:

1. Connect the VGA cable from the monitor or projector to the VGA port on the computer as shown.

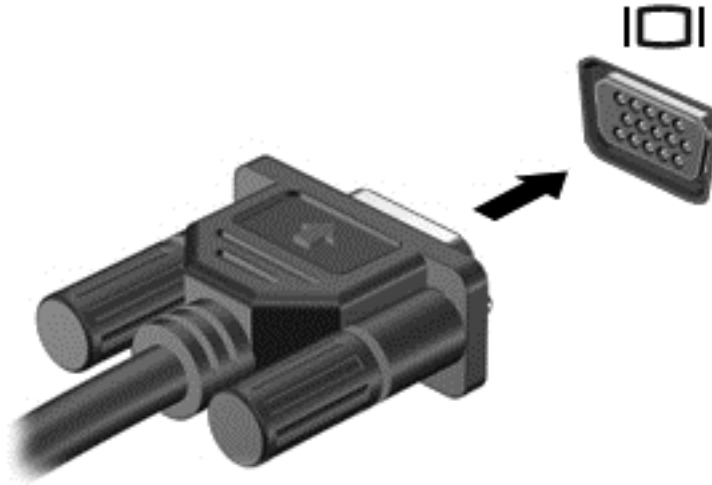

2. Press **f4** to alternate the screen image between 4 display states:
 - **PC Screen only:** View the screen image on the computer only.
 - **Duplicate:** View the screen image simultaneously on *both* the computer and the external device.
 - **Extend:** View the screen image extended across *both* the computer and the external device.
 - **Second screen only:** View the screen image on the external device only.

Each time you press **f4**, the display state changes.

Connecting an HDMI device

To see the computer screen image on a high-definition TV or monitor, connect the high-definition device according to the following instructions.

To connect an HDMI device to your computer, you need an HDMI cable, sold separately.

To connect a high-definition TV or monitor to your computer:

1. Connect one end of the HDMI cable to the HDMI port on the computer.

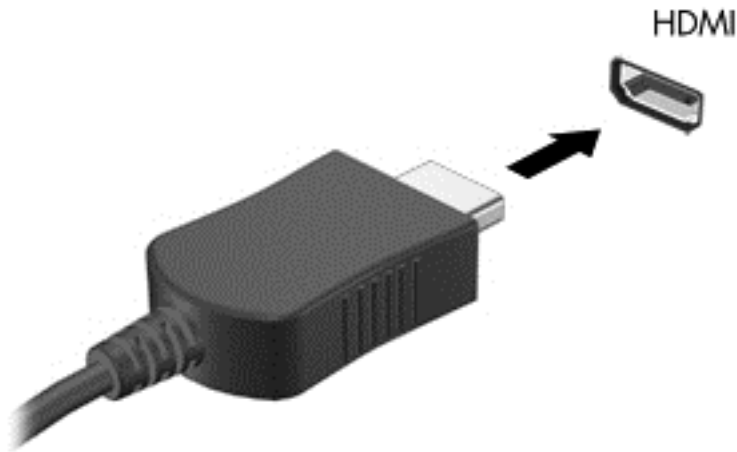

2. Connect the other end of the cable to the high-definition TV or monitor.
3. Press **f4** to alternate the computer screen image between 4 display states:
 - **PC screen only:** View the screen image on the computer only.
 - **Duplicate:** View the screen image simultaneously on *both* the computer and the external device.
 - **Extend:** View the screen image extended across *both* the computer and the external device.
 - **Second screen only:** View the screen image on the external device only.

Each time you press **f4**, the display state changes.

Configuring HDMI audio settings

HDMI is the only video interface that supports high-definition video *and* audio. After you connect an HDMI TV to the computer, you can then turn on HDMI audio by following these steps:

1. Right-click the **Speaker** icon in the notification area, at the far right of the taskbar, and then click **Playback devices**.
2. On the Playback tab, click **Digital Output Device (HDMI)**.
3. Click **Set Default**, and then click **OK**.

To return the audio stream to the computer speakers, follow these steps:

1. Right-click the **Speakers** icon in the notification area, at the far right of the taskbar, and then click **Playback devices**.
2. On the Playback tab, click **Speakers**.
3. Click **Set Default**, and then click **OK**.

Managing your audio and video files (select models only)

CyberLink PowerDVD helps you manage and edit your photo and video collections.

- ▲ To start CyberLink PowerDVD, select **Start > All Programs > Music, Photos and Videos**, and then click **CyberLink PowerDVD**.

For more information about using CyberLink PowerDVD, see the PowerDVD software Help.

5 Using the keyboard and pointing devices

Your computer allows easy on-screen navigation. In addition to the keyboard, a TouchPad allows you to perform on-screen functions. Select models also have special action keys or hot key functions to perform routine tasks simply.

In addition to the pointing devices, such as a TouchPad, included with your computer, you can use an external USB mouse (purchased separately) by connecting it to one of the USB ports on the computer.

To customize pointing device settings, button configuration, click speed, and pointer options, select **Start > Control Panel** and type `mouse` in the search box in the upper right corner of the screen. Click **Mouse**.

Using the keyboard

The keyboard allows you to type and the action keys and hot keys allow you to perform specific functions. For more details about the keyboard keys, see [Keys on page 13](#).



NOTE: Depending on the country or region, your keyboard may have different keys and keyboard functions than those discussed in this section.

Using ALT GR key combinations

Some countries have keyboards with an ALT GR key that is used for special key combinations. To type the rupee symbol on a keyboard that includes this key, use the `alt gr+4` key combination. Region-specific keyboards in India can use the `ctrl+shift+4` keys for the rupee symbol.

To learn about ALT GR key combinations, go to the Microsoft Office website, <http://www.office.microsoft.com>, and search for ALT GR.

Using the action keys

An action key performs an assigned function. The icon on each of the `f1` through `f4` keys and `f6` through `f12` keys illustrates the assigned function for that key.











To use an action key function, press and hold the key.

The action key feature is enabled at the factory. You can disable this feature in Setup Utility (BIOS). See [Using Computer Setup \(BIOS\) and HP PC Hardware Diagnostics \(UEFI\) on page 61](#) for instructions on opening Setup Utility (BIOS), and then follow the instructions at the bottom of the screen.

To activate the assigned function after disabling the action key feature, you must press the `fn` key in combination with the appropriate action key.



CAUTION: Use extreme care when making changes in Setup Utility. Errors can prevent the computer from operating properly.

Icon	Key	Description
	f1	Opens Help and Support, which provides tutorials, information about the Windows operating system and your computer, answers to questions, and updates to your computer. Help and Support also provides automated troubleshooting tools and access to support.
	f2	Decreases the screen brightness incrementally as long as you hold down the key.
	f3	Increases the screen brightness incrementally as long as you hold down the key.
	f4	Switches the screen image between display devices connected to the system. For example, if a monitor is connected to the computer, pressing this key alternates the screen image from the computer display to the monitor display to a simultaneous display on both the computer and the monitor.
	f6	Mutes or restores speaker sound.
	f7	Decreases speaker volume incrementally as long as you hold down the key.
	f8	Increases speaker volume incrementally as long as you hold down the key.
	f9	Plays the previous track of an audio CD or the previous section of a DVD or a BD.
	f10	Begins, pauses, or resumes playback of an audio CD, a DVD, or a BD.
	f11	Plays the next track of an audio CD or the next section of a DVD or a BD.
	f12	Turns the wireless feature on or off. NOTE: A wireless network must be set up before a wireless connection is possible.

Using the hot keys

A hot key is a combination of the **fn** key and the **esc** key, or one of the function keys.

To use a hot key:

- ▲ Briefly press the **fn** key, and then briefly press the second key of the hot key combination.

Function	Hot key	Description
Reveals system information.	fn+esc	Reveals information about system hardware components and the system BIOS version number.

Using the keypad

Using the integrated numeric keypad (select models only)

Some computer models include an integrated numeric keypad. The computer also supports an optional external numeric keypad or an optional external keyboard that includes a numeric keypad. For more details about the integrated numeric keypad, see [Keys on page 13](#).

Component	Description
num lock key	Controls the function of the integrated numeric keypad. Press the key to alternate between the standard numeric function of an external keypad (selected at the factory) and the navigational function (indicated by the directional arrows on the keys). NOTE: The keypad function that is active when the computer is turned off is reinstated when the computer is turned back on.
Integrated numeric keypad	Set at the factory to function like an external numeric keypad. To alternate between this numeric function and the navigational function (indicated by the directional arrows on the keys), press the num lock key.

Using the TouchPad

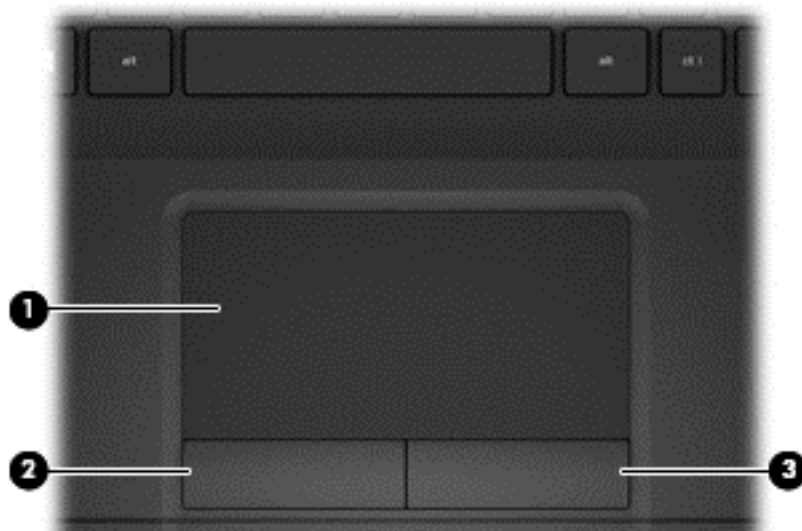

Component	Description
(1) TouchPad zone	Moves the on-screen pointer and selects or activates items on the screen.
(2) Left TouchPad button	Functions like the left button on an external mouse.
(3) Right TouchPad button	Functions like the right button on an external mouse.

To move the pointer, slide one finger across the TouchPad in the direction you want the pointer to go. Use the left and right TouchPad buttons as you would use the buttons on an external mouse.

Navigating

To move the on-screen pointer, slide one finger across the TouchPad in the direction you want the pointer to go.

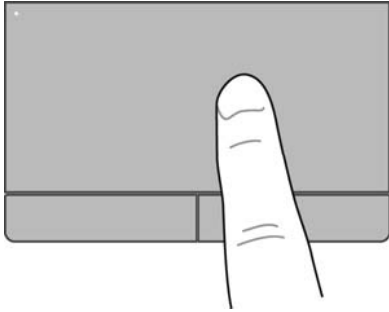

Selecting

Use the left and right TouchPad buttons as you would use the corresponding buttons on an external mouse.

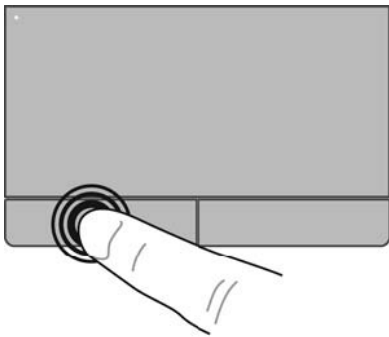

Using TouchPad gestures

The TouchPad supports a variety of gestures that let your fingers swipe, pinch, and rotate to manipulate items on the desktop. To use TouchPad gestures, place two fingers on the TouchPad at the same time.



NOTE: TouchPad gestures are not supported in all programs.

To view the demonstration of a gesture:

1. Select **Start > Control Panel > Hardware and Sound > Synaptics TouchPad**.
2. Click a gesture to activate the demonstration.

To turn the gestures off or on:

1. Select **Start > Control Panel > Hardware and Sound > Synaptics TouchPad**.
2. Select the check box next to the gesture that you want to turn off or on.
3. Click **Apply**, and then click **OK**.

Scrolling

Scrolling is useful for moving up, down, or sideways on a page or image. To scroll, place two fingers slightly apart on the TouchPad, and then drag them across the TouchPad in an up, down, left, or right motion.

 **NOTE:** Scrolling speed is controlled by finger speed.

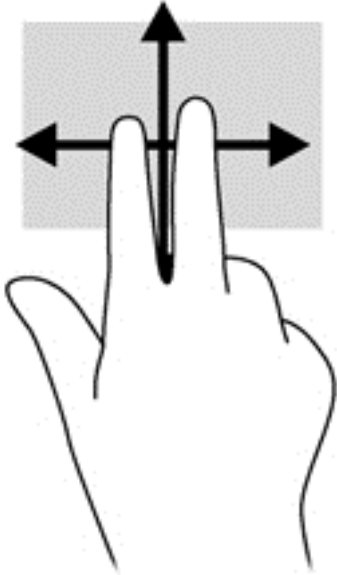

Pinching/zooming

Pinching allows you to zoom in or out on images or text.

- Zoom in by placing two fingers together on the TouchPad, and then moving them apart.
- Zoom out by placing two fingers apart on the TouchPad, and then moving them together.

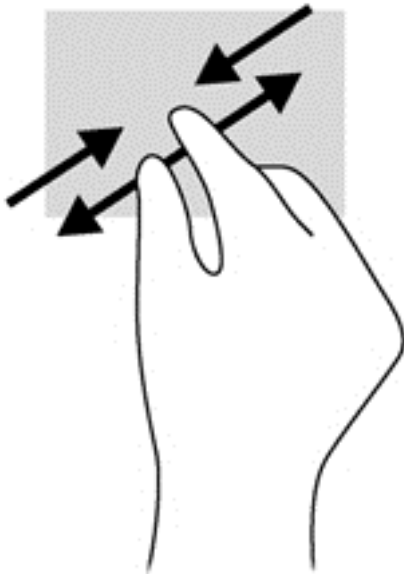

6 Managing power

Your computer can operate on either battery power or external power. When the computer is running on battery power only and an AC power source is not available to charge the battery, it is important to monitor and conserve the battery charge. Your computer supports an optimal power plan to manage how your computer uses and conserves power so that computer performance is balanced with power conservation.

Using Sleep or Hibernation

Microsoft Windows has two power-saving states, Sleep and Hibernation.

When Sleep is initiated, the screen clears, and your work is saved to memory, allowing you to resume your work faster than when you exit Hibernation. If the computer is in the Sleep state for an extended period or if the battery reaches a critical battery level while in the Sleep state, the computer initiates Hibernation.

In the Hibernation state, your work is saved to a hibernation file on the hard drive and the computer turns off.

 **CAUTION:** To reduce the risk of possible audio and video degradation, loss of audio or video playback functionality, or loss of information, do not initiate Sleep or Hibernation while reading from or writing to a disc or an external memory card.

 **NOTE:** You cannot initiate any type of networking connection or perform any computer functions while the computer is in the Sleep state or in Hibernation.

Initiating and exiting Sleep

The system is set at the factory to initiate Sleep after a specific period of inactivity, depending on whether the computer is running on battery power or on external power.

Power settings and timeouts can be changed using Power Options in Windows Control Panel.

With the computer on, you can initiate Sleep in any of the following ways:

- Briefly press the power button.
- Close the display.
- Select **Start**, click the arrow next to the Shut down button, and then click **Sleep**.

To exit Sleep:

- Briefly press the power button.
- If the display is closed, open the display.
- Press a key on the keyboard.
- Tap or swipe the TouchPad.

When the computer exits Sleep, the power lights turn on and the computer displays the screen as it was when you stopped working.



NOTE: If you have set the computer to require a password on wakeup, you must enter your Windows password before the computer redisplay your work.

Initiating and exiting Hibernation

The system is set at the factory to initiate Hibernation after a specific period of inactivity, depending on whether the computer is running on battery power or on external power, or when the battery reaches a critical battery level.

Power settings and timeouts can be changed in Windows Control Panel.

To initiate Hibernation, select **Start**, click the arrow next to the Shut down button, and then click **Hibernate**.

To exit Hibernation, briefly press the power button.

The power lights turn on and the computer returns to the screen where you stopped working.



NOTE: If you have set a password to be required on wakeup, you must enter your Windows password before the computer will return to the screen.

Setting password protection on wakeup

To set the computer to prompt for a password when exiting Sleep or Hibernation, follow these steps:

1. Select **Start > Control Panel > System and Security > Power Options**.
2. In the left pane, click **Require a password on wakeup**.
3. Click **Change Settings that are currently unavailable**.
4. Click **Require a password (recommended)**.



NOTE: If you need to create a user account password or change your current user account password, click **Create or change your user account password**, and then follow the on-screen instructions.

5. Click **Save changes**.

Using the power meter

The power meter allows you to quickly access power settings and view the remaining battery charge.

- To display the percentage of remaining battery charge and the current power plan, move the pointer over the Power Meter icon, at the far right of the taskbar.
- To access Power Options, or to change the power plan, click the Power Meter icon and select an item from the list.

Different power meter icons indicate whether the computer is running on battery or external power. The battery icon displays a message if the battery reaches a low or critical battery level.

Selecting a power plan

A power plan manages how the computer uses power and helps you conserve power and maximize performance.

The following power plans are available:

- **HP Recommended.** Automatically balances performance with energy conservation.
- **Power Saver.** Saves power by reducing system performance and screen brightness.
- **High Performance.** Favors performance, but may use more energy.

You can also create your own power plan and customize it to suit your needs.

Use HP Power Manager (select models only) or Windows Control Panel to select a power plan or to create your own plan.

To start HP Power Manager, select **Start > Control Panel > Hardware and Sound > HP Power Manager**.

To access the Power Options in the Control Panel, select **Start > Control Panel > System and Security > Power Options**, and then select a power plan from the list.

Running on battery power

When a charged battery is in the computer and the computer is not plugged into external power, the computer runs on battery power and the display brightness decreases to conserve battery life. The battery in the computer slowly discharges when the computer is off and unplugged from external power.

Computer battery life varies, depending on power management settings, programs running on the computer, display brightness, external devices connected to the computer, and other factors.

Removing a user-replaceable battery

WARNING! To reduce potential safety issues, use only the user-replaceable battery provided with the computer, a replacement battery provided by HP, or a compatible battery purchased from HP.

CAUTION: Removing a user-replaceable battery that is the sole power source for the computer can cause loss of information. To prevent loss of information, save your work or shut down the computer through Windows before removing the battery.

1. Slide the battery lock latch **(1)**, and then slide the battery release latch **(2)** to release the battery.

2. Remove the battery (3) from the computer.

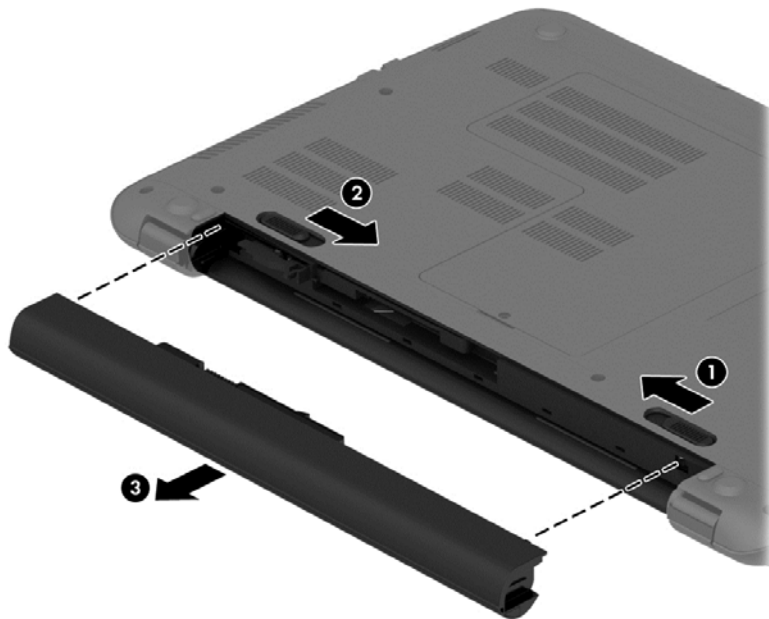

To insert the battery, follow these steps:

⚠ CAUTION: Do not slant the battery as you insert it.

1. Holding the battery in the middle, slide the battery (1) straight into the computer until the battery release latch locks into place.
2. Reset the battery lock latch (2) to the locked position.

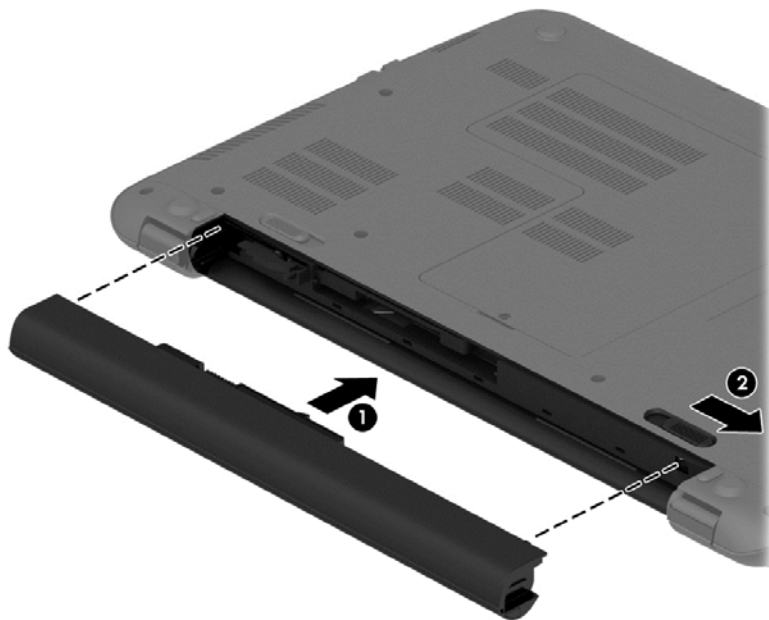

Finding battery information

Help and Support provides the following tools and information about the battery:

- Battery Check tool in Help and Support to test battery performance
- Information about calibration, power management, and proper care and storage to maximize battery life
- Information about battery types, specifications, life cycles, and capacity

To access battery information, select **Start > Help and Support > Learn > Power Plans: Frequently Asked Questions**.

Conserving battery power

Use the following tips for conserving battery power and maximizing battery life:

- Lower the brightness on the display.
- Select the **Power saver** setting in Power Options.
- Remove the battery from the computer when it is not being used or charged.
- Turn off wireless devices when you are not using them.
- Disconnect unused external devices that are not plugged into an external power source, such as an external hard drive connected to a USB port.
- Stop, disable, or remove any external memory cards that you are not using.
- Before you leave your computer, initiate Sleep or Hibernation, or shut down the computer.

Identifying low battery levels

When a battery that is the sole power source for the computer reaches a low or critical battery level, the power meter icon in the notification area displays a low or critical battery notification.

 **NOTE:** For additional information about the power meter, see [Using the power meter on page 39](#).

The computer takes the following actions for a critical battery level:

- If Hibernation is enabled and the computer is on or in the Sleep state, the computer initiates Hibernation.
- If Hibernation is disabled, and the computer is on or in the Sleep state, the computer remains briefly in the Sleep state, and then shuts down and loses any unsaved information.

Storing a user-replaceable battery

 **CAUTION:** To reduce the risk of damage to a battery, do not expose it to high temperatures for extended periods of time.

If your computer will be unused and unplugged from external power for more than 2 weeks, remove the battery and store it separately in a cool, dry place to prolong the battery charge.

A stored battery should be checked every 6 months. If the capacity is less than 50 percent, recharge the battery before returning it to storage.

Disposing of a user-replaceable battery

 **WARNING!** To reduce the risk of fire or burns, do not disassemble, crush, or puncture; do not short external contacts; do not dispose of in fire or water.

See the *Regulatory, Safety and Environmental Notices* for proper battery disposal. To access this guide, select **Start > Help and Support > User Guides**.

Replacing a user-replaceable battery

Battery Check in Help and Support notifies you to replace the battery when an internal cell is not charging properly or when the battery storage capacity has reached a weak condition. If the battery is possibly covered by an HP warranty, instructions include a warranty ID. A message refers you to the HP website for more information about ordering a replacement battery.

Running on external power

For information about connecting to AC power, see the *Setup Instructions* provided in the computer box.

The computer does not use battery power when the computer is connected to external power with an approved AC adapter or an optional docking/expansion device.

 **WARNING!** To reduce potential safety issues, use only the AC adapter provided with the computer, a replacement AC adapter provided by HP, or a compatible AC adapter purchased from HP.

Connect the computer to external power under any of the following conditions:

 **WARNING!** Do not charge the computer battery while you are onboard an aircraft.

- When charging or calibrating a battery
- When installing or modifying system software

- When writing information to a disc (select models only)
- When running Disk Defragmenter on computers with internal hard drives
- When performing a backup or recovery

When you connect the computer to external power:

- The battery begins to charge.
- The display brightness increases.
- The Power Meter icon in the notification area changes appearance.

When you disconnect external power, the following events occur:

- The computer switches to battery power.
- The display brightness automatically decreases to save battery life.
- The Power Meter icon in the notification area changes appearance.

Shutting down the computer

 **CAUTION:** Unsaved information is lost when the computer shuts down.

The Shut down command closes all open programs, including the operating system, and then turns off the display and computer.

Shut down the computer under any of the following conditions:

- When you need to replace the battery or access components inside the computer
- When you are connecting an external hardware device that does not connect to a USB or video port
- When the computer will be unused and disconnected from external power for an extended period

Although you can shut down the computer with the power button, the recommended procedure is to use the Windows Shut down command:

 **NOTE:** If the computer is in the Sleep state or in Hibernation, you must first exit Sleep or Hibernation before shutdown is possible.

1. Save your work and close all open programs.
2. Select **Start > Shut down**.

If the computer is unresponsive and you are unable to use the preceding shutdown procedures, try the following emergency procedures in the sequence provided:

- Press **ctrl+alt+delete**, and then click the **Shut down** icon on the display.
- Press and hold the power button for at least 5 seconds.
- Disconnect the computer from external power.
- Remove the battery.

7 Managing and sharing information

Drives are digital storage devices that help you store, manage, share, and access information. Your computer has an internal hard drive that stores your computer's software, operating system, as well as providing storage for all of your personal files.

For added capacity or functionality, connect an external drive (purchased separately), such as an optical drive or hard drive, or insert a memory card to import information directly from your phone or camera. A USB flash drive, connected to the Universal Serial Bus (USB) port on your computer, also allows quick data transfer. Some devices use the computer's power to run; others have their own power source. Some devices come with software that must be installed.

 **NOTE:** For information about connecting external wireless devices, see [Connecting to a network on page 19](#).

 **NOTE:** For more information about required software and drivers, or to learn which computer port to use, see the manufacturer's instructions.

Using a USB device

Most computers have more than one USB port, because this versatile interface allows you to connect numerous kinds of external devices—such as a USB keyboard, mouse, external drive, printer, scanner, or USB hub—to your computer.

Your computer has more than one type of USB port. See [Getting to know your computer on page 3](#) for the types of USB ports you have on this computer. Be sure to purchase devices that are compatible with your computer.

Type	Description
USB 2.0	Transfers data at 60 MB/s.
USB 3.0	Transfers data at 640 MB/s. USB 3.0 ports, also known as SuperSpeed ports, are also compatible with USB 1.0 and 2.0 devices.

Connecting a USB device

 **CAUTION:** To reduce the risk of damage to a USB connector, use minimal force to connect the device.

- ▲ Connect the USB cable for the device to the USB port.

 **NOTE:** The USB port on your computer may look slightly different from the illustration in this section.



A sound indicates that the device has been detected.

 **NOTE:** The first time you connect a USB device, a message in the notification area lets you know that the device is recognized by the computer.

Removing a USB device

 **CAUTION:** To reduce the risk of damage to a USB connector, do not pull on the cable to remove the USB device.

CAUTION: To reduce the risk of loss of information or an unresponsive system, use the following procedure to safely remove the USB device.

1. To remove a USB device, save your information and close all programs associated with the device.
2. Click the remove hardware icon in the notification area, at the far right of the taskbar, and then follow the on-screen instructions.
3. Remove the device.

Connecting a powered USB device

 **CAUTION:** To reduce the risk of damage to the equipment when connecting a powered device, be sure that the device is turned off and its AC power cord is unplugged.

1. Connect the device to the computer.
2. Plug the device power cord into a grounded AC outlet.
3. Turn on the device.

To disconnect an unpowered external device, stop the device, and then disconnect it from the computer. To disconnect a powered external device, turn off the device, disconnect it from the computer, and then unplug the AC power cord.

Inserting and removing a memory card

To insert a memory card:

CAUTION: To reduce the risk of damage to the memory card connectors, use minimal force to insert a memory card.

1. Hold the card label-side up, with the connectors facing the computer.
2. Insert the card into the memory card reader, and then press in on the card until it is firmly seated.

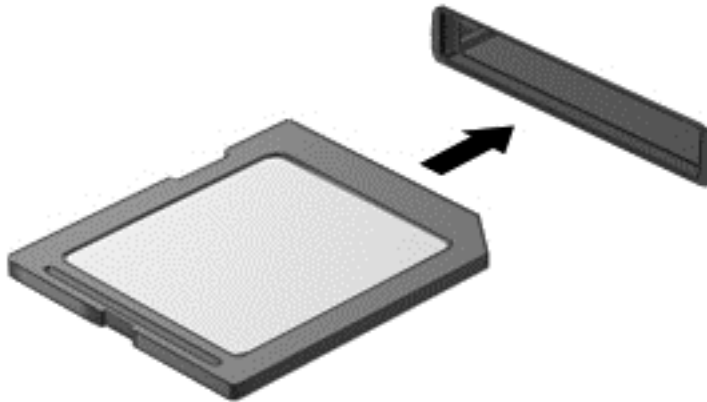

A sound indicates that the device has been detected, and a menu of options displays.

To remove a memory card:

CAUTION: To reduce the risk of loss of data or an unresponsive system, use the following procedure to safely remove the digital card.

1. Save your information and close all programs associated with the memory card.
2. Click the remove hardware icon in the notification area, at the far right of the taskbar. Then follow the on-screen instructions.
3. Press in on the card **(1)**, and then remove it from the slot **(2)**.

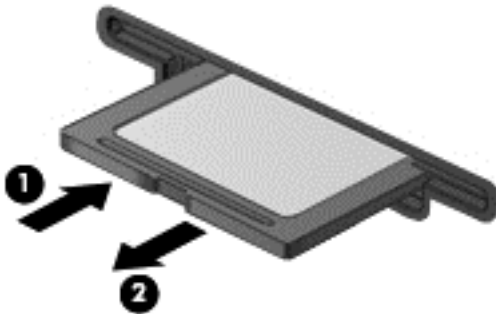

NOTE: If the card is not ejected, pull the card out of the slot.

8 Maintaining your computer

It is important to perform regular maintenance to keep your computer in optimal condition. This chapter provides information about improving the performance of your computer by running tools such as Disk Defragmenter and Disk Cleanup and by replacing a hard drive or adding memory. It also provides information about updating your programs and drivers, instructions for cleaning your computer, and tips for traveling with your computer.

Improving performance

Everyone wants a fast computer and by performing regular maintenance tasks, using tools such as Disk Defragmenter and Disk Cleanup, you can drastically improve the performance of your computer. Also, as your computer gets older, you might consider installing larger drives and adding more memory.

Handling drives

Observe these precautions when handling drives:

- When the battery is the only source of power, be sure that the battery is sufficiently charged before writing to media.
- Do not move an optical drive while it is writing to a disc. The write process is sensitive to vibration.
- Before you move a computer that is connected to an external hard drive, initiate Sleep and allow the screen to clear, or properly disconnect the external hard drive.

Using Disk Defragmenter

As you use your computer over time, the files on the hard drive become fragmented. A fragmented drive means data on your drive is not contiguous (sequential) and, because of this, the hard drive works harder to locate files, thus slowing down the computer. Disk Defragmenter consolidates (or physically reorganizes) the fragmented files and folders on the hard drive so that the system can run more efficiently.



NOTE: It is not necessary to run Disk Defragmenter on solid-state drives.

After you start Disk Defragmenter, it works without supervision. However, depending on the size of your hard drive and the number of fragmented files, Disk Defragmenter may take more than an hour to complete.

HP recommends defragmenting your hard drive at least once a month. You may set Disk Defragmenter to run on a monthly schedule, but you can defragment your computer manually at any time.

To run Disk Defragmenter:

1. Connect the computer to AC power.
2. Select **Start > All Programs > Accessories > System Tools > Disk Defragmenter**.
3. Follow the on-screen instructions.

For additional information, access the Disk Defragmenter software Help.

Using Disk Cleanup

Disk Cleanup searches the hard drive for unnecessary files that you can safely delete to free up disk space and help the computer run more efficiently.

To run Disk Cleanup:

1. Select **Start > All Programs > Accessories > System Tools > Disk Cleanup**.
2. Follow the on-screen instructions.

Adding or replacing memory modules

Adding memory can help improve your computer's performance. Your computer is like your physical work area. The hard drive is the filing cabinet where you store your work and the memory is the desk where you work. When your memory is not big enough to hold all your work easily, like a desk overflowing with work, your productivity slows down. A great solution to improve performance is to expand the amount of memory you have in your computer.

The computer will have either one or two memory module slots depending on the model. The memory module slots are located on the bottom of the computer under the service door. The memory capacity of the computer can be upgraded by replacing the existing memory modules.

 **NOTE:** Before adding or replacing a memory module, make sure the computer has the most recent BIOS version, and update the BIOS is needed. See [Updating the BIOS on page 61](#).

 **CAUTION:** Failure to update the computer to the latest BIOS prior to installing or replacing a memory module may result in various system problems.

 **WARNING!** To reduce the risk of electric shock and damage to the equipment, unplug the power cord and remove all batteries before installing a memory module.

 **CAUTION:** Electrostatic discharge (ESD) can damage electronic components. Before beginning any procedure, ensure that you are discharged of static electricity by touching a grounded metal object.

To add or replace a memory module:

 **CAUTION:** To prevent information loss or an unresponsive system:

Shut down the computer before adding or replacing memory modules. Do not remove a memory module while the computer is on, in the Sleep state, or in Hibernation.

If you are not sure whether the computer is off or in Hibernation, turn the computer on by pressing the power button. Then shut down the computer through the operating system.

1. Save your work and shut down the computer.
2. Disconnect all external devices connected to the computer.
3. Unplug the power cord from the AC outlet.
4. Turn the computer upside down on a flat surface.
5. Remove the battery from the computer. See [Removing a user-replaceable battery on page 40](#).

6. Remove the service door from the computer:
 - a. With the battery bay toward you, remove the service door screw (1).
 - b. Slide the service door toward the front of the computer (2), and then lift up (3) to remove the service door .

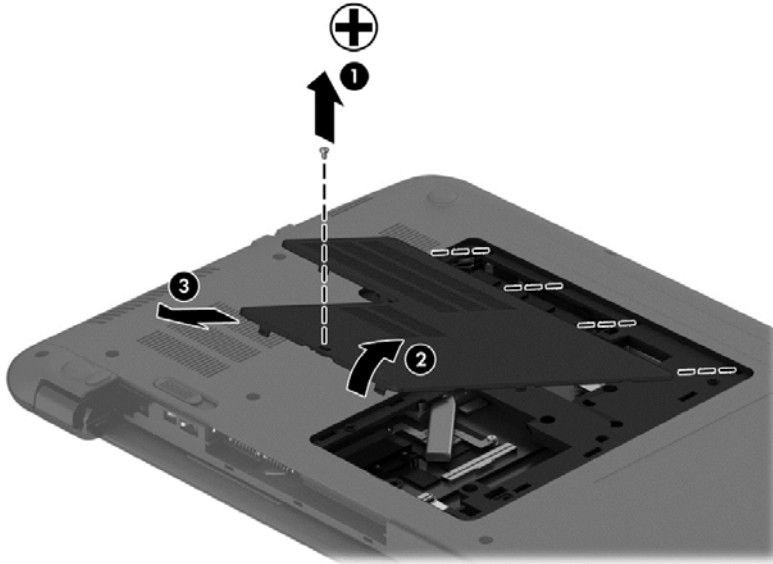

7. If you are replacing a memory module, remove the existing memory module:
 - a. Pull away the retention clips (1) on each side of the memory module.
The memory module tilts up.

- b. Grasp the edge of the memory module **(2)**, and then gently pull the module out of the memory module slot.

CAUTION: To prevent damage to the memory module, hold the memory module by the edges only. Do not touch the components on the memory module.

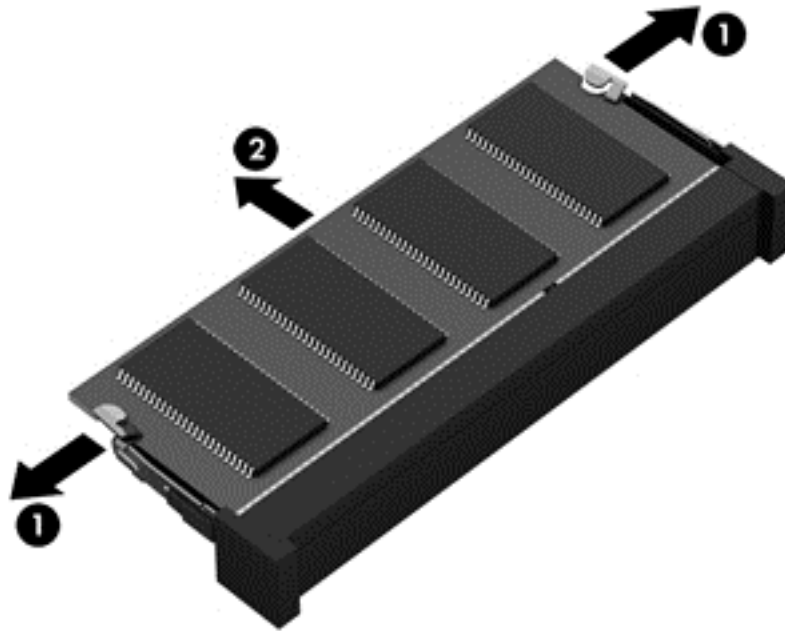

To protect a memory module after removal, place it in an electrostatic-safe container.

8. Insert a new memory module:

CAUTION: To prevent damage to the memory module, hold the memory module by the edges only. Do not touch the components on the memory module.

- a. Align the notched edge **(1)** of the memory module with the tab in the memory module slot.
- b. With the memory module at a 45-degree angle from the surface of the memory module compartment, press the module into the memory module slot **(2)** until it is seated.
- c. Gently press the memory module **(3)** down, applying pressure to both the left and right edges of the module, until the retention clips snap into place.

CAUTION: To prevent damage to the memory module, be sure that you do not bend the module.

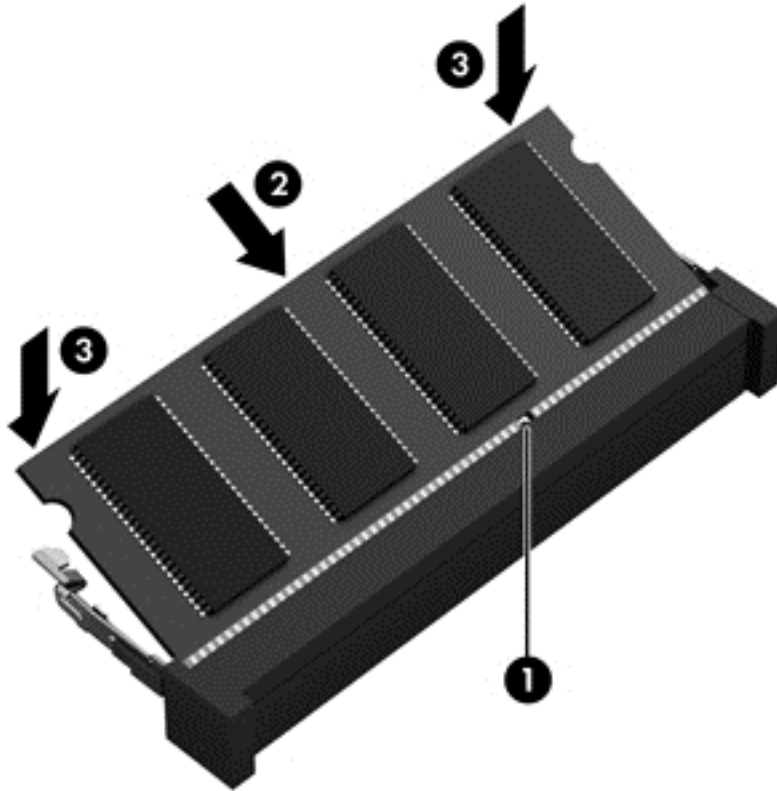

9. Replace the service door:

- a. Align the tabs on the service door with the notches on the computer (1), and slide the service door down until it snaps into place (2).
- b. Insert and tighten the service door screw (3) to hold the service door in place.

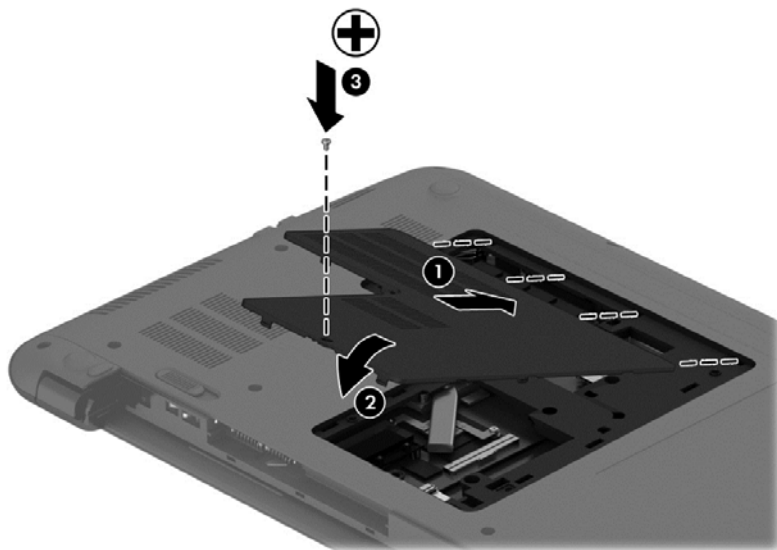

10. Replace the battery.

11. Turn the computer right-side up, and then reconnect external power and external devices.

12. Turn on the computer.

Updating programs and drivers

HP recommends that you update your programs and drivers on a regular basis to the latest versions. Updates can resolve issues and bring new features and options to your computer. Technology is always changing, and updating programs and drivers allows your computer to run the latest technology available.

Go to <http://www.hp.com/support> to download the latest versions of HP programs and drivers. In addition, register to receive automatic update notifications when they become available.

Cleaning your computer

Use the following products to safely clean your computer:

- Dimethyl benzyl ammonium chloride 0.3 percent maximum concentration (For example: Disposable wipes, which come in a variety of brands.)
- Alcohol-free glass-cleaning fluid
- Water with mild soap solution
- Dry microfiber cleaning cloth or a chamois (static-free cloth without oil)
- Static-free cloth wipes

⚠ CAUTION: Avoid strong cleaning solvents that can permanently damage your computer. If you are not sure that a cleaning product is safe for your computer, check the product contents to make sure that ingredients such as alcohol, acetone, ammonium chloride, methylene chloride, and hydrocarbons are not included in the product.

Fibrous materials, such as paper towels, can scratch the computer. Over time, dirt particles and cleaning agents can get trapped in the scratches.

Cleaning procedures

Follow the procedures in this section to safely clean your computer.

⚠ WARNING! To prevent electric shock or damage to components, do not attempt to clean your computer while it is turned on.

Turn off the computer.

Disconnect AC power.

Disconnect all powered external devices.

⚠ CAUTION: To prevent damage to internal components, do not spray cleaning agents or liquids directly on any computer surface. Liquids dripped on the surface can permanently damage internal components.

Cleaning the display (All-in-Ones or Notebooks)

Gently wipe the display using a soft, lint-free cloth moistened with an *alcohol-free* glass cleaner. Be sure that the display is dry before closing the display.

Cleaning the sides or cover

To clean the sides or cover, use a soft microfiber cloth or chamois moistened with one of the cleaning solutions listed previously or use an acceptable disposable wipe.

 **NOTE:** When cleaning the cover of the computer, use a circular motion to aid in removing dirt and debris.

Cleaning the TouchPad, keyboard, or mouse

 **WARNING!** To reduce the risk of electric shock or damage to internal components, do not use a vacuum cleaner attachment to clean the keyboard. A vacuum cleaner can deposit household debris on the keyboard surface.

 **CAUTION:** To prevent damage to internal components, do not allow liquids to drip between the keys.

- To clean the TouchPad, keyboard, or mouse, use a soft microfiber cloth or a chamois moistened with one of the cleaning solutions listed previously or use an acceptable disposable wipe.
- To prevent keys from sticking and to remove dust, lint, and particles from the keyboard, use a can of compressed air with a straw extension.

Traveling with or shipping your computer

If you have to travel with or ship your computer, here are some tips to keep in mind to keep your equipment safe.

- Prepare the computer for traveling or shipping:
 - Back up your information to an external drive.
 - Remove all discs and all external memory, such as memory cards, from the computer.
 - Remove any media from external devices before disconnecting external devices.
- Take along a backup of your information. Keep the backup separate from the computer.
- When traveling by air, carry the computer as hand luggage; do not check it in with the rest of your luggage.

 **CAUTION:** Perform this action before shipping, storing, or traveling with a drive. This will help reduce the risk of damage to the computer, damage to a drive, or loss of information.

- Turn off and then disconnect all external devices.
- Shut down the computer.
- If you plan to use the computer during a flight, listen for the in-flight announcement that tells you when you are allowed to use your computer. In-flight computer use is at the discretion of the airline.
- If you are shipping the computer or a drive, use suitable protective packaging and label the package “FRAGILE.”

- If the computer has a wireless device installed, the use of these devices may be restricted in some environments. Such restrictions may apply aboard aircraft, in hospitals, near explosives, and in hazardous locations. If you are uncertain of the policy that applies to the use of a particular device, ask for authorization to use your computer before you turn it on.
- If you are traveling internationally, follow these suggestions:
 - Check the computer-related customs regulations for each country or region on your itinerary.
 - Check the power cord and adapter requirements for each location in which you plan to use the computer. Voltage, frequency, and plug configurations vary.

 **WARNING!** To reduce the risk of electric shock, fire, or damage to the equipment, do not attempt to power the computer with a voltage converter kit sold for appliances.

9 Securing your computer and information

Computer security is essential for protecting the confidentiality, integrity, and availability of your information. Standard security solutions provided by the Windows operating system, HP applications, the non-Windows Setup Utility (BIOS), and other third-party software can help protect your computer from a variety of risks, such as viruses, worms, and other types of malicious code.



IMPORTANT: Some security features listed in this chapter may not be available on your computer.

Computer risk	Security feature
Unauthorized use of the computer	Power-on password
Computer viruses	Antivirus software
Unauthorized access to data	Firewall software
Unauthorized access to Setup Utility (BIOS) settings and other system identification information	Administrator password
Ongoing or future threats to the computer	Software updates
Unauthorized access to a Windows user account	User password
Unauthorized removal of the computer	Security cable lock

Locating your security software

HP Security Assistant (select models only) provides a starting location for quick access to a collection of security software applications that are organized by task. Instead of searching for each application through the Start menu and Control Panel, HP Security Assistant allows you to access the applications for the following security tasks:

- Setting up Internet and antivirus security.
- Backing up and recovering files.
- Managing passwords, user accounts, and parental controls.
- Maintaining your computer and installing the latest HP and Windows updates.

To open HP Security Assistant, select **Start > All Programs > Security and Protection > HP Security Assistant**.

Using passwords

A password is a group of characters that you choose to secure your computer information and to protect online transactions. Several types of passwords can be set. For example, when you set up your computer for the first time, you were asked to create a user password to secure your computer. Additional passwords can be set in Windows or in the HP Setup Utility (BIOS) that is preinstalled on your computer.

You may find it helpful to use the same password for a Setup Utility (BIOS) feature and for a Windows security feature.

Use the following tips for creating and saving passwords:

- To reduce the risk of being locked out of the computer, record each password and store it in a secure place away from the computer. Do not store passwords in a file on the computer.
- When creating passwords, follow requirements set by the program.
- Change your passwords at least every three months.
- An ideal password is long and has letters, punctuation, symbols, and numbers.
- Before you send your computer for service, back up your files, delete confidential files, and then remove all password settings.

For additional information about Windows passwords, such as screen-saver passwords, select **Start > Help and Support**.

Setting Windows passwords

Password	Function
User password	Protects access to a Windows user account. You may also set up your computer to require the user password to exit Sleep or Hibernation. See Setting password protection on wakeup on page 39 for more information.
Administrator password	Protects administrator-level access to computer contents. NOTE: This password cannot be used to access Setup Utility (BIOS) contents.

Setting Setup Utility (BIOS) passwords

Password	Function
Administrator password	<ul style="list-style-type: none">• Must be entered each time you access Setup Utility (BIOS).• If you forget your administrator password, you cannot access Setup Utility (BIOS). <p>NOTE: The administrator password can be used in place of the power-on password.</p> <p>NOTE: Your administrator password is not interchangeable with an administrator password set in Windows, nor is it revealed as it is set, entered, changed, or deleted.</p> <p>NOTE: If you enter the power-on password at the first password check before the “Press the ESC key for Startup Menu” message is displayed, you must enter the administrator password to access Setup Utility (BIOS).</p>
Power-on password	<ul style="list-style-type: none">• Must be entered each time you turn on or restart the computer, or exit Hibernation.• If you forget your power-on password, you cannot turn on or restart the computer, or exit Hibernation. <p>NOTE: The administrator password can be used in place of the power-on password.</p> <p>NOTE: A power-on password is not revealed as it is set, entered, changed, or deleted.</p>

To set, change, or delete an administrator or power-on password in Setup Utility (BIOS):

1. Open Setup Utility (BIOS) by turning on or restarting the computer. While the “Press the ESC key for Startup Menu” message is displayed in the lower-left corner of the screen, press **esc**.
2. Use the arrow keys and follow the on-screen instructions. When the Startup Menu is displayed, press **f10**.
3. Use the arrow keys to select **Security**, and then follow the on-screen instructions.

Your changes take effect when the computer restarts.

Using Internet security software

When you use your computer to access email, a network, or the Internet, you potentially expose your computer to computer viruses, spyware, and other online threats. To help protect your computer, Internet security software that includes antivirus and firewall features may be preinstalled on your computer as a trial offer. To provide ongoing protection against newly discovered viruses and other security risks, security software must be kept up to date. It is strongly recommended that you upgrade the security software trial offer or purchase the software of your choice in order to fully protect your computer.

Using antivirus software

Computer viruses can disable programs, utilities, or the operating system, or cause them to function abnormally. Antivirus software can detect most viruses, destroy them, and in most cases, repair any damage they have caused.

For more information about computer viruses, type `viruses` in the Search box in Help and Support.

Using firewall software

Firewalls are designed to prevent unauthorized access to a system or network. A firewall can be software you install on your computer and/or network, or it can be a combination of both hardware and software.

There are two types of firewalls to consider:

- Host-based firewalls—Software that protects only the computer it is installed on.
- Network-based firewalls—Installed between your DSL or cable modem and your home network to protect all the computers on the network.

When a firewall is installed on a system, all data sent to and from the system is monitored and compared with a set of user-defined security criteria. Any data that does not meet those criteria is blocked.

Installing software updates

HP, Microsoft Windows, and third-party software installed on your computer should be regularly updated to correct security problems and improve software performance. For more information, see [Updating programs and drivers on page 53](#).

Installing Windows security updates

Updates to the operating system and other software may have become available after the computer left the factory. Microsoft sends out alerts regarding critical updates. To protect the computer from security breaches and computer viruses, install all critical updates from Microsoft as soon as you receive an alert.

To be sure that all available updates are installed on the computer, observe these guidelines:

- Run Windows Update as soon as possible after you set up your computer. Select **Start > All Programs > Windows Update**.
- Run Windows Update monthly thereafter.
- Obtain updates to Windows and other Microsoft programs, as they are released, from the Microsoft website and through the updates link in Help and Support.

Installing HP and third-party software updates

HP recommends that you regularly update the software and drivers that were originally installed on your computer. To download the latest versions, go to <http://www.hp.com/support>. At this location, you can also register to receive automatic update notifications when they become available.

If you have installed third-party software after you purchased your computer, regularly update the software. Software companies provide software updates to their products to correct security problems and improve functionality of the software.

Securing your wireless network

When you set up your wireless network, always enable security features. For more information, see [Protecting your WLAN on page 21](#).

Backing up your software applications and information

Regularly back up your software applications and information to protect them from being permanently lost or damaged through a virus attack or a software or hardware failure. For more information, see [Backing up, restoring, and recovering on page 64](#).

Using an optional security cable lock

A security cable lock, which is purchased separately, is designed to act as a deterrent, but it may not prevent the computer from being mishandled or stolen. Security cable locks are only one of several methods that should be employed as part of a complete security solution to help maximize theft protection.

The security cable slot on your computer may look slightly different from the illustration in this section. For the location of the security cable slot on your computer, see [Getting to know your computer on page 3](#).

1. Loop the security cable lock around a secured object.
2. Insert the key (1) into the security cable lock (2).
3. Insert the security cable lock into the security cable slot on the computer (3), and then lock the security cable lock with the key.

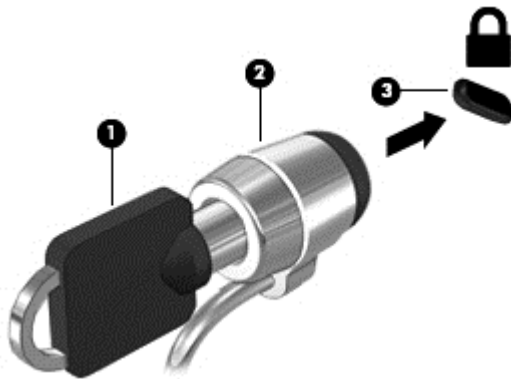

4. Remove the key and keep it in a safe place.

10 Using Computer Setup (BIOS) and HP PC Hardware Diagnostics (UEFI)

Setup Utility, or Basic Input/Output System (BIOS), controls communication between all the input and output devices on the system (such as disk drives, display, keyboard, mouse, and printer). Setup Utility (BIOS) includes settings for the types of devices installed, the startup sequence of the computer, and the amount of system and extended memory.

Starting Setup Utility (BIOS)

To start Setup Utility (BIOS), follow these steps:

1. Turn on or restart the computer, and then press **esc** while the “Press the ESC key for Startup Menu” message is displayed at the bottom of the screen.
2. Press **f10** to enter Setup Utility (BIOS).

Information about how to navigate in Setup Utility (BIOS) is located at the bottom of the screen.



NOTE: Use extreme care when making changes in Setup Utility (BIOS). Errors can prevent the computer from operating properly.

Updating the BIOS

Updated versions of the BIOS may be available on the HP website.

Most BIOS updates on the HP website are packaged in compressed files called *SoftPaqs*.

Some download packages contain a file named *Readme.txt*, which contains information regarding installing and troubleshooting the file.

Determining the BIOS version

To determine whether available BIOS updates contain later BIOS versions than those currently installed on the computer, you need to know the version of the system BIOS currently installed.

BIOS version information (also known as *ROM date* and *System BIOS*) can be displayed by pressing **fn+esc** (if you are already in Windows) or by using Setup Utility (BIOS).

1. Start Setup Utility (BIOS).
2. Use the arrow keys to select **Main**.
3. To exit Setup Utility (BIOS) without saving your changes, use the tab key and the arrow keys to select **Exit > Exit Discarding Changes**, and then press **enter**.

Downloading a BIOS update

 **CAUTION:** To reduce the risk of damage to the computer or an unsuccessful installation, download and install a BIOS update only when the computer is connected to reliable external power using the AC adapter. Do not download or install a BIOS update while the computer is running on battery power, docked in an optional docking device, or connected to an optional power source. During the download and installation, follow these instructions:

Do not disconnect power from the computer by unplugging the power cord from the AC outlet.

Do not shut down the computer or initiate Sleep or Hibernation.

Do not insert, remove, connect, or disconnect any device, cable, or cord.

1. Select **Start > Help and Support > Maintain**.
2. Follow the on-screen instructions to identify your computer and access the BIOS update you want to download.
3. At the download area, follow these steps:
 - a. Identify the BIOS update that is later than the BIOS version currently installed on your computer. Make a note of the date, name, or other identifier. You may need this information to locate the update later, after it has been downloaded to your hard drive.
 - b. Follow the on-screen instructions to download your selection to the hard drive.

Make a note of the path to the location on your hard drive where the BIOS update is downloaded. You will need to access this path when you are ready to install the update.

 **NOTE:** If you connect your computer to a network, consult the network administrator before installing any software updates, especially system BIOS updates.

BIOS installation procedures vary. Follow any instructions that are displayed on the screen after the download is complete. If no instructions are displayed, follow these steps:

1. Open Windows Explorer by selecting **Start > Computer**.
2. Double-click your hard drive designation. The hard drive designation is typically Local Disk (C:).
3. Using the hard drive path you recorded earlier, open the folder on your hard drive that contains the update.
4. Double-click the file that has an .exe extension (for example, *filename.exe*).
The BIOS installation begins.
5. Complete the installation by following the on-screen instructions.

 **NOTE:** After a message on the screen reports a successful installation, you can delete the downloaded file from your hard drive.

Using System Diagnostics

System Diagnostics allows you to run diagnostic tests to determine if the computer hardware is functioning properly.

To start System Diagnostics:

1. Turn on or restart the computer. While the “Press the ESC key for Startup Menu” message is displayed in the lower-left corner of the screen, press **esc**. When the Startup Menu is displayed, press **f2**.
2. Click the diagnostic test you want to run, and then follow the on-screen instructions.

 **NOTE:** If you need to stop a diagnostics test while it is running, press **esc**.

Using HP PC Hardware Diagnostics (UEFI) (select models only)

HP PC Hardware Diagnostics is a Unified Extensible Firmware Interface (UEFI) that allows you to run diagnostic tests to determine if the computer hardware is functioning properly. The tool runs outside of the operating system to isolate hardware failures from issues that may be caused by the operating system or other software components.

To start HP PC Hardware Diagnostics UEFI:

1. Turn on or restart the computer, quickly press **esc**, and then press **f2**.

After pressing **f2**, the BIOS searches three places for the HP PC Hardware Diagnostics (UEFI) tools in the following order:

- a. Connected USB drive

 **NOTE:** To download the HP PC Hardware Diagnostics (UEFI) tool to a USB drive, see [Downloading HP PC Hardware Diagnostics \(UEFI\) to a USB device on page 63](#).

- b. Hard drive
- c. BIOS

2. Click the type of diagnostic test you want to run, and then follow the on-screen instructions.

 **NOTE:** If you need to stop a diagnostic test while it is running, press **esc**.

Downloading HP PC Hardware Diagnostics (UEFI) to a USB device

 **NOTE:** The HP PC Hardware Diagnostics (UEFI) download instructions are provided in English only.

1. Go to <http://www.hp.com>.
2. Click **Support & Drivers**, and then click the **Drivers & Software** tab.
3. Enter the product name in the text box, and then click **Search**.
4. Select your computer model, and then select your operating system.
5. In the Diagnostic section, click **HP UEFI Support Environment**.

– or –

Click **Download**, and then select **Run**.

11 Backing up, restoring, and recovering

Your computer includes tools provided by the operating system and HP to help you safeguard your information and retrieve it if ever needed.

Creating backups

1. Use HP Recovery Manager to create recovery media immediately after you set up the working computer.
2. As you add hardware and software programs, create system restore points.
3. As you add photos, video, music, and other personal files, create a backup of your system and personal information.

Creating recovery media to recover the original system

After you successfully set up the computer, you should create recovery discs or a recovery flash drive using HP Recovery Manager. You will need these recovery discs or recovery flash drive to perform a system recovery should the hard drive become corrupted. A system recovery reinstalls the original operating system, and then configures the settings for the default programs.

What you need to know

- Only one set of recovery media can be created. Handle these recovery tools carefully, and keep them in a safe place.
- HP Recovery Manager examines the computer and determines the required storage capacity for the flash drive or the number of blank DVD discs that will be required.

Use DVD-R, DVD+R, DVD-R DL, DVD+R DL discs or a flash drive. Do not use rewriteable discs such as CD±RW, DVD±RW, double-layer DVD±RW, and BD-RE (rewritable Blu-ray) discs; they are not compatible with HP Recovery Manager software.
- You can use an optional external optical drive (purchased separately) to create recovery discs, or you can obtain recovery discs for your computer from support through the HP website. Go to <http://www.hp.com/support>, select your country or region, and follow the on-screen instructions. If you use an external optical drive, it must be connected directly to a USB port on the computer, not to a USB port on an external device, such as a USB hub.
- Be sure that the computer is connected to AC power before you begin creating the recovery media.
- The creation process can take up to an hour or more. Do not interrupt the creation process.
- Store the recovery media in a safe location, separate from the computer.
- If necessary, you can exit the program before you have finished creating the recovery media. The next time you open HP Recovery Manager, you will be prompted to continue the process.

Creating the recovery media

1. Select **Start** and type `recovery` in the search field. Select **Recovery Manager** from the list. Allow the action to continue, if prompted.
2. Click **Recovery Media Creation**.
3. Follow the on-screen instructions to continue.

To recover, see [Recovering the original system using HP Recovery Manager on page 67](#).

Creating system restore points

A system restore point is a snapshot of certain hard drive contents saved by Windows System Restore at a specific time. A restore point contains information such as registry settings that Windows uses. Restoring to a previous restore point allows you to reverse changes that have been made to the system since the restore point was created.

Restoring to an earlier system restore point does not affect data files saved or emails created since the last restore point, but it does affect software you may have installed.

For example, if you download a photo from a digital camera and then restore the computer to the state it was on the previous day, the photo remains on the computer.

However, if you install photo viewing software and then restore your computer to the state it was on the previous day, the software will be uninstalled, and you won't be able to use it.

What you need to know

- If you restore to a restore point and then change your mind, you can undo the restoration.
- You should create system restore points:
 - Before you add or change software or hardware
 - Periodically, whenever the computer is running normally
- System Restore also saves shadow copies of files that have been changed since the last restore point was created. For more information about using shadow copies to restore, see Help and Support.

Creating a system restore point

1. Select **Start > Control Panel > System and Security > System**.
2. In the left pane, click **System Protection**.
3. Click the **System Protection** tab.
4. Click **Create**, and follow the on-screen instructions.

To restore, see [Restoring to a previous system restore point on page 67](#).

Backing up system and personal information

Your computer stores information that is important to you, such as files, emails, and photos, and you will want to keep that information even if you download a virus or the system stops working properly. How completely you are able to recover your files depends on how recent your backup is. As you add new software and data files, you should create backups on a regular basis.

Tips for a successful backup

- Number backup discs before inserting them into the optical drive.
- Store personal files in the Documents, Music, Pictures, and Videos libraries, and back up these folders periodically.
- Save customized settings in a window, toolbar, or menu bar by taking a screen shot of your settings. The screen shot can be a time-saver if you have to re-enter your preferences.

To create a screen shot:

1. Display the screen you want to save.
2. Copy the screen image:
To copy only the active window, press **alt+prt sc**.
To copy the entire screen, press **prt sc**.
3. Open a word-processing document or graphics editing program, and then select **Edit > Paste**. The screen image is added to the document.
4. Save and print the document.

What you need to know

- You can back up your information to an optional external hard drive, a flash drive, a network drive, or discs.
- Connect the computer to AC power during backups.
- Allow enough time for the backup. Depending on files sizes, it may take more than an hour.
- Verify the amount of free space on your backup storage device before you back up.
- You should back up:
 - Before adding or changing software or hardware.
 - Before the computer is repaired or restored.
 - On a regular schedule to be sure you have recent copies of personal information.
 - After you add many files—for example, if you saved videos from a birthday party.
 - Before using antivirus software to remove a malicious program.
 - After adding information that is hard to replace, such as pictures, videos, music, project files, or data records.

Creating a backup using Windows Backup and Restore

Windows allows you to back up files using Windows Backup and Restore. You can select the level you want to back up, from individual folders to drives. The backups are compressed to save space. To back up:

1. Select **Start > Control Panel > System and Security > Backup and Restore**.
2. Follow the on-screen instructions to schedule and create a backup.



NOTE: Windows includes the User Account Control feature to improve the security of the computer. You may be prompted for your permission or password for tasks such as installing software, running utilities, or changing Windows settings. See Help and Support for more information.

To restore, see [Restoring specific files using Windows Backup and Restore on page 67](#).

Restore and recovery

Restoring to a previous system restore point

Sometimes installing a software program causes your computer or Windows to behave unpredictably. Usually uninstalling the software fixes the problems. If uninstalling does not fix the problems, you can restore the computer to a previous system restore point (created at an earlier date and time).

To restore to a previous system restore point, when the computer was running correctly:

1. Select **Start > Control Panel > System and Security > System**.
2. In the left pane, click **System Protection**.
3. Click the **System Protection** tab.
4. Click **System Restore**, and follow the on-screen instructions.

Restoring specific files

If files are accidentally deleted from the hard disk and they can no longer be restored from the Recycle Bin, or if files become corrupt, restoring specific files is useful. Restoring specific files is also useful if you ever choose to recover the original system using HP Recovery Manager. You can only restore specific files that you have backed up before.

Restoring specific files using Windows Backup and Restore

Windows allows you to restore files that were backed up using Windows Backup and Restore:

1. Select **Start > Control Panel > System and Security > Backup and Restore**.
2. Follow the on-screen instructions to restore your backup.

 **NOTE:** Windows includes the User Account Control feature to improve the security of the computer. You may be prompted for your permission or password for tasks such as installing software, running utilities, or changing Windows settings. See Help and Support for more information.

Recovering the original system using HP Recovery Manager

HP Recovery Manager software allows you to repair or recover the computer to its original factory state.

What you need to know

- HP Recovery Manager recovers only software that was installed at the factory. For software not provided with this computer, you must either download the software from the manufacturer's website or reinstall the software from the disc provided by the manufacturer.
- A system recovery should be used as a final attempt to correct computer issues. If you have not already tried restore points (see [Restoring to a previous system restore point on page 67](#)) and partial restores (see [Restoring specific files on page 67](#)), try them before using HP Recovery Manager to recover your system.
- A system recovery must be performed if the computer hard drive fails or if all attempts to correct any functional computer issues fail.

- If the recovery media do not work, you can obtain recovery discs for your system from support through the HP website. Go to <http://www.hp.com/support>, select your country or region, and follow the on-screen instructions.
- The Minimized Image Recovery option is recommended for advanced users only. All hardware-related drivers and software are re-installed, but other software applications are not. Do not interrupt the process until it is complete, otherwise the recovery will fail.

Recovering using HP Recovery partition (select models only)

The HP Recovery partition (select models only), allows you to restore your system without the need for recovery discs or a recovery flash drive. This type of recovery can only be used if the hard drive is still working.

To check for the presence of a recovery partition, select **Start**, right-click **Computer** then select **Manage > Disk Management**. If the recovery partition is present, a Recovery drive is listed in the window.



NOTE: Recovery discs have been included if your computer did not ship with a recovery partition.

1. Access HP Recovery Manager in either of the following ways:
 - Select **Start** and type `recovery` in the search field. Select **Recovery Manager** from the list.
 - or –
 - Turn on or restart the computer, and then press `esc` while the “Press the ESC key for Startup Menu” message is displayed at the bottom of the screen. Then press `f11` while the “F11 (System Recovery)” message is displayed on the screen.
2. Click **System Recovery** in the **HP Recovery Manager** window.
3. Follow the on-screen instructions.

Recovering using the recovery media

1. If possible, back up all personal files.
2. Insert the first recovery disc into the optical drive on your computer or an optional external optical drive, and then restart the computer.

– or –

Insert the recovery flash drive into a USB port on your computer, and then restart the computer.



NOTE: If the computer does not automatically restart in HP Recovery Manager, change the computer boot order. See [Changing the computer boot order on page 69](#).

3. Press `f9` at system bootup.
4. Select the optical drive or the flash drive.
5. Follow the on-screen instructions.

Changing the computer boot order

To change the boot order for recovery discs:

1. Restart the computer.
2. Press **esc** while the computer is restarting, and then press **f9** for boot options.
3. Select **Internal CD/DVD ROM Drive** from the boot options window.

To change the boot order for a recovery flash drive:

1. Insert the flash drive into a USB port.
2. Restart the computer.
3. Press **esc** while the computer is restarting, and then press **f9** for boot options.
4. Select the flash drive from the boot options window.

12 Specifications

Input power

The power information in this section may be helpful if you plan to travel internationally with the computer.

The computer operates on DC power, which can be supplied by an AC or a DC power source. The AC power source must be rated at 100–240 V, 50–60 Hz. Although the computer can be powered from a standalone DC power source, it should be powered only with an AC adapter or a DC power source supplied and approved by HP for use with this computer.

The computer can operate on DC power within the following specifications. Operating voltage and current varies by platform.

Input power	Rating
Operating voltage and current	19.5 V dc @ 2.31 A – 45 W
	19.5 V dc @ 3.33 A – 65 W
	19.5 V dc @ 4.62 A – 90 W

DC plug of external HP power supply



 **NOTE:** This product is designed for IT power systems in Norway with phase-to-phase voltage not exceeding 240 V rms.

 **NOTE:** The computer operating voltage and current can be found on the system regulatory label.

Operating environment

Factor	Metric	U.S.
Temperature		
Operating	5°C to 35°C	41°F to 95°F
Nonoperating	-20°C to 60°C	-4°F to 140°F
Relative humidity (noncondensing)		
Operating	10% to 90%	10% to 90%
Nonoperating	5% to 95%	5% to 95%
Maximum altitude (unpressurized)		
Operating	-15 m to 3,048 m	-50 ft to 10,000 ft
Nonoperating	-15 m to 12,192 m	-50 ft to 40,000 ft

13 Troubleshooting and support

- [Troubleshooting](#)
- [Contacting support](#)

Troubleshooting

Wireless connection problems

Some possible causes for wireless connection problems include the following:

- Wireless device is not turned on.
- Wireless device is not installed correctly or has been disabled.
- Wireless device encountered interference from other devices.
- Wireless device or router hardware has failed.

 **NOTE:** Wireless networking devices are included with select computer models only. If wireless networking is not listed in the feature list on the side of the original computer package, you may add wireless networking capability to the computer by purchasing a wireless networking device.

Cannot connect to a WLAN

If you have a problem connecting to a WLAN, confirm that the integrated WLAN device is turned on and properly installed on your computer.

1. If the wireless light is off or amber, press the wireless button, wireless switch, or wireless key to turn the wireless device on.
2. Then try connecting to the WLAN again.

If you are still unable to connect, follow the steps below.

1. Select **Start > Control Panel > System and Security**.
2. In the System area, click **Device Manager**.
3. Click the arrow next to **Network adapters** to expand the list and show all adapters.
4. Identify the WLAN device from the Network adapters list. The listing for a WLAN device may include the term *wireless*, *wireless LAN*, *WLAN*, or *802.11*.

If no WLAN device is listed, either your computer does not have an integrated WLAN device, or the driver for the WLAN device is not properly installed.

For more information about troubleshooting WLANs, see the website links provided in Help and Support.

Cannot connect to a preferred network

You may not be able to connect to a preferred network because it is a security-enabled WLAN. You must have the security code to connect to this type of WLAN. See the next section for additional information.

If entering a security code is not the problem, you may have a corrupted WLAN connection. Many times, Windows can automatically repair a corrupted WLAN connection.

- If there is a network status icon in the notification area, at the far right of the taskbar, right-click the icon, and then click **Troubleshoot problems**.

Windows resets your network device and attempts to reconnect to one of the preferred networks.

- If there is no network status icon in the notification area, follow these steps:
 1. **Start > Control Panel > Network and Internet > Network and Sharing Center.**
 2. Click **Troubleshoot problems** and select the network you wish to repair.

Current network security codes are unavailable

If you are prompted for a security code (or network key) or a name (SSID) when connecting to a WLAN, the network is protected by security. You must have the current codes to make a connection on a secure network. The SSID and security code are alphanumeric codes that you enter into your computer to identify your computer to the network.

- For a network connected to your personal wireless router, review the router user guide for instructions on setting up the same codes on both the router and the WLAN device.
- For a private network, such as a network in an office or at a public Internet chat room, contact the network administrator to obtain the codes, and then enter the codes when prompted to do so.

Some networks change the SSID or network keys used in their routers or access points on a regular basis to improve security. You must change the corresponding code in your computer accordingly.

If you are provided with new wireless network keys and SSID for a network, and if you have previously connected to that network, follow the steps below to connect to the network:

1. Select **Start > Control Panel > Network and Internet > Network and Sharing Center**.
2. In the left panel, click **Manage wireless networks**.

A list showing the available WLANs is displayed. If you are in a hotspot where several WLANs are active, several will be displayed.

3. Select the network in the list, right-click the network, and then click **Properties**.



NOTE: If the network you want is not listed, check with the network administrator to be sure that the router or access point is operating.

4. Click the **Security** tab and enter the correct wireless encryption data into the **Network security key** box.
5. Click **OK** to save these settings.

WLAN connection is very weak

If the connection is very weak, or if your computer cannot make a connection to a WLAN, minimize interference from other devices, as follows:

- Move your computer closer to the wireless router or access point.
- Temporarily disconnect wireless devices such as a microwave, cordless phone, or cellular phone to be sure that other wireless devices are not interfering.

If the connection does not improve, try forcing the device to reestablish all connection values:

1. Select **Start > Control Panel > Network and Internet > Network and Sharing Center**.
2. In the left panel, click **Manage wireless networks**.

A list showing the available WLANs is displayed. If you are in a hotspot where several WLANs are active, several will be displayed.

3. Click a network, and then click **Remove**.

Cannot connect to the wireless router

If you are trying to connect to the wireless router and are unsuccessful, reset the wireless router by removing power from the router for 10 to 15 seconds.

If the computer still cannot make a connection to a WLAN, restart the wireless router. For details, see the router manufacturer's instructions.

Network status icon is not displayed

If the network status icon is not displayed in the notification area after you configure the WLAN, the software driver is either missing or corrupted. A Windows "Device not Found" error message may also be displayed. The driver must be reinstalled.

Get the latest version of the WLAN device software and drivers for your computer from the HP website at <http://www.hp.com>. If the WLAN device you are using was purchased separately, consult the manufacturer's website for the latest software.

To get the latest version of the WLAN device software for your computer, follow these steps:

1. Open your Internet browser and go to <http://www.hp.com/support>.
2. Select your country or region.
3. Click the option for software and driver downloads, and then type your computer model number in the search box.
4. Press **enter**, and then follow the on-screen instructions.



NOTE: If the WLAN device you are using was purchased separately, consult the manufacturer's website for the latest software.

Audio problems

To check the audio functions on your computer, follow these steps:

1. Select **Start > Control Panel > Hardware and Sound > Sound**.
2. When the Sound window opens, click the **Sounds** tab. Under Program Events, select any sound event, such as a beep or alarm, and click the **Test** button.

You should hear sound through the speakers or through connected headphones.

To check the recording functions on your computer, follow these steps:

1. Select **Start > All Programs > Accessories > Sound Recorder**.
2. Click **Start Recording** and speak into the microphone. Save the file to your desktop.
3. Open a multimedia program and play back the sound.

To confirm or change the audio settings on your computer, select **Start > Control Panel > Hardware and Sound > Sound**.

Power management problems

Some possible causes for power management problems include the following:

- Low battery levels
- AC adapter problems

Resolving a low battery level

Resolving a low battery level when external power is available

- Connect an AC adapter.
- Connect an optional docking or expansion device.
- Connect an optional power adapter purchased as an accessory from HP.

Resolving a low battery level when no power source is available

- Initiate Hibernation.
- Save your work and shut down the computer.

Resolving a low battery level when the computer cannot exit Hibernation

When the computer lacks sufficient power to exit Hibernation, follow these steps:

1. Replace the discharged user-replaceable battery with a charged battery, or connect the AC adapter to the computer and to external power.
2. Exit Hibernation by pressing the power button.

Troubleshooting an AC adapter

Test the AC adapter if the computer exhibits any of the following symptoms when it is connected to AC power:

- The computer does not turn on.
- The display does not turn on.
- The power lights are off.

To test the AC adapter:

1. Shut down the computer.
2. Remove the battery from the computer. See [Removing a user-replaceable battery on page 40](#).

3. Connect the AC adapter to the computer, and then plug it into an AC outlet.
4. Turn on the computer.
 - If the power lights turn *on*, the AC adapter is working properly.
 - If the power lights remain *off*, check the connection from the AC adapter to the computer and the connection from the AC adapter to the AC outlet to make sure the connections are secure.
 - If the connections are secure and the power lights remain *off*, the AC adapter is not functioning and should be replaced.

Contact support for information about obtaining a replacement AC power adapter.

Contacting support

If the information provided in this user guide or in Help and Support does not answer your questions, you can contact support at <http://www.hp.com/go/contactHP>.



NOTE: For worldwide support, click **Contact HP worldwide** on the left side of the page, or go to http://welcome.hp.com/country/us/en/wwcontact_us.html.

Here you can:

- Chat online with an HP technician.



NOTE: When technical support chat is not available in a particular language, it is available in English.

- Email Support.
- Find Support worldwide telephone numbers.
- Locate an HP service center.

14 Electrostatic Discharge

Electrostatic discharge is the release of static electricity when two objects come into contact—for example, the shock you receive when you walk across the carpet and touch a metal door knob.

A discharge of static electricity from fingers or other electrostatic conductors may damage electronic components. To prevent damage to the computer, damage to a drive, or loss of information, observe these precautions:

- If removal or installation instructions direct you to unplug the computer, unplug it after being properly grounded and before removing a cover.
- Keep components in their electrostatic-safe containers until you are ready to install them.
- Avoid touching pins, leads, and circuitry. Handle electronic components as little as possible.
- Use nonmagnetic tools.
- Before handling components, discharge static electricity by touching an unpainted metal surface of the component.
- If you remove a component, place it in an electrostatic-safe container.

If you need more information about static electricity or assistance with component removal or installation, contact support.

Index

- A**
 - AC adapter 5
 - action keys
 - decrease screen brightness 33
 - Help and Support 33
 - identifying 13, 14
 - increase screen brightness 33
 - next track or section 33
 - play, pause, resume 33
 - previous track or section 33
 - switch screen image 33
 - volume down 33
 - volume mute 33
 - volume up 33
 - wireless 33
 - antivirus software, using 58
 - audio functions, checking 28
 - audio, using 27
 - audio-in (microphone) jack 6, 25, 27
 - audio-out (headphone) jack 6, 25, 27
- B**
 - backing up software and information 60
 - backups 64
 - battery
 - conserving power 42
 - disposing 43
 - replacing 43
 - storing 43
 - battery bay, identifying 15
 - battery information, finding 42
 - battery lock latch, identifying 15
 - battery power 40
 - battery release latch 15
 - battery temperature 43
 - best practices 1
 - BIOS
 - determining version 61
 - downloading an update 62
 - updating 61
 - Bluetooth device 19, 22
 - Bluetooth label 18
 - boot order
 - changing 69
 - bottom 18
 - buttons
 - left TouchPad 9, 34
 - optical drive eject 4
 - power 12
 - right TouchPad 9, 34
- C**
 - cables
 - USB 46
 - caps lock light, identifying 10, 11
 - caring for your computer 53
 - Certificate of Authenticity label 18
 - checking audio functions 28
 - cleaning your computer 53
 - components
 - bottom 15
 - display 7
 - front 3
 - left side 5
 - power button 12
 - right side 4
 - top 9
 - computer, traveling 43
 - configuring audio for HDMI 30
 - connecting to a WLAN 22
 - connector, power 5
 - conservation, power 42
 - corporate WLAN connection 22
 - critical battery level 43
 - CyberLink PowerDVD 31
- D**
 - deleted files
 - restoring 67
 - Disk Cleanup software 49
 - Disk Defragmenter software 48
 - drive media 38
- E**
 - electrostatic discharge 77
 - esc key, identifying 13, 14
 - external AC power, using 43
 - external devices 46
 - external monitor port
 - connecting 29
 - identifying 5, 25, 27
- F**
 - firewall software 59
 - fn key, identifying 13, 14, 33
 - fun things to do 1
- H**
 - hard drive
 - identifying 16
 - hard drive light 4
 - HDMI port
 - connecting 29
 - identifying 5, 25, 27
 - HDMI, configuring audio 30
 - headphone, connecting 28
 - Hibernation
 - exiting 39
 - initiated during critical battery level 43
 - initiating 39
 - high-definition devices,
 - connecting 29
 - hot keys
 - description 33
 - reveal system information 33
 - using 33
 - HP and third-party software
 - updates, installing 59
 - HP Recovery Manager 67
 - hubs 45
- I**
 - input power 70
 - installing
 - critical security updates 59
 - optional security cable lock 60
 - integrated numeric keypad,
 - identifying 14, 34
 - internal display switch,
 - identifying 7, 8

internal microphone, identifying
7, 8, 24, 26
Internet connection setup 21
Internet security software, using
58

J

jacks
audio-in (microphone) 6, 25,
27
audio-out (headphone) 6, 25,
27
network 5
RJ-45 (network) 5

K

keyboard hot keys, identifying 33
keys
action 13, 14
esc 13, 14
fn 13, 14
num lk 14
Windows 13, 14

L

labels
Bluetooth 18
Microsoft Certificate of
Authenticity 18
regulatory 18
serial number 17
service 17
wireless certification 18
WLAN 18
latch
battery lock 15
battery release 15
lights
AC adapter 5
caps lock 10, 11
hard drive 4
mute 10, 11
power 4
webcam 24, 26
wireless 10, 11

M

maintenance
Disk Cleanup 49
Disk Defragmenter 48

memory card
inserting 47
removing 47
memory card reader, identifying
3
memory module
identifying 16
inserting 51
removing 50
replacing 49
microphone
connecting 28
identifying 7, 8, 24, 26
Microsoft Certificate of Authenticity
label 18
mouse, external
setting preferences 32
multimedia features 24
mute light, identifying 10, 11

N

network jack, identifying 5
num lk key, identifying 14
num lock key, identifying 34

O

operating environment 71
operating system
Microsoft Certificate of
Authenticity label 18
Product Key 18
optical drive eject button,
identifying 4
optical drive, identifying 4, 25, 26
optional external devices, using
46
original system recovery 67

P

passwords
Setup Utility (BIOS) 58
Windows 57
pinching TouchPad gesture 37
ports
external monitor 5, 25, 27, 29
HDMI 5, 25, 27, 29
USB 25, 26
USB 2.0 4
USB 3.0 6, 25, 27
VGA 29

power
battery 40
conserving 42
power button, identifying 12
power connector, identifying 5
power lights, identifying 4
power meter 39
PowerDVD 31
Product Key 18
product name and number,
computer 17
public WLAN connection 22

R

readable media 38
recovering from the recovery
discs 68
recovering the original system 67
recovery 67
HP Recovery Manager 67
recovery discs 64
recovery media 64
recovery, system 67
regulatory information
regulatory label 18
wireless certification labels 18
restore points 65
restoring the original system
creating recovery media 64
RJ-45 (network) jack, identifying
5

S

scrolling TouchPad gesture 37
security cable lock, installing 60
security cable slot, identifying 5
security, wireless 21
serial number 17
service labels, locating 17
setting password protection on
wakeup 39
setup of WLAN 21
Setup Utility (BIOS) passwords
58
shipping the computer 54
shutdown 44
Sleep
exiting 38
initiating 38

- slots
 - memory card 3
 - security cable 5
 - software
 - CyberLink PowerDVD 31
 - Disk Cleanup 49
 - Disk Defragmenter 48
 - software updates, installing 59
 - speaker openings, identifying 16
 - speakers
 - connecting 28
 - speakers, identifying 25, 26
 - storing a battery 43
 - supported discs 64
 - system information hot key 33
 - system recovery 67
 - system restore points, creating 65
- T**
- temperature 43
 - TouchPad
 - buttons 9, 34
 - using 34
 - TouchPad gestures
 - pinching 37
 - scrolling 37
 - zooming 37
 - TouchPad zone, identifying 9, 34
 - traveling with the computer 18, 43, 54
 - troubleshooting
 - AC adapter 75
 - audio functions 74
 - low battery level 75
 - power management 75
 - wireless connection 72
 - Troubleshooting and support 72
 - turning off the computer 44
- U**
- unresponsive system 44
 - USB 2.0 ports, identifying 4, 25, 26
 - USB 3.0 port, identifying 6, 25, 27
 - USB cable, connecting 46
 - USB devices
 - connecting 45
 - description 45
 - removing 46
 - USB hubs 45
 - using external AC power 43
 - using passwords 57
 - using the power meter 39
- V**
- vent, identifying 5
 - vents, identifying 15
 - VGA port, connecting 29
 - video 28
- W**
- webcam
 - identifying 7, 8, 24, 26
 - using 27
 - webcam light, identifying 7, 8, 24, 26
 - Windows Backup and Restore
 - restoring files 67
 - Windows key, identifying 13, 14
 - Windows passwords 57
 - Windows security updates, installing 59
 - Wireless Assistant software 19
 - wireless button 19
 - wireless certification label 18
 - wireless controls
 - button 19
 - operating system 19
 - Wireless Assistant software 19
 - wireless light 10, 11, 19
 - wireless network (WLAN)
 - connecting 22
 - corporate WLAN connection 22
 - equipment needed 21
 - functional range 22
 - public WLAN connection 22
 - security 21
 - using 20
 - wireless network, securing 59
 - WLAN antennas, identifying 7, 8
 - WLAN device 18, 20
 - WLAN label 18
 - writable media 38
 - WWAN antennas, identifying 7, 8
- Z**
- zooming TouchPad gesture 37