



# Hardware Installation Guide

Product Model: DGS-1510 Series

Gigabit Ethernet SmartPro Switch

Release 1.10

Information in this document is subject to change without notice. Reproduction in any manner whatsoever, without the written permission of D-Link Corporation, is strictly forbidden.

Trademarks used in this text: D-Link and the D-LINK logo are trademarks of D-Link Corporation; Microsoft and Windows are registered trademarks of Microsoft Corporation.

Other trademarks and trade names may be used in this document to refer to either the entities claiming the marks and names or their products. D-Link Corporation disclaims any proprietary interest in trademarks and trade names other than its own.

© 2014 D-Link Corporation. All rights reserved.

April, 2014 P/N 651GS1510015G

### **FCC Warning**

This equipment has been tested and found to comply with the limits for a Class A digital device, pursuant to Part 15 of the FCC Rules. These limits are designed to provide reasonable protection against harmful interference when the equipment is operated in a commercial environment. This equipment generates, uses, and can radiate radio frequency energy and, if not installed and used in accordance with this manual, may cause harmful interference to radio communications. Operation of this equipment in a residential area is likely to cause harmful interference in which case the user will be required to correct the interference at his expense.

### **CE Mark Warning**

This is a Class A product. In a domestic environment, this product may cause radio interference in which case the user may be required to take adequate measures.

### **Warnung!**

Dies ist ein Produkt der Klasse A. Im Wohnbereich kann dieses Produkt Funkstörungen verursachen. In diesem Fall kann vom Benutzer verlangt werden, angemessene Massnahmen zu ergreifen.

### **Precaución!**

Este es un producto de Clase A. En un entorno doméstico, puede causar interferencias de radio, en cuyo caso, puede requerirse al usuario para que adopte las medidas adecuadas.

### **Attention!**

Ceci est un produit de classe A. Dans un environnement domestique, ce produit pourrait causer des interférences radio, auquel cas l'utilisateur devrait prendre les mesures adéquates.

### **Attenzione!**

Il presente prodotto appartiene alla classe A. Se utilizzato in ambiente domestico il prodotto può causare interferenze radio, nel cui caso è possibile che l'utente debba assumere provvedimenti adeguati.

### **VCCI Warning**

この装置は、クラス A 情報技術装置です。この装置を家庭環境で使用すると電波妨害を引き起こすことがあります。この場合には使用者が適切な対策を講ずるよう要求されることがあります。 VCCI-A

### **BSMI Notice**

此為甲類的資訊技術設備，在居住環境中使用時，可能會造成射頻擾動，在這種情況下，使用者會被要求採取某些適當的對策。

# Table of Contents

<b>Table of Contents</b> .....	<b>iii</b>
Intended Readers .....	v
Typographical Conventions .....	v
Notes, Notices, and Cautions .....	v
Safety Instructions .....	vi
Safety Precautions .....	vi
General Precautions for Rack-Mountable Products .....	vii
Protecting Against Electrostatic Discharge .....	viii
<b>1. Introduction</b> .....	<b>9</b>
Switch Description .....	9
Package Contents .....	9
Features .....	10
Front-Panel Components .....	11
Ports .....	12
LED Indicators .....	13
Rear Panel Components .....	15
Side Panel Components .....	16
Smart Fans .....	18
<b>2. Installation</b> .....	<b>19</b>
Installation Guidelines .....	19
Installing the Switch without a Rack .....	19
Attaching Brackets to a Switch for Rack Mounting .....	20
Installing the Switch in a Standard 19" Rack .....	20
Installing Transceivers into the Transceiver Ports .....	21
Power On (AC Power) .....	21
Power Failure (AC Power) .....	22
Installing Power Cord Clip .....	22
<b>3. Connecting the Switch</b> .....	<b>25</b>
Switch to End Node .....	25
Switch to another Switch .....	25
Connect to a Network Backbone or Server .....	26
<b>4. Introduction to Switch Management</b> .....	<b>27</b>
Management Options .....	27
Connecting the Console Port .....	27
Connecting to the Switch for the First Time .....	28
Creating a User Account .....	29
Configuring the IP Address .....	30
SNMP Settings .....	31
Traps .....	32
Management Information Base (MIB) .....	32
D-Link Network Assistant (DNA) .....	33
<b>5. Web-based Switch Configuration</b> .....	<b>34</b>
Introduction .....	34
Logging onto the Web Manager .....	34
Web-based User Interface .....	35

Areas of the User Interface.....	35
Web Pages .....	37
<b>Appendix A – Technical Specifications .....</b>	<b>38</b>
General .....	38
Physical and Environmental.....	39
Performance.....	40
LED Indicators .....	41
Port Functions.....	43
<b>Appendix B – Cables and Connectors .....</b>	<b>46</b>
Ethernet Cable .....	46
Console Cable .....	47
<b>Technical Support.....</b>	<b>488</b>

## Intended Readers

***Intended Readers***  
***Typographical Conventions***  
***Notes, Notices, and Cautions***  
***Safety Instructions***  
***General Precautions for Rack-Mountable Products***  
***Protecting Against Electrostatic Discharge***

The **DGS-1510 Series Hardware Installation Guide** contains information about the configuration and management of the switch. This manual is intended for network administrators familiar with network management concepts and terminology. For all practical reasons all the switches in this series will simply be referred to as the **Switch** throughout this manual. All example screenshots are taken from the **DGS-1510-28P** switch.

## Typographical Conventions

Convention	Description
[ ]	In a command line, square brackets indicate an optional entry. For example: [copy filename] means that optionally you can type copy followed by the name of the file. Do not type the brackets.
<b>Bold Font</b>	Indicates a button, a toolbar icon, menu, or menu item. For example: Open the <b>File</b> menu and choose <b>Cancel</b> . Used for emphasis. May also indicate system messages or prompts appearing on screen. For example: <b>You have mail</b> .
<i>Courier New Font</i>	Indicates commands and responses to prompts that must be typed exactly as printed in the manual.
Initial capital letter	Indicates a window name. Names of keys on the keyboard have initial capitals. For example: Click <b>Enter</b> .
<i>Italics</i>	Indicates a window name or a field. Also can indicate a variables or parameter that is replaced with an appropriate word or string. For example: type <i>filename</i> means that the actual filename should be typed instead of the word shown in italic.
<b>Menu Name &gt; Menu Option</b>	<b>Menu Name &gt; Menu Option</b> indicates the menu structure. <b>Device &gt; Port &gt; Port Properties</b> means the Port Properties menu option under the Port menu option that is located under the Device menu.

## Notes, Notices, and Cautions



**NOTE:** A note indicates important information that helps you make better use of your device.



**NOTICE:** A notice indicates either potential damage to hardware or loss of data and tells you how to avoid the problem.



**CAUTION:** A caution indicates a potential for property damage, personal injury, or death.

## Safety Instructions

Use the following safety guidelines to ensure your own personal safety and to help protect your system from potential damage. Throughout this safety section, the caution icon () is used to indicate precautions that need to be reviewed and followed.

## Safety Precautions

To reduce the risk of bodily injury, electrical shock, fire, and damage to the equipment observe the following precautions:

- Observe and follow service markings.
- Do not service any product except as explained in the system documentation.
- Opening or removing covers that are marked with the triangular symbol with a lightning bolt may expose the user to electrical shock.
  - Only a trained service technician should service components inside these compartments.
- If any of the following conditions occur, unplug the product from the electrical outlet and replace the part or contact your trained service provider:
  - Damage to the power cable, extension cable, or plug.
  - An object has fallen into the product.
  - The product has been exposed to water.
  - The product has been dropped or damaged.
  - The product does not operate correctly when the operating instructions are correctly followed.
- Keep your system away from radiators and heat sources. Also, do not block cooling vents.
- Do not spill food or liquids on system components, and never operate the product in a wet environment. If the system gets wet, see the appropriate section in the troubleshooting guide or contact your trained service provider.
- Do not push any objects into the openings of the system. Doing so can cause fire or electric shock by shorting out interior components.
- Use the product only with approved equipment.
- Allow the product to cool before removing covers or touching internal components.
- Operate the product only from the type of external power source indicated on the electrical ratings label. If unsure of the type of power source required, consult your service provider or local power company.
- To help avoid damaging the system, be sure the voltage selection switch (if provided) on the power supply is set to match the power available at the Switch's location:

- 115 volts (V)/60 hertz (Hz) in most of North and South America and some Far Eastern countries such as South Korea and Taiwan
- 100 V/50 Hz in eastern Japan and 100 V/60 Hz in western Japan
- 230 V/50 Hz in most of Europe, the Middle East, and the Far East
- Also, be sure that attached devices are electrically rated to operate with the power available in your location.
- Use only approved power cable(s). If you have not been provided with a power cable for your system or for any AC-powered option intended for your system, purchase a power cable that is approved for use in your country. The power cable must be rated for the product and for the voltage and current marked on the product's electrical ratings label. The voltage and current rating of the cable should be greater than the ratings marked on the product.
- To help prevent electric shock, plug the system and peripheral power cables into properly grounded electrical outlets. These cables are equipped with three-prong plugs to help ensure proper grounding. Do not use adapter plugs or remove the grounding prong from a cable. If using an extension cable is necessary, use a 3-wire cable with properly grounded plugs.
- Observe extension cable and power strip ratings. Make sure that the total ampere rating of all products plugged into the extension cable or power strip does not exceed 80 percent of the ampere ratings limit for the extension cable or power strip.
- To help protect the system from sudden, transient increases and decreases in electrical power, use a surge suppressor, line conditioner, or uninterruptible power supply (UPS).
- Position system cables and power cables carefully; route cables so that they cannot be stepped on or tripped over. Be sure that nothing rests on any cables.
- Do not modify power cables or plugs. Consult a licensed electrician or your power company for site modifications. Always follow your local/national wiring rules.
- When connecting or disconnecting power to hot-pluggable power supplies, if offered with your system, observe the following guidelines:
  - Install the power supply before connecting the power cable to the power supply.
  - Unplug the power cable before removing the power supply.
  - If the system has multiple sources of power, disconnect power from the system by unplugging all power cables from the power supplies.
- Move products with care; ensure that all casters and/or stabilizers are firmly connected to the system. Avoid sudden stops and uneven surfaces.

## General Precautions for Rack-Mountable Products

Observe the following precautions for rack stability and safety. Also, refer to the rack installation documentation accompanying the system and the rack for specific caution statements and procedures.

- Systems are considered to be components in a rack. Thus, "component" refers to any system as well as to various peripherals or supporting hardware.



**CAUTION:** Installing systems in a rack without the front and side stabilizers installed could cause the rack to tip over, potentially resulting in bodily injury under certain circumstances. Therefore, always install the stabilizers before installing components in the rack. After installing system/components in a rack, never pull more than one component out of the rack on its slide assemblies at one time. The weight of more than one extended component could cause the rack to tip over and may result in serious injury.

- Before working on the rack, make sure that the stabilizers are secured to the rack, extended to the floor, and that the full weight of the rack rests on the floor. Install front and side stabilizers on a single rack or front stabilizers for joined multiple racks before working on the rack.
- Always load the rack from the bottom up, and load the heaviest item in the rack first.
- Make sure that the rack is level and stable before extending a component from the rack.
- Use caution when pressing the component rail release latches and sliding a component into or out of a rack; the slide rails can pinch your fingers.
- After a component is inserted into the rack, carefully extend the rail into a locking position, and then slide the component into the rack.
- Do not overload the AC supply branch circuit that provides power to the rack. The total rack load should not exceed 80 percent of the branch circuit rating.
- Ensure that proper airflow is provided to components in the rack.
- Do not step on or stand on any component when servicing other components in a rack.



**NOTE:** A qualified electrician must perform all connections to DC power and to safety grounds. All electrical wiring must comply with applicable local or national codes and practices.



**CAUTION:** Never defeat the ground conductor or operate the equipment in the absence of a suitably installed ground conductor. Contact the appropriate electrical inspection authority or an electrician if uncertain that suitable grounding is available.



**CAUTION:** The system chassis must be positively grounded to the rack cabinet frame. Do not attempt to connect power to the system until grounding cables are connected. Completed power and safety ground wiring must be inspected by a qualified electrical inspector. An energy hazard will exist if the safety ground cable is omitted or disconnected.

## Protecting Against Electrostatic Discharge

Static electricity can harm delicate components inside the system. To prevent static damage, discharge static electricity from your body before touching any of the electronic components, such as the microprocessor. This can be done by periodically touching an unpainted metal surface on the chassis.

The following steps can also be taken prevent damage from electrostatic discharge (ESD):

1. When unpacking a static-sensitive component from its shipping carton, do not remove the component from the antistatic packing material until ready to install the component in the system. Just before unwrapping the antistatic packaging, be sure to discharge static electricity from your body.
2. When transporting a sensitive component, first place it in an antistatic container or packaging.
3. Handle all sensitive components in a static-safe area. If possible, use antistatic floor pads, workbench pads and an antistatic grounding strap.



# 1. Introduction

**Switch Description**

**Package Contents**

**Features**

**Front-Panel Components**

**Rear Panel Components**

**Side Panel Components**

This **Hardware Installation Guide** is a detailed document explaining information about the hardware installation, configuration, specifications, guidelines, and maintenance of a D-Link switch.

## Switch Description

The **DGS-1510 Series** is D-Link's next generation SmartPro Switch. It features built-in 10Gbps SFP+ ports targeted for SME/SMB core deployment to improve connectivity between core switches and edge switches. The DGS-1510 Series also implements D-Link's innovative 3<sup>rd</sup> generation Green Ethernet technology (IEEE 802.3az) by not only saving power over inactive links, but also turning off LEDs on a customized schedule and allowing ports to enter a hibernative state automatically.

In the **DGS-1510 Series**, the following switches are available: **DGS-1510-20**, **DGS-1510-28**, **DGS-1510-28P**, **DGS-1510-28X**, **DGS-1510-52**, and **DGS-1510-52X**. Some features, throughout this guide, will apply to all the switches within the **DGS-1510 Series**. When referring to these universal features, we'll simply refer to the product as the **Switch**.

## Package Contents

When purchasing a D-Link DGS-1510 Series Switch, a list of items will be included in the package of the Switch. Open the shipping carton of the Switch and carefully unpack its contents. The carton should contain the following items:

- One D-Link DGS-1510 Series Switch.
- One Quick Installation Guide.
- One AC power cord.
- One console cable.
- One power cord cable clip.
- One mounting mit (two brackets and screws).
- Four rubber feet with adhesive backing.
- One CD that includes a digital copy of the CLI Reference Guide, Web UI Reference Guide, Hardware Installation Guide, D-View module, D-Link Network Assistant, and D-Link Network Assistant Guide.



**NOTE:** If any item is missing or damaged, please contact your local D-Link Reseller for replacement.

# Features

The list of features below highlights the significant features of the Switch.

- Supports Virtual Stacking. D-Link Single IP Management (SIM).
- Supports Physical Stacking, using the SFP+ ports with 40G (Full Duplex) in topologies Linear and Ring.
- Supports a 16K MAC address table.
- Supports Flow Control (802.3x) in full-duplex compliant.
- Supports Jumbo Frames of up to 9Kbytes
- Supports Spanning Tree with 802.1D 2004 STP/RSTP and 802.1Q 2005 MSTP.
- Supports Loopback Detection (LBD).
- Supports Link Aggregation (802.3ad and 802.3AX) with a maximum of 32 groups per Switch.
- Supports Port Mirroring.
- Supports Layer 2 Multicast Filtering.
- Supports IGMP Snooping (v1, v2, v3 awareness) with up to 512 snooping groups and 128 static multicast addresses. MLD Snooping (v1, v2 awareness) with up to 512 snooping groups and 128 static multicast addresses. IGMP Snooping and MLD Snooping share 128 static groups and 512 snooping groups.
- Supports Virtual LAN (802.1Q) with up to 4K static VLAN groups and 4K dynamic VLAN groups.
- Supports Port-based VLAN.
- Supports Asymmetric VLAN.
- Supports Auto Voice and Surveillance VLAN.
- Supports IP Interfaces with up to 8 IP interfaces.
- Supports Gratuitous ARP.
- Supports IPv6 Ready Phase 2 compliancy.
- Supports Static Routing.
- Supports Quality of Service (QoS) with Queue Handling and Class of Service (CoS).
- Supports Access Control List (ACL) with Ingress ACL, Time-based ACL, and ACL Statistics.
- Supports Secure Shell (SSHv2) with IPv4/IPv6 access.
- Supports Secure Sockets Layer (SSL) versions 1, 2, and 3 with IPv4/IPv6 access.
- Supports Port Security of up to 128 MAC addresses.
- Supports Broadcast and Multicast Storm Control.
- Supports Traffic Segmentation
- Supports D-Link SafeGuard Engine.
- Supports ARP Spoofing Prevention.
- Supports IP-MAC-Port Binding (IMPB). This feature includes DHCP Snooping, IP Source Guard, Dynamic ARP Inspection, DHCPv6 Guard, RA Guard, IPv6 Snooping, IPv6 Source Guard, and IPv6 ND Snooping.
- Supports DoS Attack Prevention.

- Supports Port-based Network Access Control (PNAC) better known as 802.1X. This feature includes Local and RADIUS databasis, Port-based Access Control, and MAC-based Access Control (MAC).
- Supports Web-based Access Control (WAC).
- Supports Japanese Web-based Access Control (JWAC).
- Supports Guest VLAN.
- Supports 15 User Account Privilege Levels.
- Supports Compound Authentication.
- Supports Link Layer Discovery Protocol (LLDP) with LLDP-MED.
- Supports Accessibility using multiple interfaces like the Command Line Interface (CLI), Web-based Graphical User Interface (Web-based GUI), and more.
- Supports Telnet Server and Client from IPv4 and IPv6.
- Supports Trivial File Transfer Protocol (TFTP) Client.
- Supports Simple Network Management Protocol (SNMP) version 1, 2c, and 3. Also supports SNMP Traps.
- Supports DHCP Client.
- Supports Dynamic Host Configuration Protocol (DHCP) Relay.
- Supports Traps and Logs.
- Support Multiple Images.
- Supports Password Encryption.
- Supports Simple Network Time Protocol (SNTP).
- Support Power Saving using the Link Status Mode.
- Support Time-based Power-over-Ethernet (PoE).
- Supports IEEE 802.3az compliance.
- Supports Optical Transceiver Digital Diagnostic Monitoring (DDM).
- Supports D-Link Discovery Protocol (DDP).
- Supports MIBs like MIBII, Bridge MIB, SNMPv2 MIB, RMON MIB, RMONv2 MIB, Ether-like MIB, 802.3 MAU MIB, 802.1p MIB, RADIUS Authentication Client MIB, Ping MIB, L2 Specific MIB, Private MIB, Entity MIB, and ZoneDefense MIB.

## Front-Panel Components

The Front Panel of the Switch features a variety of **Ports** and **LED Indicators** that will be discussed in detail in this section. Also located on the front panel of the Switch is a **Reset** button, that can be pressed and held for **5 seconds** to perform a factory reset on the Switch after which the Switch will reboot. This will clear all the software modifications done on the Switch to their factory default settings.

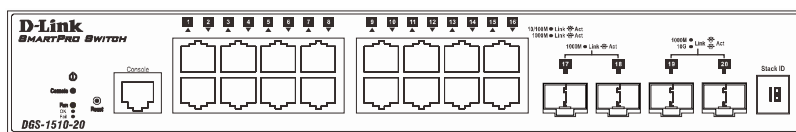

Figure 1–1 Front panel view of a DGS-1510-20 Switch

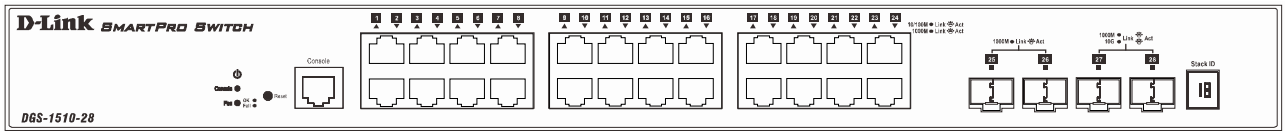

Figure 1-2 Front panel view of a DGS-1510-28 Switch

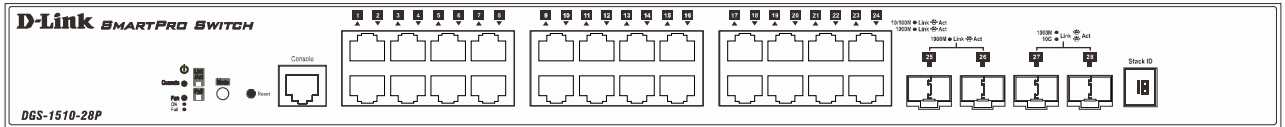

Figure 1-3 Front panel view of a DGS-1510-28P Switch

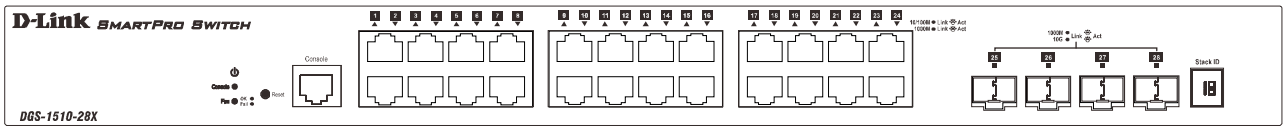

Figure 1-4 Front panel view of a DGS-1510-28X Switch

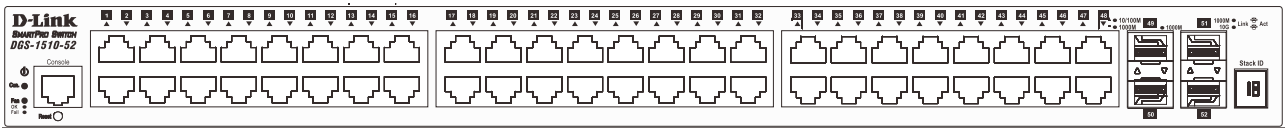

Figure 1-5 Front panel view of a DGS-1510-52 Switch

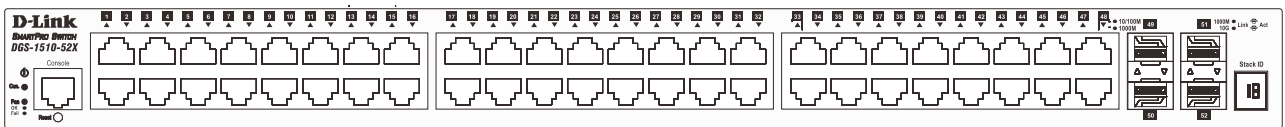

Figure 1-6 Front panel view of a DGS-1510-52X Switch

## Ports

The Type and Number of ports available on the Switch are listed out below:

- **DGS-1510-20:**
  - Sixteen Copper Ports (10BASE-T/100BASE-TX/1000BASE-T),
  - Two SFP Ports (1000BASE),
  - Two Dual Speed SFP+ Ports (1000BASE/10GBASE),
  - One Console Port (RJ-45),
- **DGS-1510-28:**
  - Twenty-four Copper Ports (10BASE-T/100BASE-TX/1000BASE-T),
  - Two SFP Ports (1000BASE),
  - Two Dual Speed SFP+ Ports (1000BASE/10GBASE),
  - One Console Port (RJ-45),
- **DGS-1510-28P:**
  - Twenty-four Copper PoE Ports (10BASE-T/100BASE-TX/1000BASE-T),

- Two SFP Ports (1000BASE),
- Two Dual Speed SFP+ Ports (1000BASE/10GBASE),
- One Console Port (RJ-45),
- **DGS-1510-28X:**
  - Twenty-four Copper Ports (10BASE-T/100BASE-TX/1000BASE-T),
  - Four SFP/SFP+ Ports (1000BASE/10GBASE),
  - One Console Port (RJ-45),
- **DGS-1510-52:**
  - Forty-eight Copper Ports (10BASE-T/100BASE-TX/1000BASE-T),
  - Two SFP Ports (1000BASE),
  - Two Dual Speed SFP+ Ports (1000BASE/10GBASE),
  - One Console Port (RJ-45),
- **DGS-1510-52X:**
  - Forty-eight Copper Ports (10BASE-T/100BASE-TX/1000BASE-T),
  - Four SFP/SFP+ Ports (1000BASE/10GBASE),
  - One Console Port (RJ-45),

## LED Indicators

The Switch's front panel presents LED indicators for Power, Console, Master (Stack Control), Stack ID and Link/Act indicators for all the ports. The **DGS-1510-28P** switches are equipped with an additional PoE light, to indicate whether the ports are running in Power over Ethernet mode.

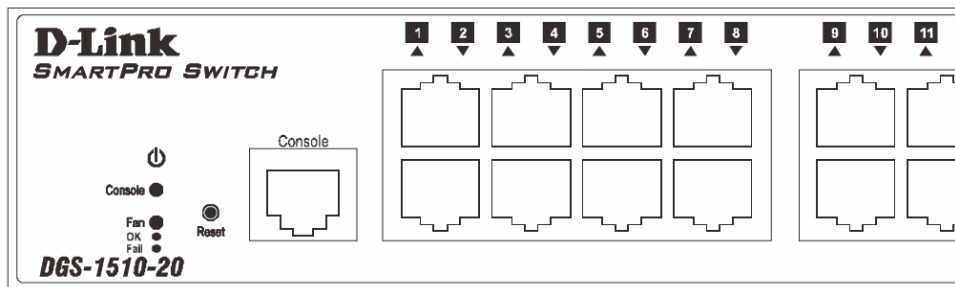

Figure 1-7 LED indicators for a DGS-1510-20 Switch

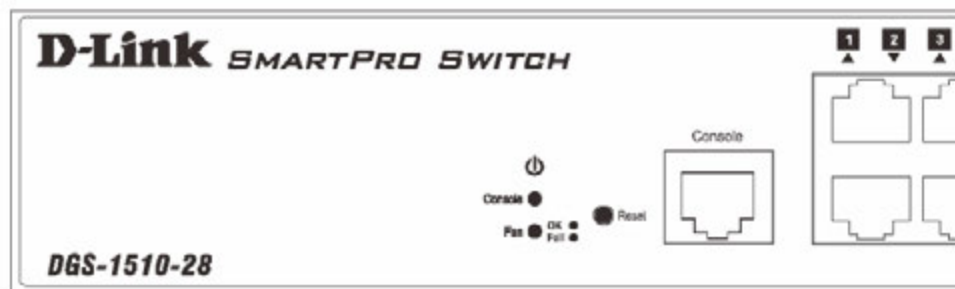

Figure 1-8 LED indicators for a DGS-1510-28 Switch



Figure 1–9 LED indicators for a DGS-1510-28P Switch

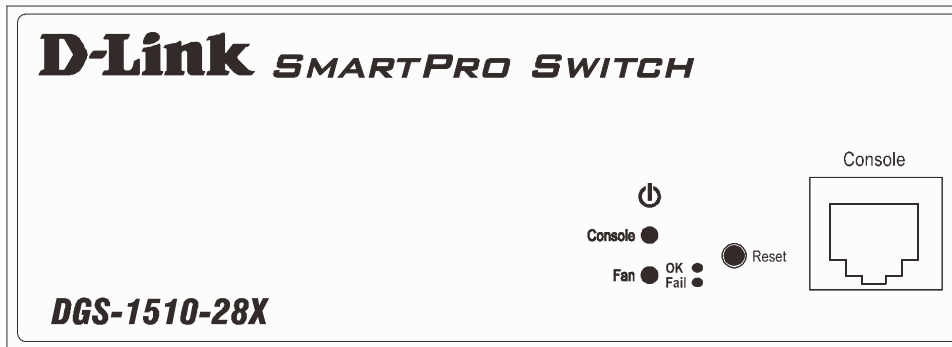

Figure 1–10 LED indicators for a DGS-1510-28X Switch

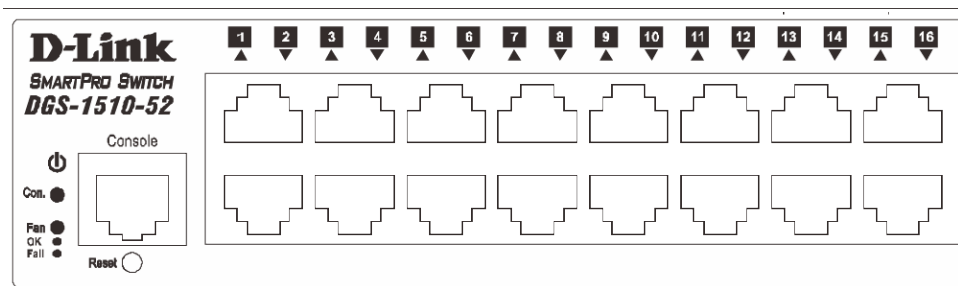

Figure 1–11 LED indicators for a DGS-1510-52 Switch

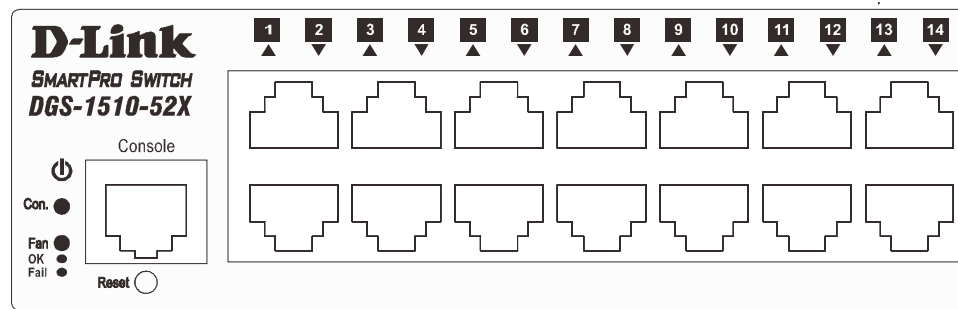



Figure 1–12 LED indicators for a DGS-1510-52X Switch

A separate table below describes LED indicators in more detail.

LED	Description
-----	-------------

<b>Power</b> 	This LED will light green after powering the Switch on to indicate the ready state of the device. The indicator is dark when the Switch is no longer receiving power (i.e. powered off).
<b>Console</b>	This LED will blink green during the Power-On Self Test (POST). When the POST is finished, the LED goes dark. The indicator will light steady green when a user is logged in through the console port.
<b>Fan</b>	This LED will light green after the diagnostics have passed with no errors. This LED blinks red when any of the fans has failed.
<b>Link/Act LEDs</b>	<p>The Switch has LED indicators for Link and Activity.</p> <p><b>Copper Ports:</b> The LED will light steady green when there is a secure connection (or link) to a 1000Mbps Ethernet device or steady orange when there is a secure connection (or link) to a 10/100Mbps Ethernet device at any of the copper ports. The LED will blink green when a 1000Mbps port is active or blink orange when a 10/100Mbps port is active. The LED remains dark when there is no link or activity.</p> <p><b>SFP Ports:</b> The LED will light steady green when there is a secure connection (or link) to a 1000Mbps Ethernet device at any of the SFP ports. The LED remains dark when there is no link or activity.</p> <p><b>SFP+ Ports:</b> The LED will light steady green when there is a secure connection (or link) to a 10Gbps Ethernet device or steady orange when there is a secure connection (or link) to a 1Gbps Ethernet device at any of the SFP+ ports. The LED will blink green when a 10Gbps port is active or blink orange when a 1Gbps port is active. The LED remains dark when there is no link or activity.</p>
<b>PoE</b>	Only the <b>DGS-1510-28P</b> switches are equipped with a PoE LED. When this light is on with a solid green light, it means that the corresponding ports are feeding power to the PoE devices plugged in. When this light is on with a solid orange light, it means that the port is in an error condition state. When this light is off, it means that the ports are not supplying power to the devices plugged into the ports.
<b>Stack ID</b>	For standalone Switches, this will display number "1". For stacked Switches, this indicates the position in the stacking box ID. The box ID is assigned either by the user (static mode) or by the system (automatic mode). When "1" to "6" is displayed, this indicates the stacking position of the switch. An "H" indicates the device was assigned as the stacking Master. "h" means the device was selected to be the Backup Master. A "G" is displayed when the Safeguard Engine feature enters the exhausted mode. An "E" is displayed when an error was found during the system self-test.

For more information about LED Indicators, refer to [LED Indicators](#).

## Rear Panel Components

The rear panel contains an AC power socket and a security lock.

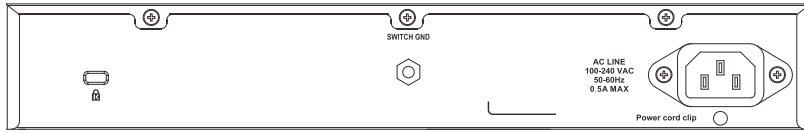

Figure 1-13 Rear panel view of a DGS-1510-20 Switch

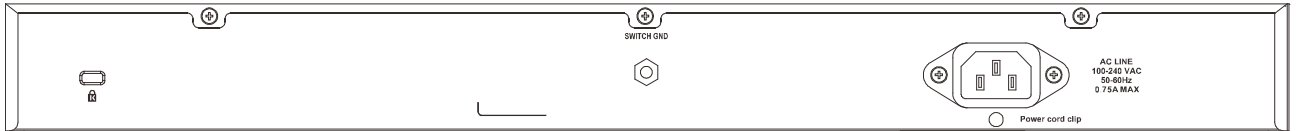

Figure 1-14 Rear panel view of a DGS-1510-28 Switch

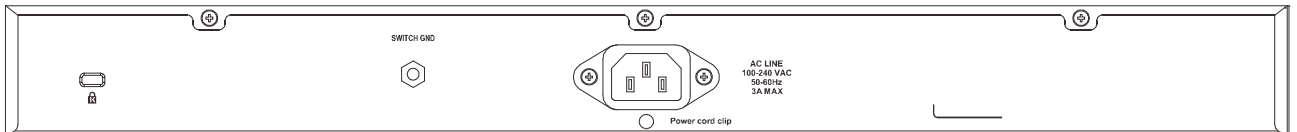

Figure 1-15 Rear panel view of a DGS-1510-28P Switch

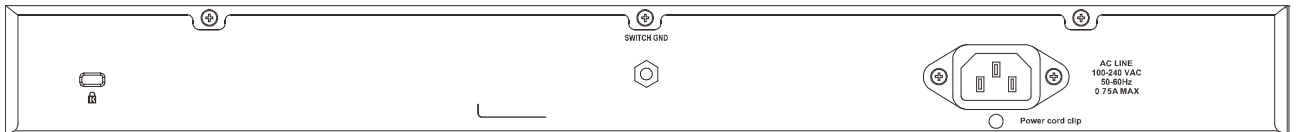

Figure 1-16 Rear panel view of a DGS-1510-28X Switch

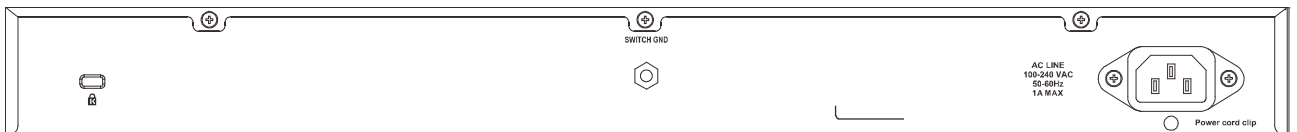

Figure 1-17 Rear panel view of a DGS-1510-52 Switch

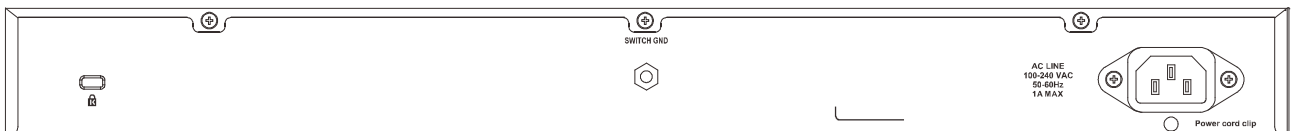

Figure 1-18 Rear panel view of a DGS-1510-52X Switch

The AC power connector is a standard three-pronged connector that supports the power cord. Plug-in the female connector of the provided power cord into this socket, and the male side of the cord into a power outlet. The Switch automatically adjusts the power setting to any supply voltage in the range from 100~240 VAC at 50~60 Hz.

## Side Panel Components

The system heat vents located on the sides of the Switch dissipate heat. Do not block these openings. Leave at least 6 inches of space at the rear and sides of the Switch for proper ventilation. Without proper heat dissipation and air circulation, system components might overheat which could lead to system failure or even severely damaged components.



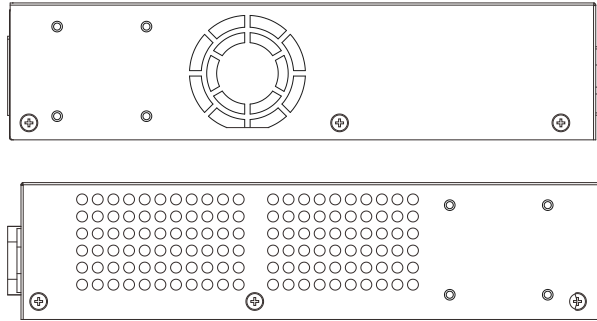

Figure 1-19 Side panels view of a DGS-1510-20 Switch

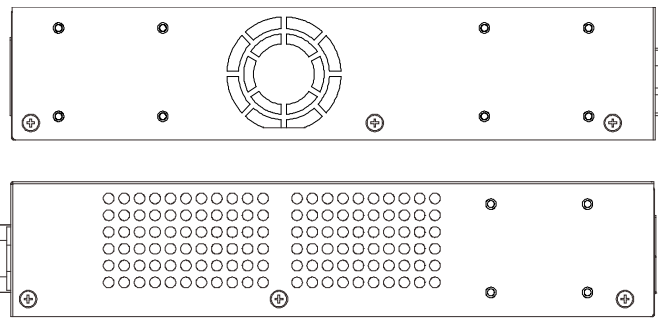

Figure 1-20 Side panels view of a DGS-1510-28 Switch

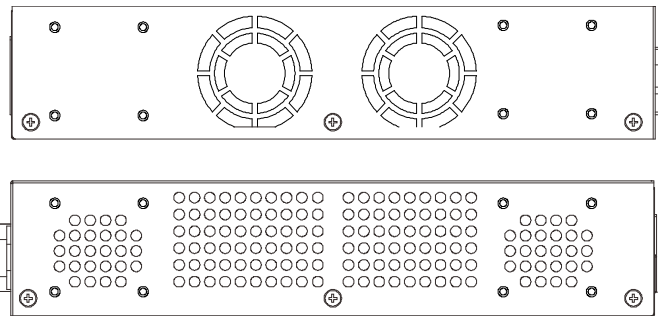

Figure 1-21 Side panels view of a DGS-1510-28P Switch

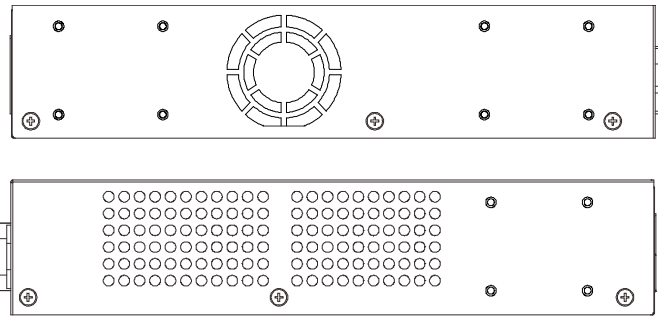

Figure 1-22 Side panels view of a DGS-1510-28X Switch

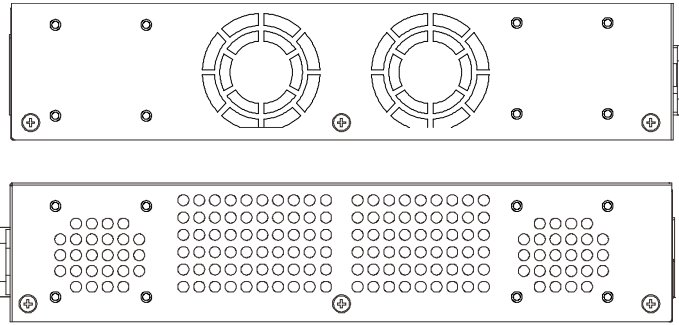

Figure 1-23 Side panels view of a DGS-1510-52 Switch

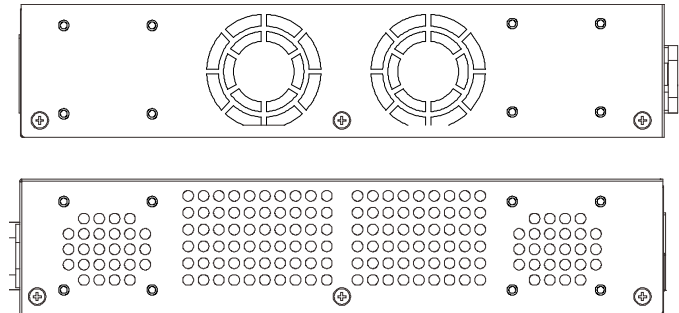

Figure 1-24 Side panels view of a DGS-1510-52X Switch

## Smart Fans

The DGS-1510 Series Switches includes **smart fans** that will automatically change their speed depending on the internal temperature detected by the sensors built-in the Switch's hardware. These smart fans support three states. They can either be **off**, running at a **low speed**, or running at a **high speed**.

The following will explain when these fans will toggle between low and high speeds:

- **DGS-1510-20:** When the internal temperature, detected by the sensor, **rises above 47°C**, the fan will automatically change to the **high speed**. When the internal temperature, detected by the sensor, **falls below 43°C**, the fan will automatically change to the **low speed**.
- **DGS-1510-28:** When the internal temperature, detected by the sensor, **rises above 48°C**, the fan will automatically change to the **high speed**. When the internal temperature, detected by the sensor, **falls below 43°C**, the fan will automatically change to the **low speed**.
- **DGS-1510-28P:** When the internal temperature, detected by the sensor, **rises above 42°C**, the fan will automatically change to the **high speed**. When the internal temperature, detected by the sensor, **falls below 39°C**, the fan will automatically change to the **low speed**.
- **DGS-1510-28X:** When the internal temperature, detected by the sensor, **rises above 48°C**, the fan will automatically change to the **high speed**. When the internal temperature, detected by the sensor, **falls below 43°C**, the fan will automatically change to the **low speed**.
- **DGS-1510-52:** When the internal temperature, detected by the sensor, **rises above 47°C**, the fan will automatically change to the **high speed**. When the internal temperature, detected by the sensor, **falls below 43°C**, the fan will automatically change to the **low speed**.
- **DGS-1510-52X:** When the internal temperature, detected by the sensor, **rises above 45°C**, the fan will automatically change to the **high speed**. When the internal temperature, detected by the sensor, **falls below 40°C**, the fan will automatically change to the **low speed**.

## 2. Installation

### **Installation Guidelines** **Power On (AC Power)**

## Installation Guidelines

Please follow these guidelines for setting up the Switch:

- Install the Switch on a sturdy, level surface that can support at least 3kg (6.6lb). Do not place heavy objects on the Switch.
- The power outlet should be within 1.82 meters (6 feet) of the Switch.
- Visually inspect the power cord and see that it is fully secured to the AC power port.
- Make sure that there is proper heat dissipation from and adequate ventilation around the Switch. Leave at least 10 cm (4 inches) of space at the front and rear of the Switch for ventilation.
- Install the Switch in a fairly cool and dry place for the acceptable temperature and humidity operating ranges.
- Install the Switch in a site free from strong electromagnetic field generators (such as motors), vibration, dust, and direct exposure to sunlight.
- When installing the Switch on a level surface, attach the rubber feet to the bottom of the device. The rubber feet cushion the Switch, protect the casing from scratches and prevent it from scratching other surfaces.

## Installing the Switch without a Rack

First, attach the rubber feet included with the Switch if installing on a desktop or shelf. Attach these cushioning feet on the bottom at each corner of the device. Allow enough ventilation space between the Switch and any other objects in the vicinity.

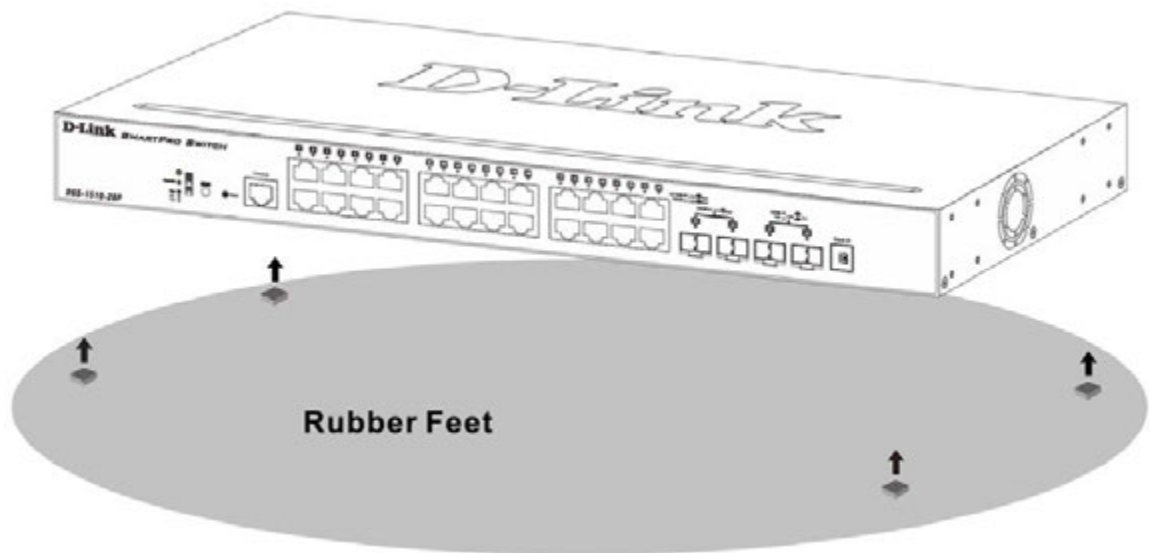

Figure 2-1 Attach rubber feet to the Switch.

## Attaching Brackets to a Switch for Rack Mounting

The Switch is mounted to a standard 19" rack using mounting brackets. Use the following diagrams as a guide.

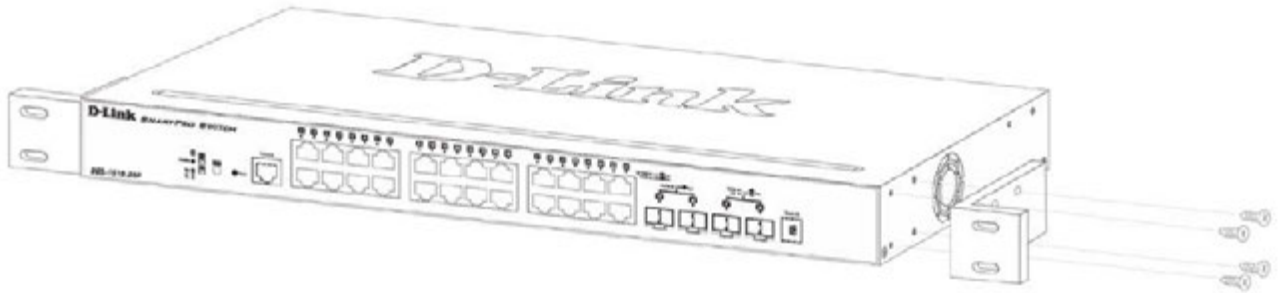

Figure 2–2 Attach mounting brackets to the Switch

Fasten the mounting brackets to the Switch using the screws provided. With the brackets attached securely, the Switch can be mounted in a standard rack, as shown below.



**NOTE:** Please review the Installation Guidelines above before installing the Switch in a rack. Make sure there is adequate space around the Switch to allow for proper air flow, ventilation and cooling.

## Installing the Switch in a Standard 19" Rack

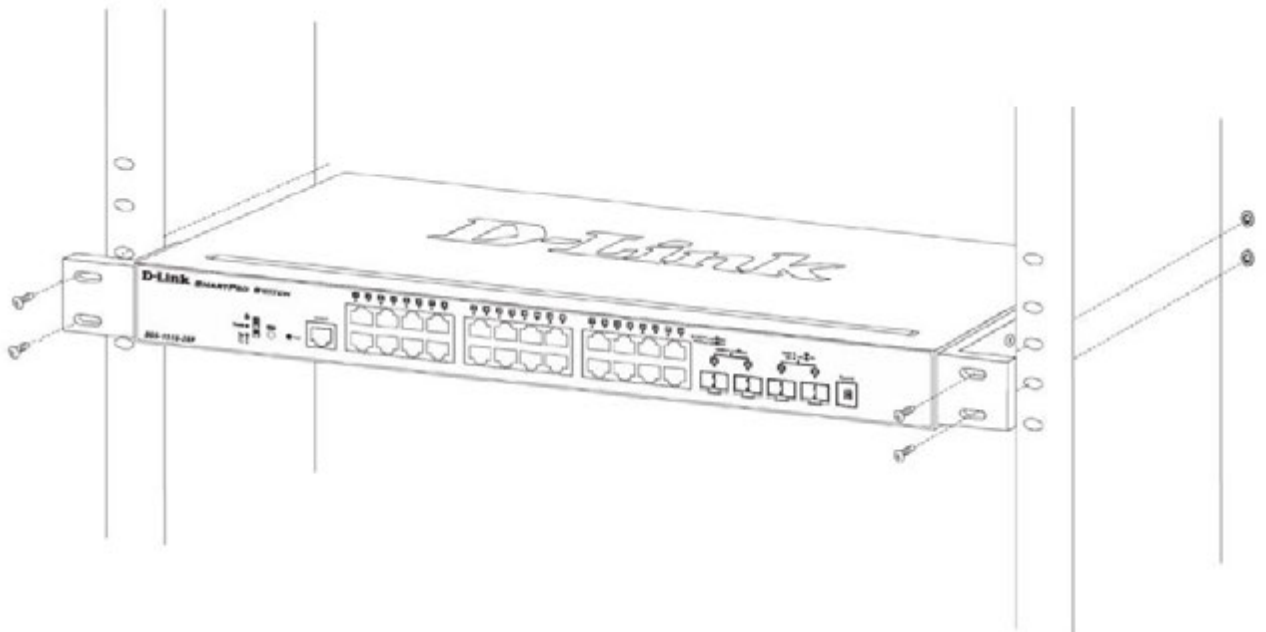

Figure 2–3 Mount the Switch in a rack



**CAUTION:** Installing systems in a rack without the front and side stabilizers installed could cause the rack to tip over, potentially resulting in bodily injury under certain circumstances. Therefore, always install the stabilizers before installing components in the rack. After installing components in a rack, do not pull more than one component out of the rack on its slide assemblies at one time. The weight of more than one extended component could cause the rack to tip over and may result in injury.

## Installing Transceivers into the Transceiver Ports

The Switch is equipped with SFP (Small Form Factor Portable) and SFP+ ports, which are used with fiber-optical transceiver cabling. SFP ports support full-duplex transmissions, auto-negotiation, and can be uplinked with various other switches across a gigabit network. The SFP ports support data rates of up to 1Gbit/s and the SFP+ ports support data rates of up to 10Gbit/s.

See the figure below for installing the transceiver in the transceiver port on the Switch.

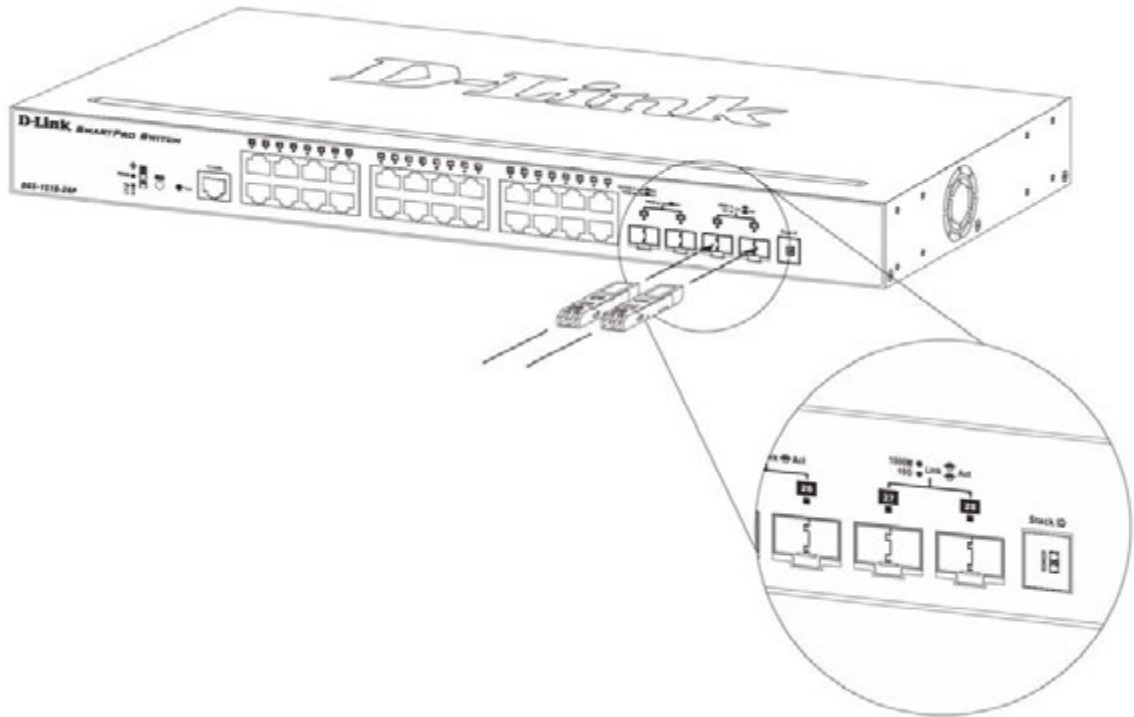

Figure 2-4 Inserting fiber-optic transceivers into a Switch

For a full list of supported transceivers, compatible with this switch series, refer to [Port Functions](#).

## Power On (AC Power)

Plug one end of the AC power cord into the power socket of the Switch and the other end into the local power source outlet. After the system powered on, the LED's blink green to indicate that the system is booting up.

## Power Failure (AC Power)

In the event of a power failure, just as a precaution, unplug the power cord from the Switch. After the power returns, plug the power cord back into the power socket of the Switch.

## Installing Power Cord Clip

To prevent accidental removal of the AC power cord, it is recommended to install the power cord clip together with the power cord.

1. With the rough side facing down, insert the Tie Wrap into the hole below the power socket.

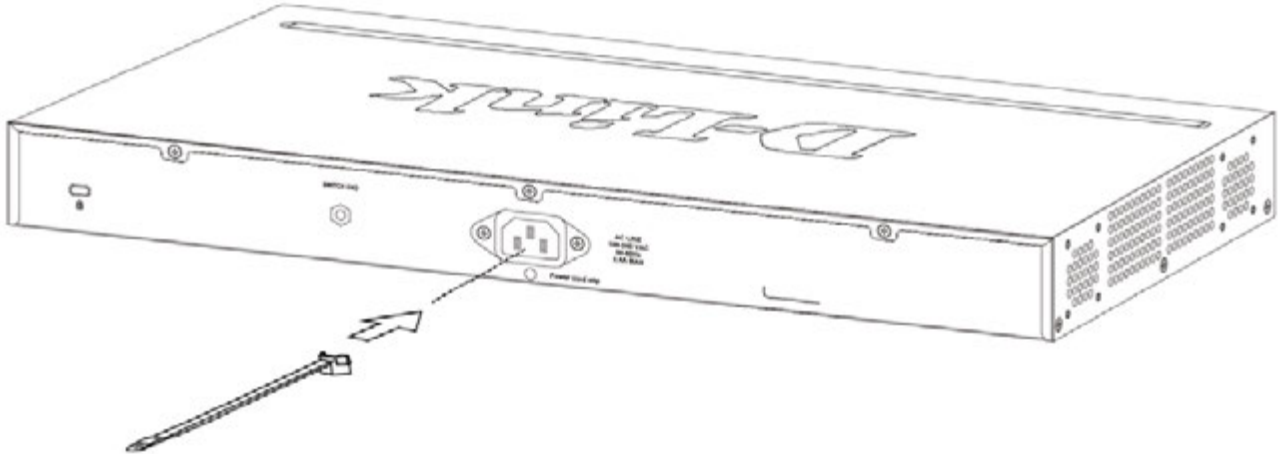

Figure 2-5 Insert Tie Wrap to the Switch

2. Plug the AC power cord into the power socket of the Switch.

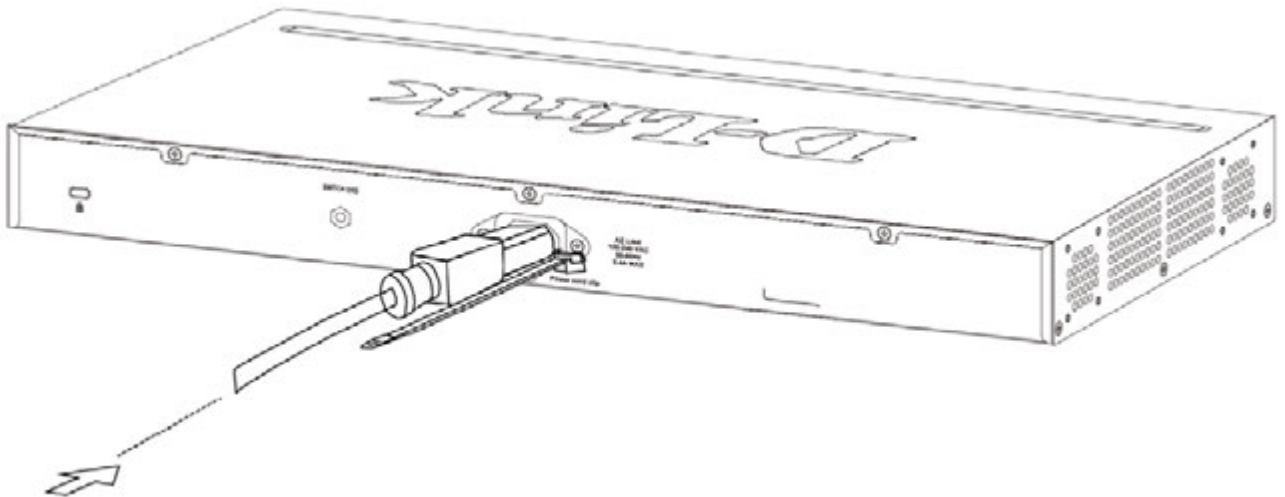

Figure 2-6 Connect the power cord to the Switch

3. Slide the Retainer through the Tie Wrap until the end of the cord.

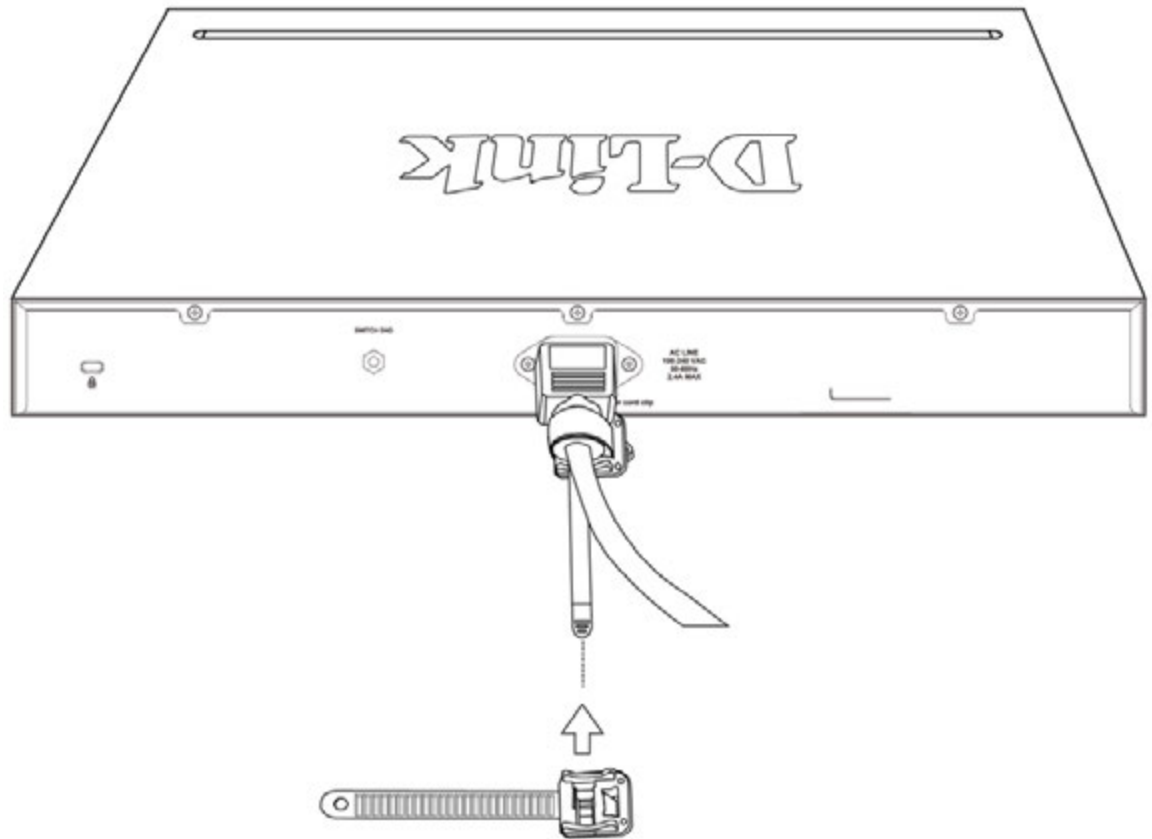

Figure 2-7 Slide the Retainer through the Tie Wrap

4. Circle the tie of the Retainer around the power cord and into the locker of the Retainer.

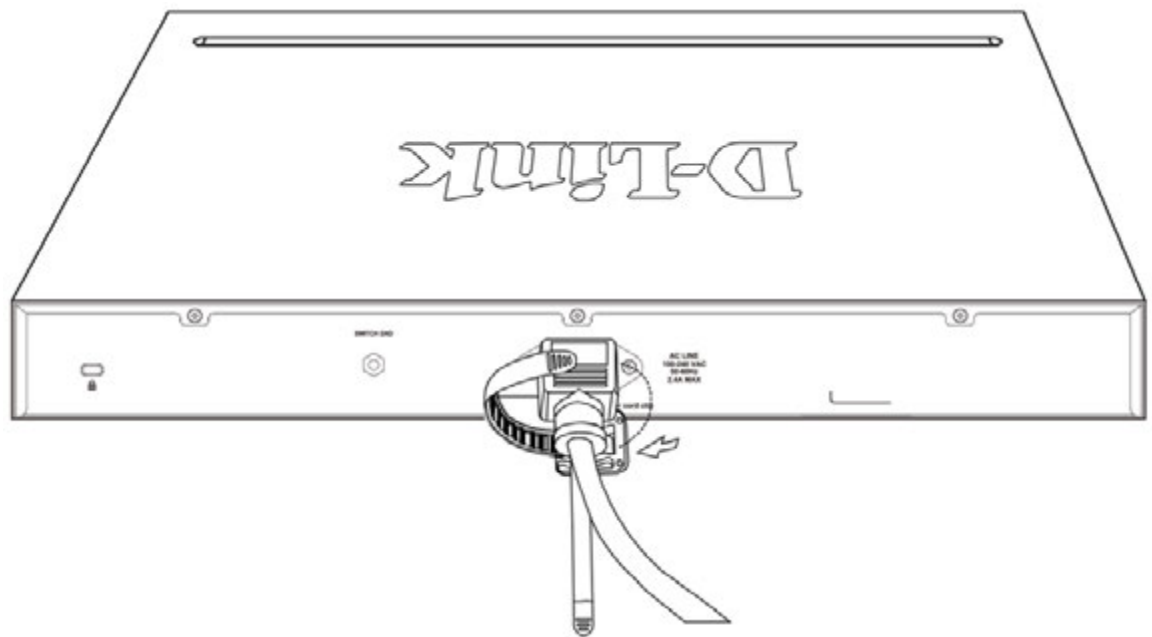

Figure 2-8 Circle around the power cord

5. Fasten the tie of the Retainer until the power cord is secured.

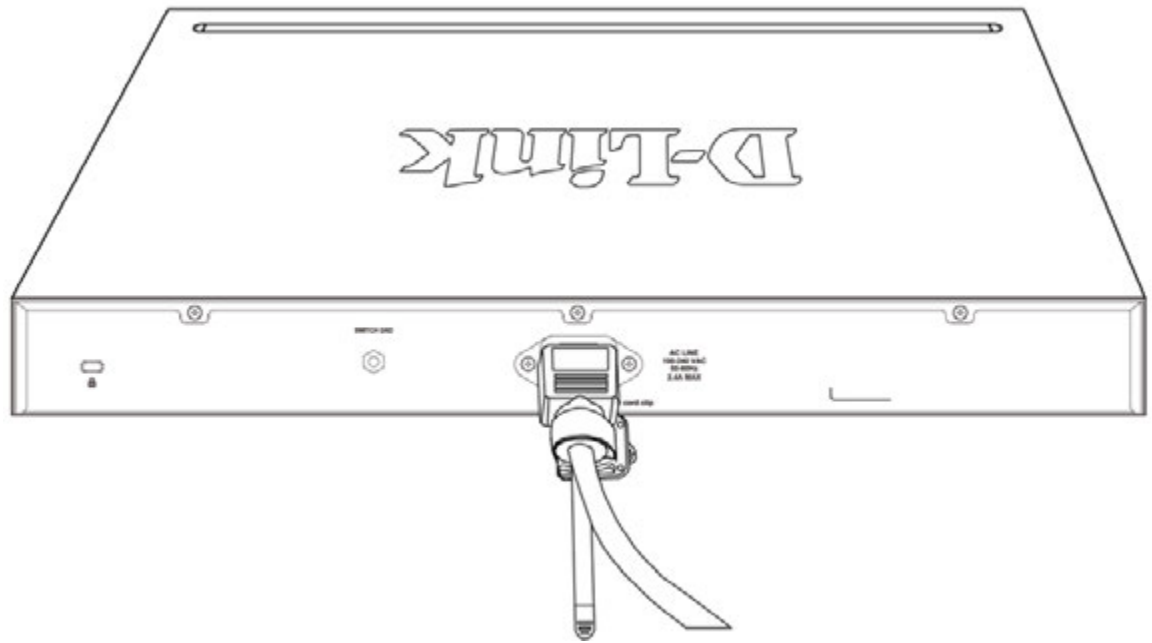

Figure 2-9 Secure the power cord



## 3. Connecting the Switch

### **Switch to End Node**

#### **Switch to another Switch**

#### **Connect to a Network Backbone or Server**

### Switch to End Node

An End Node can be any networking device, plugged into any of the networking ports of the Switch, where data transmission ends. Typical end nodes are computers. End nodes are generally outfitted with a 10/100/1000Mbps RJ-45 Ethernet Network Interface Card (NIC) that can connect to the Switch via a twisted-pair UTP/STP cable. Connect the end node to any of the copper ports of the Switch. The Link/Act LEDs for each Ethernet port turns green or amber when the link is active. A blinking LED indicates packet activity on that port.

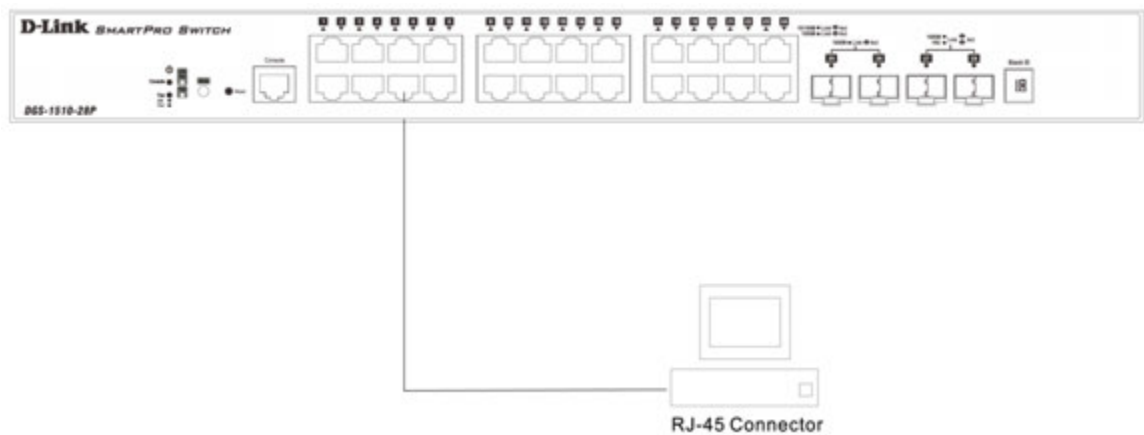

Figure 3–1 End Node to Switch Connection

### Switch to another Switch

There is a great deal of flexibility on how connections are made using the appropriate cabling.

- Connect a 10BASE-T switch port to the Switch via a twisted-pair Category 3, 4 or 5 UTP/STP cable.
- Connect a 100BASE-TX switch port to the Switch via a twisted-pair Category 5 UTP/STP cable.
- Connect 1000BASE-T switch port to the Switch via a twisted pair Category 5e UTP/STP cable.
- Connect switch supporting a fiber-optic uplink to the Switch's SFP ports via fiber-optic cabling.

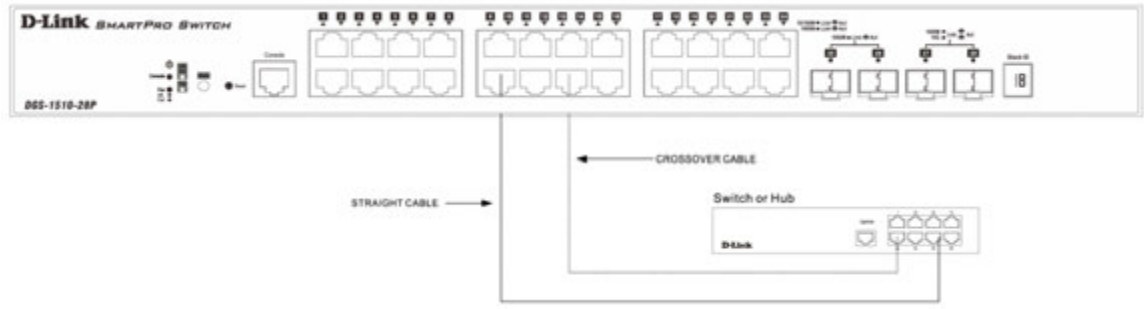

Figure 3–2 Switch to Switch Connection

## Connect to a Network Backbone or Server

The Combo Copper/SFP ports are ideal for connecting a network backbone, server or server farm to the Switch. The copper ports operate at a speed of 10/100/1000Mbps in half-duplex or full-duplex mode. The fiber-optic ports can operate at both 100/1000Mbps in full-duplex mode. The Link LED turns green when a connection is made.

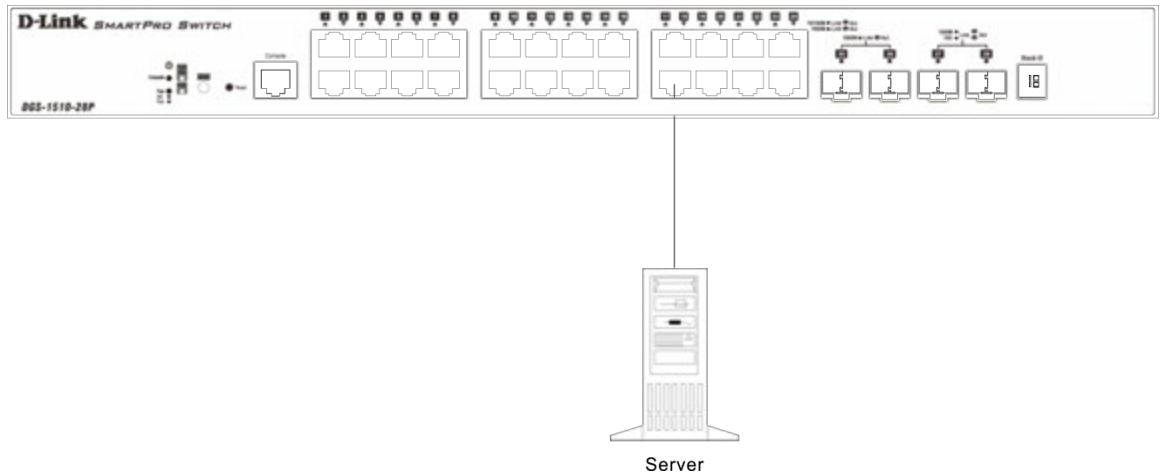

Figure 3–3 Server to Switch Connection

## 4. Introduction to Switch Management

**Management Options**  
**Connecting the Console Port**  
**SNMP Settings**

### Management Options

This Switch can be managed, out-of-band, through the console port on the front panel or in-band using Telnet. Alternatively, the web-based management can be used, accessible through a web browser.

#### **Command Line Interface (CLI) Management**

The user can connect a computer or terminal to the serial console port to access the Switch. The Command Line Interface (CLI) provides complete access to all Switch management features. When connecting to the Switch by means of Telnet or SSH, the same CLI can be accessed for Switch management. For more detailed information about the CLI, refer to the *CLI Reference Guide*.

#### **SNMP-based Management**

The Switch can also be managed with an SNMP-compatible console program. The Switch supports SNMP version 1.0, 2.0 and 3.0. The SNMP agent decodes the incoming SNMP messages and responds to requests with MIB objects stored in the database. The SNMP agent updates the MIB objects to generate statistics and counters.

#### **Web-based User Interface (Web UI) Management**

The user can connect a computer to any one of the frontal ports of the Switch, other than the console port, to access the Web UI of the Switch by means of a Web browser and entering the IP address of the Switch. This management interface is a more graphical representation of the features that can be viewed and configured on this Switch. Most of the features available from the CLI can be accessed through the Web UI. Web browsers like Microsoft's Internet Explorer, Mozilla Firefox or Google Chrome can be used. For more detailed information about the Web UI, refer to the *Web UI Reference Guide*.

### Connecting the Console Port

This section describes how to access the CLI through the serial port. To connect to the serial port, a special **Console Cable** must be used. This cable is included with this product's packaging. The cable referred to as an RS-232 to RJ-45 connector cable specifically pinned to connect to this switch's serial port by using the correct pin configuration. For more information about the pin layout of this cable, refer to **Appendix B**.

To connect to the console port of the Switch, use the following steps:

1. Connect the RS-232 end of the console cable to the **Serial Port** of the management PC.
2. Connect the RJ-45 end of the console cable to the **Console Port** of the Switch.
3. Open the **HyperTerminal** application (or any terminal emulation program capable of emulating a VT-100 terminal connection) on the management PC and configure the **Properties** of this connection.

- a. The **Bits per second** should be **115200** baud.
- b. The **Data bits** should be **8**.
- c. The **Parity** should be **None**.
- d. The **Stop bits** should be **1**.
- e. The **Flow control** should be **None**.

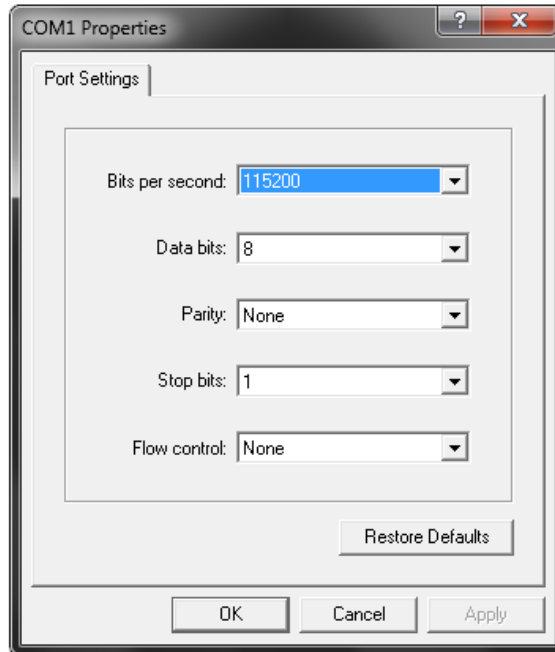

**Figure 4-1 Hyperterminal Connection Properties**

4. Now the Switch can be turned on and access to the Switch's CLI will be available.



**NOTE:** Access to the console port can be made at any time while the Switch is on. There is no need to turn the Switch off when plugging the console cable into the console port.

## Connecting to the Switch for the First Time

After successfully connecting to the Switch's console and the Switch was turned on, the boot-up procedure will be displayed, as shown below.

```
Boot Procedure V1.00.009
-----
Power On Self Test ..... 100 %

MAC Address   : 00-01-02-03-04-00
H/W Version   : A1

Please Wait, Loading V1.10.001 Runtime Image ..... 100 %
UART init ..... 100 %
Starting runtime image
Device Discovery ..... 100 %
Configuration init ..... 100 %

Switch con0 is now available

Press any key to login...
```

During the boot-up procedure, we can find the PROM version, MAC address, Hardware Version, and Firmware Version used by this Switch.

By default, there is no login username or password configured on this Switch. The CLI prompt will immediately be available, as shown below.

```
DGS-1510-28P Gigabit Ethernet SmartPro Switch

Command Line Interface
Firmware: Build 1.10.001
Copyright(C) 2014 D-Link Corporation. All rights reserved.

Switch>
```

Now the switch can be configured.



**CAUTION:** For security reasons, it is highly recommended to configure a personal username and password for this Switch.

## Creating a User Account

This section will discuss how to create a login username and password on this Switch. This login details will be applied not only for access to the CLI, but also for access to the Web UI, Telnet, SSH, and SSL interfaces. The same username and password will be used for these connections.

By default, there are no user accounts configured on this Switch. To create a user account, enter the following commands.

```
Switch> enable
Switch# configure terminal
Switch(config)# username Administrator password 12345
Switch(config)# username Administrator privilege 15
Switch(config)# line console
Switch(config-line)# login local
Switch(config-line)#
```

In the above example,

1. We accessed the **Privileged EXEC Mode** by entering the command **enable**.
2. Then we entered the **Global Configuration Mode** by entering the command **configure terminal**.
3. Then we created a user account with the username of '**Administrator**' and gave it the password of '**12345**' by entering the command **username Administrator password 12345**.
4. Then we assigned the privilege level of 15 to this user account by entering the command **username Administrator privilege 15**. The highest level access is 15 and the lowest level access is 1.
5. Then we entered the **LINE Configuration Mode** by entering the command **line console**.
6. Then we configured the Switch to allow access to the management interface by using locally configured user accounts. The command is **login local**.



**NOTE:** CLI configuration commands only modify the running configuration file and are not saved when the Switch is rebooted. To save all your configuration changes in non-volatile storage, you must use the **copy running-configuration start-up-configuration** command to copy the running configuration file to the start-up configuration. For more information, refer to the *CLI Reference Guide*.

## Configuring the IP Address

Each networking node, within a network, must use a unique IP Address. This IP address is used to communicate with other networking devices in the network. The IP address of the Switch is also important to be able to access the Web UI of this Switch. There are two methods in which a Switch can obtain an IP address.

1. The Switch can obtain an IP address from a DHCP server located within the local network. By default, this option is not enabled.
2. The administrator can manually configure an IP address for this Switch.

To find out what the IP address of the Switch is, we again need to access the Switch management interface through the CLI. Take note of the following example.

```
Switch> show ip interface

Interface vlan1 is enabled, Link status is down
  IP Address is 10.90.90.90/8 (Manual)
  ARP timeout is 20 minutes.
  Proxy ARP is disabled
  IP Local Proxy ARP is disabled
  gratuitous-send is disabled, interval is 0 seconds

Total Entries: 1

Switch>
```

In the above example, the command **show ip interface** is used to display information about the IP interfaces created on this Switch. In this display we see that the IP address for this switch is **10.90.90.90** and the CIDR notation for the subnet mask is **/8** which translates to **255.0.0.0**. This information can however be modified, as show below.

```
Switch> enable
Switch# configure terminal
Switch(config)# interface vlan 1
Switch(config-if)# ip address 192.168.1.1 255.255.255.0
Switch(config-if)#
```

In the above example,

1. We accessed the **Privileged EXEC Mode** by entering the command **enable**.
2. Then we entered the **Global Configuration Mode** by entering the command **configure terminal**.
3. Then we entered the **VLAN Configuration Mode** of the default VLAN, which is VLAN 1, by entering the command **interface vlan 1**.
4. Then we changed the IP address of the Switch to 192.168.1.1 and the subnet mask to 255.255.255.0 by entering the command **ip address 192.168.1.1 255.255.255.0**.

## SNMP Settings

The Simple Network Management Protocol (SNMP) is an OSI Layer 7 (Application Layer) designed specifically for managing and monitoring network devices. SNMP enables network management stations to read and modify the settings of gateways, routers, switches and other network devices. Use SNMP to configure system features for proper operation, monitor performance and detect potential problems in the Switch, switch group or network.

Managed devices that support SNMP include software (referred to as an agent), which runs locally on the device. A defined set of variables (managed objects) is maintained by the SNMP agent and used to manage the device. These objects are defined in a Management Information Base (MIB), which provides a standard presentation of the information controlled by the on-board SNMP agent. SNMP defines both the format of the MIB specifications and the protocol used to access this information over the network.

The Switch supports SNMP versions 1, 2c, and 3. The administrator may specify which SNMP version to use to monitor and control the Switch. The three SNMP versions vary in the level of security provided between the management station and the network device.

In SNMPv1 and SNMPv2, user authentication is accomplished using 'community strings', which function like passwords. The remote user SNMP application and the Switch SNMP must use the same community string. SNMP packets from any station that has not been authenticated are ignored (dropped).

The default community strings for the Switch used for SNMPv1 and SNMPv2 management access are:

- **public** - Allows authorized management stations to retrieve MIB objects.
- **private** - Allows authorized management stations to retrieve and modify MIB objects.

SNMPv3 uses a more sophisticated authentication process that is separated into two parts. The first part is to maintain a list of users and their attributes that are allowed to act as SNMP managers. The second part describes what each user on that list can do as an SNMP manager.

The Switch allows groups of users to be listed and configured with a shared set of privileges. The SNMP version may also be set for a listed group of SNMP managers. Thus, a group of SNMP managers can be created to view read-only information or receive traps using SNMPv1 while assigning a higher level of security to another group, granting read/write privileges using SNMPv3.

Using SNMPv3 individual users or groups of SNMP managers can be allowed to perform or be restricted from performing specific SNMP management functions. The functions allowed or restricted are defined using the Object Identifier (OID) associated with a specific MIB. An additional layer of security is available for SNMPv3 in that SNMP messages may be encrypted.

## Traps

Traps are messages that alert network personnel of events that occur on the Switch. The events can be as serious as a reboot (someone accidentally turned OFF the Switch), or less serious like a port status change. The Switch generates traps and sends them to the trap recipient (or network manager). Typical traps include trap messages for Authentication Failure, Topology Change and Broadcast\Multicast Storm.

## Management Information Base (MIB)

The Switch in the Management Information Base (MIB) stores management and counter information. The Switch uses the standard MIB-II Management Information Base module. Consequently, values for MIB objects can be retrieved from any SNMP-based network management software. In addition to the standard MIB-II, the Switch also supports its own proprietary enterprise MIB as an extended Management Information Base. The proprietary MIB may also be retrieved by specifying the MIB Object Identifier. MIB values can be either read-only or read-write.



**NOTE:** For customers interested in D-View, D-Link Corporation's proprietary SNMP management software, go to <http://dview.dlink.com.tw/> and download the software and manual.



## D-Link Network Assistant (DNA)

The **D-Link Network Assistant (DNA)**, included in the installation CD, is a program that allows administrators to quickly discover all **D-Link Switches** and **D-Link Discover Protocol (DDP)** supported devices that are in the same subnet as the management computer to collect traps and log messages and provide quick access to basic configurations of the switch. This utility can only be used on computers running Microsoft's Windows 7, Vista, XP, or 2000 on both 32bit and 64bit systems. There are two options for the installation of the DNA; one is through the **Autorun** program on the installation CD and the other is manual installation.



**NOTE:** Please be sure to uninstall any existing DNA from your PC before installing the latest DNA.

For detailed explanations of the DNA functions and a list of supported DDP devices, refer to the *D-Link Network Assistant (DNA) User Guide*.

## 5. Web-based Switch Configuration

### *Introduction*

### *Logging onto the Web Manager*

### *Web-based User Interface*

## Introduction

Most software functions of the Switch can be managed, configured, and monitored via the embedded Web-based (HTML) interface. Manage the Switch from remote stations anywhere on the network through a standard browser, such as Internet Explorer (version 5.5 and later), Mozilla Firefox (version 3 and later), Chrome (version 5 and later), or Safari (version 4 and later). The browser acts as a universal access tool and can communicate directly with the Switch using the HTTP protocol.

## Logging onto the Web Manager

To begin managing the Switch, simply run the browser installed on your computer and point it to the IP address you have defined for the device. The URL in the address bar should be in the format of `http://123.123.123.123`, where the numbers 123 represent the IP address of the Switch.



**NOTE:** The factory default IP address is 10.90.90.90.

This opens the user authentication window, as seen below. The following example is from 10.90.90.90.

Connect to 10.90.90.90

User Name

Password

Language

Login Reset

Figure 5–1 Enter Network Password Window

Leave the **User Name** and **Password** fields blank and click **Login**. This will open the Web-based user interface. The Switch management features available in the web-based manager are explained below.

# Web-based User Interface

The user interface provides access to various Switch configuration and management windows, it allows the user to view performance statistics, and permits graphical monitoring of the system status.

## Areas of the User Interface

The figure below shows the user interface. Three distinct areas divide the user interface, as described in the table.

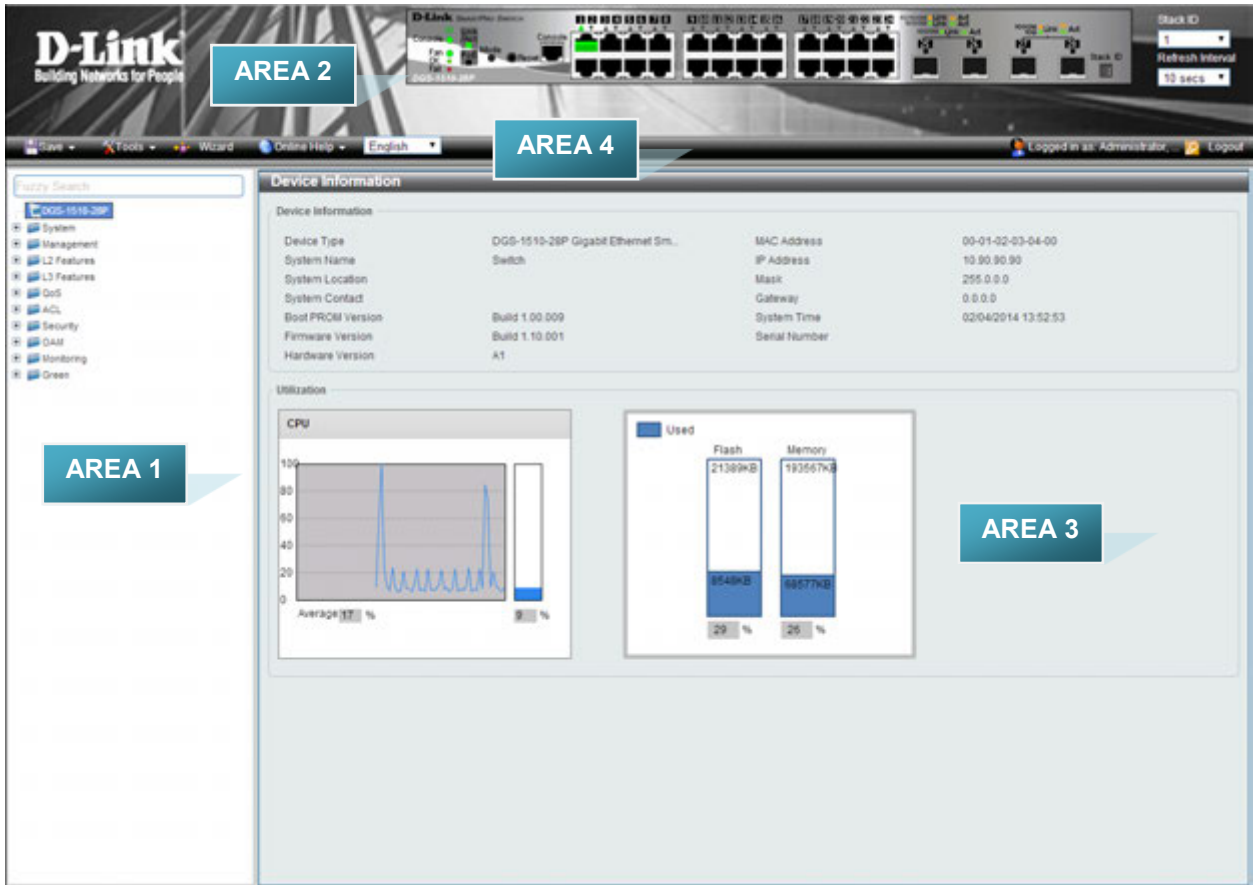

Figure 5-2 Main Web-manager Window

Area	Function
<b>AREA 1</b>	Select the folder or window to display. Open folders and click the hyperlinked window buttons and subfolders contained within them to display windows.
<b>AREA 2</b>	Presents a graphical near real-time image of the front panel of the Switch. This area displays the Switch's ports and expansion modules and shows port activity, depending on the specified mode. Some management functions, including port monitoring are accessible here. Click the D-Link logo to go to the D-Link Website.
<b>AREA 3</b>	Presents Switch status based on user selection and the entry of configuration data. In addition, hyperlinks are offered for many Switch

	features to enable quick configuration.
<b>AREA 4</b>	Presents a toolbar used to access function like <b>Save</b> , <b>Tools</b> , the <b>Wizard</b> , <b>Online Help</b> , and <b>Language</b> preference.

## Web Pages

When connecting to the management mode of the Switch with a Web browser, a login screen is displayed. Enter a user name and password to access the Switch's management mode.

Below is a list of the main folders available in the Web interface:

<b>System</b>	In this section the user will be able to configure features regarding the Switch's configuration.
<b>Management</b>	In this section the user will be able to configure features regarding the Switch's management.
<b>L2 Features</b>	In this section the user will be able to configure features regarding the Layer 2 functionality of the Switch.
<b>L3 Features</b>	In this section the user will be able to configure features regarding the Layer 3 functionality of the Switch.
<b>QoS</b>	In this section the user will be able to configure features regarding the Quality of Service functionality of the Switch.
<b>ACL</b>	In this section the user will be able to configure features regarding the Access Control List functionality of the Switch.
<b>Security</b>	In this section the user will be able to configure features regarding the Switch's security.
<b>OAM</b>	In this section the user will be able to configure features regarding the Switch's operations, administration and maintenance (OAM).
<b>Monitoring</b>	In this section the user will be able to monitor the Switch's configuration and statistics.
<b>Green</b>	In this section the user will be able to view and configure the Switch's power saving and Energy Efficient Ethernet (EEE) features.

# Appendix A – Technical Specifications

## General

Feature	Detailed Description		
<b>Standards</b>	IEEE 802.1AB Link Layer Discovery Protocol. IEEE 802.1D-2004 Spanning Tree Protocol. IEEE 802.1p Priority Queues. IEEE 802.1Q-2005 Virtual LAN. IEEE 802.1S Multiple Spanning Tree Protocol. IEEE 802.1W Rapid Spanning Tree Protocol. IEEE 802.1X Port-based Authentication.  IEEE 802.3i 10BASE-T Ethernet. IEEE 802.3u 100BASE-TX Fast Ethernet. IEEE 802.3ab 1000BASE-T Gigabit Ethernet. IEEE 802.3ad Link Aggregation. IEEE 802.3ae 10GBASE-X/10GBASE-R/10GBASE-W. IEEE 802.3af Power over Ethernet. IEEE 802.3at Power over Ethernet. IEEE 802.1az Energy-Efficient Ethernet. IEEE 802.3x Flow Control support for Full-Duplex mode. IEEE 802.3z 1000BASE-T Gigabit Ethernet.		
<b>Data Transfer Rates</b>		<b>Half-duplex</b>	<b>Full-duplex</b>
	<b>Ethernet</b>	10Mbps	20Mbps
	<b>Fast Ethernet</b>	100Mbps	200Mbps
	<b>Gigabit Ethernet</b>	-----	2Gbps
	<b>10 Gigabit Ethernet</b>	-----	20Gps
<b>Stacking Topology</b>	Duplex Ring, Duplex Chain		
<b>Network Cables</b>	UTP/STP Category 3, 4, 5 for 10BASE-T UTP/STP Category 5 Enhanced for 1000BASE-T UTP/STP Category.5, 5 Enhanced for 100BASE-TX EIA/TIA-568 100Ω screened twisted-pair (STP) (100m)		

## Physical and Environmental

Feature	Detailed Description
<b>Internal Power Supply</b>	<p><b>DGS-1510-20:</b> 100-240 VAC, 50/60 Hz, 24 Watt.</p> <p><b>DGS-1510-28:</b> 100-240 VAC, 50/60 Hz, 30 Watt.</p> <p><b>DGS-1510-28P:</b> 100-240 VAC, 50/60 Hz, 253 Watt.</p> <p><b>DGS-1510-28X:</b> 100-240 VAC, 50/60 Hz, 30 Watt.</p> <p><b>DGS-1510-52:</b> 100-240 VAC, 50/60 Hz, 54 Watt.</p> <p><b>DGS-1510-52X:</b> 100-240 VAC, 50/60 Hz, 54 Watt.</p>
<b>Fans</b>	<p>The IC Sensor detects the temperature on the switch automatically, and adjusts the speed. The amount of fans that are installed per Switch are listed below:</p> <p><b>DGS-1510-20:</b> 1 Fan.</p> <p><b>DGS-1510-28:</b> 1 Fan.</p> <p><b>DGS-1510-28P:</b> 2 Fans.</p> <p><b>DGS-1510-28X:</b> 1 Fan.</p> <p><b>DGS-1510-52:</b> 2 Fans.</p> <p><b>DGS-1510-52X:</b> 2 Fans.</p>
<b>Maximum Power Consumption</b>	<p><b>DGS-1510-20:</b> 20.3 Watt.</p> <p><b>DGS-1510-28:</b> 24.0 Watt.</p> <p><b>DGS-1510-28P:</b> 29.0 Watt (PoE off). 238.7 Watt (PoE on).</p> <p><b>DGS-1510-28X:</b> 22.3 Watt.</p> <p><b>DGS-1510-52:</b> 38.4 Watt.</p> <p><b>DGS-1510-52X:</b> 44.22 Watt.</p>
<b>Standby Power Consumption</b>	<p><b>DGS-1510-20:</b> 11.4 Watt (100V). 12.2 Watt (240V).</p> <p><b>DGS-1510-28:</b> 14.6 Watt (100V). 15.2 Watt (240V).</p> <p><b>DGS-1510-28P:</b> 22.7 Watt (100V). 21.0 Watt (240V).</p> <p><b>DGS-1510-28X:</b> 14.6 Watt (100V). 15.2 Watt (240V).</p> <p><b>DGS-1510-52:</b> 27.3 Watt (100V). 27.6 Watt (240V).</p> <p><b>DGS-1510-52X:</b> 28.6 Watt (100V). 28.9 Watt (240V).</p>
<b>Temperature</b>	<p><b>Operating:</b> -5°C ~ 50°C (23°F ~ 122°F)</p> <p><b>Storage:</b> -20°C ~ 70°C (-4°F ~ 158°F)</p>
<b>Humidity</b>	<p><b>Operating:</b> 0% ~ 95% (non-condensing)</p> <p><b>Storage:</b> 0% ~ 95% (non-condensing)</p>
<b>Dimensions</b>	<p><b>DGS-1510-20:</b> 280mm (W) 180mm (D) 44mm (H)</p> <p><b>DGS-1510-28:</b> 440mm (W) 210mm (D) 44mm (H)</p> <p><b>DGS-1510-28P:</b> 440mm (W) 210mm (D) 44mm (H)</p>

	<b>DGS-1510-28X:</b> 440mm (W) 210mm (D) 44mm (H) <b>DGS-1510-52:</b> 440mm (W) 210mm (D) 44mm (H) <b>DGS-1510-52X:</b> 440mm (W) 210mm (D) 44mm (H)
<b>Weight</b>	<b>DGS-1510-20:</b> 1.235 kg <b>DGS-1510-28:</b> 2.000 kg <b>DGS-1510-28P:</b> 2.536 kg <b>DGS-1510-28X:</b> 2.000 kg <b>DGS-1510-52:</b> 2.400 kg <b>DGS-1510-52X:</b> 2.397 kg
<b>MTBF</b>	<b>DGS-1510-20:</b> 882152.3682 Hours <b>DGS-1510-28:</b> 516593.2513 Hours <b>DGS-1510-28P:</b> 243090.6950 Hours <b>DGS-1510-28X:</b> 516593.2513 Hours <b>DGS-1510-52:</b> 433434.1606 Hours <b>DGS-1510-52X:</b> 416789.0227 Hours
<b>EMI/EMC; Test Reports</b>	CE Class A, FCC Class A, VCCI Report Class A, C-Tick Report Class A, BSMI, CCC
<b>Safety Certifications and Test Reports</b>	UL/CSA 60950-1, IEC 60950-1:2001, BSMI

## Performance

Feature	Detailed Description
<b>Transmission Method</b>	Store-and-forward.
<b>Packet Buffer</b>	<b>DGS-1510-20/28/28P/28X:</b> 1.5 Mbytes per device. <b>DGS-1510-52/52X:</b> 3 MBytes per device.
<b>Wire Speed</b>	Wire speed operation on all FE/GE/10GE ports.
<b>Switching Capacity</b>	<b>DGS-1510-20:</b> 76 Gbps. <b>DGS-1510-28:</b> 92 Gbps. <b>DGS-1510-28P:</b> 92 Gbps. <b>DGS-1510-28X:</b> 128 Gbps. <b>DGS-1510-52:</b> 140 Gbps. <b>DGS-1510-52X:</b> 176 Gbps.
<b>64 Byte System Packet Forwarding Rate</b>	<b>DGS-1510-20:</b> 56.54 Mpps (Mega Packets Per Second) <b>DGS-1510-28:</b> 68.45 Mpps (Mega Packets Per Second)



	<b>DGS-1510-28P:</b> 68.45 Mpps (Mega Packets Per Second) <b>DGS-1510-28X:</b> 95.24 Mpps (Mega Packets Per Second) <b>DGS-1510-52:</b> 104.16 Mpps (Mega Packets Per Second) <b>DGS-1510-52X:</b> 130.95 Mpps (Mega Packets Per Second)
<b>Priority Queues</b>	8 Priority Queues per port.
<b>MAC Address Table</b>	Supports 16K MAC addresses. Supports 512 Static MAC addresses.
<b>Virtual Stacking / Clustering</b>	Supports D-Link Single IP Management version 1.6. Manage up to 32 devices in a virtual stack with a single IP address.

## LED Indicators

Location	LED Indicative	Color	Status	Description
Per Device	Power	Green	Solid Light	Power on.
			Blinking	Performing System Self-test.
			Light off	Power off.
	Console	Green	Solid Light	Console on.
			Light off	Console off.
	Fan	Green	Solid Light	Diagnostics pass. Normal operation.
		Red	Solid Light	Fan failure.
	Stacking ID	Green	Capable 1 – 6, H, h, E, G.	<p>The box ID is assigned either by user (static mode) or by the system (automatic mode). When the box become a primary master, the 7 segment works as bi-function. That is box ID and “H” indicate as primary Master and the display will be shown by turn.</p> <p>That is boxID -&gt; H -&gt; boxID -&gt; H.</p> <p>1-6: To indicate the stacking of the switch.</p> <p>H: When device was assigned as the stacking Master.</p> <p>h: When device was selected to be the Backup Master.</p> <p>E: Error was found during system self-test.</p> <p>G: When Safeguard Engine entering</p>

				the exhausted mode.
	<b>Port LED Mode Indicator</b>	A LED Mode Select Button to switch two modes in turn for all 10/100/1000Mbps ports on DGS-1510-28P: Link/Act/Speed Mode PoE Mode (Only DGS-1510-28P)		
		<b>Green</b>	Solid Light	A LED Mode Select Button to switch Link/Act/Speed Mode
			Solid Light	A LED Mode Select Button to switch PoE Mode
<b>LED Per 10/100/1000 Mbps Port</b>	<b>Link/Act/Speed Mode</b>	<b>Green</b>	Solid Light	When there is a secure connection (or link) to 1000Mbps Ethernet device at any of the ports.
			Blinking	When there is reception or transmission of data occurring at 1000Mbps.
		<b>Orange</b>	Solid Light	When there is a secure connection (or link) to 10/100Mbps Ethernet device at any of the ports.
			Blinking	When there is reception or transmission of data occurring at 10/100Mbps.
		<b>Off</b>	Light off	No link.
	<b>PoE Mode (Only DGS-1510-28P)</b>	<b>Green</b>	Solid Light	Power feeding.
		<b>Orange</b>	Solid Light	Error Condition.
<b>Off</b>		Light Off	No Power feeding.	
<b>LED per SFP Port</b>	<b>Link/Act</b>	<b>Green</b>	Solid Light	When there is a secure connection (or link) to 1000Mbps Ethernet device at any of the ports.
			Blinking	When there is reception or transmission of data occurring at 1000Mbps.
<b>LED per SFP+ Port</b>	<b>Link/Act</b>	<b>Green</b>	Solid Light	When there is a secure connection (or link) to 10G bps Ethernet device at any of the ports.
			Blinking	When there is reception or transmission (i.e. Activity--Act) of data occurring at a 10G bps port.
		<b>Orange</b>	Solid Light	When there is a secure connection (or link) to 1000Mbps Ethernet device at any of the ports.

		Blinking	When there is reception or transmission (i.e. Activity--Act) of data occurring at a 1000Mbps port.
	<b>Off</b>	Light off	Link down

## Port Functions

Feature	Detailed Description
<b>Console Port</b>	RJ-45 interface for Out-Of-Band (OOB) CLI configuration.
<b>Copper Ports</b>	<p>Compliant with the following standards:</p> <ul style="list-style-type: none"> <li>• IEEE 802.3 compliance</li> <li>• IEEE 802.3u compliance</li> <li>• IEEE 802.3ab compliance</li> <li>• IEEE 802.3az compliance (100/1000Mbps)</li> </ul> <p>Support Full-Duplex operations:</p> <ul style="list-style-type: none"> <li>• IEEE 802.3x Flow Control support for Full-Duplex mode</li> <li>• IEEE 802.3af compliance (DGS-1510-28P)</li> <li>• IEEE 802.3at compliance (DGS-1510-28P)</li> </ul>
<b>SFP Ports</b>	<p>Compliant with the following standards:</p> <ul style="list-style-type: none"> <li>• IEEE 802.3z compliance</li> </ul> <p><b>SFP Transceivers Supported:</b></p> <ul style="list-style-type: none"> <li>• DEM-302S-LX (1000BASE-LX, Single-mode, 2km)</li> <li>• DEM-310GT (1000BASE-LX, Single-mode, 10km)</li> <li>• DEM-311GT (1000BASE-SX, Mutli-mode, 550m)</li> <li>• DEM-312GT2 (1000BASE-SX, Multi-mode, 2km)</li> <li>• DEM-314GT (1000BASE-LHX, Single-mode, 50km)</li> <li>• DEM-315GT (1000BASE-ZX, Single-mode, 80km)</li> <li>• DGS-712 (1000BASE-TX)</li> </ul> <p><b>WDM Transceivers Supported:</b></p> <ul style="list-style-type: none"> <li>• DEM-302S-BXD/BCU (1000BASE-BX, Single-mode, 2km)</li> <li>• DEM-330T/R (1000BASE-BX, Single-Mode, 10km)</li> <li>• DEM-331T/R (1000BASE-BX, Single-Mode, 40km)</li> </ul>
<b>SFP+ Ports</b>	Compliant with the following standards:

	<ul style="list-style-type: none"> <li>• IEEE 802.3ae compliance</li> <li>• IEEE 802.3z compliance</li> </ul> <p><b>SFP Transceivers Supported:</b></p> <p>All SFP and WDM transceivers listed in the SFP Ports section (above) will also work in the SFP+ ports.</p> <p><b>SFP+ Transceivers Supported:</b></p> <ul style="list-style-type: none"> <li>• DEM-431XT-DD (10GBASE-SR SFP+ Transceiver, 80m: OM1 &amp; OM2 MMF 300m: OM3 MMF)</li> <li>• DEM-431XT (10GBASE-SR SFP+ Transceiver (w/o DDM), 80m: OM1 &amp; OM2 MMF 300m: OM3 MMF)</li> <li>• DEM-432XT-DD (10GBASE-LR SFP+ Transceiver, 10km)</li> <li>• DEM-432XT (10GBASE-LR SFP+ Transceiver (w/o DDM), 10km)</li> <li>• DEM-433XT-DD (10GBASE-ER SFP+ Transceiver, 40km)</li> <li>• DEM-433XT (10GBASE-ER SFP+ Transceiver (w/o DDM), 40km)</li> <li>• DEM-434XT (10GBASE-ZR SFP+ Transceiver (w/o DDM), 80km)</li> <li>• DEM-436XT-BXU (10GBASE-LR BiDi SFP+ Transceiver (w/o DDM), 20km, TX: 1270nm, RX: 1330nm)</li> <li>• DEM-436XT-BXD (10GBASE-LR BiDi SFP+ Transceiver (w/o DDM), 20km, TX: 1330nm, RX: 1270nm)</li> </ul> <p><b>SFP+ Direct Attached Cables (DAC) Supported:</b></p> <ul style="list-style-type: none"> <li>• DEM-CB100S-10-GbE (SFP+, 1m, Direct Attach Cable), for stacking.</li> <li>• DEM-CB300S-10-GbE (SFP+, 3m Direct Attach Cable), for stacking.</li> <li>• DEM-CB700S-10-GbE (SFP+, 7m Direct Attach Cable), for stacking.</li> </ul>
<p><b>PoE Ports (DGS-1510-28P Only)</b></p>	<ol style="list-style-type: none"> <li>1. Supports IEEE 802.3af PoE and IEEE 802.3at PoE+ compliance.</li> <li>2. Supplies power (ports 1 to 24) to PD devices up to 15.4 Watt per port (802.3af) or 30 Watt per port (802.3at) and more sufficiently is able to provide power to PD devices.</li> <li>3. The auto-discovery feature automatically recognizes the connection of the PD device and immediately provides power.</li> <li>4. Automatically disable ports if the port current is over 600mA while. Other ports will remain active.</li> <li>5. Active circuit protection automatically disables the port if there is a short while other ports remain active.</li> <li>6. For 802.3af/at capable devices it will provide the power for the following classifications below:</li> </ol>

	<b>Class</b>	<b>Usage</b>	<b>Max Power used by PD</b>
	0	Default	0.44 Watt to 12.95 Watt
	1	Optional	0.44 Watt to 3.84 Watt
	2	Optional	3.84 Watt to 6.49 Watt
	3	Optional	6.49 Watt to 12.95 Watt
	4	Optional (802.3at Only)	12.95 Watt to 25.5 Watt
	<p>7. Follow the PSE pin out standard. For an alternative solution, send the power over pins 1, 2, 3, 6 and 8 wires. Use Category 3, 6A UTP cable for 802.3af or Category 5e, 6A UTP cable for 802.3at.</p> <p>8. The DGS-1510-28P works with all D-Link 802.3af and 802.3at capable devices and with all non-802.3af and non-802.3at capable D-Link Access Points, IP Cameras and IP Phones.</p> <p>9. The total power budget is 193 Watts.</p>		

# Appendix B – Cables and Connectors

## Ethernet Cable

When connecting the Switch to another switch, a bridge or hub, a normal cable is necessary. Please review these products for matching cable pin assignment. The following diagrams and tables show the standard RJ-45 connector and their pin assignments.

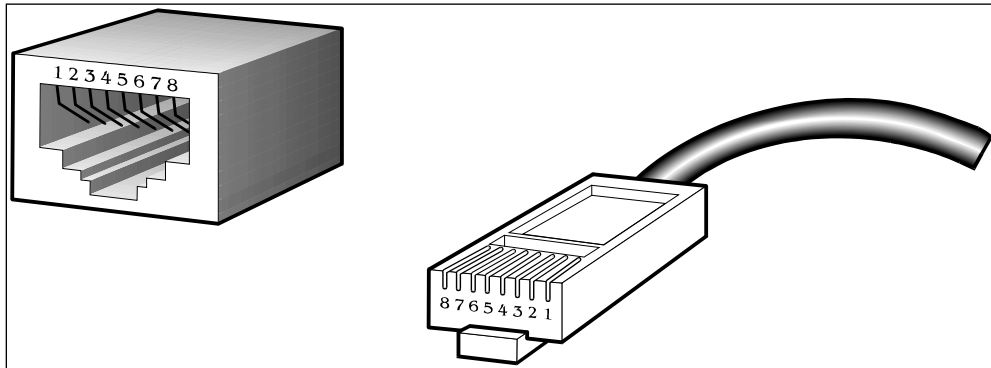

Figure B-1 Standard RJ-45 port and connector

### RJ-45 PIN Assignments:

Pin	MDI-X Port	MDI-II Port
1	RD+ (receive)	TD+ (transmit)
2	RD- (receive)	TD- (transmit)
3	TD+ (transmit)	RD+ (receive)
4	1000BASE-T	1000BASE-T
5	1000BASE-T	1000BASE-T
6	TD- (transmit)	RD- (receive)
7	1000BASE-T	1000BASE-T
8	1000BASE-T	1000BASE-T

## Console Cable

When connecting the Switch to a PC, a Console cable is necessary. The following diagrams and tables show the standard Console-to-DJ-45 receptacle/connector and their pin assignments.

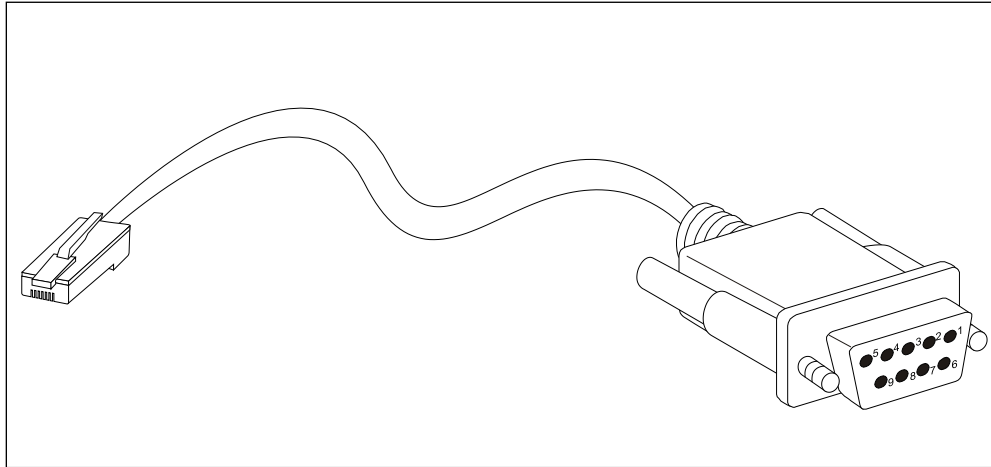

Figure B-2 Console-to-RJ-45 Cable

### Console-to-RJ-45 PIN Assignments:

Pin	Console (DB9/RS232)	RJ-45
1	Not Used	Not Used
2	RXD	Not Used
3	TXD	TXD
4	Not Used	GND
5	GND (shared)	GND
6	Not Used	RXD
7	Not Used	Not Used
8	Not Used	Not Used

# Tech Support

## Technical Support

You can find software updates and user documentation on the D-Link website.

D-Link provides free technical support for customers within the United States and within Canada for the duration of the service period, and warranty confirmation service, during the warranty period on this product. U.S. and Canadian customers can contact D-Link technical support through our website, or by phone.

### Tech Support for customers within the United States:

***D-Link Technical Support over the Telephone:***

USA - 877-DLINK-55 (877-354-6555)

***D-Link Technical Support over the Internet:***

<http://support.dlink.com>

### Tech Support for customers within Canada:

***D-Link Technical Support over the Telephone:***

877-354-6560

***D-Link Technical Support over the Internet:***

<http://support.dlink.com>





## Technical Support

### United Kingdom (Mon-Fri)

Home Wireless/Broadband 0871 873 3000 (9.00am–06.00pm, Sat 10.00am-02.00pm)  
Managed, Smart, & Wireless Switches, or Firewalls 0871 873 0909 (09.00am – 05.30pm)  
(BT 10ppm, other carriers may vary.)

### Ireland (Mon-Fri)

All Products 1890 886 899 (09.00am-06.00pm, Sat 10.00am-02.00pm)  
€ 0.05ppm peak, €0.045ppm off peak Times

### Internet

<http://www.dlink.com>

## Technische Unterstützung

Deutschland:	Web:	<a href="http://www.dlink.com">http://www.dlink.com</a>
	Telefon:	+49(0)1805 2787 0,14 € pro Minute
	Zeiten:	Mo. –Fr. 09:00 – 17:30 Uhr
Österreich:	Web:	<a href="http://www.dlink.com">http://www.dlink.com</a>
	Telefon:	+43(0)820 480084 0,116 € pro Minute
	Zeiten:	Mo. –Fr. 09:00 – 17:30 Uhr
Schweiz:	Web:	<a href="http://www.dlink.com">http://www.dlink.com</a>
	Telefon:	+41(0)848 331100 0,08 CHF pro Minute
	Zeiten:	Mo. –Fr. 09:00 – 17:30 Uhr

\* Gebühren aus Mobilnetzen und von anderen Providern können abweichen.

## Assistance technique

Assistance technique D-Link sur internet : <http://www.dlink.com>

Assistance technique D-Link par téléphone : 01 76 54 84 17

Du lundi au vendredi de 9h à 19h (hors jours fériés)

## Asistencia Técnica

Asistencia Técnica Telefónica de D-Link: +34 902 30 45 45

0,067 €/min

De Lunes a Viernes de 9:00 a 19:00

<http://www.dlink.com>

## Supporto tecnico

Supporto Tecnico dal lunedì al venerdì dalle ore 9.00 alle ore 19.00 con orario continuato

Telefono: 02 87366396

<http://www.dlink.com>

## TECHNISCHE ONDERSTEUNING

Technische ondersteuning voor klanten in Nederland:

<http://www.dlink.com> / 0107994325 / €0.15per minuut.

Tech Support for customers within Belgium:

<http://www.dlink.com> / 028801640 / €0.175per minuut(spitsuren), €0.0875per minuut(daluren)

Technische ondersteuning voor klanten in Luxemburg:

<http://www.dlink.com> / +32 70 66 06 40

## Pomoc techniczna

Telefoniczna pomoc techniczna firmy D-Link: 0 801 022 021  
Pomoc techniczna firmy D-Link świadczona przez Internet:  
<http://www.dlink.com>

## Technická podpora

Web: <http://www.dlink.com>  
E-mail: [support@dlink.cz](mailto:support@dlink.cz)  
Telefon ČR: +420 211 151 640 nebo SK: +421 (0)692 147 110  
Telefonická podpora je v provozu: PO - PÁ od 09:00 do 17:00  
Volání je zpoplatněno dle příslušných tarifů Vašeho operátora.

## Technikai Támogatás

URL : <http://www.dlink.com>  
Tel. : 06 80 315-465  
Ingyenes zöld szám

## Teknisk Support

D-Link Teknisk Support over Internett: <http://www.dlink.com>  
D-Link Teknisk telefonsupport: 815 69 755  
(Hverdager 08:00 - 17:00)

## Teknisk Support

D-Link teknisk support over telefonen: Tlf.: 702 690 40  
Normale åbningstider: Hverdage kl. 08:00 - 17:00  
D-Link teknisk support på Internettet: <http://www.dlink.com>

## **Teknistä tukea asiakkaille Suomessa:**

Internetin kautta : <http://www.dlink.com>

Arkisin klo. 09:00 - 18: 00

Numerosta : 0200-555 57

## **Teknisk Support**

D-Link Teknisk Support via Internet: <http://www.dlink.com>

D-Link Teknisk Support via telefon: 0770-33 00 35

Vardagar 08:00 - 17:00

## **Assistência Técnica**

Assistência Técnica da D-Link na Internet:

<http://www.dlink.com>

e-mail: [soporte@dlink.es](mailto:soporte@dlink.es)

## **Τεχνική Υποστήριξη**

D-Link Hellas Support Center

<http://www.dlink.com>

Καλύμνου 12, 112 51, Αθήνα

Τηλ. 213 0020353 (Δευτέρα - Παρασκευή, 09.00 - 19.00)

Fax. 210 8653172

## **Tehnička podrška**

Hvala vam na odabiru D-Link proizvoda. Za dodatne informacije, podršku i upute za korištenje uređaja, molimo vas da posjetite D-Link internetsku stranicu na [www.dlink.eu](http://www.dlink.eu)  
<http://www.dlink.com>

## **Tehnična podpora**

Zahvaljujemo se vam, ker ste izbrali D-Link proizvod. Za vse nadaljnje informacije, podporo ter navodila za uporabo prosimo obiščite D-Link - ovo spletno stran [www.dlink.eu](http://www.dlink.eu)  
<http://www.dlink.com>

## **Suport tehnic**

Vă mulțumim pentru alegerea produselor D-Link. Pentru mai multe informații, suport și manuale ale produselor vă rugăm să vizitați site-ul D-Link [www.dlink.eu](http://www.dlink.eu)  
<http://www.dlink.com>

# Technical Support

You can find software updates and user documentation on the D-Link website.

## Tech Support for customers in

### Australia:

Tel: 1300-766-868  
24/7 Technical Support  
Web: <http://www.dlink.com.au>  
E-mail: [support@dlink.com.au](mailto:support@dlink.com.au)

### India:

Tel: +91-832-2856000  
Toll Free 1800-233-0000  
Web: [www.dlink.co.in](http://www.dlink.co.in)  
E-Mail: [helpdesk@dlink.co.in](mailto:helpdesk@dlink.co.in)

### Singapore, Thailand, Indonesia, Malaysia, Philippines, Vietnam:

Singapore - [www.dlink.com.sg](http://www.dlink.com.sg)  
Thailand - [www.dlink.co.th](http://www.dlink.co.th)  
Indonesia - [www.dlink.co.id](http://www.dlink.co.id)  
Malaysia - [www.dlink.com.my](http://www.dlink.com.my)  
Philippines - [www.dlink.com.ph](http://www.dlink.com.ph)  
Vietnam - [www.dlink.com.vn](http://www.dlink.com.vn)

### Korea:

Tel : +82-2-2028-1810  
Monday to Friday 9:00am to 6:00pm  
Web : <http://d-link.co.kr>  
E-mail : [g2b@d-link.co.kr](mailto:g2b@d-link.co.kr)

### New Zealand:

Tel: 0800-900-900  
24/7 Technical Support  
Web: <http://www.dlink.co.nz>  
E-mail: [support@dlink.co.nz](mailto:support@dlink.co.nz)

### South Africa and Sub Sahara Region:

Tel: +27 12 661 2065  
08600 DLINK (for South Africa only)  
Monday to Friday 8:30am to 9:00pm South Africa Time  
Web: <http://www.d-link.co.za>  
E-mail: [support@d-link.co.za](mailto:support@d-link.co.za)

### D-Link Middle East - Dubai, U.A.E.

Plot No. S31102,  
Jebel Ali Free Zone South,  
P.O.Box 18224, Dubai, U.A.E.  
Tel: +971-4-8809022  
Fax: +971-4-8809066 / 8809069  
Technical Support: +971-4-8809033  
General Inquiries: [info.me@dlinkmea.com](mailto:info.me@dlinkmea.com)  
Tech Support: [support.me@dlinkmea.com](mailto:support.me@dlinkmea.com)

### Egypt

1, Makram Ebeid Street - City Lights Building  
Nasrcity - Cairo, Egypt  
Floor 6, office C2  
Tel.: +2 02 26718375 - +2 02 26717280  
Technical Support: +2 02 26738470  
General Inquiries: [info.eg@dlinkmea.com](mailto:info.eg@dlinkmea.com)  
Tech Support: [support.eg@dlinkmea.com](mailto:support.eg@dlinkmea.com)

### Kingdom of Saudi Arabia

Office # 84 ,  
Al Khaleej Building ( Mujamathu Al-Khaleej)  
Opp. King Fahd Road, Olaya  
Riyadh - Saudi Arabia  
Tel: +966 1121 70008  
Technical Support:  
+966 1121 70009  
General Inquiries: [info.sa@dlinkmea.com](mailto:info.sa@dlinkmea.com)  
Tech Support: [support.sa@dlinkmea.com](mailto:support.sa@dlinkmea.com)

### Pakistan

Islamabad Office:  
61-A, Jinnah Avenue, Blue Area,  
Suite # 11, EBC, Saudi Pak Tower,  
Islamabad - Pakistan  
Tel.: +92-51-2800397, 2800398  
Fax: +92-51-2800399

### Karachi Office:

D-147/1, KDA Scheme # 1,  
Opposite Mudassir Park, Karsaz Road,  
Karachi – Pakistan  
Phone: +92-21-34548158, 34326649  
Fax: +92-21-4375727  
Technical Support: +92-21-34548310, 34305069  
General Inquiries: [info.pk@dlinkmea.com](mailto:info.pk@dlinkmea.com)  
Tech Support: [support.pk@dlinkmea.com](mailto:support.pk@dlinkmea.com)

## Technical Support

You can find software updates and user documentation on the D-Link website.

### Tech Support for customers in

#### Iran

Unit 5, 5th Floor, No. 20, 17th Alley , Bokharest  
St. , Argentine Sq. ,  
Tehran IRAN  
Postal Code : 1513833817  
Tel: +98-21-88880918,19  
+98-21-88706653,54  
General Inquiries: info.ir@dlinkmea.com  
Tech Support: support.ir@dlinkmea.com

#### Morocco

M.I.T.C  
Route de Nouaceur angle RS et CT 1029  
Bureau N° 312 ET 337  
Casablanca , Maroc  
Phone : +212 663 72 73 24  
Email: support.na@dlinkmea.com

#### Lebanon RMA center

Dbayeh/Lebanon  
PO Box:901589  
Tel: +961 4 54 49 71 Ext:14  
Fax: +961 4 54 49 71 Ext:12  
Email: taoun@dlinkmea.com

#### Bahrain

Technical Support: +973 1 3332904

#### Kuwait:

Technical Support: + 965 22453939 / +965  
22453949

#### Türkiye Merkez İrtibat Ofisi

Ayazağa Maslak yolu  
Erdebil Cevahir İş Merkezi No: 5/A Ayazağa /  
Maslak İstanbul  
Tel: +90 212 2895659  
Ücretsiz Müşteri Destek Hattı: 0 800 211 00 65  
Web:www.dlink.com.tr  
Teknik Destek: support.tr@dlink.com.tr

#### Israel

רח' המגשימים 20  
קרית מטלון, פ"ת 49348  
ת.ד. 7060  
טלפון: 073-796-2797  
אי-מאייל כללי: info@dlink.co.il  
אי-מאייל תמיכה: support@dlink.co.il

## Техническая поддержка

Обновления программного обеспечения и документация доступны на Интернет-сайте D-Link. D-Link предоставляет бесплатную поддержку для клиентов в течение гарантийного срока. Клиенты могут обратиться в группу технической поддержки D-Link по телефону или через Интернет.

### Техническая поддержка D-Link:

8-800-700-5465

### Техническая поддержка через Интернет:

<http://www.dlink.ru>

e-mail: [support@dlink.ru](mailto:support@dlink.ru)

## Офисы

### Россия

129626 г. Москва

Графский пер., 14

Тел.: +7 (495) 744-0099

### Украина,

04080 г. Киев, ул. Межигорская, 87-А, офис 18

Тел.: +38 (044) 545-64-40

E-mail: [kiev@dlink.ru](mailto:kiev@dlink.ru)

### Беларусь

220114, г. Минск, проспект Независимости, 169, БЦ "XXI Век"

Тел.: +375(17) 218-13-65

E-mail: [minsk@dlink.ru](mailto:minsk@dlink.ru)

### Казахстан,

050008, г. Алматы, ул. Курмангазы, 143

(уг. Муқанова)

Тел./факс: +7 727 378-55-90

E-mail: [almaty@dlink.ru](mailto:almaty@dlink.ru)

### Армения

0038, г. Ереван, ул. Абеяна, 6/1, 4 этаж

Тел./Факс: + 374 (10) 398-667

E-mail: [erevan@dlink.ru](mailto:erevan@dlink.ru)

### Грузия

Тел./Факс: +995 (593) 98-3210

### Lietuva

09120, Vilnius, Žirmūnų 139-303

Tel./faks. +370 (5) 236-3629

E-mail: [info@dlink.lt](mailto:info@dlink.lt)

### Eesti

Mustamae 55-314

10621, Tallinn

Tel +372 613 9771

e-mail: [info@dlink.ee](mailto:info@dlink.ee)

### Latvija

Mazā nometņu 45/53 (ieeja no Nāras ielas)

LV-1002, Rīga

Tel.:+371 7 618-703

Fax: +371 7 618-706

e-pasts: [info@dlink.lv](mailto:info@dlink.lv)



## SOPORTE TÉCNICO

Usted puede encontrar actualizaciones de softwares o firmwares y documentación para usuarios a través de nuestro sitio [www.dlinkla.com](http://www.dlinkla.com)

### SOPORTE TÉCNICO PARA USUARIOS EN LATINO AMERICA

Soporte técnico a través de los siguientes teléfonos de D-Link

PAIS	NUMERO
Argentina	0800 - 12235465
Chile	800 260200
Colombia	01800 - 0180073
Costa Rica	0800 - 0521478
Ecuador	1800 - 035465
El Salvador	800 - 6335
Guatemala	1800 - 8350255
México	01800 - 0626270
Panamá	011 008000525465
Perú	0800 - 00968
Venezuela	0800 - 1005767

### Soporte Técnico de D-Link a través de Internet

Horario de atención Soporte Técnico en [www.dlinkla.com](http://www.dlinkla.com)

e-mail: [sosporte@dlinkla.com](mailto:sosporte@dlinkla.com) & [consultas@dlinkla.com](mailto:consultas@dlinkla.com)



## Suporte Técnico

Caso tenha dúvidas na instalação do produto, entre em contato com o Suporte Técnico D-Link.

Acesse o site: [www.dlink.com.br/suporte](http://www.dlink.com.br/suporte)



## D-Link 友訊科技 台灣分公司 技術支援資訊

如果您還有任何本使用手冊無法協助您解決的產品相關問題，台灣地區用戶可以透過我們的網站、電子郵件或電話等方式與D-Link台灣地區技術支援工程師聯絡。

**D-Link 免付費技術諮詢專線**

0800-002-615

手機付費電話 (02)6600-0123#8715

服務時間：週一至週五，早上9:00到晚上9:00

(不含周六、日及國定假日)

網 站：<http://www.dlink.com.tw>

電子郵件：[dssqa\\_service@dlink.com.tw](mailto:dssqa_service@dlink.com.tw)

如果您是台灣地區以外的用戶，請參考D-Link網站全球各地分公司的聯絡資訊以取得相關支援服務。

產品保固期限、台灣區維修據點查詢，請參考以下網頁說明：

<http://www.dlink.com.tw>

產品維修：

使用者可直接送至全省聯強直營維修站或請洽您的原購買經銷商。

**D-Link**<sup>®</sup>  
Building Networks for People

## **Dukungan Teknis**

Update perangkat lunak dan dokumentasi pengguna dapat diperoleh pada situs web D-Link.

### **Dukungan Teknis untuk pelanggan:**

#### **Dukungan Teknis D-Link melalui telepon:**

Tel: +62-21-5731610

#### **Dukungan Teknis D-Link melalui Internet:**

Email : [support@dlink.co.id](mailto:support@dlink.co.id)

Website : <http://support.dlink.co.id>



## Technical Support

この度は弊社製品をお買い上げいただき、誠にありがとうございます。

製品に同梱されている保証書の購入元にお問い合わせください。

**D-Link**<sup>®</sup>  
Building Networks for People

## 技术支持

办公地址：北京市朝阳区将台路5号院5号楼 邮编：100016

技术支持中心电话：400-629-6688

技术支持中心传真：(028)-61317620

各地维修中心地址请登陆官方网站查询

网址：<http://www.dlink.com.cn>

400电话工作时间：工作日9:00-19:00；节假日9:00-18:00.

**D-Link**<sup>®</sup>  
Building Networks for People

# Registration Card

## All Countries and Regions Excluding USA

*Print, type or use block letters.*

Your name: Mr./Ms \_\_\_\_\_

Organization: \_\_\_\_\_ Dept. \_\_\_\_\_

Your title at organization: \_\_\_\_\_

Telephone: \_\_\_\_\_ Fax: \_\_\_\_\_

Organization's full address: \_\_\_\_\_

\_\_\_\_\_

Country: \_\_\_\_\_

Date of purchase (Month/Day/Year): \_\_\_\_\_

Product Model	Product Serial No.	* Product installed in type of computer	* Product installed in computer serial No.

(\* Applies to adapters only)

*Product was purchased from:*

Reseller's name: \_\_\_\_\_

Telephone: \_\_\_\_\_

**Answers to the following questions help us to support your product:**

**1. Where and how will the product primarily be used?**

Home Office Travel Company Business Home Business Personal Use

**2. How many employees work at installation site?**

1 employee 2-9 10-49 50-99 100-499 500-999 1000 or more

**3. What network protocol(s) does your organization use ?**

XNS/IPX TCP/IP DECnet Others \_\_\_\_\_

**4. What network operating system(s) does your organization use ?**

D-Link LANsmart Novell NetWare NetWare Lite SCO Unix/Xenix PC NFS 3Com 3+Open Cisco Network  
Banyan Vines DECnet Pathwork Windows NT Windows 98 Windows 2000/ME Windows XP  
Others \_\_\_\_\_

**5. What network management program does your organization use ?**

D-View HP OpenView/Windows HP OpenView/Unix SunNet Manager Novell NMS  
NetView 6000 Others \_\_\_\_\_

**6. What network medium/media does your organization use ?**

Fiber-optics Thick coax Ethernet Thin coax Ethernet 10BASE-T UTP/STP  
100BASE-TX 1000BASE-T Wireless 802.11b and 802.11g wireless 802.11a Others \_\_\_\_\_

**7. What applications are used on your network?**

Desktop publishing Spreadsheet Word processing CAD/CAM  
Database management Accounting Others \_\_\_\_\_

**8. What category best describes your company?**

Aerospace Engineering Education Finance Hospital Legal Insurance/Real Estate Manufacturing  
Retail/Chain store/Wholesale Government Transportation/Utilities/Communication VAR  
System house/company Other \_\_\_\_\_

**9. Would you recommend your D-Link product to a friend?**

Yes No Don't know yet

**10. Your comments on this product?**

\_\_\_\_\_

\_\_\_\_\_

PLEASE  
PLACE STAMP  
HERE

**TO:**

---

---

---

**D-Link®**