

Eaton® Advanced Enclosure Power Distribution Unit (ePDU®)

User's Guide



Powering Business Worldwide

Eaton and ePDU are registered trademarks of Eaton Corporation or its subsidiaries and affiliates. Google Chrome is a trademark of Google, Inc. HyperTerminal is a registered trademark of Hilgraeve. Linux is a registered trademark of Linus Torvalds in the United States, other countries, or both. Microsoft, Internet Explorer, Vista, and Windows are registered trademarks of Microsoft Corporation in the United States and other countries. Mozilla and Firefox are registered trademarks of the Mozilla Foundation. National Electrical Code and NEC are registered trademarks of National Fire Protection Association, Inc. Phillips is a registered trademark of Phillips Screw Company. Torx is a registered trademark of Acument Intellectual Properties, LLC. All other trademarks are property of their respective companies.

©Copyright 2011–2012 Eaton Corporation, Raleigh NC, USA. All rights reserved. No part of this document may be reproduced in any way without the express written approval of Eaton Corporation.

Class A EMC Statements

FCC Information

This equipment has been tested and found to comply with the limits for a Class A digital device, pursuant to part 15 of the FCC Rules. These limits are designed to provide reasonable protection against harmful interference when the equipment is operated in a commercial environment. This equipment generates, uses and can radiate radio frequency energy and, if not installed and used in accordance with the instruction manual, may cause harmful interference to radio communications. Operation of this equipment in a residential area is likely to cause harmful interference in which case the user will be required to correct the interference at his own expense.

ICES-003

This Class A Interference Causing Equipment meets all requirements of the Canadian Interference Causing Equipment Regulations ICES-003.

Cet appareil numérique de la classe A respecte toutes les exigences du Règlement sur le matériel brouilleur du Canada.

Eaton is not responsible for damage to this product resulting from accident, disaster, misuse, abuse, non-Eaton modification of the product, or other events outside the reasonable control of Eaton or not arising under normal operating conditions.



Special Symbols

The following are examples of symbols used on the UPS or accessories to alert you to important information:



RISK OF ELECTRIC SHOCK - Observe the warning associated with the risk of electric shock symbol.



CAUTION: REFER TO OPERATOR'S MANUAL - Refer to your operator's manual for additional information, such as important operating and maintenance instructions.



This symbol indicates that you should not discard waste electrical or electronic equipment (WEEE) in the trash. For proper disposal, contact your local recycling/reuse or hazardous waste center.

Table of Contents

1	INTRODUCTION	1
	Description	1
	Eaton ePDU Models	1
	Accessories	5
	Environmental Monitoring Probe	5
	Cord Retention Bracket	6
	Features	6
	Ease of Use	6
	Communication	6
	Power Control Management	6
	Monitoring	6
	Configurability and Security	7
2	SAFETY WARNINGS	8
3	INSTALLATION	9
	Installation Precautions	9
	Inspecting the Equipment	9
	Installation Overview	10
	Tools Required	10
	Package Contents	10
	Installing the Optional Cord Retention Bracket	12
	Installing the ePDU in a Rack Cabinet	14
	Using Cage Nuts with Mounting Clip Feet	14
	Using Keyholes with Mounting Buttons	16
	Using Keyholes with Mounting Buttons and Clip Feet	18
	Grounding the ePDU	19
	Hardware Connectivity	20
	Connecting to a Computer Serial Port	20
	Connecting to a LAN Ethernet Port	22
	Installing an Optional EMP	23
	Connecting the Output Devices	24
	Equipment Setup Worksheet	25
4	NETWORK COMMUNICATION CONFIGURATION	26
	Enable the Network Management Card in Operation Mode	26
	IP Network Configuration	27
	Obtaining the IPv4 Address	28
	Retrieve the IPv4 Address	30
	Using the IPv4 Default Address Configuration	31
	Obtaining the IPv6 Address	31
	Networks That Allow Auto-Configuration	32
	Networks That Do Not Allow IPv6 Auto-Configuration	32
	Retrieve the IPv6 Address	33
	Verify Network Management Card Operation	34

5	OPERATION OVERVIEW	35
	Three-Phase Configurations	37
	Environmental Protection and Pin Alignment	37
	Outlet Groups Management	38
	Menu and Status Display	40
	LCD Window	40
	Operation Mode DIP Switches	42
	Restarting the Network Management Card	42
	Hardware Restart	42
	Software Restart	43
	LED Status Indicators	44
	Serial and Ethernet Connection Status	45
	Remote Interfaces	45
	Operation Concepts	46
	User Login and Access Policy	46
	Power Schedules for Managed and Switched ePDUs	50
	Group Definition	53
	Common Operation Tasks	53
	Download/Upload the Network Management Card File Configuration	53
	Download/Upload the ePDU File Configuration	53
	Clear ePDU and Event Log	54
	Refresh the Data Display	54
	SNMP Agent Overview	54
	Actions on Individual Outlets and Groups of Outlets	55
	Restart the Network Management Card	56
	Restore the Default Factory Settings of the Network Management Card	56
	Settings	56
	Modify Settings	56
	Network Management Card Settings Table	57
	ePDU Settings Table	64
	Starting the ePDU	67
	Shutting Down the ePDU	67
6	LCD OPERATION	68
	LCD Panel and Control Buttons	68
	Operation Mode	68
	Screensaver Cycling Sequence	69
	Locked Screen	71
	Lock 1 and Lock 2 Passwords	72
	Startup Screen	72
	Main Menu Selections	72
	Active Alarms Menu	74
	Event Log Menu	75
	Outlet Readings Menu	75
	Settings Menu	76
	ePDU Info Menu	78

7	WEB INTERFACE OPERATION	79
	Navigating the Web Interface	79
	Accessing the Web Interface	81
	Menu Selections	82
	Power Management	82
	Logs & Notifications	83
	Settings	83
	ePDU Overview	83
	Review/Modify ePDU Data	83
	Configure Environment Sensor Settings	84
	ePDU Groups	84
	Review/Modify ePDU Groups	85
	ePDU Outlets	85
	Review/Modify ePDU Outlets	85
	Power Schedule	86
	Define a Power Schedule	86
	Active Alarms	87
	Review Active Alarms	87
	Logs	88
	Clear the Event Log	88
	Download the Event Log as a Comma Separated Value File	88
	Email Notification	88
	Configure the Email Receivers	88
	Trap Notification	89
	Define the Trap Receivers	89
	Group Definition	90
	Configure an Outlet Group	90
	Access Control	91
	Configure the Superuser	91
	Configure Multi-Users	91
	Enable/Disable SSL Encryption	92
	Enable/Disable the Telnet Interface	92
	Network	92
	Configure the Ethernet Link Speed and Duplex Mode	92
	Configure the IPv4 Settings	93
	Configure the IPv6 Settings	93
	System	94
	Enable/Disable Firmware Upgrade	94
	Network Management Card Maintenance	95
	Network Management Card Configuration	95
	ePDU Configuration	95
	SNMP	96
	Enable/Disable the SNMP Agent	96
	Define SNMPv1 Users	96
	Define SNMPv3 User-based Security Model Users	96
	SNMP & DNS	97
	Configure the DNS	97
	Configure the SMTP	97

Date & Time	97
Manually Configure the Date and Time	97
Automatically Configure the Date and Time	98
8 SERIAL INTERFACE OPERATION	99
Navigating the Serial Interface	99
Connecting the Equipment	99
Accessing the Interface	100
Selecting a Configuration Menu	100
Network Management Card Information	101
Network Settings	101
IPv4 Configuration	101
IPv6 Configuration	102
Communication Control	103
Hostname	107
Primary and Secondary DNS IP Address	108
Trap Receivers	109
SNMP v1 Community	109
SNMP V3 USM Table	110
Modify a Table Entry	110
Restore Factory Defaults	111
Date and Time	112
Manually Configure the Date and Time	112
Configure the Date and Time Automatically	112
Email Notifications	113
Configure Email Notifications	113
Configure the Email Receivers	114
Test Email	116
Superuser Name and Password	116
Multi-Users	117
EnergyWise Settings	118
9 MAINTENANCE AND TROUBLESHOOTING	120
Preventive Maintenance	120
Equipment Disposal	120
Network Management Card Firmware Upgrade	120
Enable Firmware Upgrade Mode	121
Web Interface	121
Serial Interface	122
DIP Switch Configuration	123
Upload New Firmware Files	123
Restart the Network Management Card	127
Troubleshooting	127
Acknowledging the Alarm	127
Types of Alarms	128
Alarms, Notices, and Events	128
Events	131

10	SPECIFICATIONS	133
	Model List	133
	Weights and Dimensions	134
	Electrical Input and Output	135
	Electrical Ratings	136
	Overcurrent Protection	137
	Environmental and Safety	137
11	SERVICE AND SUPPORT	139
	Ordering Optional and Spare Parts	139

Chapter 1 Introduction

Description

The Eaton® Advanced Enclosure Power Distribution Unit (ePDU®) is an intelligent ePDU that is designed to distribute power within a standard 19" rack. A wide range of models let you connect and manage C13 and C19 outlets from a single power connection with monitoring or switching capabilities, or both.

The monitoring or switching capabilities are characterized as follows:

- Advanced Monitored (AM) with individual outlet monitoring but no outlet control
- Switched (SW) with control of outlets but no individual outlet monitoring
- Managed (MA) with control and monitoring at the outlet level

These capabilities are expressed in the model numbers of the ePDUs.

Eaton ePDU Models

There are 28 Eaton Advanced ePDU models. These models are categorized into eight model types defined primarily by the input and outlet configurations. The Advanced ePDU models support single-phase or three-phase applications and can manage up to 24 outlets. All models feature an LCD window, LEDs to indicate outlet status, and a set of communication connectors. The Advanced ePDUs have either attached or detached input power cords and some models have circuit breakers.



NOTE

For details about individual model configurations, see Chapter 10, "Specifications" on page 133.

Figure 1 shows an example of the Type 1 ePDU.

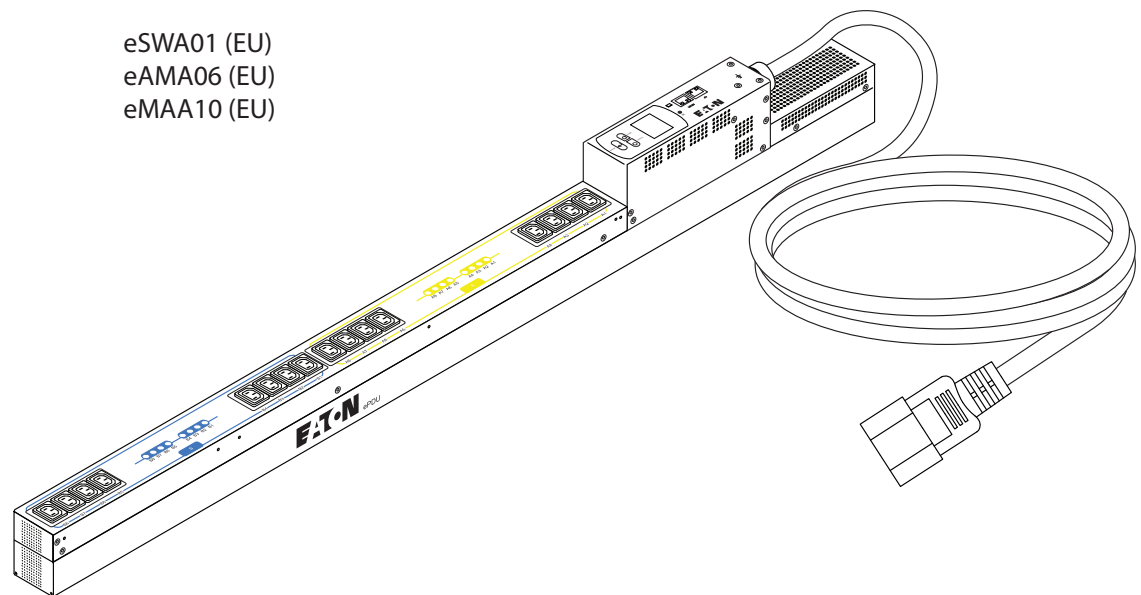

Figure 1. Type 1 Single-Phase Model (eSWA01 Switched Model Shown)

Figure 2 shows an example of the Type 2 ePDU.

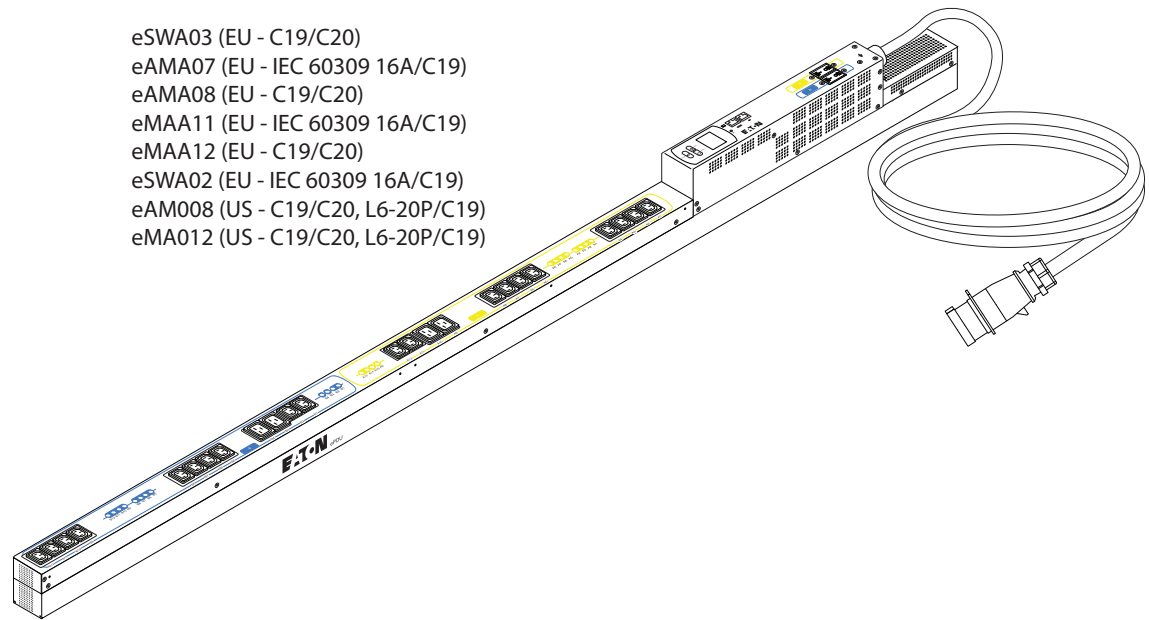

Figure 2. Type 2 Single-Phase Model with Detachable Power Cord (eSWA03 Switched Model Shown)

Figure 3 shows an example of the Type 3 ePDU.

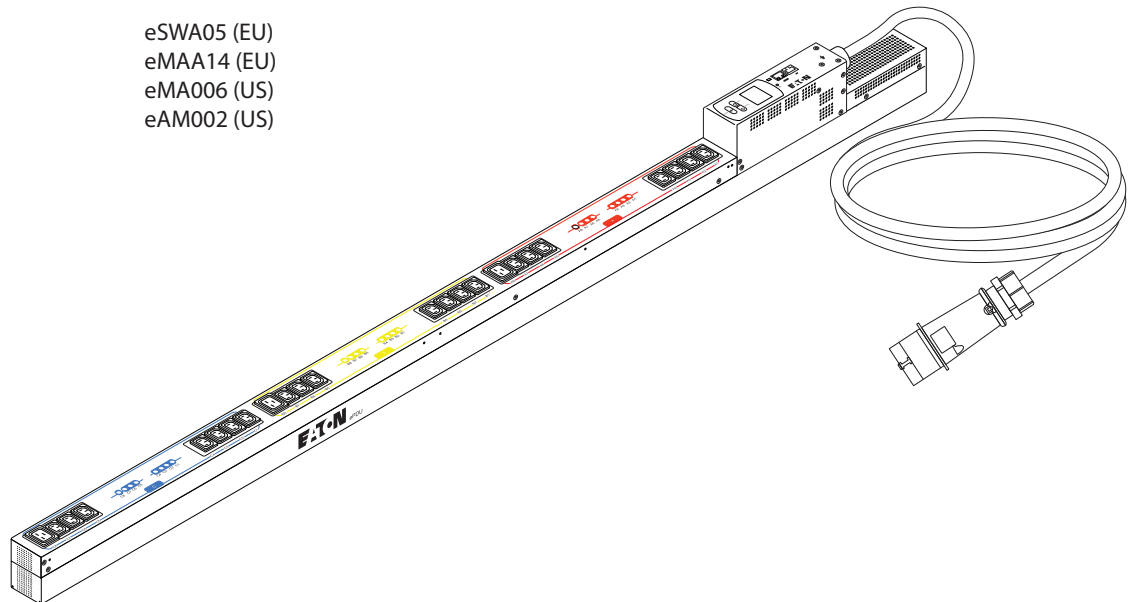

Figure 3. Type 3 Three-Phase Model (eSWA05 Switched Model Shown)

Figure 4 shows an example of the Type 4 ePDU.

eMAA13 (EU)
eSWA04 (EU)
eAMA09 (EU)

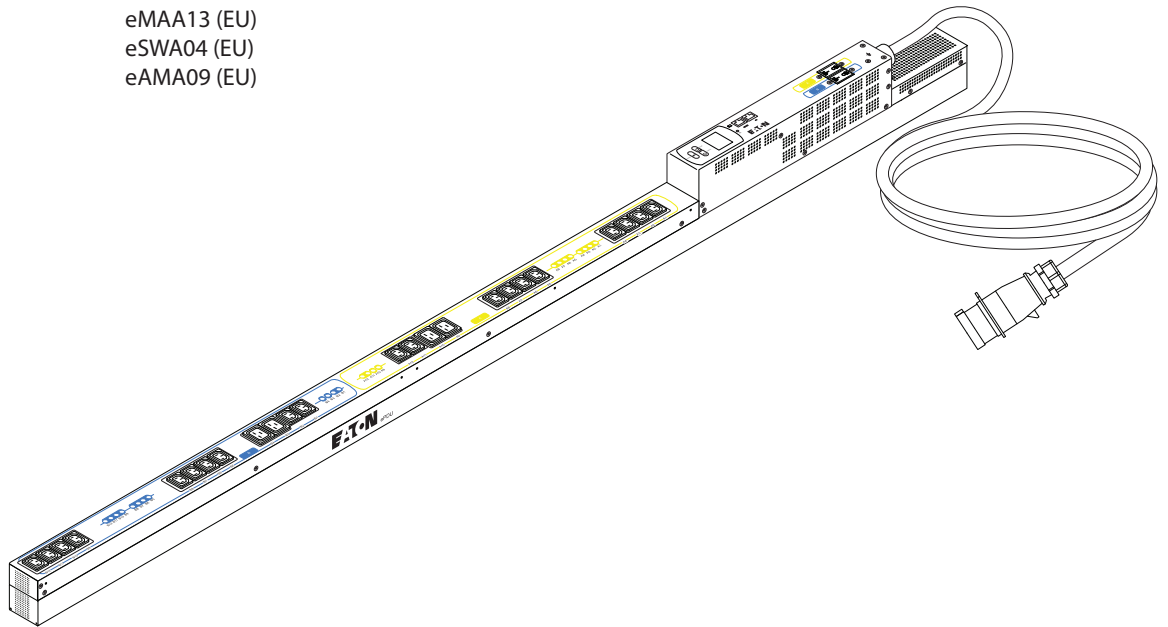

Figure 4. Type 4 Single-Phase Model (eMAA13 Managed Model Shown)

Figure 5 shows an example of the Type 5 ePDU.

eAM001 (US)
eMA010 (US)

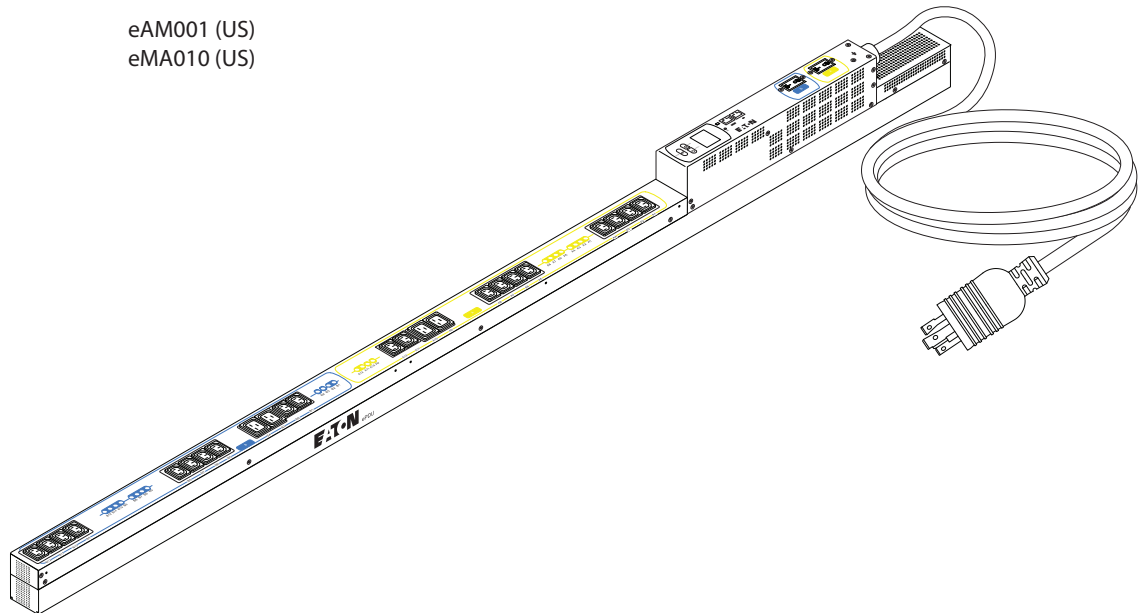

Figure 5. Type 5 Single-Phase Model (eAM001 Advanced Monitored Model Shown)

Figure 6 shows an example of the Type 6 ePDU.

- eMA007 (US)
- eAM003 (US)
- eAM004 (US)
- eMA011 (US)

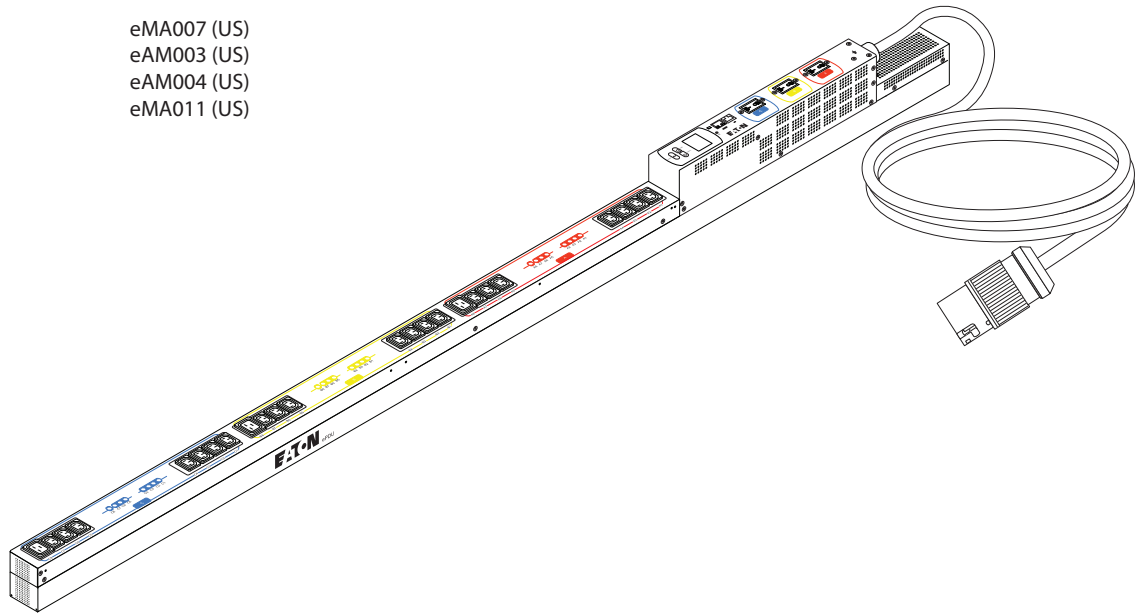

Figure 6. Type 6 Three-Phase Model (eMA007 Managed Model Shown)

Figure 7 shows an example of the Type 7 ePDU.

- eMA013 (US)

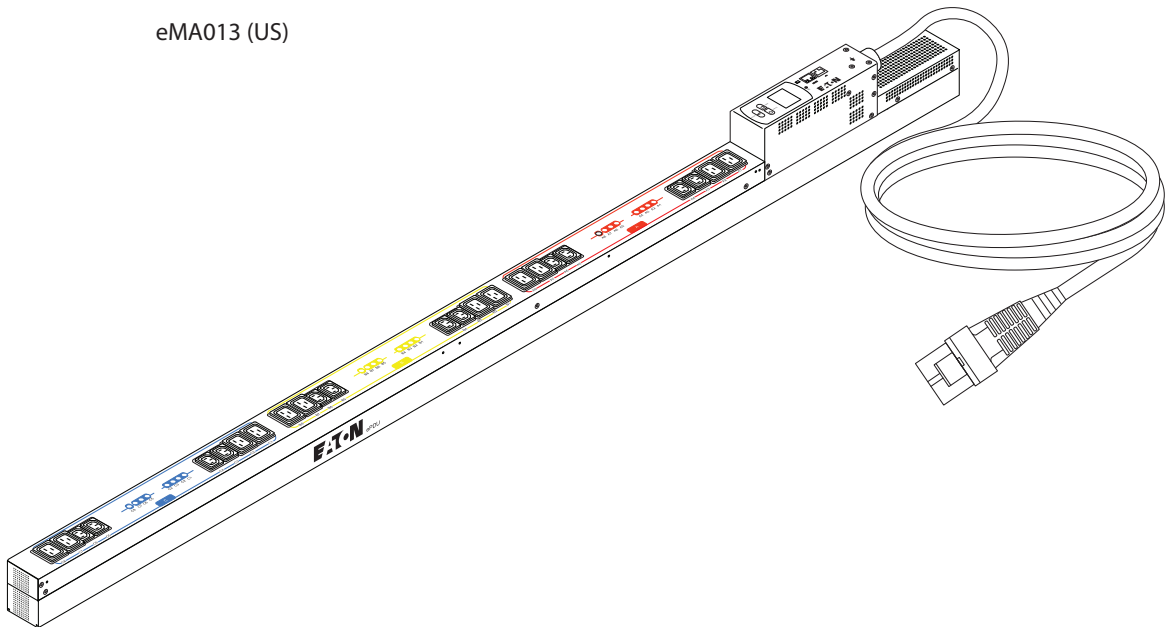

Figure 7. Type 7 Three-Phase Model (eMA013 Managed Model Shown)

Figure 8 shows an example of the Type 8 ePDU.

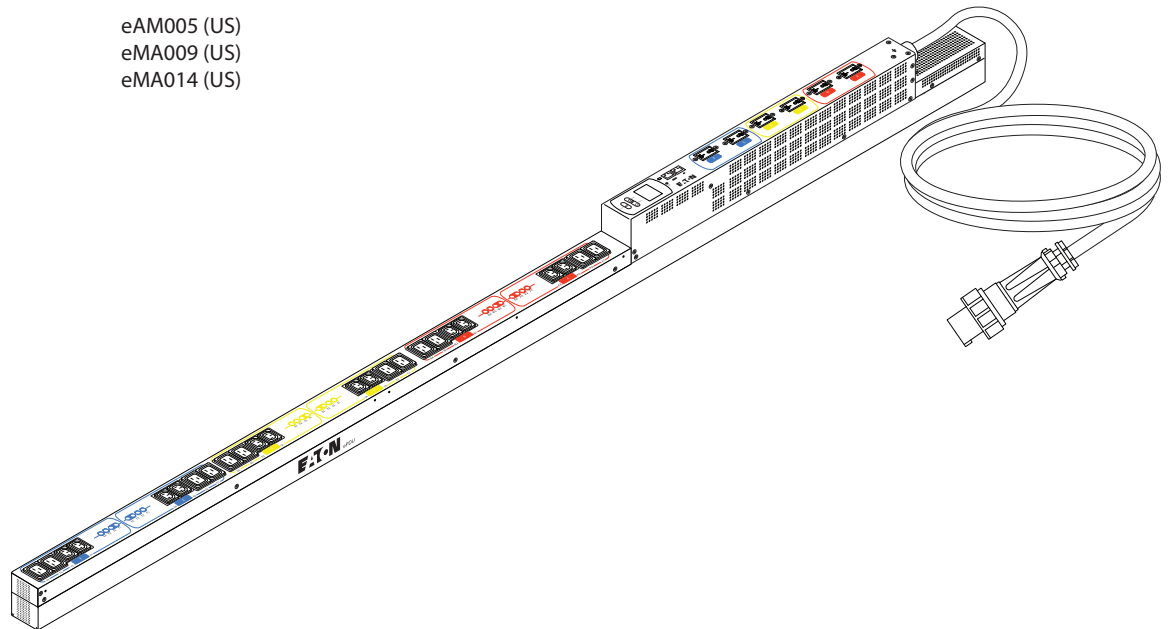

Figure 8. Type 8 Three-Phase Model (eAM005 Advanced Monitored Model Shown)

Accessories

The following accessories are optional and must be purchased separately.

Environmental Monitoring Probe

The optional Environmental Monitoring Probe (EMP) provides monitoring of external temperature, humidity, and the status of two contact devices, providing greater power management control and flexible monitoring. The EMP has the following features:

- Simplified installation lets you install the EMP safely without turning off power to the ePDU or to the devices that are connected to it.
- The EMP monitors temperature and humidity information of any environment, protecting your critical equipment. The EMP measures temperatures between 0°C and 80°C (32°F and 176°F) with an accuracy of $\pm 1^\circ\text{C}$. The EMP measures relative humidity between 10% and 90% with an accuracy of $\pm 5\%$.
- The EMP can be located away from the ePDU with a Category 5 network cable up to 20m (65.6 ft) long.
- The EMP monitors the status of two user-supplied contact devices.
- Temperature, humidity, and contact closure status can be displayed through a variety of interfaces.
- User-selectable alarm thresholds let you define acceptable temperature or humidity limits.
- You can use e-mail client software to set up e-mail notification through Simple Mail Transfer Protocol (SMTP) when acceptable alarm limits are exceeded or contact status changes.
- Changes in external contact status are logged in the ePDU event history log.
- When temperature and humidity values exceed user-selectable limits, the event is logged in the ePDU event history log.

Cord Retention Bracket

The Cord Retention Bracket kit includes brackets, cable ties, and mounting hardware. Attach the brackets to your ePDU to help you manage and secure the power cords of the devices you connect to the ePDU.

**NOTE**

For information updates, refer to the Eaton ePDU catalog or go to www.eaton.com/ePDU.

Features

The Eaton Advanced ePDU provides outstanding performance and reliability, including the following unique benefits:

Ease of Use

- Easy and flexible rack installation
- Easy-to-use interface to display input and output status
- Color-coded outlets and circuit breakers for easy correlation
- A visual alarm (blinking LED) to indicate outlet current overload
- User-friendly firmware updates

Communication

- Comprehensive power management and flexible configuration through a Web browser or a serial connection, a Telnet connection, Simple Network Management Protocol (SNMP), or a console emulator such as HyperTerminal®
- Compatibility with network management tools such as Intelligent Power Manager (IPM), facilitated by SNMP protocol

Power Control Management

- Control of outlets for Switched or Managed ePDUs, both collectively and individually
- The ability to power on, power off, and reboot the devices connected to each outlet
- Fully shrouded local branch circuit breakers on products rated over 16A (Europe) / 20A (US) to protect connected equipment against overload and short circuits
- Configuring and monitoring the power schedule of outlets
- Configuring collocated users as a user group with restricted access to user-defined outlet groups

Monitoring

- Monitoring of the following at the outlet level:
 - Root Mean Square (RMS) current
 - Power factor
 - Maximum and minimum thresholds for current or voltage
 - RMS voltage
 - Active power
 - Apparent power

- Monitoring of internal CPU temperature
- Monitoring of the ePDU locally or remotely through a console or network
- Remote monitoring of connected devices and sensors
- Daily history report through e-mail
- Detailed data-logging for statistical analysis and diagnostics
- Dual color LCD for higher visibility on local alarms

Configurability and Security

- Configurable alarm thresholds
- Configurable user access control through collocation
- Address-specific IP security mask to prevent unauthorized access

Chapter 2 Safety Warnings

IMPORTANT SAFETY INSTRUCTIONS — SAVE THESE INSTRUCTIONS

This manual contains important instructions that you should follow during installation and operation of the Eaton Advanced Enclosure Power Distribution Unit (ePDU). Please read all instructions before operating the equipment and save this manual for future reference.

DANGER

This ePDU contains **LETHAL VOLTAGES**. All repairs and service should be performed by **AUTHORIZED SERVICE PERSONNEL ONLY**. There are **NO USER SERVICEABLE PARTS** inside the ePDU. **SYSTEMS SHOULD ONLY BE INSTALLED, TESTED, AND CONFIGURED BY A COMPETENT PERSON. IT IS ESSENTIAL THAT THIS EQUIPMENT IS CONNECTED TO AN ELECTRICAL SUPPLY THAT HAS PROTECTIVE GROUND CONDUCTOR.**

CAUTION

- To reduce the risk of fire or electric shock, install this ePDU in a temperature and humidity controlled, indoor environment, free of conductive contaminants. Ambient temperature must not exceed 50°C (122°F). Do not operate near water or excessive humidity (90% maximum).
 - Do not use a two-wire power cord in any product configuration.
 - Test AC outlets at your computer and monitor for proper polarity and grounding.
 - Use only with grounded outlets at both the computer and monitor. When using a backup UPS, power the computer, monitor, and appliance off the supply.
 - The installation power outlet used for the power supply to this equipment must be installed near the equipment and must be easily accessible.
 - When installing this product, it is essential that the distribution circuit supplying the product is protected by a branch circuit protection device with a maximum rating to suit the product maximum rating.
 - TO ISOLATE THIS EQUIPMENT, DISCONNECT THE POWER SUPPLY PLUG.
 - This power distribution unit is intended for providing power to equipment only. Secondary (satellite) power strips shall not be connected to the outlets.
 - This product has been designed to conform to the latest safety requirements. In addition to compliance with standards for general use, it has been factory configured for use in rack mounting environments, aiding the installer to provide systems compliant with relevant standards.
-

CAUTION

This product contains a lithium battery on the internal Network Management Card:

- The battery is not user-replaceable. However, there is risk of explosion if battery is replaced by an incorrect type.
 - The battery is not user-replaceable. However, ensure that used batteries are disposed of according to the instructions. For more information, contact your local recycling/reuse or hazardous waste center for proper disposal information.
-

Chapter 3 Installation

All Eaton Advanced Enclosure Power Distribution Unit (ePDU) models are 0U products and are mounted vertically inside standard rack structures. Use the information in this chapter to prepare, install, and connect the ePDU and optional accessories.

Installation Precautions

Before you install or connect the ePDU in a rack cabinet, observe the following precautions:

- Only a competent service person should install, test, or configure the ePDU and its optional accessories. It is the installer's responsibility to ensure that the selected product is installed to meet national and local safety regulations.
- Read and understand all warnings and cautions listed in Chapter 2, "Safety Warnings" on page 8.
- Review the documentation that comes with your rack cabinet for safety and cabling information.

**NOTE**

Removing the rack cabinet doors and side panels might make installation easier. See the rack cabinet documentation for more information.

-
- Verify that the room air temperature is below 50°C (122°F).
 - Take all necessary precautions to handle the weight of the devices.
 - Connect all power cords to properly wired and grounded electrical outlets.
 - Verify that the power outlet is near the equipment and is easily accessible so that the ePDU can be disconnected quickly.
 - Do not overload the power outlet when you install multiple devices in the rack cabinet.
 - To reduce the risk of fire, connect only to a circuit provided with branch circuit overcurrent protection with an ampere (A) rating in accordance with the National Electrical Code® (NEC®), ANSI/NFPA 70 or your local electrical code, as listed in Table 26 on page 137.
 - Verify that all equipment is unplugged from ePDU outlets before carrying out any testing.

**NOTE**

The illustrations in this document might differ slightly from your hardware.

Inspecting the Equipment

If any equipment has been damaged during shipment, keep the shipping cartons and packing materials for the carrier or place of purchase, and file a claim for shipping damage. If you discover damage after acceptance, file a claim for concealed damage.

To file a claim for shipping damage or concealed damage: 1) File with the carrier within 15 days of receipt of the equipment; 2) Send a copy of the damage claim within 15 days to your service representative.

Installation Overview

The installation instructions describe how to install the ePDU vertically in a standard rack. You can choose one of three installation methods. This manual also describes how to install optional accessories, connect the ePDU to a communication network, become familiar with ePDU operation, and care for the ePDU.



NOTE 1 Power cords for the devices that you connect to the ePDU are not included.

NOTE 2 Some parts may not be used, depending on your choice of installation method.

Tools Required

The following tools are needed to install the ePDU in a rack cabinet:

- One flat-blade screwdriver
- One Phillips® screwdriver
- One 10 mm (11/32") star wrench (Torx®)
- One cage nut insertion tool or flat-blade screwdriver (for installing cage nuts in some rack cabinets)

Package Contents

Table 1 lists the parts that are included with Advanced ePDU models. Table 2 on page 12 lists the detachable ePDU power cords included with some Advanced ePDU models. See Table 30 on page 139 for a list of Eaton catalog part numbers for ordering optional and spare parts for the ePDU.

Table 1. Parts Included with All Eaton Advanced ePDU Models

Quantity	Description	
1	<i>Eaton Advanced ePDU Quick Start for Installation and Connectivity</i> (P-164000041) NOTE Supplied in the shipping carton and also available at www.eaton.com/ePDU .	
1	<i>Eaton Advanced ePDU Quick Start for Network Communication Management</i> (P-164000060) NOTE Supplied in the shipping carton and also available at www.eaton.com/ePDU .	
2	Plastic mounting clip feet *	

Table 1. Parts Included with All Eaton Advanced ePDU Models (Continued)



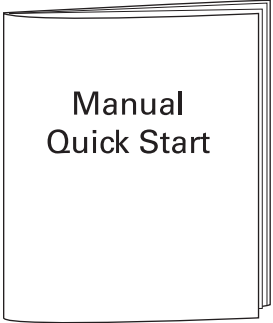
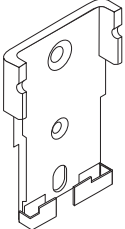

Quantity	Description	
2	Anti-sliding safety screw *	
2	Cage nut **	
2	Screw for mounting clip feet and cage nut assembly **	
2	Screw for keyhole mounting button ***	
2	Hex nut for keyhole mounting button ***	
2	Keyhole mounting button ***	

Table 1. Parts Included with All Eaton Advanced ePDU Models (Continued)

Quantity	Description
1	Serial cable, DB9-to-RJ-45 ****
	
1	Ethernet cable *****
	

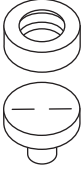
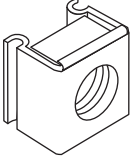
* The plastic mounting clip feet and the anti-sliding safety screw are packaged together in a large, clear shipping bag with two smaller bags. These parts are shipped in the carton with the ePDU.

** The cage nut and the screw for the clip feet and the cage nut are packaged together in a small, clear shipping bag within a larger bag. These parts are shipped in the carton with the ePDU.

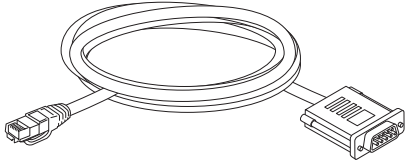
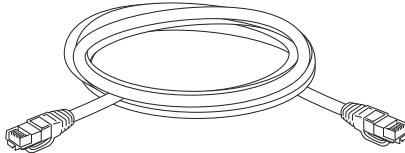
*** The keyhole mounting button, screw, and nut are packaged together in a small, clear shipping bag within a larger bag. These parts are shipped in the carton with the ePDU.

**** The serial cable is located on the left of the shipping carton, just below the middle Styrofoam packing block that stabilizes the ePDU during transport.

***** The Ethernet cable is intended for customers with small data centers, for maintenance, or for checks in a warehouse setting. Larger data center customers may choose to use their own network cable.

***** Do not confuse this cable with the Ethernet cable that is used to connect the EMP. That cable is packaged in the EMP shipping carton with the EMP and accessory kit.

NOTE The *Eaton Advanced ePDU User's Guide* (P-164000042) PDF version is available at www.eaton.com/ePDU.

Table 2. Accessory (Detachable) Power Cords

Quantity	Description
1	Detachable input power cord C20/C19 Models: eSWA03, eAMA08, eMAA12, eAM008, eMA012
1	Detachable input power cord L6-20P/C19 Models: eAM008, eMA012
1	Detachable input power cord IEC 60309 16A/C19 Models: eSWA02, eAMA07, eMAA11

NOTE Detachable input power cords are shipped in the carton with the appropriate ePDU model.

Installing the Optional Cord Retention Bracket



NOTE Depending on your installation, you can add or remove cord retention brackets after the ePDU is installed in the rack cabinet.

If you ordered the optional Cord Retention Bracket Kit, install the brackets onto the ePDU as follows:

1. Locate the cord retention brackets and cable ties.
2. Using the screws and a Phillips screwdriver, attach the brackets in a configuration appropriate for your ePDU model and your installation needs. See the examples shown in Figure 9.

⚡ DANGER

Electrical Hazard: To avoid shock or possible equipment damage, use only the supplied screws when installing the cord retention brackets.

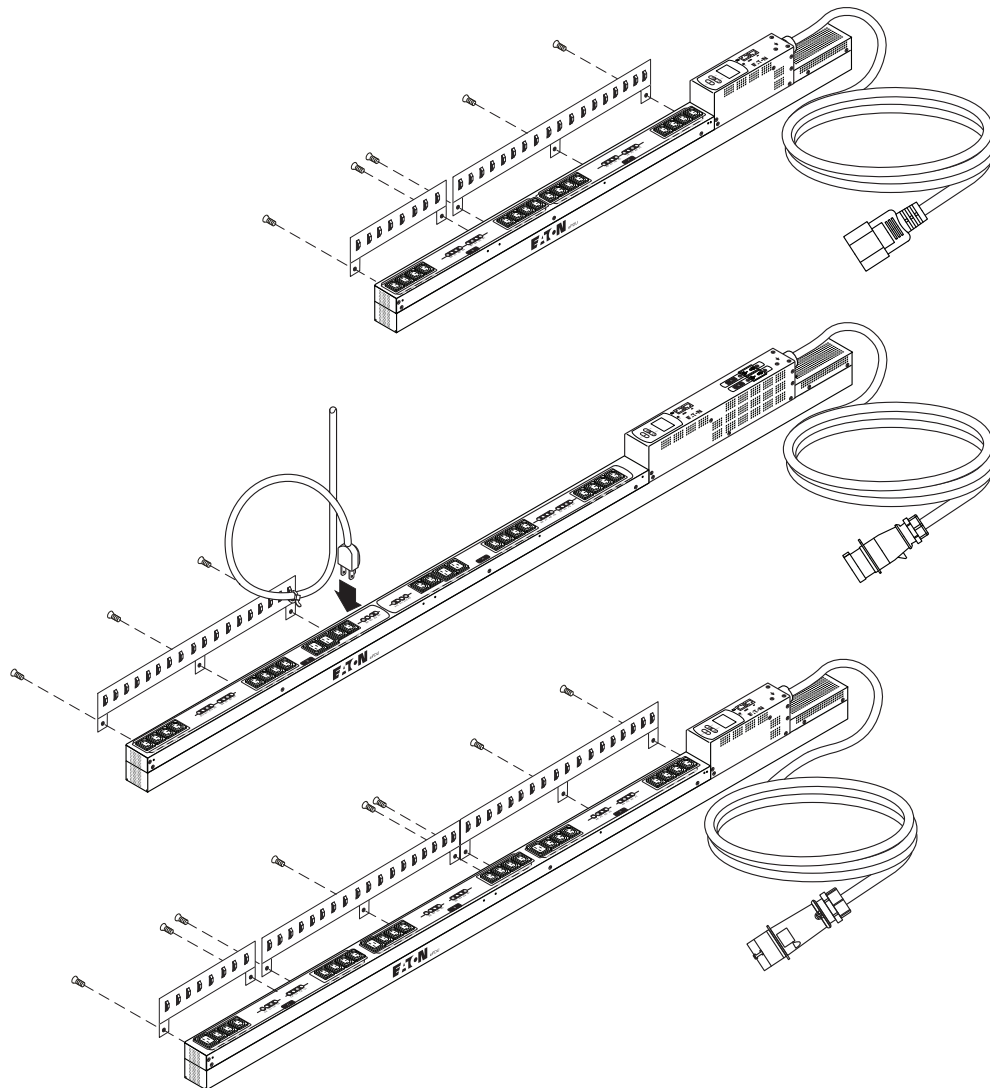

Figure 9. Installing the Cord Retention Brackets

3. Retain the cable ties for later use with the installed devices.

Installing the ePDU in a Rack Cabinet

There are three methods available for installing the ePDU in a rack cabinet. Review the installation methods described in this section and choose the method appropriate for your environment.

Using Cage Nuts with Mounting Clip Feet

To install the ePDU with mounting clip feet secured by cage nuts:

1. Locate the two cage nuts (supplied). Position and lock the two cage nuts far enough apart to stabilize the top and bottom of the ePDU when mounted on the rail. Attach the cage nuts with a flat-blade screwdriver.
2. Locate the two mounting clip feet and two screws (supplied). Position one mounting clip foot at a cage nut and secure the mounting clip foot to the rail with a screw, as shown in Figure 10. Repeat for the second mounting clip. Tighten both screws.



NOTE You can install the mounting clip feet vertically or horizontally.

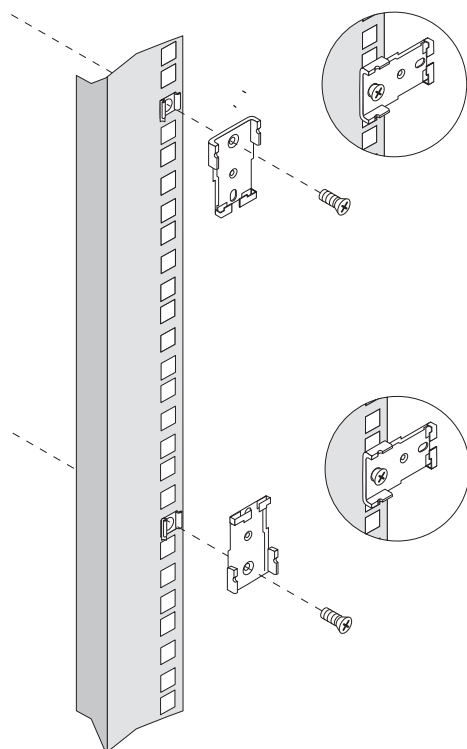

Figure 10. Attaching the Mounting Clip Feet



NOTE Use great care in handling the ePDU in the following steps. Avoid contact between the ePDU and the rack.

3. Locate the anti-sliding safety screw (supplied). Choose the tapped hole on the rear of the ePDU that is just above the topmost mounting clip on the ePDU. Attach the screw to the ePDU and tighten the screw firmly.
4. Snap the ePDU into the mounting clip feet. When you hear a clicking sound for each mounting clip foot, the ePDU is secure.
5. Carefully move the ePDU into position against the rail, verifying that the anti-sliding safety screw is above the topmost mounting clip.
6. Snap the ePDU into the rail, as shown in Figure 11. When you hear a clicking sound for each mounting clip, the ePDU is secure.

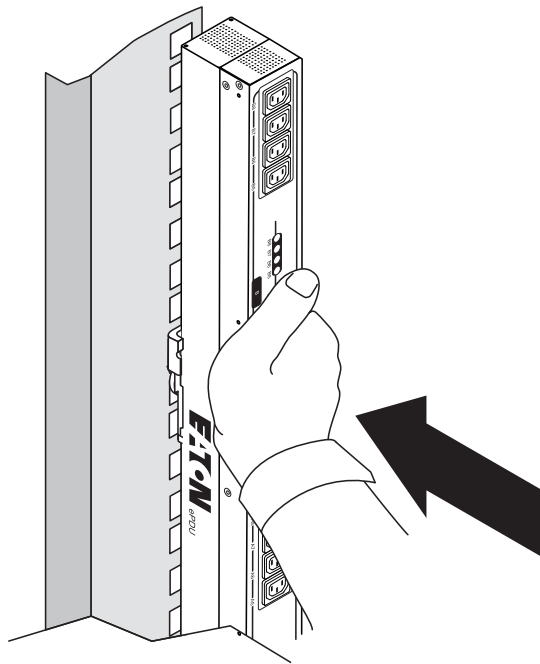

Figure 11. Attaching the ePDU to the Rail

Using Keyholes with Mounting Buttons



NOTE The anti-sliding safety screw is not required for this installation method.

To install the ePDU with mounting buttons directly attached to the ePDU:

1. Locate the two mounting buttons and installation screws (supplied).
2. Using the supplied screws and a Phillips screwdriver, install the mounting buttons on the ePDU far enough apart to stabilize the ePDU when mounted on the rail. See Figure 12.

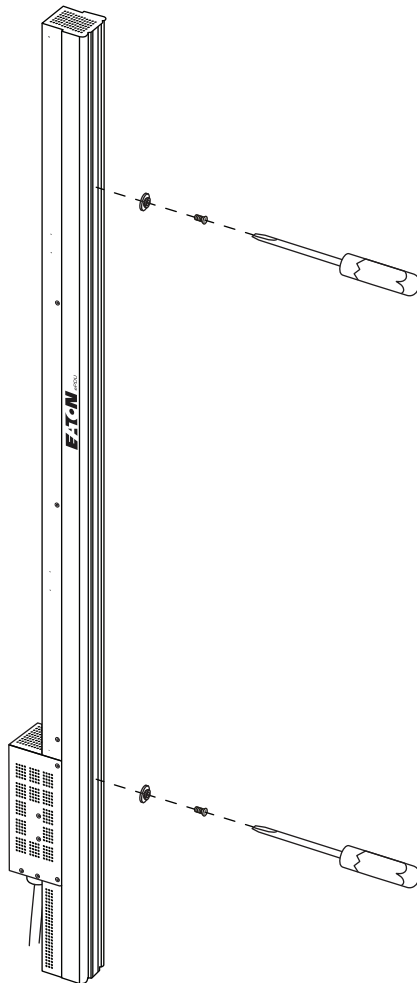

Figure 12. Installing the Mounting Buttons



NOTE Use great care in handling the ePDU in the following steps. Avoid contact between the ePDU and the rack.

3. Carefully move the ePDU into position against the rail.

4. Insert the top and bottom mounting buttons into the appropriate keyhole slots, as shown in Figure 13.

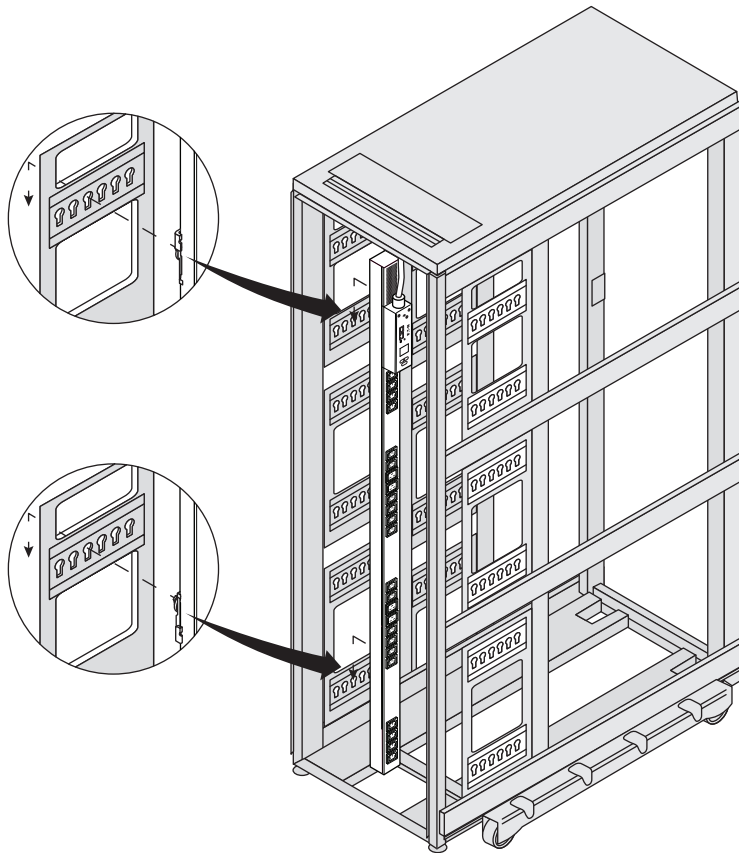

Figure 13. Securing the ePDU

5. Push down to secure the ePDU in position.

Using Keyholes with Mounting Buttons and Clip Feet

To install the ePDU with mounting buttons installed on the mounting clip feet:

1. Locate the two mounting clip feet, mounting buttons, screws, and hex nuts (supplied). Using a Phillips screwdriver, assemble the mounting buttons and clip feet (see Figure 14).

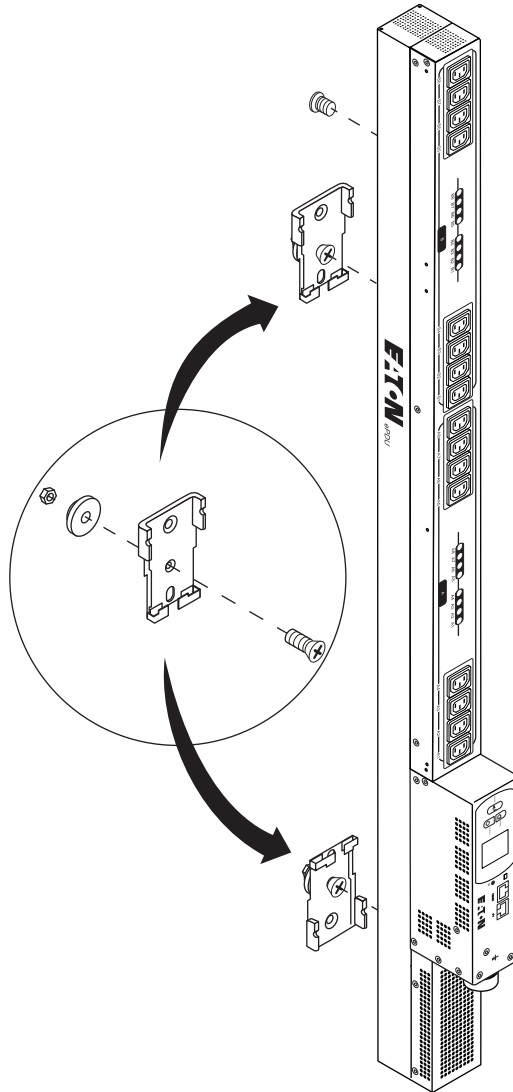

Figure 14. Attaching the Mounting Buttons to the Mounting Clip Feet



NOTE Use great care in handling the ePDU in the following steps. Avoid contact between the ePDU and the rack.

2. Snap the two clip assemblies onto the ePDU far enough apart to stabilize the top and bottom of the ePDU when mounted on the rail and to match one of the keyhole distances on the rack.
3. Locate the anti-sliding safety screw (supplied). Choose the tapped hole on the rear of the ePDU that is just above the topmost mounting clip on the ePDU. Attach the screw to the ePDU and tighten the screw firmly.
4. Carefully move the ePDU into position against the rail, verifying that the anti-sliding safety screw is above the topmost mounting clip (see Figure 14 on page 18).
5. Insert the top and bottom mounting buttons into the appropriate keyhole slots.
6. Push down to secure the ePDU in position.

Grounding the ePDU



NOTE Grounding the ePDU is optional but recommended.

To ground the ePDU, connect a grounding cable (not supplied) from earth to the grounding screw shown in Figure 15.

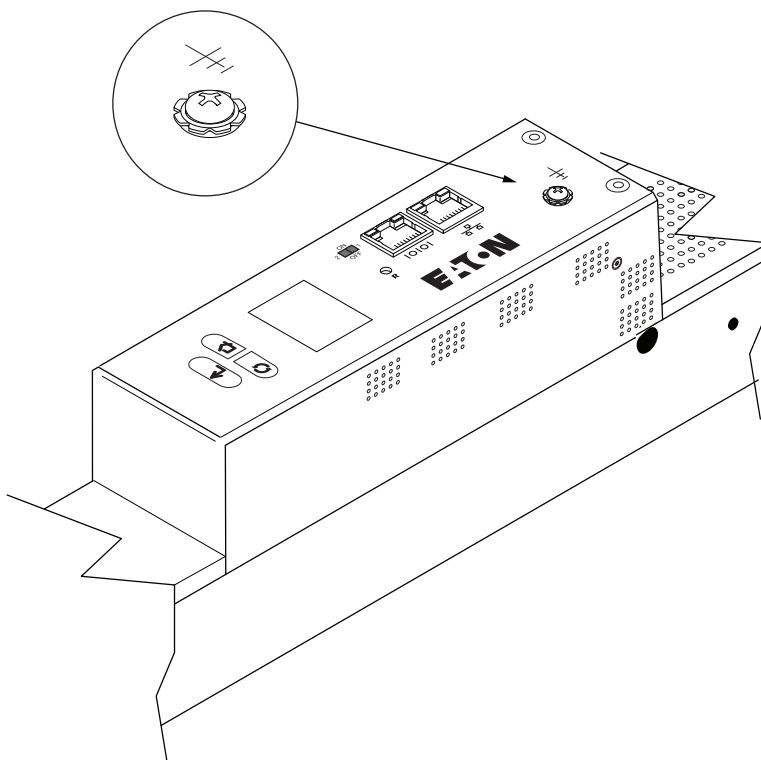

Figure 15. Grounding Screw Location

Hardware Connectivity

The ePDU provides a serial and an Ethernet port for network connectivity.

- To connect the ePDU to a serial port on a computer, go to the next section, “Connecting to a Computer Serial Port.”
- To connect the ePDU to an Ethernet port and the LAN, go to “Connecting to a LAN Ethernet Port” on page 22.

Connecting to a Computer Serial Port

Connecting the ePDU to a computer allows communication through a serial connection.

To connect the ePDU to a computer:

1. Verify that the computer has a communication program such as HyperTerminal or PuTTY.

NOTE About HyperTerminal and PuTTY console emulator programs:



- HyperTerminal is available on many Windows® operating systems. But HyperTerminal is not available on the Windows Vista® operating system.
- PuTTY is a free program you can download from the Internet. Refer to PuTTY product documentation for details on configuration.



IMPORTANT

You must use the supplied DB9-to-RJ-45 cable (PN 720-B1817-00). Do not use a substitute cable.

2. Locate the DB9-to-RJ-45 cable (supplied).
3. Connect the RJ-45 end of the cable to the RS-232 connector on the ePDU. Connect the DB9 end of the cable to the serial connector on the computer. See Figure 16.

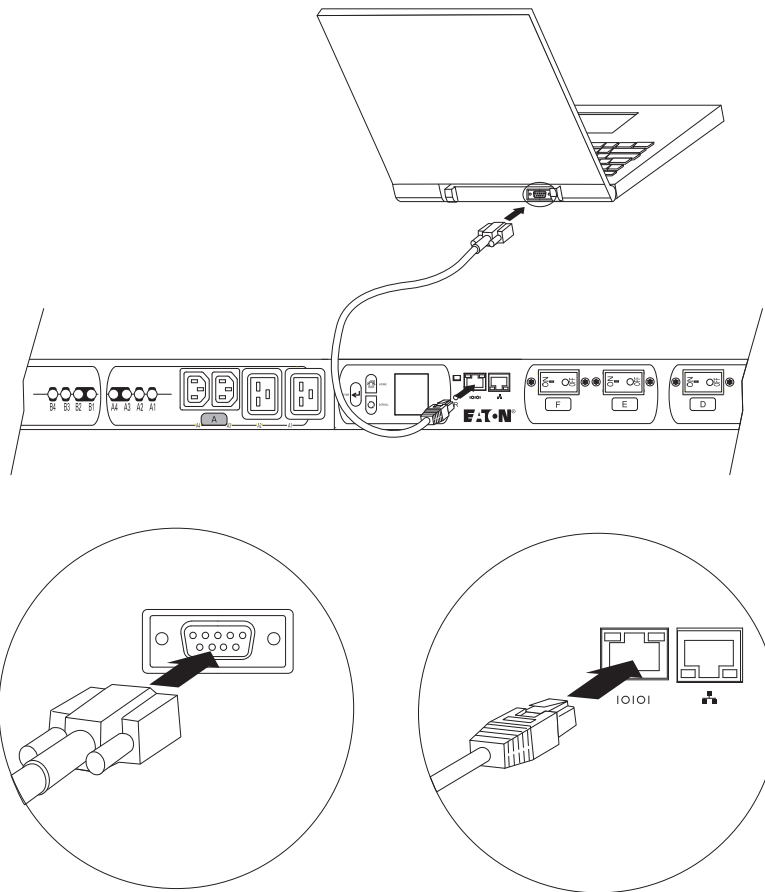

Figure 16. Connecting to a Computer Serial Port



NOTE

If your computer does not have a DB9 serial connector, but does have a USB connector, obtain a DB9-to-USB converter cable. Follow the manufacturer's instructions to install the converter cable device drivers and to connect the converter cable to your computer.

4. Open the communication program on the computer and select the serial port connection (such as COM1).
5. Verify that the port settings are configured as follows:
 - Baud rate (bits per second) = 9600
 - Data bits = 8
 - Stop bits = 1
 - Parity = None
 - Flow control = None
6. Verify that the ePDU is turned on.
7. Verify that DIP **Switch 1/OFF** and **Switch 2/OFF** (default).

- Press [Enter] to display the opening configuration prompt and type **admin** (the access password).



NOTE See “Serial Interface Operation” on page 99 for more information about configuring and monitoring the ePDU.

Connecting to a LAN Ethernet Port

Connecting the ePDU to a Local Area Network (LAN) provides communication through an Internet or Intranet connection. You can monitor the ePDU from any computer connected to the same network. To connect the ePDU to a LAN:

- Obtain an Ethernet cable.



NOTE A short Ethernet cable is supplied in the ePDU shipping carton. This cable is useful in a small data center for maintenance or for checks in a warehouse setting. Larger data center customers may choose to use their own network cable.

- Connect one end of the cable to the Ethernet connector on the ePDU. Connect the other end of the cable to the Ethernet connector on the router (or other LAN device). See Figure 17.



NOTE See “Web Interface Operation” on page 79 for more information.

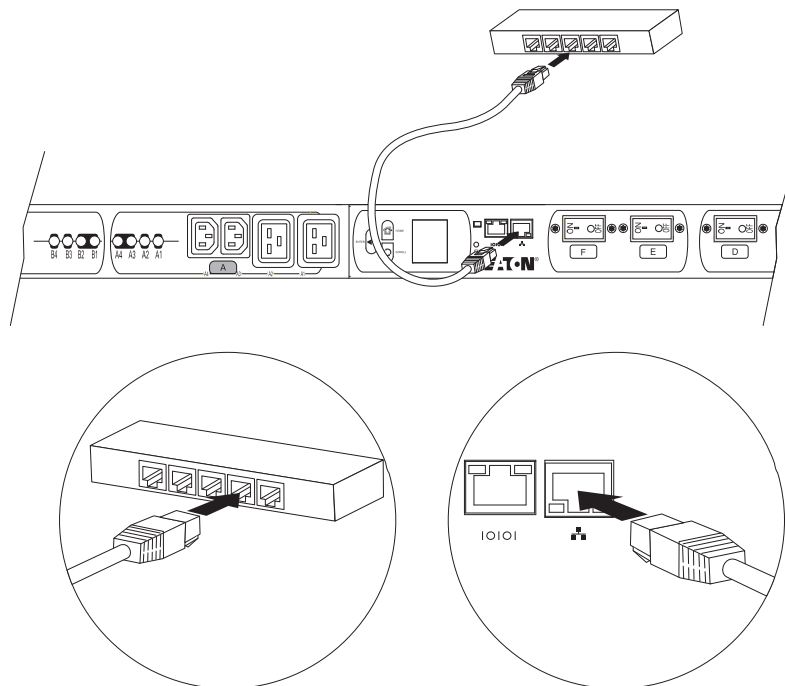

Figure 17. Connecting the ePDU to a LAN

Installing an Optional EMP

You can purchase an optional EMP to monitor temperature and humidity around the ePDU and to monitor the status of up to two contact devices.



NOTE

You can install an optional EMP now or after completing the ePDU installation and startup. An EMP can be installed without turning off power to the ePDU or the devices connected to it.

To install the optional EMP:

1. Locate the EMP.
2. If you plan to monitor one or two external contact devices, connect the external contact inputs to the screw terminals on the EMP, as described in Figure 18 and Table 3.

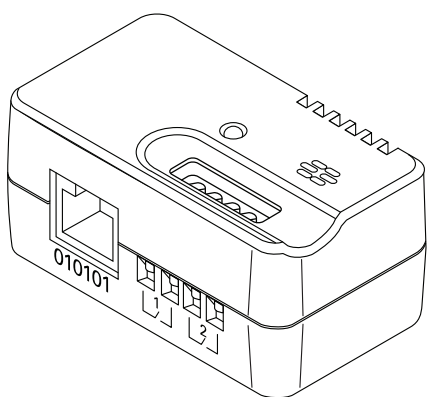

Figure 18. EMP Screw Terminals

Table 3. EMP Screw Terminal Assignment

Pin Number	Description	Normally Open/Normally Closed
1	Contact 1 returns	Normally closed
2	Contact 1 signal inputs	Normally open
3	Contact 2 returns	Normally closed
4	Contact 2 signal inputs	Normally open

NOTE Connect external contact device 1 between pins 1 and 2 (labeled as device **1**). Connect external contact device 2 between pins 3 and 4 (labeled as device **2**). External contact devices can be normally open or normally closed.

3. Locate the EMP Ethernet cable. Connect one end of the cable to the RJ-45 connector on the EMP, then connect the other end of the cable to the RS-232 connector on the ePDU. See Figure 19.

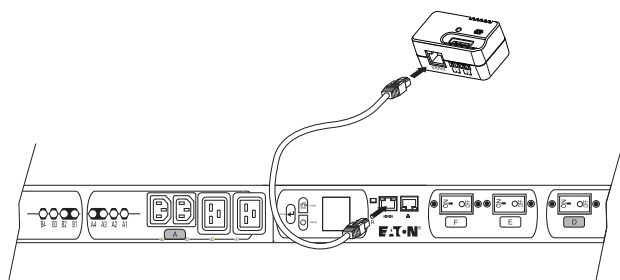

Figure 19. Connecting the EMP



NOTE If the supplied cable is not long enough for your installation, you can use another cable up to a length of 20m (65.6 ft).

4. The EMP comes with screws and Velcro fasteners. Use the method appropriate to your installation to mount the EMP in a convenient location anywhere on the rack. The EMP has a universal slot on the rear for easy mounting by screw in any direction.
5. Use the cable ties to secure the Ethernet cable out of the way as needed. On startup, the ePDU automatically recognizes the EMP.

Connecting the Output Devices

The ePDU outlets are available for connecting and monitoring devices such as workstations, servers, and printers. Connect a device you want to monitor to a power outlet on the ePDU with the power cord that comes with the device.



NOTE You may find it useful to document the connections you make using the “Equipment Setup Worksheet” on page 25.

To connect your devices:

1. Verify that each circuit breaker is in the ON position.
2. For ePDUs with detachable power cords: If the power cord is not connected, connect the power cord to the ePDU. Otherwise, go to Step 3.
3. Route the ePDU power cord toward a dedicated power source. Use cable ties to secure the power cord as needed. If the power cord must exit the rack cabinet to connect to a power source, use the openings in the rack cabinet.



NOTE 1 Plug the ePDU into an appropriately rated outlet for its type.

NOTE 2 Do not replace or rewire the power cord.

4. Connect the power cord to a properly wired and grounded dedicated power source. The ePDU turns on and displays the Eaton startup screen while starting. After five seconds, the sequence of screensaver screens for this ePDU model begin cycling.
5. Verify that no alarms display on the LCD. To resolve alarms, see Chapter 9, “Maintenance and Troubleshooting” on page 120.
6. Connect your output devices to the outlet outlets on the ePDU. Verify that each device is receiving power before connecting the next device.
7. To avoid large surge currents, perform one of the following steps:
 - Connect the protected equipment to the outlets individually rather than as a group.
 - If you have read/write access privileges for the Web interface, use “Outlet Settings” to program outlets with user-defined power-up sequences. Use the “Switch on after (s): <input delay in seconds>” setting.
8. Route all power cords neatly. If you installed the optional Cord Retention Bracket Kit, use the cable ties supplied with the kit to secure the cords to the brackets.

You can monitor the power status of a connected device either locally on the ePDU or remotely through the Web interface. For more information, see Chapter 5, “Operation Overview” on page 35.

Equipment Setup Worksheet

ePDU Series Model _____			
ePDU Series Serial Number _____			
	Outlet 1	Outlet 2	Outlet 3
Model			
Serial Number			
Use			
	Outlet 4	Outlet 5	Outlet 6
Model			
Serial Number			
Use			
	Outlet 7	Outlet 8	Outlet 9
Model			
Serial Number			
Use			
	Outlet 10	Outlet 11	Outlet 12
Model			
Serial Number			
Use			
	Outlet 13	Outlet 14	Outlet 15
Model			
Serial Number			
Use			
	Outlet 16	Outlet 17	Outlet 18
Model			
Serial Number			
Use			
	Outlet 19	Outlet 20	Outlet 21
Model			
Serial Number			
Use			
Types of adapters			
Types of cables			
Name of software program			

Chapter 4 Network Communication Configuration

All Eaton Advanced Enclosure Power Distribution Unit (ePDU) models contain an internal Network Management Card that manages the communication interfaces of the ePDUs.

The Network Management Card must be in Operation mode and basic network communication configuration must be performed before Web or Serial interfaces can be accessed. The Network Management Card must also be connected to the Local Area Network (LAN) before startup.

Enable the Network Management Card in Operation Mode

This procedure describes how to set the Network Management Card in Operation mode and enable the card before configuring IP settings.

To enable the Network Management Card in Operation mode:

1. Ensure the position of the dual in-line package (DIP) switches is **Switch 1/OFF** and **Switch 2/OFF** (see Figure 20).



NOTE

The factory default position of the DIP switches is **Switch 1/OFF** and **Switch 2/OFF**.

2. After you verify that the DIP switches are **Switch 1/OFF** and **Switch 2/OFF**, restart the Network Management Card and enable the card:
 - Insert a probe into the Reset opening (labeled R) and press down to activate the recessed reset button.
 - Retract the probe.
3. Continue to “Obtaining the IPv4 Address” on page 28 or “Obtaining the IPv6 Address” on page 31.

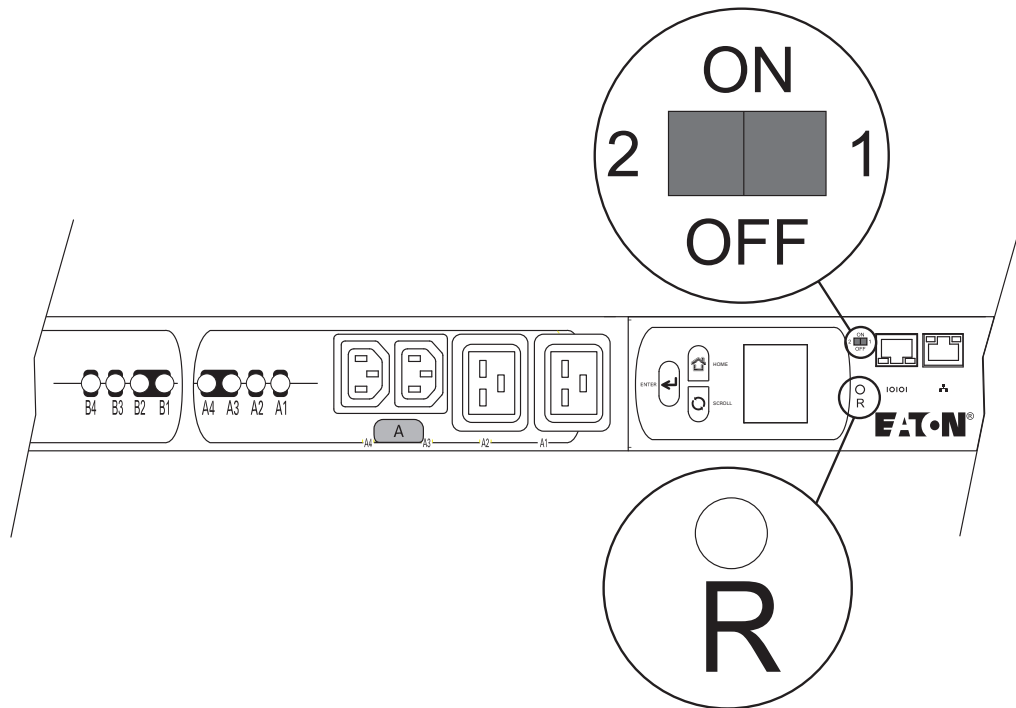

Figure 20. Operation Mode DIP Switches and Reset Opening for Probe

IP Network Configuration

The ePDU supports IPv4 and IPv6 addressing versions. After the Network Management Card is operating, you must obtain the IP address.

In order to obtain the IPv4 address, the Dynamic Host Configuration Protocol (DHCP) must be enabled. When enabled, the IPv4 settings are configured by the DHCP server. If the DHCP is disabled, the IPv4 settings are manually configured by the user.

The IPv4 address can be obtained in four ways:

1. The DHCP protocol can dynamically configure the IPv4 address, subnet mask, gateway address, and Domain Name System (DNS) servers. This requires a short retrieval process.
2. The IPv4 address can be configured using a more detailed manual process.
3. The default IPv4 address can be manually entered.
4. If a DHCP server cannot be reached, or no DHCP server is installed, a default IPv4 address is automatically used.

With either the Web or Serial interface, the DHCP Control setting indicates whether the IPv4 address is dynamically assigned by a DHCP server on the LAN. The setting is enabled by default, which means that the IPv4 address is dynamically assigned by a DHCP server on the LAN. If it is disabled, the Network Management Card uses a static IPv4 address. (For the Web interface operation, see Chapter 7, "Configure the IPv4 Settings" on page 93. For the Serial interface operation, see Chapter 8, "IPv4 Configuration" on page 101.)

In order to obtain the IPv6 address, the IPv6 address must be configured. The IPv6 address is configured in one way: The IPv6 address must always be enabled manually from either the Web interface or the Serial interface. (For the Web interface operation, see Chapter 7, “Configure the IPv6 Settings” on page 93. For the Serial interface operation, see Chapter 8, “IPv6 Configuration” on page 102.)

After the IP address is configured, you must use a software restart to restart the Network Management Card from the Web interface or Serial interface to apply a new configuration.

 **IMPORTANT**

Do not use a hardware restart to restart the Network Management Card in this case. It requires 15 seconds for the system to build the new configuration settings and make those settings permanent. If you activate a hardware restart before the 15 seconds have elapsed, all new configuration settings are lost. See “Restarting the Network Management Card” on page 42 for more information.



NOTE

When making menu selections using the Serial interface, type the number of the menu selection in the **Please enter your choice => prompt** and press [Enter].

Obtaining the IPv4 Address

After the ePDU is started and the Network Management Card runs in Operation mode:

1. Verify that the serial cable is connected between the ePDU serial (RS-232) port and the PC COM port.
2. Use a PC terminal emulator program such as HyperTerminal with the following settings:
 - Baud rate (bits per second) = 9600
 - Data bits = 8
 - Stop bits = 1
 - Parity = None
 - Flow control = None
3. Disable the “Echo typed characters locally” option.
4. Press [Enter]. The Login menu displays (see Figure 21).

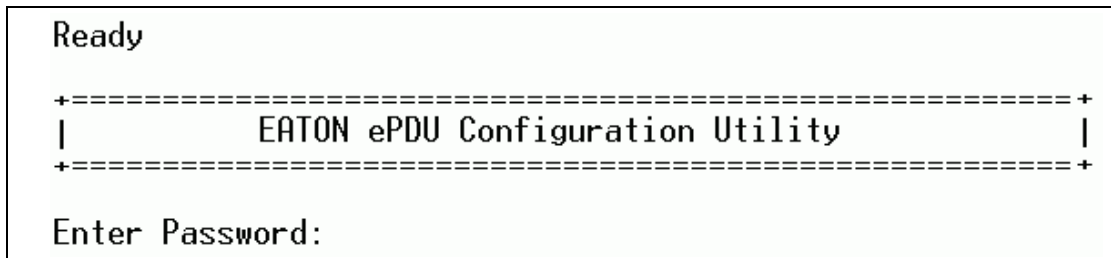

Figure 21. Login Menu

5. Type the Superuser password. The Eaton ePDU Configuration Utility menu displays.

6. Type **1** (Network Management Card Settings) and press [Enter] (see Figure 22).

```

=====
|                                     |
|                               EATON ePDU Configuration Utility |
|                               |
| 1. Network Management Card Settings |
| 2. Factory Reset (Network Management Card only) |
| 3. Restart Network Management Card |
| 4. Firmware Upgrade Mode |
| 5. Clear ePDU & System Log |
| 0. Exit |
|                                     |
Please enter your choice =>
    
```

Figure 22. Eaton ePDU Configuration Utility

7. Type **2** (Network Settings) and press [Enter].
8. Type **3** (Communication Control) and press [Enter] (see Figure 23).

```

=====
|                                     |
|                               EATON ePDU Configuration Utility |
|                               |
| Ethernet Address       : 00:20:85:F9:00:BE |
|                               |
| 1. IPv4 Configuration |
| 2. IPv6 Configuration |
| 3. Communication Control |
| 4. Hostname           : epduBE |
| 5. Primary DNS IP Address : XXX.XXX.XXX.25 |
| 6. Secondary DNS IP Address : XXX.XXX.XXX.27 |
| 0. Return to previous menu |
|                               |
WARNING: Restart the Network Management Card to apply a new configuration
Please enter your choice =>
    
```

Figure 23. Network Settings Menu

9. Type **2** (DHCP Control) and press [Enter] to enable or disable DHCP Control (see Figure 24).

```

=====
|                                     |
|                               EATON ePDU Configuration Utility |
|                               |
| 1. Ethernet Control      : Auto Negotiation |
| 2. DHCP Control          : Enabled |
| 3. FTP Upgrade Control   : Enabled |
| 4. Telnet Control |
| 5. HTTP Control |
| 6. SSL Control |
| 7. SNMP Control |
| 0. Return to previous menu |
|                               |
WARNING: Restart the Network Management Card to apply a new configuration
Please enter your choice =>
    
```

Figure 24. Communication Control Menu

10. Choose one of the following procedures:
 - If your network is equipped with a DHCP server, type **1** and press [Enter] to enable DHCP. Continue to Step 18.
 - If your network is not equipped with a DHCP server, type **0** and press [Enter] to disable DHCP. Continue to Step 11.
11. Type **0** (Network Settings) and press [Enter].
12. Type **1** (IPv4 Configuration) and press [Enter]. The default settings display (see Figure 25).
13. Type **1** (IPv4 Address) and press [Enter].
14. Type the IPv4 address and press [Enter].
15. Type **2** (Gateway Address) and press [Enter].
16. Type the IPv4 address of the gateway (if any) and press [Enter].
17. Type **3** (Network Mask) and press [Enter]. Type the subnet mask and press [Enter].

```

+-----+
|                                     |
|               IPv4 Configuration Menu               |
|-----+-----+
| 1. IPv4 Address    : XXX.XXX.XXX.49               |
| 2. Gateway Address : XXX.XX.XXX.1                 |
| 3. Network Mask    : 255.255.255.0                |
| 0. Return to previous menu                        |
|-----+-----+
| WARNING: Restart the Network Management Card to apply a new configuration |
| Please enter your choice =>                     |
|-----+-----+
  
```

Figure 25. IPv4 Configuration Menu

18. Type **0** (Return to previous menu) and press [Enter].
19. Type **0** (Return to previous menu) and press [Enter].
20. Type **0** (Return to previous menu) and press [Enter].
21. Type **3** (Restart Network Management Card) and press [Enter]. The Network Management Card restarts with the new IP settings after approximately 30 seconds.

Retrieve the IPv4 Address

1. Verify that the serial cable is connected between the ePDU Serial (RS-232) port and the PC COM port.
2. Use a PC terminal emulator program such as HyperTerminal with the following settings:
 - Baud rate (bits per second) = 9600
 - Data bits = 8
 - Stop bits = 1
 - Parity = None
 - Flow control = None
3. Disable the "Echo typed characters locally" option.
4. Press [Enter]. The Login menu displays.
5. Type the Superuser password. The Eaton ePDU Configuration Utility menu displays.
6. Type **1** (Network Management Card Settings) and press [Enter].

7. Type **2** (Network Settings) and press [Enter].
8. Type **1** (IPv4 Configuration) and press [Enter]. The settings supplied by the server display in the IP Configuration Menu.
9. Note the IP address.

**NOTE**

You can also use the Intelligent Power Manager (IPM) software utility to view the card's IP address. IPM must be installed on a network-connected PC. The tool is available at <http://powerquality.eaton.com/Support/Software-Drivers>.

Using the IPv4 Default Address Configuration

Dynamically obtaining the IPv4 address from the DHCP server, or obtaining the IPv4 address configuration using manual entry are not the only ways to connect to the ePDU and access the Web interface.

A default IPv4 address can also be used to connect to the ePDU and the Web interface. This can occur automatically or by manual entry.

Automatic default address configuration occurs as follows:

If a DHCP server is not available or not installed, the Network Management Card attempts several times within 1.5 minutes to reach a DHCP server. If these attempts are unsuccessful, the default address is automatically configured since the DHCP server failed to perform a dynamic IPv4 address configuration.

To manually enter the default address:

1. Access a Web browser.
2. Type the default address in the address bar: **http://192.168.123.123**

The Web interface opens with the ePDU Overview (Home) page.

Obtaining the IPv6 Address

Before obtaining the IPv6 address, you must configure IPv6 either using auto-configuration or manually for networks that do not allow auto-configuration.

1. Verify that the serial cable is connected between the ePDU serial (RS-232) port and the PC COM port.
2. Use a PC terminal emulator program such as HyperTerminal with the following settings:
 - Baud rate (bits per second) = 9600
 - Data bits = 8
 - Stop bits = 1
 - Parity = None
 - Flow control = None
3. Disable the "Echo typed characters locally" option.
4. Press [Enter]. The Login menu displays.
5. Type the Superuser password. The Eaton ePDU Configuration Utility menu displays.
6. Type **1** (Network Management Card Settings) and press [Enter].
7. Type **2** (Network Settings) and press [Enter].
8. Type **1** (IPv6 Control) and press [Enter].

9. Type **1** (Enabled) and press [Enter].
10. Does your network allow IPv6 Auto-configuration?
 - If yes, continue with the next section, “Networks That Allow Auto-Configuration”.
 - If no, continue to “Networks That Do Not Allow IPv6 Auto-Configuration” on page 32.

Networks That Allow Auto-Configuration

1. Type **2** (IPv6 Auto-Configuration) and press [Enter].
2. Type **1** (Enabled) and press [Enter].
3. Type **0** (Return to previous menu) and press [Enter].
4. Type **0** (Return to previous menu) and press [Enter].
5. Type **0** (Return to previous menu) and press [Enter].
6. Type **3** (Restart Network Management Card) and press [Enter]. The Network Management Card restarts with the new IP settings after approximately 30 seconds.
7. Return to the Eaton ePDU Configuration Utility menu to obtain the auto-configured IPv6 addresses.
8. Type **1** (Network Management Card Settings) and press [Enter].
9. Type **2** (Network Settings) and press [Enter].
10. Type **2** (IPv6 Configuration) and press [Enter].
11. The IPv6 settings are displayed.

Networks That Do Not Allow IPv6 Auto-Configuration

1. From the IPv6 Configuration Menu, type **2** (IPv6 Auto-Configuration) and press [Enter].
2. Type **0** (Disabled) and press [Enter].
3. Type **3** (IPv6 Global Address 1) and press [Enter].
4. Type the IPv6 address.
5. Type **3** (IPv6 Global Prefix 1) and press [Enter].
6. Type the IPv6 prefix.
7. Type **5** (IPv6 Default Router) and press [Enter].
8. Type the IPv6 default router.
9. Type **0** (Return to previous menu) and press [Enter].
10. Type **0** (Return to previous menu) and press [Enter].
11. Type **0** (Return to previous menu) and press [Enter].
12. Type **3** (Restart Network Management Card) and press [Enter].
13. Type **3** (Restart Network Management Card) and press [Enter]. The Network Management Card restarts with the new IP settings after approximately 30 seconds.



NOTE

When you modify parameters, you can press [Enter] to select the value shown in braces, or you can type a new value and press [Enter].

Retrieve the IPv6 Address

1. Verify that the serial cable is connected between the ePDU serial (RS-232) port and the PC COM port.
2. Use a PC terminal emulator program such as HyperTerminal with the following settings:
 - Baud rate (bits per second) = 9600
 - Data bits = 8
 - Stop bits = 1
 - Parity = None
 - Flow control = None
3. Disable the "Echo typed characters locally" option.
4. Press [Enter]. The Login menu displays.
5. Type the Superuser password. The Eaton ePDU Configuration Utility menu displays.
6. Type **1** (Network Management Card Settings) and press [Enter].
7. Type **2** (Network Settings) and press [Enter].
8. Type **1** (IPv6 Configuration) and press [Enter]. The IPv6 settings display.
9. Note the IPv6 address (see Figure 26).

```

+-----+
|                                     |
|                                     |
+-----+
|                                     |
|                                     |
| IPv6 Configuration Menu           |
|                                     |
+-----+
| IPv6 Link-local Address:          |
| IPv6 Global Address 1 :          |
| IPv6 Global Prefix 1  : 0        |
| IPv6 Global Address 2 :          |
| IPv6 Global Prefix 2  : 0        |
| Address Status        : Invalid   |
|                                     |
| 1. IPv6 Control           : Disabled |
| 2. IPv6 Auto-Configuration : Disabled |
| 3. IPv6 Global Address 1  :          |
| 4. IPv6 Global Prefix 1   : 0        |
| 5. IPv6 Default Router    :          |
| 0. Return to previous menu      |
|                                     |
| WARNING: Restart the Network Management Card to apply a new configuration |
| Please enter your choice =>      |
|                                     |
+-----+

```

Figure 26. IPv6 Configuration Menu**NOTE**

You can also use the Intelligent Power Manager (IPM) software utility to view the card's IP address. IPM must be installed on a network-connected PC. The IPM tool is available at <http://powerquality.eaton.com/Support/Software-Drivers>.

Verify Network Management Card Operation

To determine if the Network Management Card is operational after IPv4 or IPv6 network configuration is completed:

1. Access a Web browser.
2. Type the IPv4 or IPv6 address in the address bar in the following format: **http://IPv4 address** or **http://[IPv6 address]**
3. Type the user name and password in the Authentication dialog. Click **Login**.

The Web interface opens with the ePDU Overview (Home) page.

Chapter 5 Operation Overview

This chapter introduces the operation features of the Eaton Advanced Enclosure Power Distribution Unit (ePDU).

Figure 27 shows an isolated view of the display and connectivity areas.

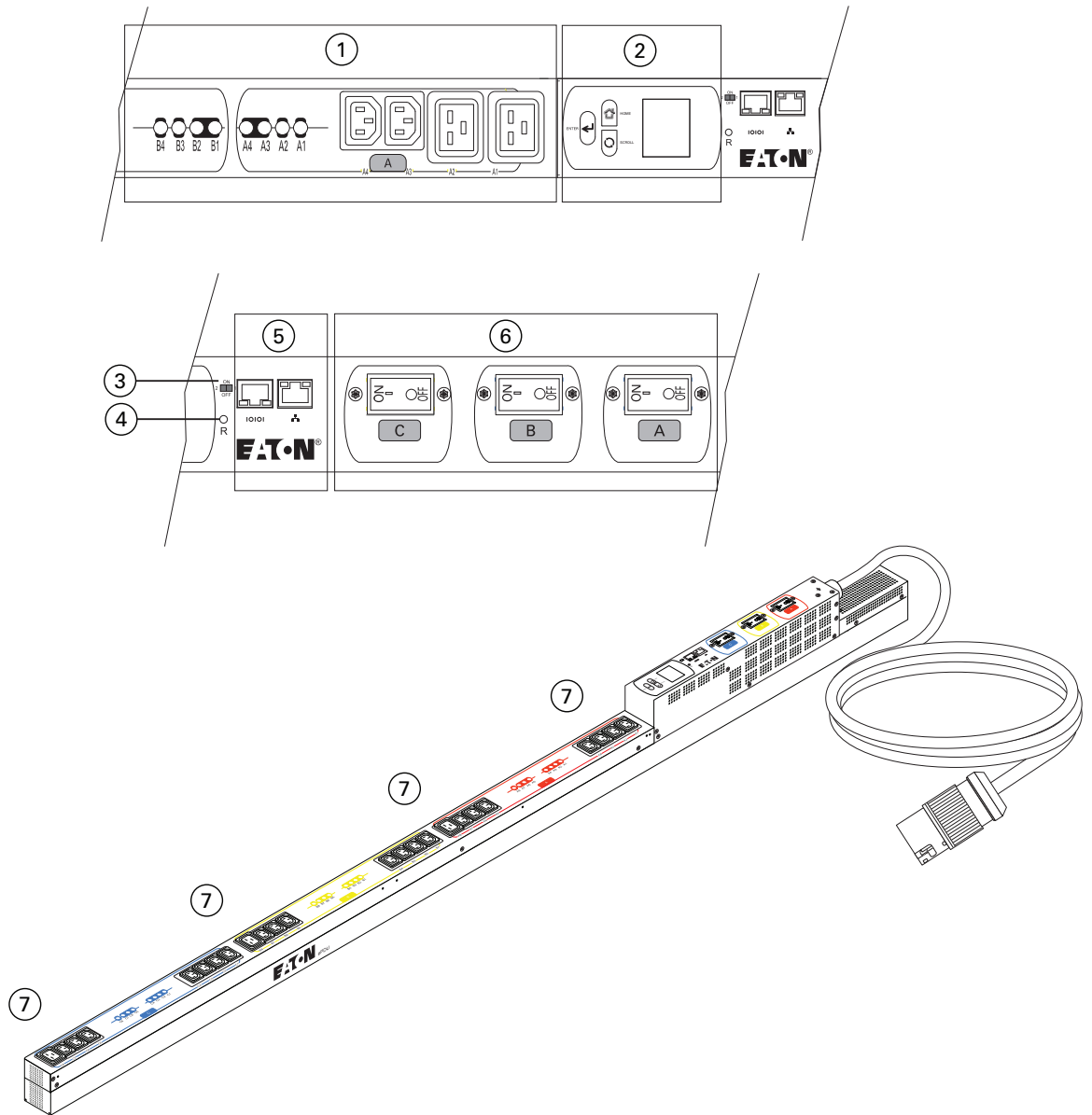

Figure 27. Eaton ePDU Display and Connectivity

Table 4 describes the operation features shown in Figure 27.

Table 4. Display and Connectivity Features

Reference Number	Feature	Description
1	Outlet Group management	<p>Power outlet LEDs: On or Off depending on whether the outlet is powered or not powered. Also indicates whether alarms are present for the outlet.</p> <ul style="list-style-type: none"> • On: Outlet is powered. • Off: Outlet is not powered. • Flashing: An alarm for this outlet is active. <p>C19 and C13 power outlets: Connect one device to be protected per outlet. The outlets are grouped so that you can identify, manage, and monitor the outlets in groups. Group configuration cannot be changed. For more information, see “Outlet Groups Management” on page 38.</p>
2	Menu and Status display	<p>Liquid Crystal Display (LCD) Window: Displays information about load status, events, measurements, identification, and settings. The LCD also provides some basic configuration. For more information, see “Menu and Status Display” on page 40.</p> <p>Navigation buttons: Navigate through the display. For more information, see “Menu and Status Display” on page 40.</p>
3	Operation mode DIP switch	Changes the mode of operation for the ePDU to upgrade or read-only operation. The default setting is normal operation. For more information, see “Operation Mode DIP Switches” on page 42.
4	Reset opening	Restarts the ePDU Network Management Card. Resetting the ePDU does not affect the loads. Insert and retract a probe in the Reset opening to perform a Network Management Card restart.
5	Connectivity and Monitoring ports	<p>Serial Service and Communication Port: Connects to the serial (COM) connector on a computer with a DB9-to-RJ-45 cable, allowing the computer to act as a configuration console. Alternately used for the Environmental Monitoring Probe (EMP) connection in order to collect temperature and humidity data.</p> <p>Ethernet Port Connector: Connects to a Local Area Network (LAN), allowing configuration through a 10/100 auto sensing network connection.</p>
6	Circuit breakers	<p>Activate if the load current rating of a power outlet exceeds 16A (Europe) / 20A (US). Power to the outlet turns off automatically. To reset the circuit breaker, turn the breaker from OFF to ON.</p> <p>NOTE To manually disconnect power to a device that is connected to the ePDU, disconnect the device’s power cord from the ePDU power outlet.</p>
7	Power outlets	Allows you to connect one device to each outlet. The outlets are grouped so that you can identify, manage, and monitor the outlets in groups. Group configuration cannot be changed. For more information, see “Outlet Groups Management” on page 38.

Three-Phase Configurations

The type of ePDU input connector plug varies by model to accommodate different amperage ratings. The IEC60309 connector plugs are configured as delta or wye topologies as follows:

- The delta configuration uses a four-wire input connector plug with three phase wires, a protective earth (ground) wire, and no neutral wire. This is commonly expressed as 3W+PE (delta).
- The wye configuration uses a five-wire input connector plug with three phase wires, a protective earth (ground) wire, and a neutral wire. This is commonly expressed as 3W+N+PE (wye).

Table 5 shows examples and descriptions of delta and wye configuration codes.

Table 5. Example Three-Phase Topologies

Code	4-pin Plug (delta) - 4 5-pin Plug (wye) - 5	Maximum Amperage (A) Rating	Plug (P) outlet/Socket (R) or Connector (C)	Clock Position (6 or 9)	Waterproof (W) or Splash Resistant (S)
460P9W	4	60	P	9	W
532P6S	5	32	P	6	S

Environmental Protection and Pin Alignment

The input connector plugs have Ingress Protection (IP) ratings that specify the degree of environmental protection for electrical equipment. The IEC60309 input connector plugs that are either splash resistant (S) or waterproof (W).

- Splash resistant plugs are IP-rated at IP 44, which means the plug is protected against solid objects less than 1.0 mm in diameter.
- Waterproof plugs are IP-rated at IP 67, which means the plugs are watertight, splashproof, and dust tight.

The pin alignment is different for four-wire (delta) and five-wire (wye) configurations. This orientation is commonly expressed as a clock position. See Figure 28 for example clock positions.

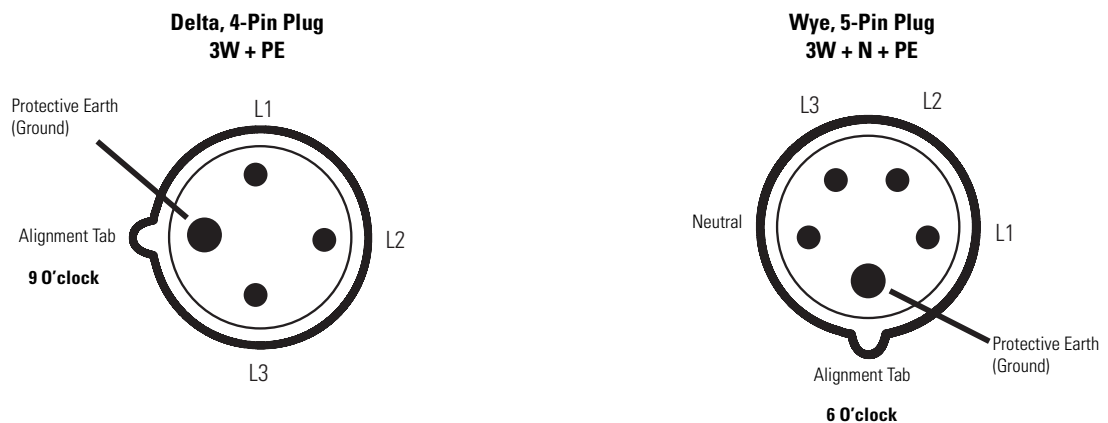

Figure 28. Example Clock Positions

Outlet Groups Management

Outlet groups are preset groups of individual outlets that you can identify, manage, and monitor through the different interfaces that are available with the ePDU. For each phase, there is a color-coded outlet group and corresponding circuit breaker on the ePDU. The outlet groups and circuit breakers for each phase are labeled and color coded for easy identification, as shown in Figure 29.



NOTE

A status LED is illuminated when an outlet is powered. The outlet flashes when the outlet alarm is triggered.

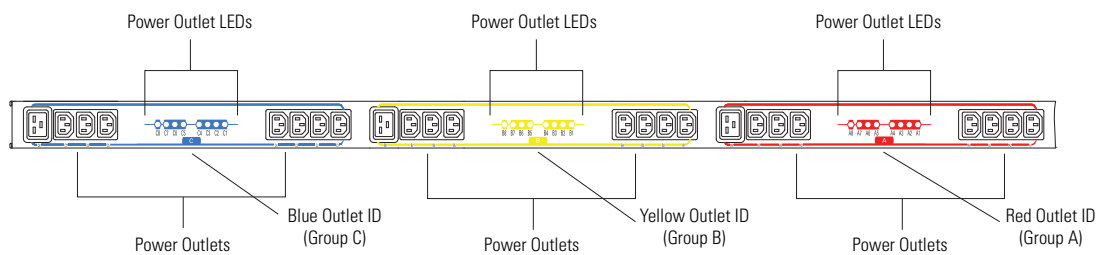
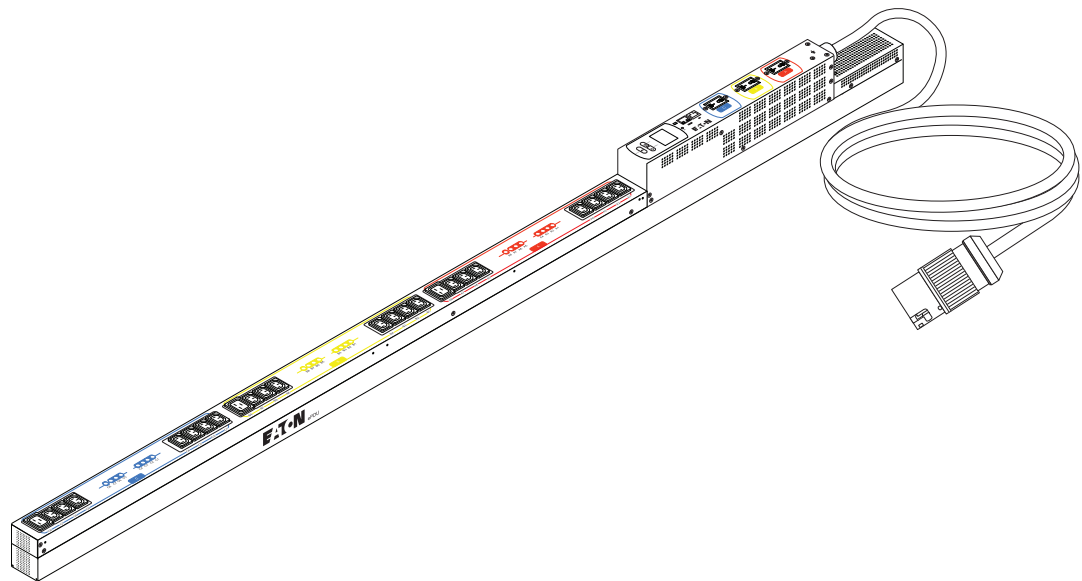

Figure 29. Outlet Groups, LEDs, and Group Circuit Breakers (eMA007 3-Phase Model Shown)

Table 6 defines the outlet groups for each model. Group configuration cannot be changed.

Table 6. Eaton ePDU Outlet Groups

Model	A	B	C	D	E	F
eSWA01	A1 to A8	B1 to B8	—	—	—	—
eSWA02	A1 to A12	B1 to B12	—	—	—	—
eSWA03	A1 to A12	B1 to B12	—	—	—	—
eSWA04	A1 to A12	B1 to B12	—	—	—	—
eSWA05	A1 to A8	B1 to B8	C1 to C8	—	—	—
eAMA06	A1 to A8	B1 to B8	—	—	—	—
eAMA07	A1 to A12	B1 to B12	—	—	—	—
eAMA08	A1 to A12	B1 to B12	—	—	—	—
eAMA09	A1 to A12	B1 to B12	—	—	—	—
eMAA10	A1 to A8	B1 to B8	—	—	—	—
eMAA11	A1 to A12	B1 to B12	—	—	—	—
eMAA12	A1 to A12	B1 to B12	—	—	—	—
eMAA13	A1 to A12	B1 to B12	—	—	—	—
eMAA14	A1 to A8	B1 to B8	C1 to C8	—	—	—
eAM001	A1 to A12	B1 to B12	—	—	—	—
eAM002	A1 to A8	B1 to B8	C1 to C8	—	—	—
eAM003	A1 to A8	B1 to B8	C1 to C8	—	—	—
eAM004	A1 to A8	B1 to B8	C1 to C8	—	—	—
eAM005	A1 to A4	B1 to B4	C1 to C4	D1 to D4	E1 to E4	F1 to F4
eAM008	A1 to A12	B1 to B12	—	—	—	—
eMA006	A1 to A8	B1 to B8	C1 to C8	—	—	—
eMA007	A1 to A8	B1 to B8	C1 to C8	—	—	—
eMA009	A1 to A4	B1 to B4	C1 to C4	D1 to D4	E1 to E4	F1 to F4
eMA010	A1 to A12	B1 to B12	—	—	—	—
eMA011	A1 to A8	B1 to B8	C1 to C8	—	—	—
eMA012	A1 to A12	B1 to B12	—	—	—	—
eMA013	A1 to A8	B1 to B8	C1 to C8	—	—	—
eMA014	A1 to A8	B1 to B8	C1 to C8	D1 to D4	E1 to E4	F1 to F4

NOTE Models with outlet groups protected by circuit breakers are in bold type.

Menu and Status Display

The LCD provides information in English about the ePDU and connected devices using white text on a blue background. The LCD window flashes orange when any alarm is active.

Basic configuration of some settings is available through the LCD. Full configuration of all settings is available through the remote interfaces. For more information about configuration, see Chapter 4, “Network Communication Configuration” on page 26.

LCD Window

The LCD has three modes:

- **Screensaver mode** (startup screen)

Screensaver mode cycles through a set sequence of screens that display the following information:

- ePDU frequency, power, and current
- Phase power and current (for three-phase models)
- Outlet group power and current
- Environmental measurements (with the optional EMP installed)

- **Settings mode** (LCD main menu)

The menus that display depend on your ePDU model. For more information about the menus and settings for your model, refer to Chapter 6, “LCD Operation” on page 68.

- **Energy Saving mode** (dark screen)

Turning the backlight off conserves energy but darkens the screen. Pressing any of the navigation buttons turns the backlight on. An active alarm also turns the backlight on. The LCD automatically turns off after 15 minutes if no button is pressed.

Figure 30 shows the LCD window and navigation buttons.

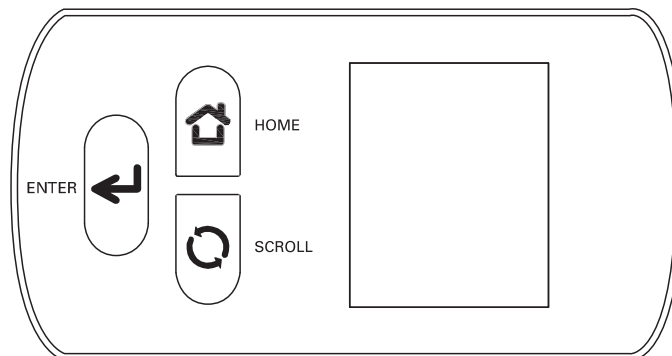

Figure 30. LCD Window and Navigation Buttons

In this document, the LCD selection screens are easily distinguished from display screens. The selection screens are presented as solid blue with no contrasting border. The display screens are presented as blue with an orange border.

Figure 31 shows the format of the LCD selection and display screens.

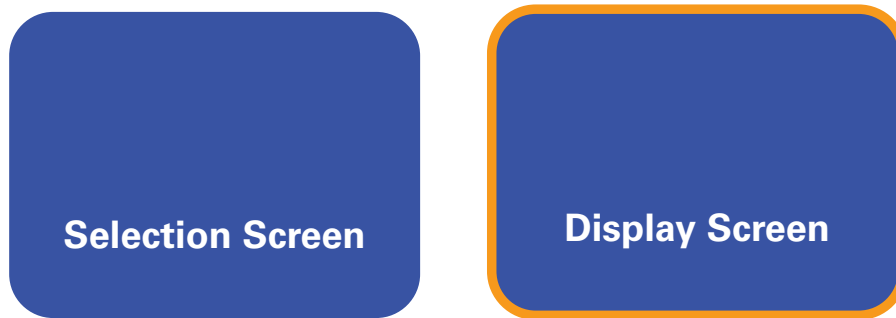

Figure 31. Display and Selection Screen Formats

The menu items are highlighted when they are selected. Figure 32 illustrates LCD menu item selection.

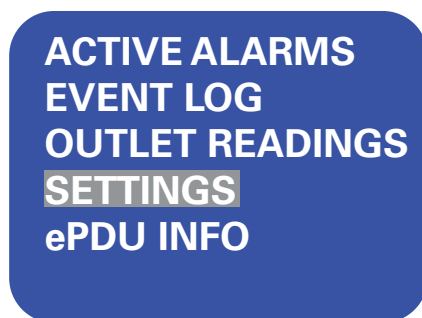

Figure 32. Menu Item Selection

LEDs on the ePDU signal basic operation behavior. For example, Advanced ePDUs indicate that outlets are powered (on) by steady light. Advanced ePDUs also indicate the outlets are unpowered (off) when the LED is not illuminated. Typically, if the LED is blinking, there is an alarm condition.

i NOTE Only Advanced Monitored (AM) and Managed (MA) ePDUs indicate alarms by blinking LEDs. Switched (SW) ePDUs do not.

Figure 32 illustrates power outlet LEDs.

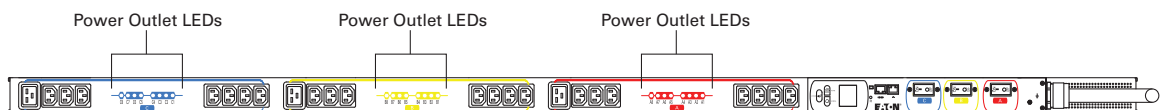

Figure 33. Power Outlet LEDs

Operation Mode DIP Switches

The dual in-line package (DIP) switches set the Operation mode for the ePDU. Table 7 and Figure 34 show the settings and positions for various operation modes. Leave the DIP switches in their default position (Switch 1/OFF and Switch 2/OFF) for normal operation.

Table 7. DIP Switch Mode Settings

Switch 1	Switch 2	Operation Mode	Description
ON	ON	Serial upgrade of the LCD control board firmware	Use when upgrading the ePDU locally by using a DB9-to-RJ-45 cable.
ON	OFF	Upgrade of the Network Management Card firmware	Use when upgrading the Network Management Card remotely through the Ethernet network using FTP protocol.
OFF	ON	Read-only mode	The ePDU runs normally, but users cannot change any settings regardless of access rights.
OFF	OFF	Operational mode	Default setting for normal operation.

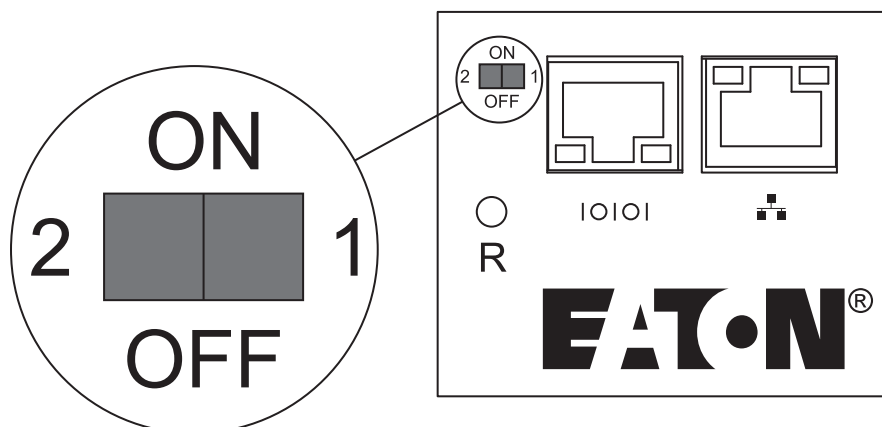

Figure 34. Example Operation Mode DIP Switch Positions

Restarting the Network Management Card

The Network Management Card can be restarted by a hardware or software method. The Network Management Card must be reset if a firmware upgrade is forced using the DIP switch configuration Switch 1/ON and Switch 2/OFF. Neither method restarts the ePDU nor changes the power status of the outlets.

! IMPORTANT

Restarting the ePDU will not affect the output power or the connected equipment.

Hardware Restart

The Reset button is used to restart the internal Network Management Card by the hardware method. To restart and enable the Network Management Card, insert a probe into the Reset opening (labeled R), press the recessed button, and then retract the probe. The ePDU exits Firmware Upgrade mode (see Figure 35).



NOTE

When using a hardware restart to restart the Network Management Card, there is no mandatory check to ensure that the file system parameters are saved before restarting.

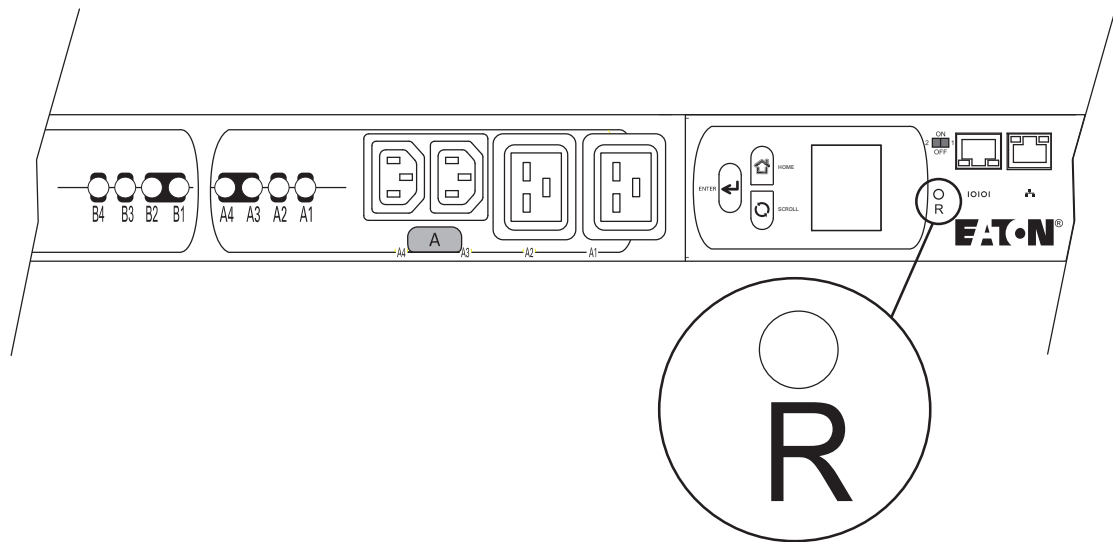

Figure 35. Reset Opening

Software Restart

A software application restart can be initiated by Web interface selections or Serial interface commands.



NOTE

When using a remote interface to perform a software restart, the Network Management Card saves all current settings before restarting.

LED Status Indicators

The Advanced ePDUs include communication and environmental monitoring ports, operation buttons, and operation switches (see Figure 36).

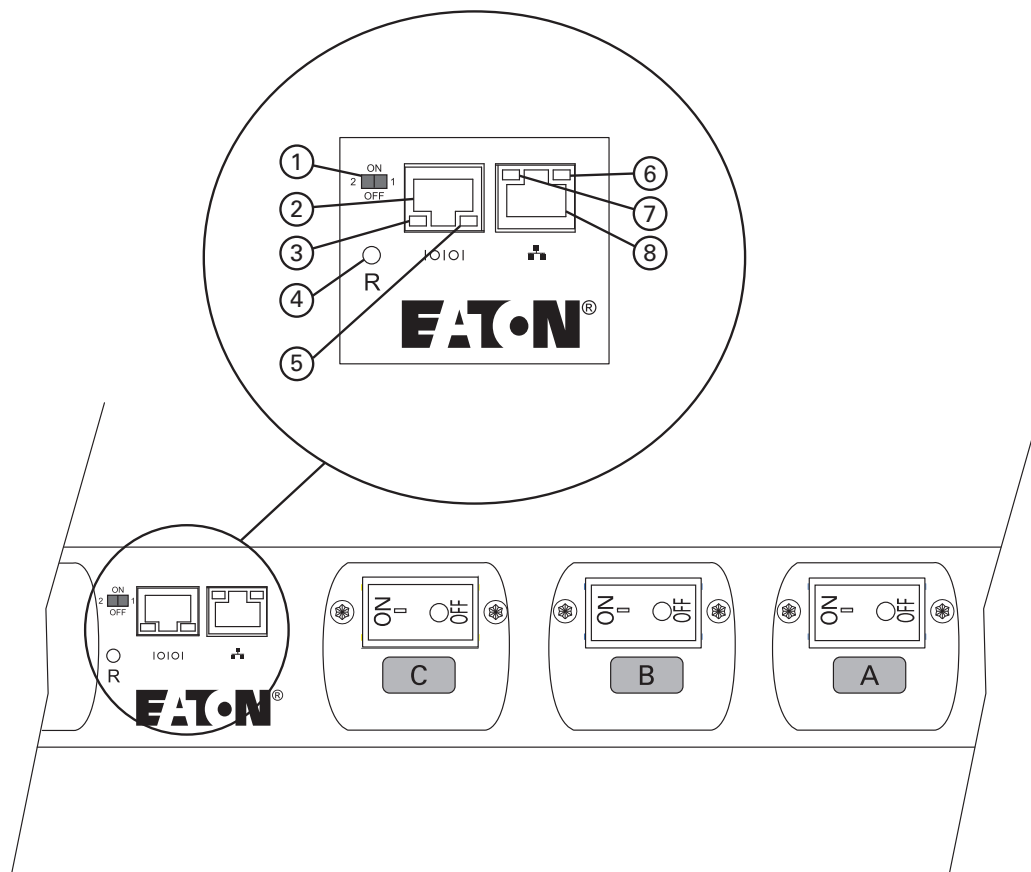

Figure 36. Communication and Environmental Monitoring Ports

Table 8. Communication and Environmental Monitoring Ports

Reference Number	Description
1	DIP Switches
2	Service or Serial Port (Settings/Sensor)
3	Serial Service Port Orange LED: RS-232 Activity Status
4	Reset Opening
5	Serial Service Port Green LED: ePDU Communication Status
6	Ethernet Port Green LED; 10/100M Status
7	Ethernet Port Orange LED: Connection and Activity Status
8	Ethernet 10/100 Base-T Port

Serial and Ethernet Connection Status

The serial and Ethernet connectors provide status indicators. The color display and the LED state convey the operation condition of the ePDU. Table 9 provides a description of the LED displays for the serial and Ethernet connectors.



NOTE At startup, check the LED status display colors on the communication and monitoring ports to ensure that they are operating correctly.

Table 9. Status Color Definitions for LED Indicators

Port	Description
Serial connector	<p>Connects to the serial (COM) connector on a computer with a DB9-to-RJ-45 cable, allowing the computer to act as a configuration console.</p> <ul style="list-style-type: none"> Green LED OFF when the ePDU is starting. Green LED ON when the Network Management Card starts communicating with the ePDU. Green LED Flashes when the Network Management Card is operational. Orange LED OFF when the console menu is activated. Orange LED ON for normal operation, but the console menu is not activated. Orange LED Flashes when the Network Management Card card is communicating with the EMP sensor (optional equipment). <p>NOTE The LED also flashes when no device is connected to the ePDU.</p>
Ethernet connector	<p>Connects to a LAN, allowing access through a 10/100 autosensing network connection. Used for remote configuration and equipment monitoring. Can be used as an Environmental Monitoring Probe (EMP) sensor connector instead.</p> <ul style="list-style-type: none"> Green LED OFF when the port is operating at 10 Mbits/s. Green LED ON when the port is operating at 100 Mbits/s. Orange LED OFF when the ePDU is not connected to the network. Orange LED ON when the ePDU is connected to a 10 Mb network, but with no activity. Orange LED Flashes while data is transmitted and received.

Remote Interfaces

You can communicate with the ePDU using the remote interfaces listed in Table 10.

Table 10. Remote Interfaces

Interface	Description	ePDU Connector	Cable (supplied)	Cabling Instructions
Console emulator (such as HyperTerminal)	Serial interface to a computer	RS-232 connector ***	DB9-to-RJ-45 cable	"Connecting to a Computer Serial Port" on page 20
Web browser *	Interface through an Internet web browser	Ethernet connector	Ethernet cable	"Connecting to a LAN Ethernet Port" on page 22
SNMP **	Standard Internet protocol for managing devices on networks			
Telnet	Terminal emulation protocol for configuring the Network Management Card	RS-232 connector *** or Ethernet connector	Ethernet cable or DB9-to-RJ-45 cable	"Connecting to a Computer Serial Port" on page 20 or "Connecting to a LAN Ethernet Port" on page 22

* Supports Microsoft® Internet Explorer® 6.0 and greater, Mozilla® Firefox® 3.6 and greater, Google Chrome™ 4 and greater.

** Supports Simple Network Management Protocol (SNMP) v1, v2, and v3. Provides ability to send traps, retrieve outlet specific data, set ePDU and outlet values, and notify of events through SNMP trap or e-mail alert.

*** If you install an optional EMP, you must dedicate the RS-232 connector to the EMP. (The EMP Ethernet cable is supplied in the EMP shipping carton.)

Operation Concepts

This section provides information describing the following Advanced ePDU operation concepts:

- User Login and Access Policy
- Power Schedules for Managed and Switched ePDUs
- Group Definition

User Login and Access Policy

The web interface is protected by a login and a password. The Network Management Card manages up to eight users and one Administrator.

A user is defined by:

- Name identifier (login)
- Password (minimum of five characters)
- Assigned access rights (Read Only, Read/Write, Read/Write/Control, No Access)
- List of groups of outlets to which the user has access



NOTE At a minimum, users need Read-Only access rights to access the Web pages.

When a user accesses the Web interface, the system prompts for a login and password. The login and password for the administrator and for each user are hashed using a one-way hash algorithm. If the login and password match and the assigned user rights do not restrict access, the user can access the Web interface.



IMPORTANT

Users should always terminate sessions by clicking the logout link in the top right-hand corner of the Web interface page.

User profiles are also defined by collocation. Collocation restricts or allows user access to view and modify Advanced ePDU data, such as outlet state, operational measurements, threshold settings, power schedules, and alarms.

Three user profiles can be configured:

- Administrator
- Non-collocated user
- Collocated user

Administrator

An administrator can use all menus in the Web interface and all commands in the Serial interface. The Administrator is always assigned Read/Write/Control access rights. The administrator is the only user type with permission to perform the following:

- Create, modify, or disable a user-defined group
- Attach groups or outlets to users
- Configure e-mail recipient addresses for e-mail notification to users
- Configure power schedules for users
- Access the command line interface (CLI) serial menu interface.

**NOTE**

The default login and password is "admin." An administrator should always change the default at the first connection. If the administrator loses the password or login, contact your service representative to recover it.

Non-Collocated User

A non-collated user can be assigned Read/Write/Control, Read/Write, Read-only, or No access privileges. With the exception of the following restrictions, the non-collocated user has access to the same functions as the administrator:

- Cannot attach groups or outlets to users
- Cannot change the configurations that belong to a collocated user, such as power schedules or e-mail addresses for notifications
- Cannot modify a defined group, e-mail address, or power schedule that the Administrator has assigned to a collocated user
- Cannot access the Serial interface; must use the Web interface only

**NOTE**

A user is considered to be non-collocated if the administrator does not attach groups to that user.

Collocated User

A collated user can be assigned Read/Write/Control, Read/Write, Read-only, or No access privileges. A collocated user has limited access and specific functions assigned to him by the administrator, including:

- Access to groups and outlets assigned by the administrator
- Access to power schedules and the e-mail address assigned by the administrator
- Access to alarms and logs generated by outlets assigned by the administrator
- Authority to change the password but not the login
- Access to a restricted menu, including all global for menu bar selections
- Cannot access the Serial interface; must use the Web interface only

Table 11 and Table 12 provide permission details for Non-collated and Collocated users.

Table 11. Non-allocated User Permission Details

Web Interface Selection	Access Privileges and Restrictions		SW	AM	MA	MA3
ePDU Overview	ePDU Overview Setting configuration and reset Kwh	R/W	•	•	•	•
		R/W/C				
ePDU Groups	ePDU Group Setting configuration	R/W	•	•	•	•
		R/W/C				
	ePDU Group switching On/Off	R/W/C	•	—	•	•
ePDU Outlets	ePDU Outlet Setting configuration	R/W	•	•	•	•
		R/W/C				
	ePDU Outlet switching On/Off	R/W/C	•	—	•	•
Power Schedule	ePDU Power Schedule data access for review only	R	•	—	•	•
		R/W				
		R/W/C				
	ePDU Power Schedule configuration <small>SEE NOTE</small>	R/W/C	•	—	•	•
	ePDU Power Schedule assignment to users	Not Permitted	•	—	•	•
Email Notification	ePDU Email address data access for review only	R	•	•	•	•
		R/W				
		R/W/C				
	ePDU Email address configuration <small>SEE NOTE</small>	R/W	•	•	•	•
		R/W/C				
	ePDU Email address assignment to users	Not Permitted	•	•	•	•
Trap Receiver	ePDU Trap Receiver configuration	R/W	•	•	•	•
		R/W/C				
Group Definition	ePDU Group data access for review only	R	•	•	•	•
		R/W				
		R/W/C				
	ePDU Group configuration <small>SEE NOTE</small>	R/W	•	•	•	•
			R/W/C			
	ePDU Group assignment to users	Not Permitted	•	•	•	•
Access Control	Login/Password Configuration	R/W	•	•	•	•
		R/W/C				
Network	ePDU Network parameters configuration	R/W	•	•	•	•
		R/W/C				
System	ePDU System settings configuration and Network Management Card/ePDU configuration file download	R/W	•	•	•	•
		R/W/C				
	ePDU System Network Management Card/ePDU configuration file upload	Not Permitted	•	•	•	•
SNMP	ePDU SNMP parameters configuration	R/W	•	•	•	•
		R/W/C				

Table 11. Non-collocated User Permission Details (Continued)

Web Interface Selection	Access Privileges and Restrictions		SW	AM	MA	MA3
SMTP & DNS	ePDU SMTP & DNS parameters configuration	R/W	•	•	•	•
		R/W/C				
Date & Time	ePDU DATE & TIME parameters configuration	R/W	•	•	•	•
		R/W/C				

NOTE Users with Read/Write access rights can change the value of settings, such as the name of outlets and thresholds, but cannot set the following parameters: state on device start-up, switch on after, and power reboot period.

Table 12. Collocated User Permission Details

Web Interface Selection	Access Privileges and Restrictions		SW	AM	MA	MA3
ePDU Overview	ePDU Overview Setting configuration and reset Kwh	Not Permitted	•	•	•	•
ePDU Groups	ePDU Group Setting configuration <small>SEE NOTE 1</small>	R/W	•	•	•	•
		R/W/C				
	ePDU Group switching On/Off	R/W/C	•	—	•	•
ePDU Outlets	ePDU Outlet Setting configuration <small>SEE NOTE 2</small>	R/W	•	•	•	•
		R/W/C				
	ePDU Outlet switching On/Off	R/W/C	•	—	•	•
Power Schedule	ePDU Power Schedule data access for review only	R	•	—	•	•
		R/W				
		R/W/C				
		R/W/C	•	—	•	•
	ePDU Power Schedule configuration	R/W/C	•	—	•	•
	ePDU Power Schedule assignment to users	Not Permitted	•	—	•	•
Email Notification	ePDU Email address data access for review only	R	•	•	•	•
		R/W				
		R/W/C				
		R/W	•	•	•	•
	ePDU Email address configuration	R/W	•	•	•	•
		R/W/C				
	ePDU Email address assignment to users	Not Permitted	•	•	•	•
Access Control	Password Configuration	R/W	•	•	•	•
		R/W/C				

NOTE NOTE 1: A user with only Read/Write access rights is not permitted to change the value of the power reboot period parameter.

NOTE NOTE 2: Users with Read/Write access rights can change the value of settings, such as the name of outlets and thresholds, but cannot set the following parameters: state on device start-up, switch on after, and power reboot period.

Power Schedules for Managed and Switched ePDUs

You can schedule certain automatic operation status changes for outlets or groups of outlets. These are called Power Schedules. Up to eight power schedules are available on the Advanced ePDU.

The operation status changes are called actions. Actions that can be applied for an outlet or outlet group include On, Off, or Reboot. Actions can be scheduled to occur only one time, or to repeat at intervals. The default schedule allows one action per schedule, but you can add a second action to the schedule if desired.



NOTE Although you can set one or more power schedules for the same outlets, a warning message in a popup window will alert you if the outlet is already attached to another user.

If you assign a power schedule to a collocated user, only the outlets or outlet groups that are attached to this user can be scheduled.

Example Power Schedule Configuration

The outlets in this example will be set to automatically power On at six o'clock in the morning and power Off at eight o'clock in the evening during weekdays. The same outlets will also be set to automatically power Off at six o'clock Friday afternoon, remain off during the weekend, and power On Monday morning at six o'clock.

Two power schedules are required to set up this action (Power Schedule 1 and Power Schedule 2). Both are attached to a user named User 1. These power schedule actions will be performed on the Factory Group 2 outlets selected in the Add Outlets panel. The affected outlets are listed in the Selected Outlets panel.

First Schedule. The first example schedule configures a daily schedule to power Off outlets at 8:00 p.m., then power On outlets at 6:00 a.m. the following morning. These are two separate actions and are entered separately on Schedule 1. The frequency of both actions is controlled by the value set in the **Periodic Action(s) every: Day** field. The value is 1 for Schedule 1, which indicates that the actions will be performed once each day.

Figure 37 shows how to use the Power Schedule page on the Web interface to configure the first part of this power schedule.



NOTE You must check the **Add New Action** check box to add a second action to the schedule.

Power Schedule

Select Power Schedule:

Name:

Status:

Attribute this Power Schedule to a User

Add Outlets

Factory Groups

Factory Group 1

Defined Groups

Group 1

Outlets

Selected Outlets

Outlet 1
Outlet 2
Outlet 3
Outlet 4
Outlet 5
Outlet 6
Outlet 7
Outlet 8
Outlet 9
Outlet 10
Outlet 11
Outlet 12

Action:

Date of Next Action: at: (hh:mm) Periodic Action (s) every: Day(s)

Add New Action

Action:

Date of Next Action: at: (hh:mm)

Figure 37. Example First Power Schedule (Schedule 1)

Second Schedule. The second example configures a weekly schedule to power Off outlets at 8:00 p.m. on Friday evening, then power On the outlets at 6:00 a.m. the following Monday morning. These are two separate actions and are entered separately on Schedule 2. The frequency of both actions is controlled by the value set in the **Periodic Action(s) every: Day** field. The value is 7 for Schedule 2, which indicates that the actions will be performed once each week.

Figure 38 shows how to use the Power Schedule page on the Web interface to configure the second part of the power schedule.

NOTE Although the first schedule is set for daily actions, the second power schedule will override the actions of the first power schedule during the weekend. Therefore, the first power schedule will not be executed during the weekend.

The screenshot displays the 'Power Schedule' configuration interface. At the top, 'Select Power Schedule:' is set to 'Power Schedule 2'. Below this, 'Name:' is 'Schedule 2' and 'Status:' is 'Enabled'. A checkbox 'Attribute this Power Schedule to a User' is checked, with 'user1' selected in the dropdown. The 'Add Outlets' section contains three columns: 'Factory Groups' (with 'Factory Group 1'), 'Defined Groups' (with 'Group 1'), and 'Outlets' (with 'Outlet 1' through 'Outlet 12'). The bottom section shows two action entries. The first entry has 'Action:' set to 'Off', 'Date of Next Action:' as '16/03/2012', 'at:' as '20:00', and 'Periodic Action (s) every:' as '7 Day(s)'. The second entry has 'Action:' set to 'On', 'Date of Next Action:' as '19/03/2012', 'at:' as '06:00', and 'Periodic Action (s) every:' as '7 Day(s)'. A checkbox 'Add New Action' is checked.

Figure 38. Example Second Power Schedule (Schedule 2)

Group Definition

A user-defined group consists of outlets that are logically linked on the same ePDU. By associating outlets in a collective group, you can ensure that outlets are turned On, turned Off, and rebooted in a synchronized manner.

Synchronizing group actions through outlet groups provides the following benefits:

- Provides more precise shutdown and restart timing than relying on the delay periods of individual outlets
- Allows you to monitor global consumption by group of outlets
- Allows you to assign specified outlet groups to a user and thereby restrict that user's access only to the assigned groups

For a system that uses outlet groups, the following rules apply:

- A user-defined group must contain at least one outlet.
- An outlet can belong to more than one user-defined group.
- To create and configure a user-defined group, you must use the Web interface.
- The Serial interface does not let you display or configure a user-defined group.
- Only the administrator or a non-collocated user (with at least read/write access) can perform this action.



IMPORTANT

Be aware that if you assign the same outlet to different users with appropriate access privileges, multiple users can power Off the same outlet.

Common Operation Tasks

This section describes common operation tasks.

Download/Upload the Network Management Card File Configuration

The Network Management Card settings are saved as an XML file in the Network Management Card file system. The file is named ConfigurationData.xml.

Downloading the Network Management Card configuration file consists of transferring the Network Management Card configuration file from the Network Management Card to a remote computer. When the download is complete, you can edit the file and modify it before uploading it to the same or another ePDU.

Uploading the Network Management Card configuration file is the opposite process. It consists of transferring the Network Management Card configuration file from a remote computer to the Network Management Card. When the upload is complete, restart the Network Management Card for the new configuration to take effect. (The Web interface displays a message reminder to restart the Network Management Card. See "Restarting the Network Management Card" on page 42 for more information.

Download/Upload the ePDU File Configuration

The ePDU settings are saved as an XML file in the Network Management Card file system. The file is named ConfigurationPdu.xml.

Downloading the Network Management Card configuration file consists of transferring the ePDU configuration file from the Network Management Card to a remote computer. When the download is complete, you can edit the file and modify it before uploading it to the same or to another ePDU.

Uploading the ePDU configuration file is the opposite process. It consists of transferring the ePDU configuration file from a remote computer to the Network Management Card. When the upload is complete, the new settings are immediately applied to the ePDU.

Clear ePDU and Event Log

The Network Management Card logs all the events that occur on the ePDU. The events are classified and logged according to type:

- **ePDU:** Events that occur on the ePDU, including unit, outlet, group, and environment events.
- **SYSTEM:** Events that occur on the Network Management Card, such as connectivity state or restart.

These events are logged in a dedicated comma separated values (CSV) file named "logevent.csv" in the Network Management Card file system.

The Network Management Card manages up to 1000 events. When this limit is reached, the 50 oldest events are deleted. However, a non-located user or administrator can use remote interface functions to manually delete all recorded ePDU or system events.



NOTE

Collocated users only see the event log attached to the outlets assigned to them. However, they cannot clear the logs.



IMPORTANT

When a non-located user or administrator clears all events from the Event Log, events are cleared for all ePDU users, including other users and the administrator.

Refresh the Data Display

Not all data fields automatically refresh, such as the data on the Logs and Alarms pages. To refresh any page that does not have a **Refresh** button, press **F5**.

SNMP Agent Overview

The Network Management Card embeds an SNMP agent. The SNMP agent supports the following SNMP versions:

- SNMPv1
- SNMPv3
- SNMPv1 and v3

The SNMP agent is disabled by default and uses default port 161.



NOTE

The MIB objects are not described in this document. Use a MIB browser tool on a PC for descriptions of the MIB objects and traps with comments.

The SNMP agent implements the SNMP MIB-II and the Eaton MIB. The Eaton MIB files can be downloaded from the ePDU SNMP page on the Web interface (see "Download the Eaton MIB Files" in this section). The files can also be downloaded from the Serial interface.

Get/Set the MIB objects

Read/write access to the MIB objects is ruled by the enabled SNMP version. To get and set the MIB objects:

1. Configure the SNMP version:
 - For the Web interface procedure, see "Enable/Disable the SNMP Agent" on page 96.
 - For the Serial interface procedure, see "SNMP Control" on page 107.

2. If required, configure the SNMPv1 users:
 - For the Web interface procedure, see “Define SNMPv1 Users” on page 96.
 - For the Serial interface procedure, see “SNMP v1 Community” on page 109.
3. If required, configure the SNMPv3 User-based Security Model (USM) users
 - For the Web interface procedure, see “Define SNMPv3 User-based Security Model Users” on page 96.
 - For the Serial interface procedure, see “SNMP V3 USM Table” on page 110

Table 13 summarizes the privileged operations that are allowed according to the SNMP version.

Table 13. Privileged Operations Allowed for SNMP Version

Privilege	Disabled		SNMPv1		SNMPv3		SNMP v1 & v3	
	Get	Set	Get	Set	Get	Set	Get	Set
SNMPv1 User with No Access rights	–	–	–	–	–	–	–	–
SNMPv1 User with Read-Only rights	–	–	•	–	–	–	•	–
SNMPv1 User with Read/Write rights	–	–	•	•	–	–	•	•
SNMPv3 User with No Access rights	–	–	–	–	–	–	–	–
SNMPv3 User with Read-Only rights	–	–	–	–	•	–	•	–
SNMPv3 User with Read/Write rights	–	–	–	–	•	•	•	•

Download the Eaton MIB Files

The files defining the Eaton Simple Network Management Protocol (SNMP) Management Information Base (MIB) supported by the Network Management Card can be downloaded from the Web interface only. The SNMP page provides a hyperlink to a zip archive named EATON-EPDU-MIB.zip. The archive is saved on the PC and stored in the Network Management Card file system.



NOTE This function cannot be performed with the Serial interface. You must use the Web interface.

Actions on Individual Outlets and Groups of Outlets

For Managed and Switched ePDUs, you can control the state of each outlet or groups of outlets.



NOTE Only outlets and groups of outlets with switch capability enabled can respond to Switch On, Switch Off, and Reboot actions.

Switch ON

If the switch capability is enabled for the selected outlet or a group of outlets, you can power on the outlet. An outlet in the OFF state changes to the ON state. The state does not change for outlets already on.

Switch OFF

If the switch capability is enabled for the selected outlet or a group of outlets, you can power off the outlet. An outlet in the ON state changes to the OFF state. The state does not change for outlets already off.

Reboot

If the switch capability is enabled for the selected outlet or a group of outlets, you can reboot the outlet.

If the outlet or group of outlets are initially on, they turn off immediately and turn on again after the delay defined by “Power Reboot Period.”

If the outlet or groups of outlets are initially off, they turn on after the delay defined by “Power Reboot Period.”

Restart the Network Management Card

You can restart the Network Management Card using either a hardware or software method.

For a hardware restart, locate the Reset opening (labeled R) on the ePDU. Insert a probe, press the recessed button, and retract the probe. This method is not necessarily the best choice because the Network Management Card does not force the system to save the parameters in the file system before restarting.

A software restart is triggered from the Serial interface or Web interface upon user action. This method is typically the better choice because the Network Management Card saves all current settings in the Network Management Card file system before restarting.

For either method, restarting the Network Management Card does not restart the ePDU or change the power status of the outlets.

Restore the Default Factory Settings of the Network Management Card

This action consists of overwriting the current Network Management Card settings with the default factory settings. However, if you enable the “Keep IP” option in either remote interface, the following settings are unchanged:

- IPv4 address
- IPv4 gateway address
- IPv4 subnet mask
- IPv6 control
- IPv6 auto-configuration control
- IPv6 address 1
- IPv6 address 2
- IPv6 prefix length 1
- IPv6 prefix length 2
- IPv6 router address
- Ethernet speed/duplex mode

This action does not restart the ePDU or change the power status of the outlets. This action does not change the current threshold configuration for the ePDU settings.

Settings

This section provides descriptions, values, and value ranges for the Network Management Card and ePDU settings. These values and value ranges apply for remote interfaces.



IMPORTANT

The characters “&” or “<” are illegal entries in any of the user interfaces.

Modify Settings

The Web and Serial interfaces and the SNMP agent allow you to modify some Network Management Card and ePDU settings. These settings must be saved permanently in order to preserve the configurations when the ePDU is powered off.

When some settings are changed, they are automatically saved permanently after a 15-second lapse of time without any new setting modification. If the Network Management Card is powered off and restarted from the Reset opening before the 15 seconds have elapsed, the new setting changes will be lost at the next startup.

To ensure settings are saved before the end of the 15-second duration, use the software procedure to restart the Network Management Card (see “Restart the Network Management Card” on page 56).

Network Management Card Settings Table

Table 14 provides Network Management Card parameter settings.Environmental Settings Table.

Table 14. Network Management Card Settings

Name	Description
eMail Receiver Account	E-mail account address. For example, e-mail1@recipient.com. Maximum 63 characters.
eMail Receiver Description	User-defined description. Not used to send an e-mail; only for account identification. Maximum 31 characters.
eMail Receiver State	Default is Disabled: no e-mail is sent to this account. Enabled: this account can receive e-mail (periodic reports or alarms according to the e-mail recipient configuration).
Attached Event Log Control	Default is Disabled: the event log comma-separated values (CSV) file "logevent.csv" is not joined as attachment to alarm e-mail. Enabled: the event log CSV file "logevent.csv" is included as an attachment to alarm e-mail. Not applicable for periodic report e-mail; in this case, the event log is always attached to the e-mail.
Date of Next Report	Day of the month when the next periodic report will be sent. The user has to define this parameter once. When the report #n is sent, this parameter is automatically modified to show the date of report as #n+1. Where: #n+1 = date of report #n + report frequency. 0 (default) disables the periodic report functionality. Examples: Case 1: Current date: 16th of May 2011. Date of next report (#1): 20. Report Frequency: 2 days Report #1 sent on 20th of May 2011 and date of next report becomes 22. Report #2 sent on 22nd of May 2011 and date of next report becomes 24. Report #3 sent on 24th of May 2011 and date of next report becomes 26. Case 2: Current date: 16th of May 2011. Date of next report (#1): 4. Report Periodicity: 14 days. Report #1 sent on 4th of June 2011 and date of next report becomes 18. Report #2 sent on 18th of June 2011 and date of next report becomes 2. Report #3 sent on 2nd of July 2011 and date of next report becomes 16.
Report Periodicity	Defines the duration in days between the first and second e-mailed report. Default is 0: disables the periodic report functionality.
Report Periodicity Time	Defines the time (hour and minute) when the next periodic report must be sent. It must be defined in the range [00:00–23:00]. Default is 00:00.
Alarm Email Control	This setting indicates if e-mail must be sent when an alarm appears. All Alarms: an e-mail is sent when an alarm appears. Default is None: no e-mail is sent when an alarm appears.
Trap Receiver IP address	IPv4/IPv6 address or hostname of the trap receiver. Traps will be sent to this address.

Table 14. Network Management Card Settings (Continued)

Name	Description
Trap Receiver Description	User-defined description. Not used to send a trap; only for receiver identification. Maximum 31 characters.
Trap Receiver Protocol	Defines the SNMP version supported by the receiver. SNMPv1: the trap receiver is enabled and only supports SNMPv1 traps. SNMPv3: the trap receiver is enabled and only supports SNMPv3 traps. Default is Disabled: the trap receiver is disabled. No trap is sent to this receiver.
Trap Control	This setting indicates if traps must be sent when an alarm appears. Default is None: no trap is sent when an alarm appears,
Trap Community	Defines the community supported by the trap receivers. Maximum 31 characters.
System Contact	User-defined contact name. Maximum 31 characters.
System Location	User-defined device location. Maximum 31 characters.
Firmware Upgrade Control	Indicates if the firmware upgrade functionality can be used. Disabled: the firmware upgrade functionality is not supported. Default is Enabled: the firmware upgrade functionality is supported.
Keep IP Option	Indicates if the IP settings must be kept unchanged when the user performs a default factory reset of the Network Management Card. Default is Disabled.
Ethernet Link Speed & Duplex	Defines the Ethernet Link Speed and Duplex mode as follows: <ul style="list-style-type: none"> • Auto Negotiation (auto configuration - default) • 100 Mbps Full Duplex • 100 Mbps Half Duplex • 10 Mbps Full Duplex • 10 Mbps Half Duplex
DHCP Control	Indicates if the IPv4 is dynamically assigned by a DHCP server on the LAN. Disabled: the Network Management Card uses a static IPv4 address. Default is Enabled: the IPv4 address is dynamically assigned by a DHCP server on the LAN.
IPv4 Address	IPv4 Address of the Network Management Card. When the DHCP control is enabled, this address is dynamically assigned by a DHCP server on the LAN. In this case, the user cannot modify it manually. Default is 192.168.123.123.
IPv4 Subnet Mask	IPv4 Subnet Mask of the Network Management Card. When the DHCP control is enabled, this Subnet Mask is dynamically assigned by a DHCP server on the LAN. In this case, the user cannot modify it manually. Default is 225.225.0.0.
IPv4 Gateway Address	IPv4 address of the gateway on the LAN. When DHCP control is enabled, this address is dynamically assigned by a DHCP server on the LAN. In this case, the user cannot modify it manually.
Hostname	Network Management Card host name. This setting is sent in the DHCP request when the DHCP is enabled. If the DHCP server is coupled with a DNS server, the user can access the ePDU Web interface by using this host name instead of the IP address. Maximum 31 characters. Default is ePDUxy. Where: xy = the two last digits of the MAC address.
IPv6 Control	Indicates if the IPv6 interface is enabled. Enabled: the Network Management Card is accessible with an IPv6 address. Default is Disabled: the Network Management Card is not accessible with an IPv6 address.

Table 14. Network Management Card Settings (Continued)

Name	Description
IPv6 Local Address	IPv6 Local Address.
IPv6 Auto Configuration Control	Indicates how the IPv6 addresses are configured. Enabled: the IPv6 addresses (local and global) and prefix lengths are auto-configured. Default is Disabled: the IPv6 addresses (local and global) and prefix lengths are manually configured by the user.
IPv6 Global Address 1	IPv6 Global Address 1.
IPv6 Prefix Length 1	Prefix length associated with the IPv6 Global Address 1. This value must be in the range [0–128].
IPv6 Global Address 2	IPv6 Global Address 2.
IPv6 Prefix Length 2	Prefix length associated with the IPv6 Global Address 2. This value must be in the range [0–128].
IPv6 Gateway Address	IPv6 address of the gateway on the LAN.
Super User Login	Super User Login. Maximum 15 characters. Default is admin.
Super User Password	Super User Password. Maximum 15 characters. Minimum 5 characters. Default is admin.
Telnet Control	Indicates if the Telnet interface is accessible. Enabled: the Telnet interface is accessible. Default is Disabled: the Telnet interface is not accessible.
HTTP Control	Indicates if the Web interface is accessible. Disabled: the Web interface is accessible. Default is Enabled: the Web interface is not accessible.
SSL Control	Indicates if the Secure Sockets Layer (SSL) encryption is enabled for the Web interface. Enabled: the Web interface is with SSL encryption (use https://IP_address). Default is Disabled: the Web interface is without SSL encryption (use http://IP_address).
Multi-User Login	Multi-User Login. Maximum 15 characters.
Multi-User Password	Multi-User Password Maximum 15 characters. Minimum 5 characters.
Multi-User Security Level	It indicates the rights allowed to the user among: No access: the user cannot log in the web interface Read-only: the user can access the web interface but without the capability to change configurations, control devices, delete data, or use transfer options Read/write: the user can access the web interface and modify the settings, but without the capability to switch on/off the outlets Read/Write/control: the user can access the web interface, modify the settings and switch on/off the outlets
SMTP Server	IPv4 or IPv6 or host name of the SMTP server to use to send e-mail.
SMTP Server Authentication Control	Indicates if the SMTP server requires authentication to connect to it. Enabled: an authentication is required. The optional user-defined login and password are used to authenticate. Default is Disabled: no authentication is required.
Optional SMTP Server Login	Optional login parameter to authenticate on the SMTP server. Maximum 31 characters.

Table 14. Network Management Card Settings (Continued)

Name	Description
Optional SMTP Server Password	Optional password parameter to authenticate on the SMTP server. Maximum 31 characters. Minimum 5 characters.
Sender Address	Address that appears as sender field of the e-mail sent by the ePDU. Maximum 31 characters. Default is ePDU@eaton.com.
Primary DNS server	IPv4 or IPv6 address of the primary DNS server.
Secondary DNS server	IPv4 or IPv6 address of the secondary DNS server.
SNMP version	Indicates the version of the operating SNMP agent. SNMPv1: the SNMP agent only supports SNMPv1, SNMPv3: the SNMP agent only supports SNMPv3, SNMPv1 & v3: the SNMP agent supports SNMPv1 and SNMPv3. Default is Disabled: the SNMP agent is not started.
SNMPv1 Community name	User-defined SNMPv1 community name. Maximum 26 characters.
SNMPv1 Community Security Level	Indicates the rights allowed to the SNMPv1 community. Read-only: the SNMP agent only accepts the GET commands for this community. Read/write: the SNMP agent accepts the GET and SET commands for this community. Default is No access: the SNMP agent rejects user using this community.
SNMPv3 USM User Name	User-defined SNMPv3 User-based Security Model (USM) user name. Maximum 31 characters.
SNMPv3 USM User Access Rights	Indicates the rights allowed to the SNMPv3 USM user. Read-only: the SNMP agent only accepts the GET commands for this user. Read/write: the SNMP agent accepts the GET and SET commands for this user. Default is No access: the SNMP agent rejects the user.
SNMPv3 USM User Security Level	Indicates the authentication required by the SNMP agent to accept the request from this user. No Auth No Priv: no authentication password and no privacy key is required by the SNMP agent. Auth No Priv: an authentication password is required but no privacy key is required by the SNMP agent. Auth Priv: an authentication password and a privacy key are required by the SNMP agent. Default is Not Set: the SNMP agent rejects the user.
SNMPv3 USM User Authentication Password	User-defined authentication password. The authentication mechanism is based on MD5 encryption only. Only required if the security level is Auth No Priv or Auth Priv. Maximum 24 characters. Minimum 8 characters.
SNMPv3 USM User Privacy key	User-defined privacy key. The authentication mechanism is based on DIGEST-MD5 encryption only. Only required if the security level is Auth Priv. Maximum 24 characters. Minimum 8 characters.
Date Format	Indicates how the date must be displayed as follows: <ul style="list-style-type: none"> • dd/mm/yyyy (default) • mm/dd/yyyy • yyyy - mm - dd • dd mm yyyy
Time Synchronization Source	Indicates the time source. Values are: Dynamically Configured by the NTP server. Default is Manually Configured by user.
NTP Server	IPv4 or IPv6 or hostname of the NTP server to use for time synchronization. Not applicable for manual time synchronization. Maximum 63 characters.

Table 14. Network Management Card Settings (Continued)

Name	Description
Date	ePDU date. This setting cannot be manually configured if the Time Synchronization Source is an NTP server.
Time	ePDU time. This setting cannot be manually configured if the Time Synchronization Source is an NTP server.
Time Zone	Time zone to use when the time synchronization is done by an NTP server. Not applicable for manual time synchronization. Default is Greenwich Mean Time.
Daylight Saving Time Option	Indicates if the Daylight Saving Time option must be applied when the time synchronization with NTP server is used. Enabled: the summer/winter hour correction is applied to the time synchronization returned by the NTP server. Default is Disabled: the summer/winter hour correction is not applied to the time synchronization returned by the NTP server.
IPv6 status	Indicates the status of the IPv6 configuration/addresses. Invalid: the IPv6 addresses are not valid. Valid: the IPv6 addresses are valid and can be used to access the Network Management Card. Manual Configuration: the IPv6 addresses are manually configured and can be used to access the Network Management Card.
eMail attached user	It indicates the user to whom this e-mail address is attached.
User attached Groups	The list of the groups to which a user has access. Only the administrator can attach groups to users. If the administrator attaches groups to a user, they are considered to be collocated. Otherwise, the user is considered to be non-collocated, a security level that allows Read/Write access.
Power schedule name	The name of the Power Schedule. Max 31 characters.
Power schedule state	Whether the power schedule is Enabled or Disabled (default). By default, the actions are not executed.
Power schedule attached user	The user to whom the power schedule is attached. If the user is collocated, only outlets attached to this user can be scheduled.
Factory groups list	The list of all factory groups. For a collocated user, only the factory groups only outlets attached to this user are displayed.
User defined groups list	The list of the configured user defined groups. For a collocated user, only the user-defined groups only outlets attached to this user are displayed.
Outlets list	The list of outlets. For a collocated user, only the outlets only outlets attached to this user are displayed.
Selected Outlets	The list of outlets on which the power scheduled will be performed.
Action1	Action 1 is an outlet operation set to repeat automatically based on a user-defined power schedule. An action can be defined as an outlet power On, power Off, or Reboot. The action will be performed on the selected outlets. <ul style="list-style-type: none"> • Set time and periodicity (frequency) of the action. • Set date on which the action will start. <p>NOTE Two actions can be set per schedule. The first action (Action1) is mandatory. The second action (Action2) is optional.</p>

Table 14. Network Management Card Settings (Continued)

Name	Description
Date First action of the power schedule	Indicates the day (date, hour and minute) of the execution of the first action.
Periodicity of the power schedule	Defines the time (hour and minute) when the two actions (action one and, if configured, action two) must be executed.
Action2	<p>Action 2 is an outlet operation set to repeat automatically based on a user-defined power schedule. An action can be defined as an outlet power On, power Off, or Reboot. The action will be performed on the selected outlets.</p> <ul style="list-style-type: none"> • Disabled by default; must be enabled to configure • Will be executed on the same outlets as the first action. • Must select a date later than the date selected for the first action. <p>NOTE Periodicity is the same as set for the first action.</p>

Table 15 provides settings for the Environmental Monitoring Probe (EMP).

Table 15. Environment Settings

Name	Description
Temperature Unit	<p>The user can define the temperature unit as follows:</p> <ul style="list-style-type: none"> • °F • °C (default)
Temperature High Warning Threshold	<p>High warning threshold for the temperature. The unit of this setting is defined by the temperature unit setting. In the range 0°C–70°C (32°F–158°F). Temperature High Warning Threshold < Temperature High Critical Threshold. Default is 50°C (122°F).</p> <p>If the measurement exceeds this limit:</p> <ul style="list-style-type: none"> • An alarm is set • Traps are sent to configured receivers • E-mail is sent to configured receivers • The high warning icon is displayed near the measurement value in the Web interface
Temperature High Critical Threshold	<p>High critical threshold for the temperature. The unit of this setting is defined by the temperature unit setting. In the range 0°C–70°C (32°F–158°F). Temperature High Critical Threshold > Temperature High Warning Threshold. Default is 80°C (176°F).</p> <p>If the measurement exceeds this limit:</p> <ul style="list-style-type: none"> • An alarm is set • Traps are sent to configured receivers • E-mail is sent to configured receivers • The high critical icon is displayed near the measurement value in the Web interface

Table 15. Environment Settings (Continued)

Name	Description
Humidity High Warning Threshold	<p>High warning threshold for the humidity (measured in percent). In the range [0%–100%]. Default is 65%. Humidity High Warning Threshold < Humidity High Critical Threshold.</p> <p>If the measurement exceeds this limit:</p> <ul style="list-style-type: none"> • An alarm is set • Traps are sent to configured receivers • E-mail is sent to configured receivers • The high warning icon is displayed near the measurement value in the Web interface
Humidity High Critical Threshold	<p>High critical threshold for the humidity (measured in percent). In the range [0%–100%]. Default is 90%. Humidity High Critical Threshold > Humidity High Warning Threshold.</p> <p>If the measurement exceeds this limit:</p> <ul style="list-style-type: none"> • An alarm is set • Traps are sent to configured receivers • E-mail is sent to configured receivers • The high critical icon is displayed near the measurement value in the Web interface
Dry Contact Name	<p>User-defined friendly name. Maximum 31 characters. Default is Contact x Where x = the contact number</p>
Dry Contact Alarm Control—Open state	<p>Indicates if an alarm must be set when the dry contact is in the open state. Informational: no alarm is set when the dry contact is open. Alarm: an alarm is set when the dry contact is open. The active alarms presence icon is displayed near the dry contact state.</p>
Dry Contact Alarm Control—Closed state	<p>Indicates if an alarm must be set when the dry contact is in the closed state. Informational: no alarm is set when the dry contact is closed. Alarm: an alarm is set when the dry contact is closed. The active alarms presence icon is displayed near the dry contact state.</p>

ePDU Settings Table

Table 16 provides ePDU parameter settings.

Table 16. ePDU Settings

Name	Description
ePDU Friendly Name	User-defined friendly name of the ePDU to identify it throughout the LAN. Maximum 31 characters. Default is ePDU.
Phase Current High Warning Threshold	High warning threshold for the phase current in A. In the range [0–655]. Phase Current High Warning Threshold < Phase Current High Critical Threshold. If the measurement exceeds this limit: <ul style="list-style-type: none"> • An alarm is set • Traps are sent to configured receivers • E-mail is sent to configured receivers • The high warning icon is displayed near the measurement value in the Web interface
Phase Current High Critical Threshold	High critical threshold for the phase current in A. In the range [0–655]. Phase Current High Critical Threshold < Phase Current High Warning Threshold. If the measurement exceeds this limit: <ul style="list-style-type: none"> • An alarm is set • Traps are sent to configured receivers • E-mail is sent to configured receivers • The high critical icon is displayed near the measurement value in the Web interface
Phase Voltage Low Warning Threshold	Low warning threshold for the phase voltage in V. In the range [0–655]. Phase Voltage Low Warning Threshold < Phase Voltage Low Warning Threshold. If the measurement is under this limit: <ul style="list-style-type: none"> • An alarm is set • Traps are sent to configured receivers • E-mail is sent to configured receivers • The high warning icon is displayed near the measurement value in the Web interface
Phase Voltage High Warning Threshold	High warning threshold for the phase voltage in V. In the range [0–655]. Phase Voltage High Warning Threshold < Phase Voltage High Critical Threshold. If the measurement exceeds this limit: <ul style="list-style-type: none"> • An alarm is set • Traps are sent to configured receivers • E-mail is sent to configured receivers • The high warning icon is displayed near the measurement value in the Web interface
Phase Voltage High Critical Threshold	High critical threshold for the phase voltage in V. In the range [0–655]. Phase Voltage High Critical Threshold < Phase Voltage High Warning Threshold. If the measurement exceeds this limit: <ul style="list-style-type: none"> • An alarm is set • Traps are sent to configured receivers • E-mail is sent to configured receivers • The high critical icon is displayed near the measurement value in the Web interface

Table 16. ePDU Settings (Continued)

Name	Description
Outlet Friendly Name	User-defined friendly name of an outlet. Maximum 31 characters. Default is "Outlet x" Where x = the outlet number
Outlet Switching Control	Indicates if the outlet state can be changed. Disabled: the outlet state cannot be changed. Enabled: the outlet state can be changed. The supported actions are: ON, OFF, and REBOOT.
Outlet State on ePDU Startup	Indicates the state of the outlet when the ePDU is powered ON. ON: the outlet is powered after a duration defined by the Outlet Switch ON Delay. OFF: the outlet is not powered. Last Known State: the outlet is powered on if it was in the ON state when the ePDU was powered off. Otherwise, the outlet is not powered.
Outlet Switch ON Delay	Indicates when the outlet will be powered On after the ePDU is powered On. It has a duration in seconds. If the setting of the Outlet State upon ePDU startup is On: <ul style="list-style-type: none"> • 0 means that the outlet is immediately powered after the ePDU is powered On. • 10 means that the outlet will be powered 10 seconds after the ePDU is powered On.
Outlet Power Reboot Period	Defines the duration that rules the reboot functionality. This is the duration during which the outlet stays Off before switching On. NOTE Setting a value less than five seconds may allow some traps #33 (Outlet State change) to be lost.
Outlet Current High Warning Threshold	High warning threshold for the outlet current in A. In the range [0–655]. Outlet Current High Warning Threshold < Outlet Current High Critical Threshold. If the measurement exceeds this limit: <ul style="list-style-type: none"> • An alarm is set • Traps are sent to configured receivers • E-mail is sent to configured receivers • The high warning icon is displayed near the measurement value in the Web interface
Outlet Current High Critical Threshold	High critical threshold for the outlet current in A. In the range [0–655]. Outlet Current High Critical Threshold < Outlet Current High Warning Threshold. If the measurement exceeds this limit: <ul style="list-style-type: none"> • An alarm is set • Traps are sent to configured receivers • E-mail is sent to configured receivers • The high critical icon is displayed near the measurement value in the Web interface
Outlet Voltage Low Warning Threshold	Low warning threshold for the outlet voltage in V. In the range [0–655]. Outlet Voltage Low Warning Threshold < Outlet Voltage High Warning Threshold. If the measurement exceeds this limit: <ul style="list-style-type: none"> • An alarm is set • Traps are sent to configured receivers • E-mail is sent to configured receivers • The low warning icon is displayed near the measurement value in the Web interface

Table 16. ePDU Settings (Continued)

Name	Description
Outlet Voltage High Warning Threshold	<p>High warning threshold for the outlet voltage in V. In the range [0–655].</p> <p>Outlet Voltage High Warning Threshold < Outlet Voltage High Critical Threshold.</p> <p>If the measurement exceeds this limit:</p> <ul style="list-style-type: none"> • An alarm is set • Traps are sent to configured receivers • E-mail is sent to configured receivers • The high warning icon is displayed near the measurement value in the Web interface
Outlet Voltage High Critical Threshold	<p>High critical threshold for the outlet voltage in V. In the range [0–655].</p> <p>Outlet Voltage High Critical Threshold < Outlet Voltage High Warning Threshold.</p> <p>If the measurement exceeds this limit:</p> <ul style="list-style-type: none"> • An alarm is set • Traps are sent to configured receivers • E-mail is sent to configured receivers • The high critical icon is displayed near the measurement value in the Web interface
Group Friendly Name	<p>User-defined friendly name of a group.</p> <p>Max 31 characters.</p> <p>Default is "Factory Group x," where x is the outlet number.</p>
Group Power Reboot Period	<p>Defines the duration that rules the reboot functionality. This is the duration during which the outlets of the group stay Off before switching On.</p> <p>NOTE If this period is defined with a value less than five seconds, some traps #33 (Outlet State change) may be lost.</p> <p>NOTE Saving this setting will overwrite the Outlet Power reboot Period value defined for each outlet of the group.</p>
Group Current Low Warning Threshold	<p>Low warning threshold for the group current in A. In the range [0–655].</p> <p>Group Current Low Warning Threshold < Group Current High Warning Threshold.</p> <p>If the measurement exceeds this limit:</p> <ul style="list-style-type: none"> • An alarm is set • Traps are sent to configured receivers • E-mail is sent to configured receivers • The low warning icon is displayed near the measurement value in the Web interface
Group Current High Warning Threshold	<p>High warning threshold for the group current in A. In the range [0–655].</p> <p>Group Current High Warning Threshold < Group Current High Critical Threshold.</p> <p>If the measurement exceeds this limit:</p> <ul style="list-style-type: none"> • An alarm is set • Traps are sent to configured receivers • E-mail is sent to configured receivers • The high warning icon is displayed near the measurement value in the Web interface

Table 16. ePDU Settings (Continued)

Name	Description
Group Current High Critical Threshold	High critical threshold for the group current in A. In the range [0–655]. Group Current High Critical Threshold < Group Current High Warning Threshold. If the measurement exceeds this limit: <ul style="list-style-type: none"> • An alarm is set • Traps are sent to configured receivers • E-mail is sent to configured receivers • The high critical icon is displayed near the measurement value in the Web interface
User Defined Group Friendly Name	User-defined friendly name of a group. Max 31 characters. Default is "Group x," where x is the outlet number.
User Defined Group Status	Status of the user-defined group A disabled user-defined group is not displayed the on the ePDU Group page.
Power Schedule Outlets	List of the power schedule's outlets The list of the outlets attached to the user-defined group.

Starting the ePDU

The Eaton Advanced ePDUs have no power switch. To start up the ePDU:

1. For ePDUs with detachable power cords: If the power cord is not connected, connect the power cord to the ePDU, then connect the power cord to a power source. Otherwise, go to Step 2.



NOTE 1 Plug the ePDU into an appropriately rated outlet for its type.

NOTE 2 Do not replace or rewire the power cord.

2. Verify all circuit breakers are in the ON position.



IMPORTANT

On models rated over 16A (Europe) / 20A (US), fully shrouded branch circuit breakers prevent accidental operation. To power cycle the Eaton ePDU, remove the power cord from the power source and then plug it back in.

Shutting Down the ePDU

To shut down the ePDU:

1. Shut down the connected devices according to the manufacturer's recommended shutdown sequence.
2. Turn each circuit breaker to the OFF position.
3. To remove power from the ePDU completely, disconnect the ePDU power cord from the power source.

Chapter 6 LCD Operation

This chapter contains information on how to use the Eaton Advanced Enclosure Power Distribution Unit (ePDU), including:

- LCD panel and control button functions
- Menu selections



NOTE The LCD panel language is not configurable. Only English is provided.

LCD Panel and Control Buttons

The ePDU has a three-button, graphical LCD panel (see Figure 39). Use the control buttons to change the screen display and retrieve specific performance data or change configuration values.

The display view can also change automatically. For example, the display changes to show active alarms as they occur, or particular displays update due to a change in operating state.

Inactivity can cause a screen change as well. For example, the display returns to the ePDU Input Status screen automatically when no button has been pressed for 15 minutes.

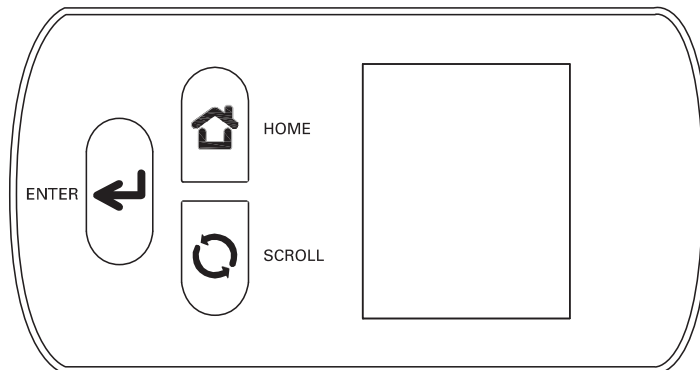

Figure 39. LCD Panel

Operation Mode

Table 17 summarizes how to use the control buttons.

Table 17. Control Buttons

Button	When in Screensaver mode	When in Settings mode
Home	Locks the screen on the current display. Pressing Home goes to the Home page or previous menu (fast push).	Displays the previous menu.
Home (press and hold for one second)	Restarts the Screensaver cycling display.	Restarts the Screensaver cycling display.
Home (press and hold for three seconds)	Turns the backlight OFF (Energy Saving mode). Pressing any button turns the backlight ON.	—
Enter	Displays the Main Menu (Settings mode).	Enters or validates the displayed information. On information screens, this button has no action.

Table 17. Control Buttons (Continued)

Button	When in Screensaver mode	When in Settings mode
Scroll	Locks the screen on the current display. Pressing Scroll again cycles DOWN to the next Screensaver screen.	Scrolls down to the next selection or value. On information screens, this button displays the next screen.
Scroll (press and hold for one second or longer)	Fast scroll down.	Fast scroll down.

NOTE Use the Home button and the Scroll button to enter the password to unlock the LCD.

Screensaver Cycling Sequence

There are three screensaver cycle sequences:

- Single-phase
- Three-phase wye configuration
- Three-phase delta configuration



NOTE See “Three-Phase Configurations” on page 37 for a description of three-phase configuration topologies (wye and delta).

Single-Phase Screensaver Cycle

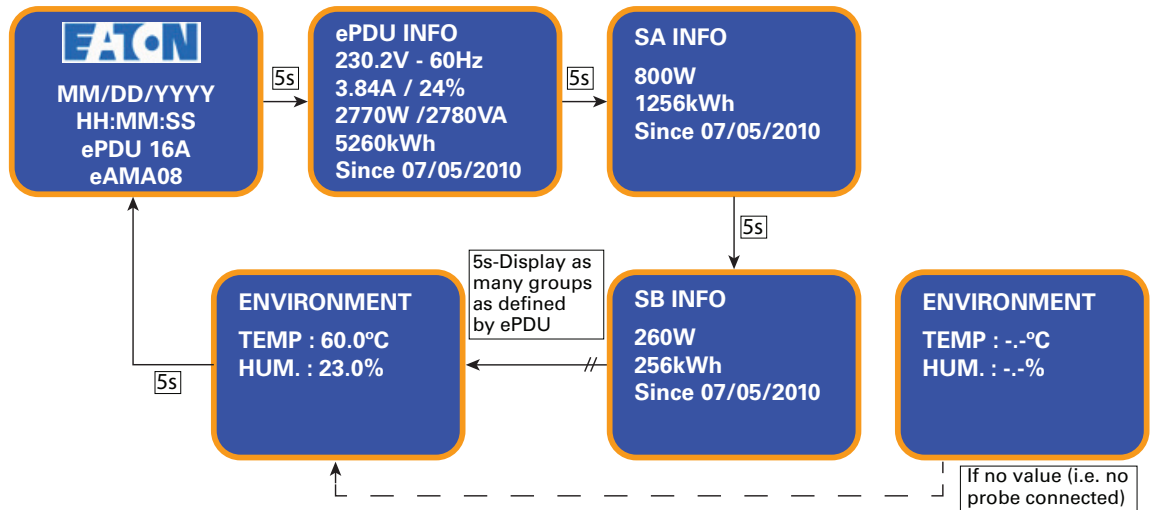

Figure 40. Single-Phase Screensaver Cycle

Wye-configured Three-Phase Screensaver Cycle

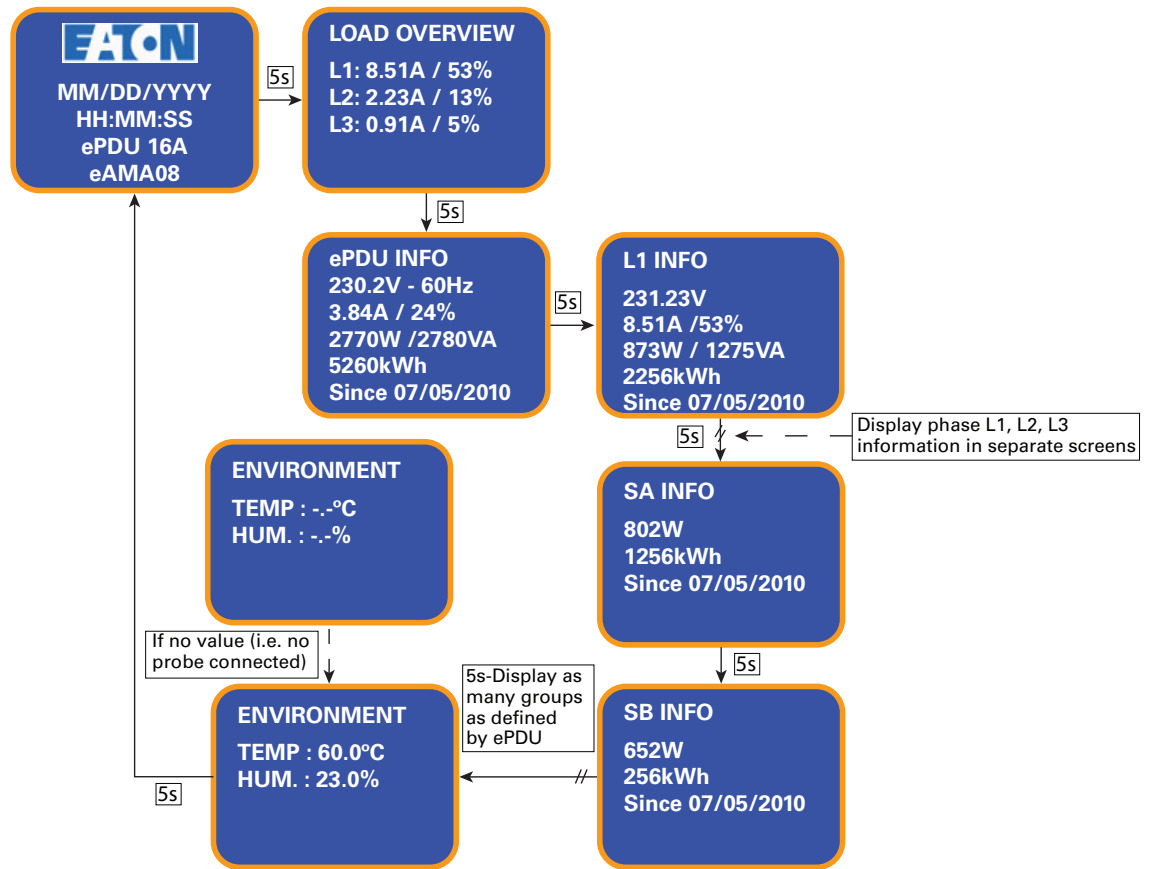

Figure 41. Three-Phase Wye-configured Screensaver Cycle

Delta-configured Three-Phase Screensaver Cycle

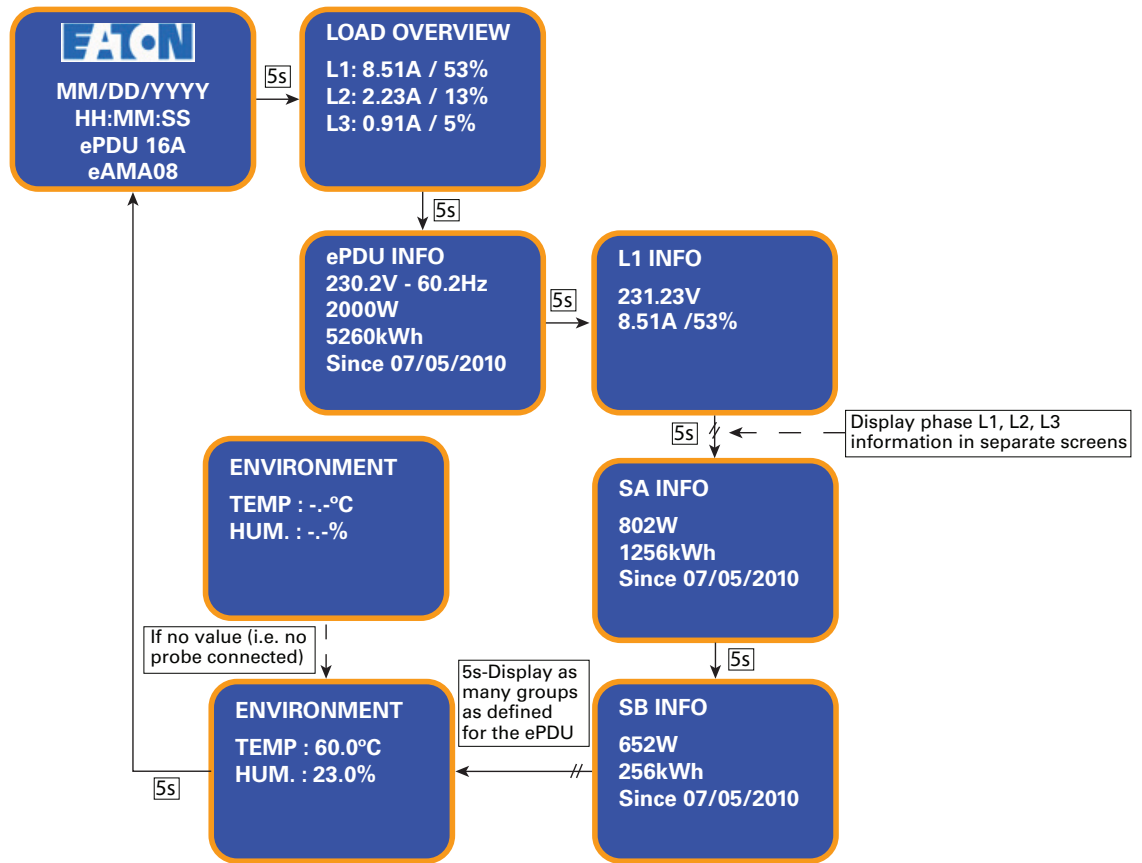

Figure 42. Three-Phase Delta-configured Screensaver Cycle

Locked Screen

A lock appears on a screen to indicate that a password is required to continue (see Figure 43).



Figure 43. Locked Screen

Lock 1 and Lock 2 Passwords

There are two levels of protection within the ePDU menu paths:

- **Display (Lock 1):** You cannot get access to any information except the HOME screen until you enter the required password.
- **Settings (Lock 2):** You can have access to ePDU LCD readings, but cannot enter settings, such as reset to defaults or clear log.



NOTE

The LCD option does not allow you to change or update the password. It is a key that is embedded in the firmware and must be shared at the user's discretion.

Lock passwords are defined as follows:

- Lock 1 = 1234
- Lock 2 = 4321



IMPORTANT

Use the **Home** button (up) and **Scroll** button (down) to select the lock password numbers.

Startup Screen

When the ePDU powers up, the Startup screen displays (see Figure 44).



Figure 44. Startup Screen

Main Menu Selections

The ePDU menu selection hierarchy provides useful performance information, alarms, ePDU identification, and configuration settings. Make a selection from the ePDU Main Menu (see Figure 45).

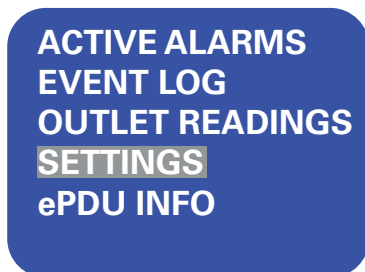

Figure 45. Main Menu Selections

The available menu functions depend on the model type. The Advanced Monitored (AM) and Managed (MA) menu structures are the same (see Figure 46). The Switched (SW) menu structure is slightly different because the SW menu does not contain an Outlet Readings selection path.



NOTE

Lock 1 (display lock) and Lock 2 (settings lock) in Figure 46 and Figure 47 illustrate which lock password should be entered if the Input Password screen displays. See “Lock 1 and Lock 2 Passwords” on page 72.

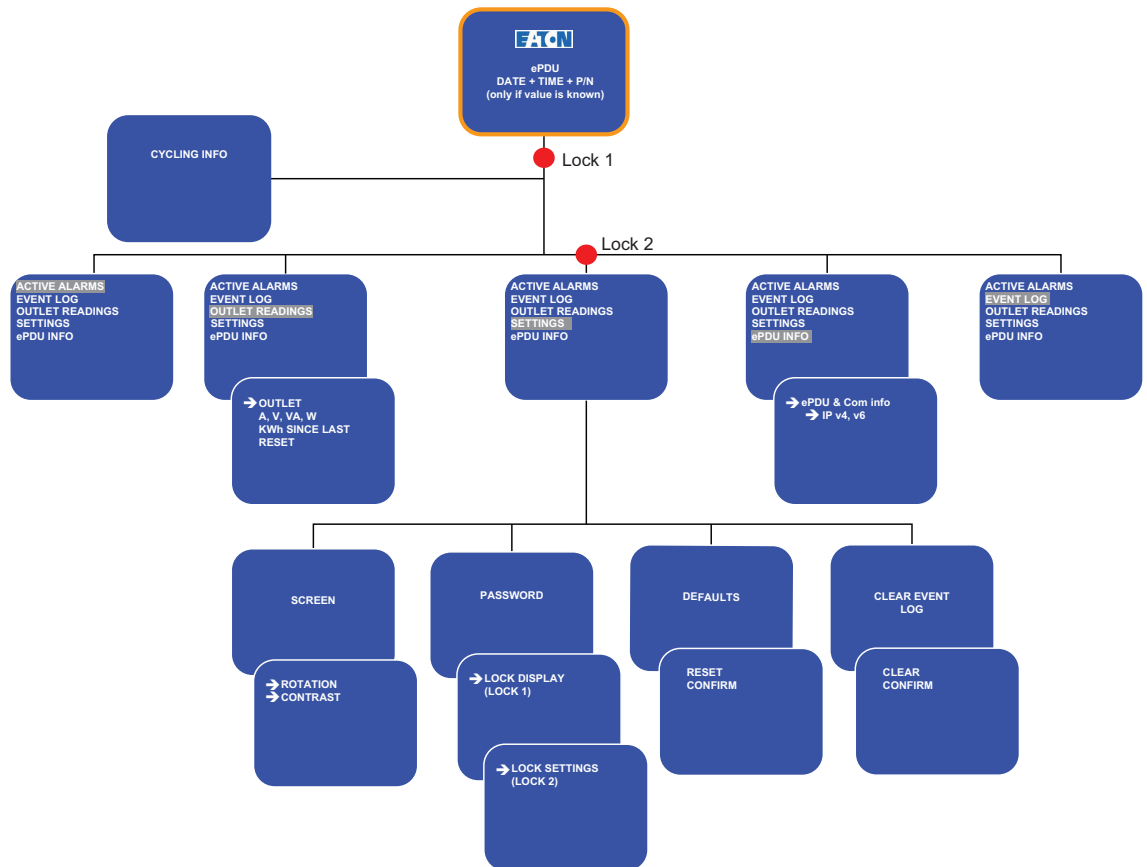

Figure 46. AM and MA Menu Structure

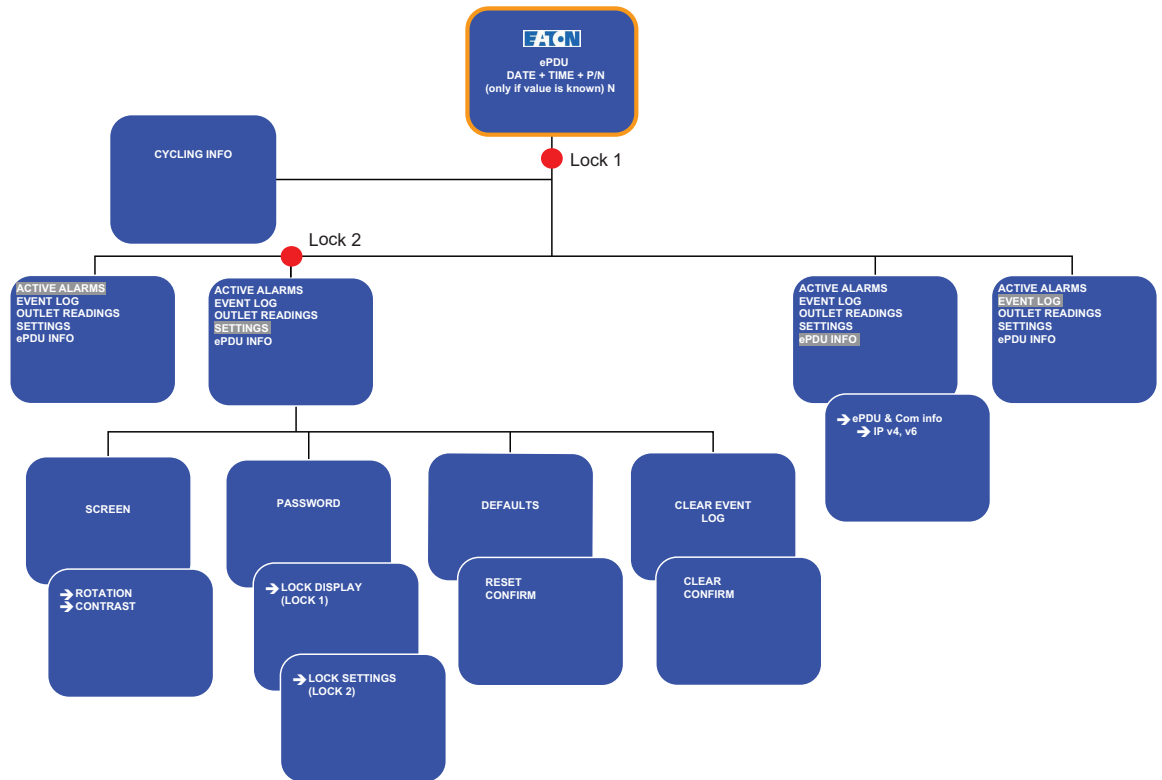

Figure 47. SW Menu Structure

Active Alarms Menu

The Active Alarms menu filters and displays only active alarms for the ePDU (see Figure 48).



Figure 48. Example Active Alarm Displays

Event Log Menu

The Event Log menu holds up to 50 events and most notices. They are logged when they occur. You can scroll through the event screens, beginning with the most recent event.

The first row contains the type of event and code. Each event screen contains the date (*MM/DD/YYYY*) and time (*hh:mm:ss*) when the event occurred. The bottom center of the event screen displays the ordering number of the event in the log, followed by the total number of events in the log (see Figure 49).

If there are no events in the log, the screen displays “No events in log.”

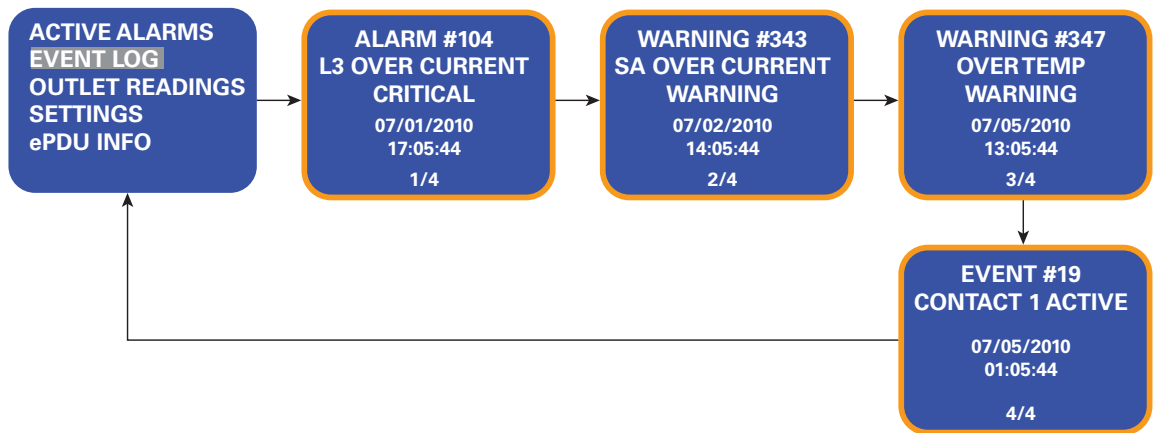

Figure 49. Example Event Log Displays

Outlet Readings Menu

The Outlet Readings menu provides a series of screens the display operational data for a selected outlet. The data includes voltage, current, active power, apparent power, and kilowatt hours (kWh), (see Figure 50).

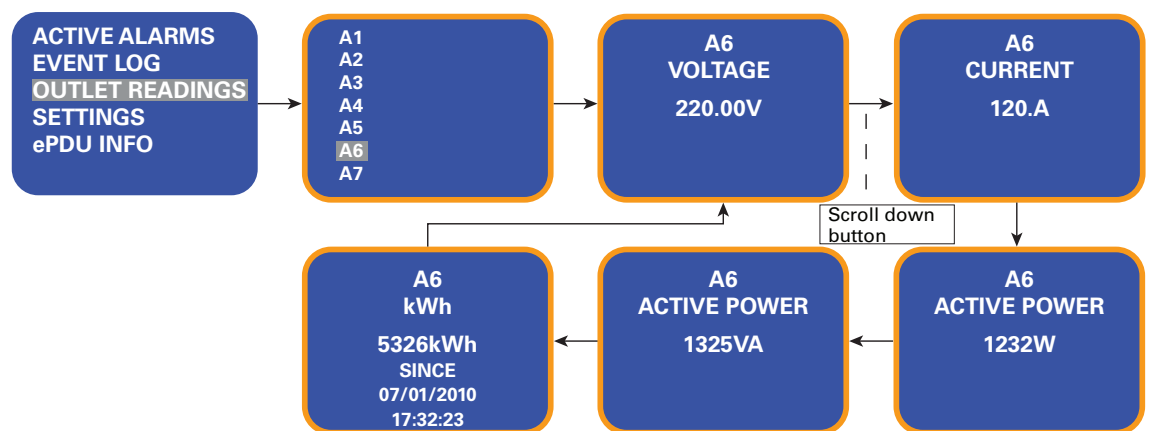

Figure 50. Example Outlet Readings Displays

Settings Menu

The Settings menu provides user configuration options (see Figure 52). Only the available options display, depending on the assigned user privileges (see “Locked Screen” on page 71).

See “Settings” starting on page 56 for the Network Management Card, ePDU, and Environment settings available through the ePDU interface.

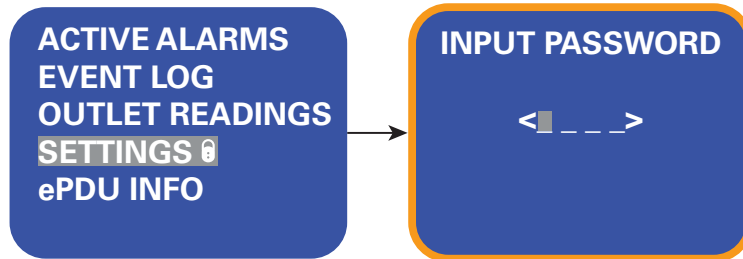

Figure 51. Password Protected Settings Displays

There are four available categories of setting options:

- Screen
- Password
- Clear Event Log
- Defaults

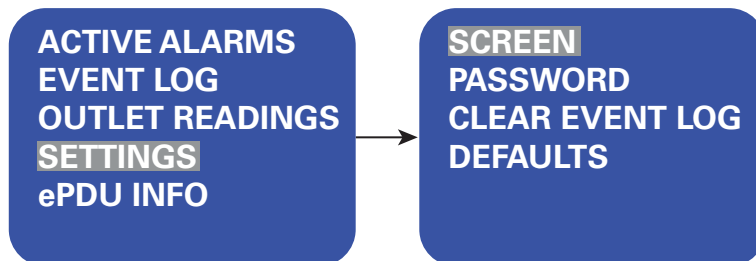

Figure 52. Example Settings Displays

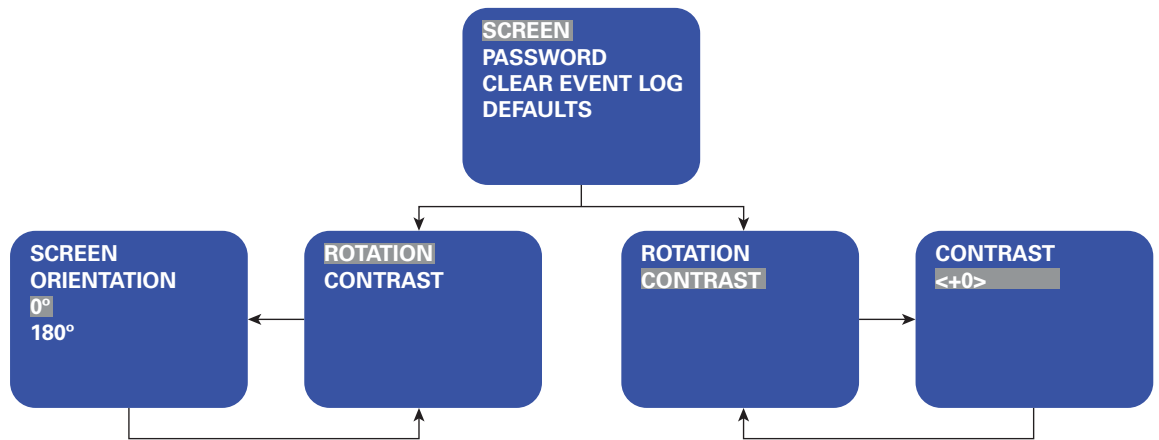

Figure 53. Example Screen Submenu Displays

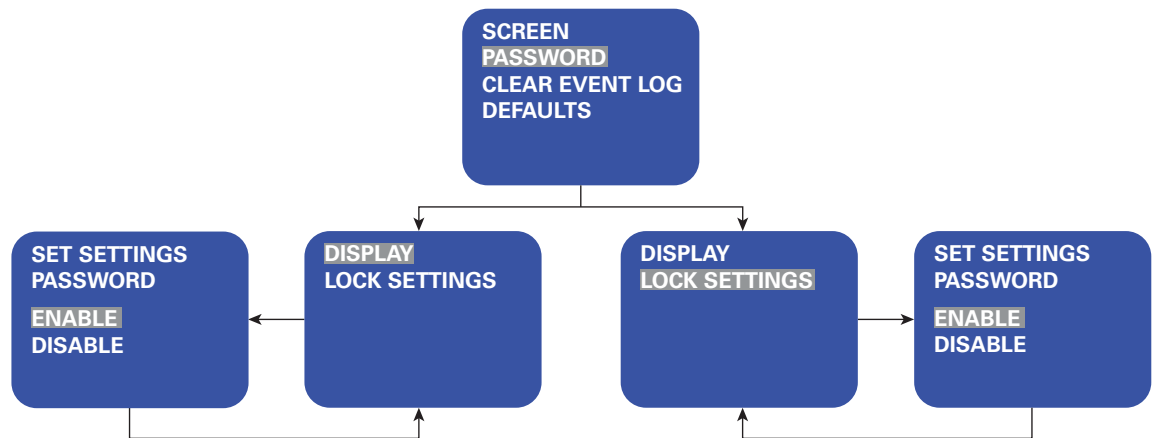

Figure 54. Example Password Submenu Displays



Figure 55. Example Clear Event Log Submenu Displays



Figure 56. Example Defaults Submenu Displays

ePDU Info Menu

The ePDU Info menu provides identification information for this ePDU. The identification information includes the model type, serial number, the ePDU and Network Management Card version numbers, IP addresses, and Network Management Card Media Access Control (MAC) address (see Figure 57).

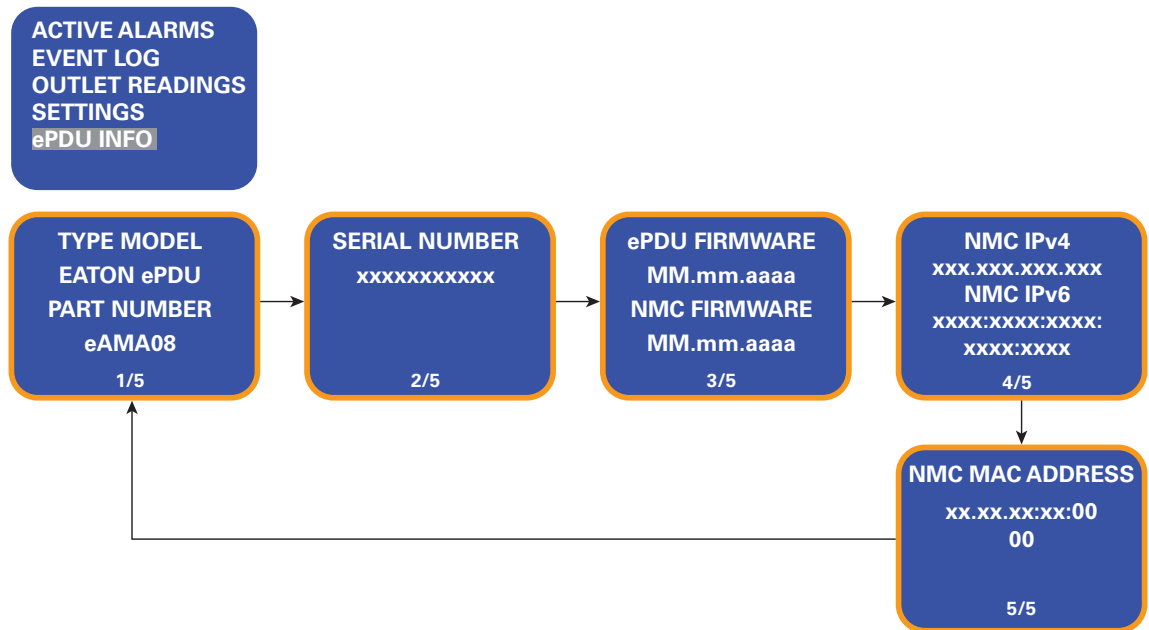

Figure 57. Example ePDU Info Display

Chapter 7 Web Interface Operation

This chapter describes configuring and monitoring an Eaton Advanced Enclosure Power Distribution Unit (ePDU) remotely through the ePDU Network Management Card Web interface. This chapter describes the following:

- Navigating the Web interface
- Accessing the Web interface
- Configuring administration settings
- Configuring attributes
- Configuring network access and control
- Monitoring and managing the ePDU

NOTE 1 The Web interface language is not configurable. Only English is provided.



NOTE 2 The data that displays on the Web interface depends on the ePDU model you are using. The examples shown represent typical data displays reported from a single model.

NOTE 3 The Web interface supports Microsoft Internet Explorer 6.0 and greater, Firefox 3.6 and greater, and Google Chrome 4 and greater.

Navigating the Web Interface

The ePDU Network Management Card Web interface is a graphical Web interface used to remotely monitor or configure the ePDU (see Figure 58). This section describes the functions provided by this interface.

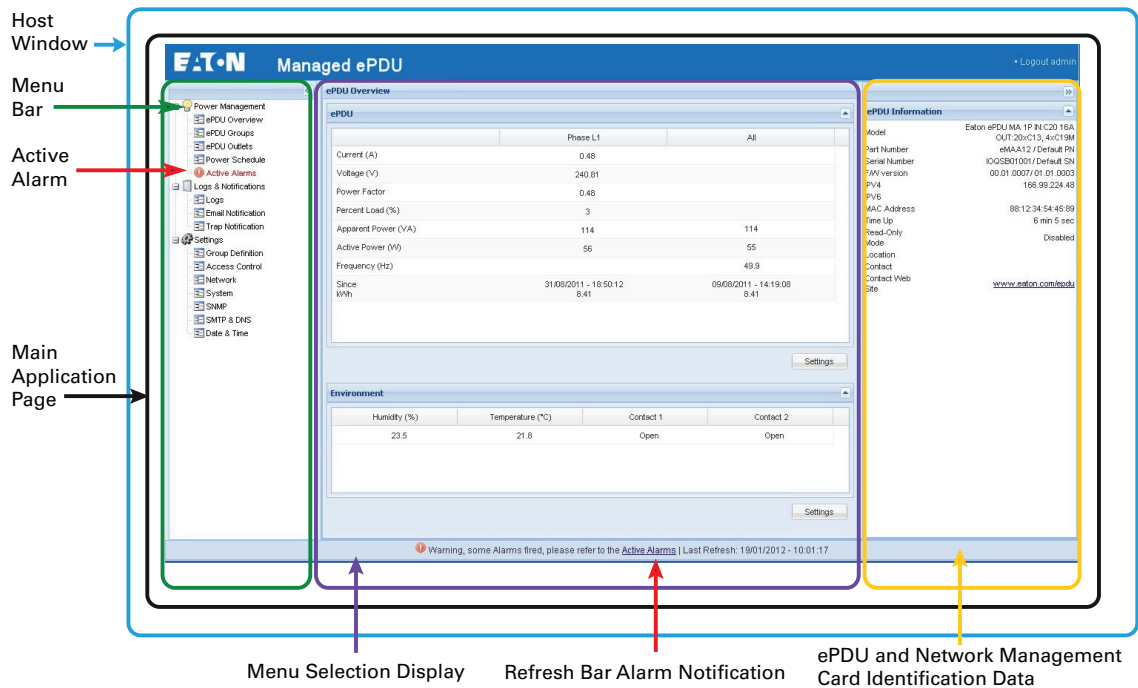

Figure 58. Navigating the Web Interface (ePDU Overview Opening Page shown)

Table 18 provides Web interface descriptions of the Web interface panels.

Table 18. Web Interface Region Descriptions









Area	Description
Host Window	The host window is the page where the application resides. The name of the application within the host window displays on the window title tab. Both the height and the width of the host window can be resized. The application panels resize at the same time. An elevator scroll button displays on the side of the application panel if the panel cannot display the entire list within the resized panel. Drag the elevator scroll button up or down to view the entire list of data in the application panel.
Menu Bar	<p>The menu bar on the left panel contains links to pages for configuring the system or managing and monitoring the ePDU. The menu hierarchy is expandable and collapsible. You can move the menu bar out of view using the horizontal scrolling tab at the bottom of the page.</p> <p>Click any selection in the menu bar to retrieve ePDU performance data, review operation log information, retrieve system identification information, or enter a configuration setting (see Figure 60). The data on the selected page is presented in table format.</p>
Main Application Page	<p>As each menu link is selected, the corresponding information displays on the Main Application page. The top of the page displays the application title.</p> <p>NOTE You can expand your view of the Main Application Page contents vertically using the elevator scroll button on the side of the page. If you need more window viewing area, resize the Host Window to a wider or taller size. This enlarges the Main Application Page.</p>
Operation Buttons and Icons	Operation buttons and icons are provided to save data entries and updates. Enter data by typing or selecting entries and clicking the associated button. Some pages have buttons for specialized functions, such as clearing accumulated data logs. File operation icons are also provided to save or download files.
ePDU Identification Panel	This panel displays identification information for the ePDU that is providing data. The data fields include a model description, part number, serial number and the current ePDU firmware version in use.
Network Management Card Identification Panel	This panel displays identification information for the resident ePDU Network Management Card card. The data fields include the part number, serial number, firmware version in use, the IP and MAC address, duration in service, location, contact information, and current read-only state.
Current Alarms (when active)	<p>These indicators alert you to the presence of currently active system alarms. The first indicator is in the menu hierarchy, where the text for Active Alarms appears as red. Opening the Active Alarms page displays the current active alarms. The second indicator appears as a notification in the bottom of the window (the refresh bar) that conveys: "Warning, some alarms fired, please refer to the Active Alarms Last Refresh: <i>dd/mm/yyyy - hh:hh:ss</i>"</p> <p>The following symbols indicate the alarm level when an alarm threshold setting is exceeded:</p> <p>Active Alarms Present</p> <p></p> <p>High Critical Threshold Alarm</p> <p></p> <p>High Warning Threshold Alarm</p> <p></p> <p>Low Warning Threshold Alarm</p> <p></p>

Table 18. Web Interface Region Descriptions (Continued)

Area	Description
	Low Critical Threshold Alarm
	
	Outlet is On
	
	Outlet is Off
	

Accessing the Web Interface

The Web interface can be accessed using a standard Web browser. Up to eight users can be provided with access to the interface, but only one administrator can be identified. Web access is enabled by default, but the administrator can disable access for any user.

NOTE  The ePDU defaults to using Dynamic Host Configuration Protocol (DHCP) when delivered. If you are unable to connect to the ePDU through the network connection with this default address, change the IP address using the Serial interface before using any of the network interfaces. See Chapter 8, “Serial Interface Operation” on page 99 for more information.

To access the Web interface:

1. Open the Web browser.
2. Enter a new IP address or select the previously entered IP address of the ePDU from the URL address drop list. The Authentication dialog displays.
3. Enter a valid user name and password in the authentication dialog box (see Figure 59). Click **Login** to continue or **Cancel** to exit.

NOTE  The default user name is “admin” and the default password is “admin.”

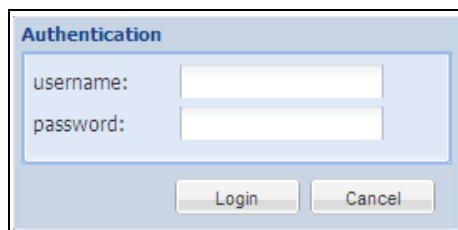

Figure 59. Login Authentication

4. The ePDU Overview page displays.
5. To access another page, click any selection in the menu bar. The page that corresponds to your menu selection opens and displays in the Main Application page.

Menu Selections

The Menu Bar provides three groups of selections (see Figure 60):

- Power Management
- Logs and Notifications
- Settings



NOTE Selecting the **Settings** button on any power management page displays a separate window that allows you to change settings, such as alarm thresholds. See for “Modify Settings” on page 56 for setting descriptions, values, and value ranges.

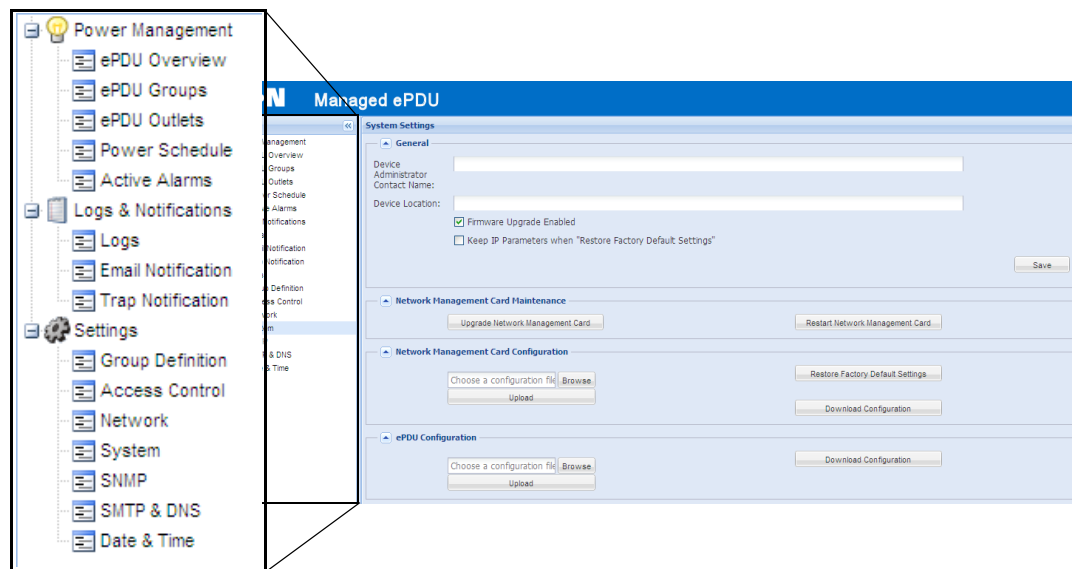

Figure 60. Menu Selections

Power Management

Use the Power Management menu selections to see current operating measurements on the ePDU Overview page. This page provides the present readings for the ePDU that is reporting data. The readings are reported per phase and, for three-phase ePDUs, all phases. The display includes data such as current, voltage, and power factor.

You can manage individual outlets on the ePDU Outlets page or groups of outlets on the ePDU Groups page. These pages provide the present measurements or readings for current, load percentage, apparent power, and active power. You can set individual outlets or groups of outlets to On, Off, or Reboot.

The Power Schedule page allows you to schedule automatic power On, power Off, or Reboot actions for selected outlets. These schedules can be set for a single instance, daily, weekly, or monthly activity at specified time intervals.

You can check current alarms on the Active Alarms page to see a list of alarms by date, time, and description. See “Alarms, Notices, and Events” on page 128 for a list of alarms.

Logs & Notifications

Use the Logs & Notifications menu selections to see a list of the most recent events (Logs page). You can also set e-mail notifications (E-mail Notification page) and trap receivers (Trap Notification page). You can test these notifications once you set or reset the parameters.

Settings

The Settings menu selections allow you to configure administrative settings, system attributes, and network access and control. This menu includes the following:

- **Group Definition:** Group definition is the process of associating a group of outlets that are logically linked on the same ePDU. By using groups of synchronized outlets, you can ensure that outlets turn on, turn off, and reboot in a synchronized manner. You can assign a defined group (or outlets) to one user.
- **Access Control:** The Access Control page allows you to set up the system administrator (Superuser) and up to eight other users with passwords and security levels of access.
- **Network:** This selection allows you to configure Ethernet, IPv4, and IPv6 settings.
- **System:** Use the System selection for identifying the administrator contact information, uploading an ePDU or Network Management Card configuration file, and upgrading, restarting, or restoring factory default configuration to the Network Management Card. You can select the “Keep IP” setting to avoid overwriting all of your configuration settings when you restore the Network Management Card to factory default settings. See Chapter 5, “Restore the Default Factory Settings of the Network Management Card” on page 56 for more information.
- **SNMP:** Use the Simple Network Management Protocol (SNMP) page to configure general SNMP settings, SNMPv1 settings, and SNMPv3 settings. You can also access the Eaton ePDU Management Information Base (MIB) from this page.
- **SMTP and DNS:** This selection is used to establish the Simple Mail Transfer Protocol (SMTP) setting for the server, login, and password. Use this selection to set up the primary and secondary Domain Name System (DNS) servers.
- **Date & Time:** The Date & Time page allows you to select the date format and set the date and time, either manually or by synchronizing with the NTP server. You can set the time zone and have the option of allowing Daylight Savings Time.

Note that not all Web interface pages refresh automatically.

ePDU Overview

Review/Modify ePDU Data

1. Access the Web interface and log in.
2. The ePDU Overview page displays.
3. In the ePDU Information panel, review basic identification information.
4. In the ePDU panel, review the present basic monitoring data.
5. To modify ePDU voltage and current threshold values, click **Settings**. The Unit Settings dialog displays.
6. To enter new threshold values, type new values in any of the text boxes that follow, then click **Save**:
 - Low voltage warning threshold
 - High voltage warning threshold
 - High critical voltage warning threshold
 - High current warning threshold
 - High critical current threshold

7. To reset the threshold values to the default values, click **Default**, then click **Save**.
8. To reset a kilowatt hour (kWh) counter to zero, click **Reset kWh**, then click **Save**.



NOTE If you do not save the action, the kWh counter remains unchanged.

Configure Environment Sensor Settings

1. Access the Web interface and log in.
2. The ePDU Overview page displays.
3. In the Environment panel, review the present ePDU environment monitoring temperature and humidity data.

NOTE The environmental monitoring data panel only displays data under these circumstances:



- if the environmental sensor is installed and configured in the system
- if the user is an administrator or a non-located user with Read/Write access rights

-
4. To modify environment threshold values, or to receive alarms when dry contacts change states, click **Settings**. The Environment Settings dialog displays.
 5. Select °C or °F in the Temperature drop-down list to change the temperature scale (Celsius or Fahrenheit unit of measurement).
 6. To enter new threshold values, type new values in any of the text boxes that follow, then click **Save**:
 - High temperature warning threshold
 - High critical temperature warning threshold
 - High humidity warning threshold
 - High critical humidity threshold
 7. To reset the threshold values to the default values, click **Default**, then click **Save**.
 8. To choose if you are notified when a dry contact state changes (Open or Closed), select one of the settings from the drop-down list under Open or Closed for the specified contact, then click **Save**:
 - **Informational**: No alarm is generated.
 - **Alarm**: An alarm is generated when the specified dry contact is Open or Closed.

ePDU Groups

NOTE 1 Some monitoring data do not display for the Switched ePDU (eSWA04) user-defined groups. This includes Current, Percent load, Apparent Power, Active Power, and kWh.



NOTE 2 You cannot change the state (On, Off, or Reboot) of a group of outlets using the Web interface for Advanced Monitored ePDUs.

Review/Modify ePDU Groups

1. Access the Web interface and log in.
2. Under Power Management, select ePDU Groups. The ePDU Groups page displays.
3. Review basic monitoring information for Factory Groups and user-defined groups.
4. To apply an operative action to all outlets in a selected group, select one of the following values from the drop-down list adjacent to the group, then click **Save**.
 - **On**: Turn on the selected group of outlets.
 - **Off**: Turn off the selected group of outlets.
 - **Reboot**: Reboot the selected group of outlets.
5. To modify ePDU threshold values for a specified group, click the **Settings** button adjacent to the group. The Group Settings dialog displays.
6. **Administrator or User with Read/Write/Control only.** To specify the duration outlets in this group will be Off before switching On during a reboot, type the number of seconds the outlets should be Off in the Power Reboot Period text box. Click **Save**.

NOTE 1 If you enter a value less than five seconds, some traps #33 (Outlet State change) may be lost.



NOTE 2 This setting overwrites the Power Reboot Period defined for individual outlets on the Outlet Settings dialog.

7. To enter new threshold values, type new values in any of the text boxes that follow, then click **Save**:
 - Low current warning threshold
 - High current warning threshold
 - High critical current threshold
8. To reset the threshold values to the default values, click **Default**, then click **Save**.
9. To reset a kilowatt hour (kWh) counter to zero, click **Reset kWh**, then click **Save**.

ePDU Outlets

NOTE 1 You can change the state of an outlet (On, Off, or Reboot) through the Web interface for Managed and Switched ePDUs only. You cannot change the state of an outlet through the Web interface for Advanced Monitored ePDUs.



Review/Modify ePDU Outlets

1. Access the Web interface and log in.
2. Under Power Management, select ePDU Outlets. The ePDU Outlets page displays.
3. Review basic monitoring information for individual outlets.
4. To apply an operative action for a selected outlet, select one of the following values from the drop-down list adjacent to the outlet, then click **Save**.
 - **On**: Turn on the outlet.
 - **Off**: Turn off the outlet.
 - **Reboot**: Reboot the outlet.

5. To modify ePDU threshold values for a specified outlet, click the **Settings** button adjacent to the outlet. The Outlet Settings dialog displays.
6. To set whether an outlet state (On, Off, or Reboot) can be changed, check or uncheck the Enable Switching check box, then click **Save**.
 - **Disabled:** Uncheck the check box to disable the setting, which indicates that the outlet state cannot be changed.
 - **Enabled:** Check the check box to enable the setting, which indicates that the outlet state can be changed.
7. To set the state of the outlet with the ePDU is powered on, select one of the following values from the State on Device Startup drop-down list, then click **Save**:
 - **On:** The outlet is powered after a duration of time set in the Outlet Switch On After field.
 - **Off:** The outlet is not powered.
 - **Last Known State:** The outlet is powered on if it was On when the ePDU was powered Off. Otherwise, the outlet is not powered.
8. **Administrator or User with Read/Write/Control only.** To specify the duration an outlet will be Off before switching On during a reboot, type the number of seconds the outlet should be Off in the Power Reboot Period(s) text box. Click **Save**.

NOTE 1 If you enter a value less than five seconds, some traps #33 (Outlet State change) may be lost.



NOTE 2 This setting can be overwritten by the Power Reboot Period defined for groups of outlets on the Group Settings dialog.

9. To enter new threshold values, type new values in any of the text boxes that follow, then click **Save**:
 - Low voltage warning threshold
 - High voltage warning threshold
 - High critical voltage threshold
 - High current warning threshold
 - High critical current threshold
10. To reset the threshold values to the default values, click **Default**, then click **Save**.
11. To reset a kilowatt hour (kWh) counter to zero, click **Reset kWh**, then click **Save**.

Power Schedule



NOTE Power schedules can be set by an Administrator with Read/Write/Control only.

Define a Power Schedule

1. Access the Web interface and log in.
2. Under Power Management, select Power Schedule. The Power Schedule page displays.
3. Select one power schedule from the list of power schedules. (The default is Power Schedule x, where x is the schedule number.)
4. Either accept the default name in the Name text box or type a new name to identify the new Power Schedule (maximum of 31 characters).

5. Choose the action state of the schedule from the drop-down list:
 - **Disabled:** The actions in this schedule are not executed, but the configuration details are saved under the name you entered so this schedule can be re-enabled or edited later (default).
 - **Enabled:** The actions in this schedule are executed.
6. If you will not assign a user to this power schedule, go to step Step 8. Otherwise, check the Attribute this Power Schedule to a User check box and continue to the next step.
7. Type the name of the user to whom you are assigning this power schedule.



NOTE If the user is collocated, only the assigned outlets can be scheduled. Note that if you assign a power schedule to a collocated user, only the outlets or outlet groups that are attached to this user will display.

8. Expand the Add Outlets panel.
9. Isolate the outlets you want to schedule by selections in the Factory Groups, Defined Groups, and Outlets lists. To assign outlets to this schedule, select a category from the left list and click the right arrow to move them into the right list. The outlets that will be controlled by this schedule are listed in the Selected Outlets list.



NOTE You can also deselect outlets by moving them back to the left list. If the user is collocated, only the assigned outlets will display.

10. Add an action in the first action block by selecting either **On**, **Off**, or **Reboot** from the drop-down list.
11. Set the schedule for this action by selecting a date and time from the drop lists for the Date of Next action field.
12. Select an interval for the action by typing the number of days in the interval in the Periodic Action(s) text box.
 For example, if you only want the action to occur once, type 0. If you want the action to occur every other day, type 1. If you want the action to occur one day each month, type 28.
13. If you want to add a second action, check the Add New Action check box because a second action is disabled by default and must be enabled.
14. Add an action in the second action block by selecting either **On**, **Off**, or **Reboot** from the drop-down list.
15. Set the schedule for this action by selecting a date and time from the drop lists for the Date of Next action field.
 This date and time must occur after the date and time set for the first action. (The action will assume the same interval as set for the first action.)
16. Click **Save**.

Active Alarms

Review Active Alarms

1. Access the Web interface and log in.
2. Under Power Management, select Active Alarms. The Active Alarms page displays.
3. Click **Refresh** to ensure that you are viewing the most current data.

4. Review the alarm detection date/time and the alarm description.

**NOTE**

The term “active alarms” indicates that the alarm is currently set. When an alarm disappears, it is removed from this page. Note that this page is not automatically refreshed.

Logs

Clear the Event Log

1. Access the Web interface and log in.
2. Under Logs & Notifications, select Logs. The Logs page displays.
3. Click **Clear**.

**NOTE**

A collated user cannot clear event logs. Only a non-collated user or an administrator can clear the log.

Download the Event Log as a Comma Separated Value File

1. Access the Web interface and log in.
2. Under Logs & Notifications, select Logs. The Logs page displays.
3. From the **Save to File** drop-down list, choose the range of data to saved as a Microsoft Excel Comma Separated Value (CSV) file:
 - **ALL**: saves all events that are shown in the window.
 - **SYSTEM**: saves only the system-related events.
 - **PDU**: saves only the ePDU-related events.
4. Click **Save to File**. The File Download dialog displays.
5. Click **Save**. The Save As window displays.
6. From the **Save in** drop-down list, specify where the file should be downloaded.
7. Either accept the default file name (logevent.csv) or enter a new file name.
8. Click **Save**.

Email Notification

Configure the Email Receivers

1. Access the Web interface and log in.
2. Under Logs & Notifications, select Email Notification. The Email Notification page displays.
3. Select the e-mail receiver to configure from the combo box.
4. Type the e-mail receiver address, such as e-mail1@Recipient.com.
5. Type the descriptive text to identify the e-mail receiver.
6. Enable the e-mail receiver from the combo box.

**NOTE**

If the e-mail receiver is a collocated user, the user can only change the e-mail configuration if they have at least Read/Write privileges.

7. Check the Attached Files check box to attach the event log file to the e-mail sent to this receiver, or uncheck the box to send the e-mail without the event log file.
8. What type of alarm notification do you want to provide to the e-mail receiver?
 - To always send a notification when an alarm is generated or is resolved, choose **All Alarms** from the **On Event** combo box.
 - To send periodic e-mails, perform the following:
 - Set the date of the next report by entering a day of the month. For example, entering 4 means the 4th day of the current month if the current system date is before this date. If the current system date is higher than 4, this means the 4th day of the next month.
 - Type the frequency of report in days. For example, 7 means every 7 days.
 - Choose the hour to send the report from the combo box. The format is *hh:00*, where *hh* = hour. The 24-hour range is 00:00–23:00.
9. Click **Save**. If desired, click **Test** to test the configuration.

Trap Notification

Define the Trap Receivers

1. Access the Web interface and log in.
2. Under Logs & Notifications, select Trap Notification. The Trap Notification page displays.
3. Select the trap receiver to configure from the combo box.
4. Type the name to identify the trap receiver. This value is not used to send traps.
5. Choose one of the following protocols:
 - **Disabled**: the trap receiver is disabled. (No trap is sent to this user.)
 - **SNMPv1**: traps are sent over SNMPv1 protocol. (It must be compliant with the SNMP version defined in “Enable/Disable the SNMP Agent” on page 96.)
 - **SNMPv3**: traps are sent over SNMPv3 protocol. (It must be compliant with the SNMP version defined in “Enable/Disable the SNMP Agent” on page 96.)
6. Select one of the following trap sources (“On event”):
 - **None**: the trap receiver is disabled.
 - **All Alarms**: the trap receiver is enabled.
7. Type the trap receiver IPv4/IPv6 address or its host name.
8. Type the trap community.
9. Click **Save**. If desired, test the configuration (see “Test Trap”).
10. Click **Test**.

Test Trap**NOTE**

To receive the test trap #53, the trap receiver must be configured with a protocol compliant with the one defined as the trap source (see “Enable/Disable the SNMP Agent” on page 96).

This action consists of sending a test trap (#53) to all configured and enabled trap receivers. To achieve this action, the following requirements must be met:

- The Network Management Card is running in Normal Operation mode.
- The Network Management Card is connected to the LAN.
- The Network Management Card owns a valid IP address.
- The SNMP must be enabled: SNMPv1, SNMPv3, or SNMPv1 v3.

The target trap receiver configuration requires a valid IP address and the trap receiver protocol must match the configured SNMP version.

**NOTE**

See “Enable/Disable the SNMP Agent” on page 96.

1. Access the Web interface and log in.
2. Under Logs & Notifications, select Trap Notification. The Trap Notification page displays.

Group Definition**Configure an Outlet Group**

1. Access the Web interface and log in.
2. Under Settings, select Group Definition. The Group Definition page displays.
3. Select one group from the list of groups. (The default is Group x, where x is the outlet number.)
4. Either accept the default name in the Name text box or type a new name to identify the new group.
5. Select **Enable** from the drop-down list. (Groups with disabled status are not visible in the ePDU Group menu.)
6. To assign outlets to this group, select the name of the outlets from the Factory Groups, Defined Groups, or Outlets panel and click the right arrow. The outlets move to the Selected Outlets panel.
7. Click **Save**.
8. To ensure that you have configured the outlet groups correctly, select ePDU Group from menu bar in the to view the groups list.

**NOTE**

Up to 12 groups can be configured. You cannot create an empty group.

Access Control

**NOTE**

There can only be one Superuser with Read/Write/Control access rights and up to eight multi-users with configurable access rights.

Configure the Superuser

1. Access the Web interface and log in.
2. Under Settings, select Access Control. The Access Control page displays.
3. In the General Access panel, perform the following:
 - Type the Superuser login.
 - Type the Superuser password.
 - Type the Superuser password again.
4. Click **Save**.

Configure Multi-Users

1. Access the Web interface and log in.
 2. Under Settings, select Access Control. The Access Control page displays.
 3. In the Multi-User Access panel, perform the following:
 - Select the user to configure from the combo box.
 - Type the user's login.
 - Type the user's password (minimum of five characters).
 - Type the user's password again.
 4. Choose one of the following security levels:
 - **No Access:** The user is not allowed to access the Web interface.
 - **Read-Only:** The user can access the Web interface, view the measures, and view the thresholds of the outlets and groups. This user is not allowed to change any settings or perform actions.
 - **Read/Write:** The user can access the Web interface, view the measures, and is allowed to change settings. This user is not allowed to perform actions, such as switching outlets Off and On.
 - **Read/Write/Control:** The user can access the Web interface and is allowed to change settings and perform actions, such as switching outlets Off and On.
 5. Assign attribute groups to this user.
 6. Locate the name of the groups you will assign to this user.
 7. Select the name of the groups from the Available Groups panel and click the right arrow. The groups move to the Selected Groups panel.
-

**NOTE**

If groups are not assigned, the user will be considered to be non-collocated.

8. Click **Save**.

Enable/Disable SSL Encryption

By default, Secure Sockets Layer (SSL) encryption is disabled.

1. Access the Web interface and log in.
2. Under Settings, select Access Control. The Access Control page displays.
3. Ensure that the **HTTP Enabled** check box is checked.
4. Check the **Force SSL** check box to enable SSL encryption, or uncheck the box to disable it.
5. Open the System page.
6. Restart the Network Management Card. See “Restart the Network Management Card” on page 56.



NOTE With SSL encryption, the Web interface is accessible from **https://<IPv4 address>** and/or **https://[IPv6 address]** according to the IP configuration.

Enable/Disable the Telnet Interface



NOTE By default, the Telnet interface is disabled. This action requires Administrator privileges.

1. Access the Web interface and log in.
2. Under Settings, select Access Control. The Access Control page displays.
3. Check the **Telnet Enabled** check box to enable the Telnet interface, or uncheck the box to disable it.
4. Open the System page.
5. Restart the Network Management Card. See “Restart the Network Management Card” on page 56.

Network

Configure the Ethernet Link Speed and Duplex Mode

NOTE By default, the Ethernet link speed and duplex mode is configured on “auto-negotiation” which means the Network Management Card adapts its Ethernet speed and duplex mode to the network on which it is connected. However, it is possible to force the following modes:



- Auto-negotiation
- 100 Mbps Full Duplex
- 100 Mbps Half Duplex
- 10 Mbps Full Duplex
- 10 Mbps Half Duplex

1. Access the Web interface and log in.
2. Under Settings, select Network. The Network page displays.

3. In the Ethernet panel, choose one of the following link speed and duplex modes from the combo box:
 - Auto-negotiation
 - 100 Mbps Full Duplex
 - 100 Mbps Half Duplex
 - 10 Mbps Full Duplex
 - 10 Mbps Half Duplex
4. Click **Save**.
5. Open the System page.
6. Restart the Network Management Card (Network Management Card). See “Restart the Network Management Card” on page 56.

Configure the IPv4 Settings

1. Access the Web interface and log in.
2. Under Settings, select Network. The Network page displays.
3. In the IPv4 panel, select the manner by which IPv4 settings are configured from the DHCP combo box:
 - **Enabled.** The IPv4 settings are configured by the DHCP server. If DHCP is enabled, go to Step 5.
 - **Disabled.** The IPv4 settings are manually configured by the user. If DHCP is disabled, perform the following:
 - Type the IPv4 address.
 - Type the IPv4 subnet mask.
 - Type the IPv4 address of the gateway (if any).
 - Type the ePDU host name (used for DNS resolution).
4. Click **Save**.
5. Open the System page.
6. Restart the Network Management Card. See “Restart the Network Management Card” on page 56.

Configure the IPv6 Settings



NOTE

By default, the IPv6 interface is disabled. You can enable it from the Web interface or the Serial interface.

1. Access the Web interface and log in.
2. Under Settings, select Network. The Network page displays.
3. In the IPv6 panel, enable the IPv6 interface by checking the IPv6 Enabled check box.

4. Select one of the following configuration methods for IPv6 settings:



NOTE Regardless of the configuration you choose, the local IPv6 address is auto-generated by the Network Management Card.

- For manual configuration, uncheck the **IPv6 Address Auto Configuration Enabled** check box. Continue to Step 5.
- For auto configuration, check the **IPv6 Address Auto Configuration Enabled** check box. Continue to Step 10.

NOTE 1 For manual configuration, provide the IPv6 global address with its prefix length and the IPv6 address of the gateway (if any).



NOTE 2 For auto-configuration, the global IPv6 addresses and prefix lengths are automatically configured by the network (an IPv6 router is required). The gateway IPv6 address is defined by the user.

5. Type the local IPv6 address.
6. Type the global IPv6 address.
7. Type the prefix length for the global IPv6 address.
8. Type the IPv6 gateway address (if any).
9. Click **Save**.
10. Open the System page.
11. Restart the Network Management Card. See “Restart the Network Management Card” on page 56.

System

Enable/Disable Firmware Upgrade

1. Access the Web interface and log in.
2. Under Settings, select System. The System page displays.
3. Type the Device Administrator Contact Name and the Device location in the text boxes.
4. Choose whether the firmware upgrade functionality can be used:
 - **Enabled:** Check the check box to use the firmware upgrade functionality (default).
 - **Disabled:** Uncheck the check box to disable the firmware upgrade functionality.
5. Choose whether the IP setting should remain unchanged after a default factory reset of the Network Management Card.
 - **Enabled:** Check the check box to retain IP settings at their current values
 - **Disabled:** Uncheck the check box to reset IP settings to default values (default).
6. Click **Save**.

Network Management Card Maintenance

1. Access the Web interface and log in.
2. Under Settings, select System. The System page displays.
3. Type the Device Administrator Contact Name and the Device location in the text boxes.
4. To initiate an upgrade, check the Network Management Card Upgrade check box.



IMPORTANT

See “Network Management Card Firmware Upgrade” on page 120 for detailed information before initiating an upgrade.

5. To initiate a restart, check the Restart Network Management Card check box.



IMPORTANT

See “Restart the Network Management Card” on page 127 for detailed information before initiating a restart.



NOTE

The Network Management Card saves all current settings in the Network Management Card file system before restarting. Restarting the Network Management Card does not restart the ePDU or change the power status of the outlets. See “Restarting the Network Management Card” on page 42.

Network Management Card Configuration

1. Access the Web interface and log in.
2. Under Settings, select System. The System page displays.
3. Type the Device Administrator Contact Name and the Device location in the text boxes.
4. To select and transfer a Network Management Card configuration file:
 - Use **Browse** to review and select the configuration file.
 - Click either **Upload** or **Download Configuration**.



IMPORTANT

See “Download/Upload the Network Management Card File Configuration” on page 53 for detailed information before initiating a restart.

5. To restore the Network Management Card Factory Default settings, check the check box.



NOTE

See “Restore the Default Factory Settings of the Network Management Card” on page 56 for more information.

ePDU Configuration

1. Access the Web interface and log in.
2. Under Settings, select System. The System page displays.
3. Type the Device Administrator Contact Name and the Device location in the text boxes.

4. To select and transfer an ePDU configuration file:
 - Use the Browse button to review and select the configuration file.
 - Click either **Upload** or **Download Configuration**.



IMPORTANT

See “Download/Upload the ePDU File Configuration” on page 53 for detailed information before initiating a restart.

SNMP

Enable/Disable the SNMP Agent

1. Access the Web interface and log in.
2. Under Settings, select SNMP. The SNMP page displays.
3. Choose one of the following SNMP versions:
 - **Disabled:** the agent is disabled; the MIB cannot be read and no traps are sent.
 - **SNMPv1:** only SNMPv1 users and SNMPv1 traps are supported.
 - **SNMPv3:** only SNMPv3 users and SNMPv3 traps are supported.
 - **SNMPv1 & v3:** both SNMPv1 and SNMPv3 users and traps are supported.
4. Click **Save**.

Define SNMPv1 Users

1. Access the Web interface and log in.
2. Under Settings, select SNMP. The SNMP page displays.
3. In the SNMPv1 field, select the SNMPv1 user to configure from the combo box.
4. Type the SNMPv1 community name (user name) you intend to use to access the MIB objects.
5. Choose one of the following access rights for the SNMPv1 user:
 - **No access:** the SNMPv1 user is disabled with no access to the MIB objects.
 - **Read-Only:** the SNMPv1 user can only get the MIB objects.
 - **Read/Write:** the SNMPv1 user can get and set the MIB objects.
6. Click **Save**.

Define SNMPv3 User-based Security Model Users

1. Access the Web interface and log in.
2. Under Settings, select SNMP. The SNMP page displays.
3. In the SNMPv3 field, select the SNMPv3 user to configure from the combo box.
4. Type the SNMPv3 user name.
5. Choose one of the following access rights for the SNMPv3 user:
 - **No Access:** the SNMPv3 user is disabled with no access to the MIB objects.
 - **Read-Only:** the SNMPv3 user can only get the MIB objects.
 - **Read/Write:** the SNMPv3 user can get and set the MIB objects.

6. Choose one of the following security levels to be applied to the SNMPv3 user:
 - **Not Set**: The SNMPv3 user is not configured and therefore disabled.
 - **No Auth No Priv**: No authentication password or privacy key are required to access the MIB objects.
 - **Auth No Priv**: An authentication password but no privacy key are required to access the MIB objects.
 - **Auth Priv**: An authentication password and a privacy key are required to access the MIB objects.
7. Type the authentication password (if required by security level), with 8 to 24 characters allowed.
8. Type the privacy key (if required by security level), with 8 to 24 characters allowed.
9. Click **Save**.

SNMP & DNS

Configure the DNS

When the IPv4 address is automatically obtained by DHCP, the DNS server addresses (primary and secondary) are provided by the DHCP server.

Nevertheless, you can define DNS IPv4/IPv6 addresses from the Web and Serial interfaces. However, this configuration is overwritten when the Network Management Card restarts and the IPv4 address is obtained from a DHCP server that provides DNS addresses.

1. Access the Web interface and log in.
2. Under Settings, select SMTP & DNS. The SMTP & DNS page displays.
3. Type the primary DNS server's IPv4 or IPv6 address.
4. Type the secondary DNS server's IPv4 or IPv6 address (if any).
5. Click **Save**.

Configure the SMTP

1. Access the Web interface and log in.
2. Under Settings, select SMTP & DNS. The SMTP & DNS page displays.
3. Type the SMTP server IPv4/IPv6 address or host name.
4. If your SMTP server requires authentication, perform the following:
 - Check the SMTP Server Authentication check box.
 - Type the login.
 - Type the password.
 - Type the sender address.
5. Click **Save**.

Date & Time

Manually Configure the Date and Time

1. Access the Web interface and log in.
2. Under Settings, select Date & Time. The Date & Time page displays.
3. Choose the date format from the combo box.
4. Click **Save**.

5. Click the **Set manually** radio button.
6. Type the date according to the format defined by Date Format.
7. Type the time. The time format is *hh:mm:ss*, where *hh* = hours, *mm* = minutes, *ss* = second.
8. Click **Save**.

Automatically Configure the Date and Time

1. Access the Web interface and log in.
2. Under Settings, select Date & Time. The Date & Time page displays.
3. Choose the date format from the combo box.
4. Click **Save**.
5. Click the **Synchronize with NTP Server** radio button
6. Type the Time Server IPv4/IPv6 address or host name.
7. Choose the time zone from the combo box.
8. Configure the Daylight Saving Time option.
9. Click **Save**.

**NOTE**

The Network Management Card retrieves the date and time from the configured NTP server every hour.

Chapter 8 Serial Interface Operation

This section describes remotely configuring and monitoring an Eaton Advanced Enclosure Power Distribution Unit (ePDU) through the serial connection between the ePDU internal Network Management Card and a laptop or workstation.

Access to a Serial interface command line interface (CLI) is provided through a terminal emulation program, such as HyperTerminal or PuTTY, or through Telnet.



NOTE

A terminal emulation program can communicate with another computer or network as if it were a specific type of terminal directly connected to that computer or network.

Once connected, you can perform basic configuration and monitoring tasks for the ePDU to which you are connected, including the following:

- Retrieve selected meters and measurements, including current, present power, temperature, and input voltage
- Set or retrieve ePDU critical alarm high threshold values
- Set or retrieve high temperature warning or alarm threshold values, and low humidity warning or alarm threshold values
- Set or retrieve settings for dry contact sensors connected to the ePDU
- Retrieve selected ePDU equipment, software version, and ratings information
- Reset the ePDU settings to factory defaults or reboot the ePDU



NOTE

The ePDU defaults to using Dynamic Host Configuration Protocol (DHCP) when delivered. If you are unable to connect to the ePDU through the network connection with this default address, change the IP address using the serial interface before using any of the network interfaces.

Navigating the Serial Interface

The ePDU serial interface is used to remotely configure the ePDU.

Connecting the Equipment

1. Connect the serial cable to the ePDU service port and the PC COM port.
2. Use a terminal emulator with these settings:
 - Bits per second: 9600
 - Data bits: 8
 - Stop bits: 1
 - Parity: None
 - Flow Control: None



NOTE

Disable the “Echo typed characters locally” option.

Accessing the Interface

1. Press [Enter] to display the login menu (see Figure 61).

```

Ready
+-----+
|                                     |
|                                     |
|                                     |
|                                     |
+-----+
Enter Password:

```

Figure 61. Login Menu

2. Type the Superuser password and press [Enter]. The Main Menu displays (Figure 62).

```

+-----+
|                                     |
|                                     |
|                                     |
|                                     |
+-----+
1. Network Management Card Settings
2. Factory Reset (Network Management Card only)
3. Restart Network Management Card
4. Firmware Upgrade Mode
5. Clear ePDU & System Log
0. Exit
Please enter your choice => _

```

Figure 62. Main Menu**Selecting a Configuration Menu**

1. From the Main Configuration Menu, type the number for the desired selection and press [Enter]. The selected menu displays (see Figure 63 for an example menu).

```

+-----+
|                                     |
|                                     |
|                                     |
|                                     |
+-----+
1. Network Management Card Information
2. Network Settings
3. Trap Receivers
4. SNMPv1 Community
5. SNMPv3 USM Table
6. Date and Time
7. Email Notifications
8. Super User Name and Password
9. Multi-Users
10. EnergyWise Setting
0. Back to main menu
Please enter your choice => _

```

Figure 63. Network Management Card Menu

Network Management Card Information

1. Access the Serial interface and log in.
2. Type **1** (Network Management Card Settings) and press [Enter].
3. Type **2** (Network Settings) and press [Enter].
4. Type **1** (Network Management Card Information) and press [Enter]. The Network Management Card Information Menu displays. Review the following read-only information fields:
 - Network Management Card's Bootloader Revision
 - Network Management Card's Firmware Revision
 - Network Management Card's Hardware Revision
 - Network Management Card's Part Number
 - Network Management Card's Serial Number
 - Network Management Card's Technical Level
 - EnergyWise API version number
5. Type **1** (System Location) to enter user-defined device location (maximum of 31 characters) and press [Enter].
6. Type **2** (System Contact) to enter the name of the user-defined system contact (maximum of 31 characters) and press [Enter].
7. Type **3** (System Unit Name) to enter the user-defined ePDU Friendly Name that identifies the ePDU in the LAN and press [Enter].
8. Type **4** (System Unit Name) and press [Enter].
9. Type **0** (Return to previous menu) and press [Enter].
10. Type **3** (Restart Network Management Card) and press [Enter].
11. Type **Y** and press [Enter]. The Network Management Card restarts.

Network Settings

IPv4 Configuration

1. Access the Serial interface and log in.
2. Type **1** (Network Management Card Settings) and press [Enter].
3. Type **2** (Network Settings) and press [Enter].
4. Type **3** (Communication Control) and press [Enter].
5. Type **2** (DHCP Control) and press [Enter].
6. Select the manner by which IPv4 settings are configured:
 - **Disabled** means that the IPv4 settings are manually configured by the user. Type **0** and press [Enter] to disable the DHCP.
 - **Enabled** means that the IPv4 settings are configured by the DHCP server. Type **1** and press [Enter] to enable the DHCP.
7. Type **0** and press [Enter]. (Return to previous menu)

8. Are the IPv4 settings enabled or disabled?
 - If DHCP is enabled, go to Step 10.
 - If DHCP is not enabled, perform the following (see Figure 64):
 - Type **1** (IPv4 Configuration) and press [Enter].
 - Type **1** (IPv4 Address) and press [Enter].
 - Type the IPv4 address and press [Enter].
 - Type **2** (Gateway Address) and press [Enter].
 - Type the IPv4 address of the gateway (if any) and press [Enter].
 - Type **3** (Network Mask) and press [Enter].
 - Type the subnet mask and press [Enter].
 - Type **0** (Return to previous menu) and press [Enter].
9. Type **0** (Return to previous menu) and press [Enter].
10. Type **0** (Return to previous menu) and press [Enter].
11. Type **3** (Restart Network Management Card) and press [Enter].
12. Type **Y** and press [Enter]. The Network Management Card restarts.

```

+-----+
|               | IPv4 Configuration Menu |
+-----+
1. IPv4 Address   : xxx.xx.xxx.132
2. Gateway Address : 166.99.224.1
3. Network Mask   : 255.255.255.0
0. Return to previous menu

WARNING: Restart the Network Management Card to apply a new configuration
Please enter your choice =>

```

Figure 64. IPv4 Configuration

IPv6 Configuration

By default, the SSL encryption is disabled.

1. Access the Serial interface and log in.
2. Type **1** (Network Management Card Settings) and press [Enter].
3. Type **2** (Network Settings) and press [Enter].
4. Type **2** (IPv6 Configuration) and press [Enter].
5. Type **1** (IPv6 Control) and press [Enter].
6. Type **1** (Enabled) and press [Enter].
7. Type **2** (IPv6 Auto-Configuration) and press [Enter].

8. Select one of the following configuration methods for IPv6 settings:



NOTE Regardless of the configuration you choose, the local IPv6 address is auto-generated by the Network Management Card.

- For manual configuration, type **0** (Disabled) and press [Enter]. Continue to Step 9.
- For auto configuration, type **1** (Enabled) and press [Enter]. Continue to Step 15.



NOTE 1 For manual configuration, provide the IPv6 global address with its prefix length and the IPv6 address of the gateway (if any).

NOTE 2 For auto-configuration, the global IPv6 addresses and prefix lengths are automatically configured by the network (an IPv6 router is required). The gateway IPv6 address is defined by the user.

9. Type **3** (IPv6 Global Address 1) and press [Enter].
10. Type the IPv6 global address and press [Enter].
11. Type **4** (IPv6 Global Prefix 1) and press [Enter].
12. Type the IPv6 global prefix **1** and press [Enter].
13. Type **5** (IPv6 Default Router) and press [Enter].
14. Type the gateway IPv6 address and press [Enter].
15. Type **0** (Return to previous menu) and press [Enter].
16. Type **0** (Return to previous menu) and press [Enter].
17. Type **0** (Return to previous menu) and press [Enter].
18. Type **3** (Restart Network Management Card) and press [Enter].
19. Type **Y** and press [Enter]. The Network Management Card restarts.

Communication Control

Ethernet Control

By default, the Ethernet link speed and duplex mode is configured on “auto-negotiation” which means the Network Management Card adapts its Ethernet speed and duplex mode to the network on which it is connected. However, it is possible to force the following modes:

- Auto-negotiation
- 100 Mbps Full Duplex
- 100 Mbps Half Duplex
- 10 Mbps Full Duplex
- 10 Mbps Half Duplex

1. Access the Serial interface and log in.
2. Type **1** (Network Management Card Settings) and press [Enter].
3. Type **2** (Network Settings) and press [Enter].
4. Type **3** (Communication Control) and press [Enter].

5. Type **1** (Ethernet Control) and press [Enter]:
 - Type **0** (Auto negotiation to enable the auto-negotiation) and press [Enter].
 - Type **1** (100 Mbps Full Duplex for a 100 Mbps, Full duplex network) and press [Enter].
 - Type **2** (100 Mbps Half Duplex for a 100 Mbps, Half duplex network) and press [Enter].
 - Type **3** (10 Mbps Full Duplex for a 10 Mbps, Full duplex network) and press [Enter].
 - Type **4** (10 Mbps Half Duplex for a 10 Mbps, Half duplex network) and press [Enter].
6. Type **0** (Return to previous menu) and press [Enter].
7. Type **0** (Return to previous menu) and press [Enter].
8. Type **0** (Return to previous menu) and press [Enter].
9. Type **3** (Restart Network Management Card) and press [Enter].
10. Type **Y** and press [Enter]. The Network Management Card restarts.

DHCP Control

1. Access the Serial interface and log in.
2. Type **1** (Network Management Card Settings) and press [Enter].
3. Type **2** (Network Settings) and press [Enter].
4. Type **3** (Communication Control) and press [Enter].
5. Type **2** (DHCP Control) and press [Enter].
 - Type **Enabled** to indicate that the IPv4 address is dynamically assigned by a DHCP server on the LAN.
 - Type **Disabled** to indicate that the Network Management card used the static IPv4 address.
6. Type **0** (Return to previous menu) and press [Enter].
7. Type **0** (Return to previous menu) and press [Enter].
8. Type **3** (Restart Network Management Card) and press [Enter].
9. Type **Y** and press [Enter]. The Network Management Card restarts.

FTP Upgrade Control

1. Access the Serial interface and log in.
2. Type **1** (Network Management Card Settings) and press [Enter].
3. Type **2** (Network Settings) and press [Enter].
4. Type **3** (Communication Control) and press [Enter].
5. Type **3** (FTP Upgrade Control), type **Enabled** or **Disabled** to indicate if the FTP upgrade functionality is activated or not activated, and press [Enter].
6. Type **0** (Return to previous menu) and press [Enter].
7. Type **0** (Return to previous menu) and press [Enter].
8. Type **3** (Restart Network Management Card) and press [Enter].
9. Type **Y** and press [Enter]. The Network Management Card restarts.

Telnet Control

By default, the Telnet interface is disabled.

1. Access the Serial interface and log in.
2. Type **1** (Network Management Card Settings) and press [Enter].
3. Type **2** (Network Settings) and press [Enter].
4. Type **3** (Communication Control) and press [Enter].
5. Type **4** (Telnet Control) and press [Enter].
6. Type **1** (Telnet Control) and press [Enter].
7. Do you want to disable or enable the Telnet interface?
 - To disable the Telnet interface, type **0** (Disabled) and press [Enter].
 - To enable the Telnet interface, type **1** (Enabled) and press [Enter].
8. Type **0** (Return to previous menu) and press [Enter].
9. Type **0** (Return to previous menu) and press [Enter].
10. Type **0** (Return to previous menu) and press [Enter].
11. Type **0** (Return to previous menu) and press [Enter].
12. Type **3** (Restart Network Management Card) and press [Enter].
13. Type **Y** and press [Enter]. The Network Management Card restarts.

```

+-----+
|                               EATON ePDU Configuration Utility                               |
+-----+
Telnet Port: 23

1. Telnet Control : Disabled
0. Return to previous menu

WARNING: Restart the Network Management Card to apply a new configuration
Please enter your choice => _
  
```

Figure 65. Telnet Control

HTTP Control

1. Access the Serial interface and log in.
2. Type **1** (Network Management Card Settings) and press [Enter].
3. Type **2** (Network Settings) and press [Enter].
4. Type **3** (Communication Control) and press [Enter].
5. Type **5** (HTTP Control) and press [Enter].
6. Type **1** (HTTP Control) and press [Enter].
7. Do you want to enable or disable the Web interface?
 - To disable the Web interface, type **0** (Disabled) and press [Enter].
 - To enable the Web interface, type **1** (Enabled) and press [Enter].

8. Type **0** (Return to previous menu) and press [Enter].
9. Type **0** (Return to previous menu) and press [Enter].
10. Type **0** (Return to previous menu) and press [Enter].
11. Type **0** (Return to previous menu) and press [Enter].
12. Type **3** (Restart Network Management Card) and press [Enter].
13. Type **Y** and press [Enter]. The Network Management Card restarts.

```

+-----+
|                                     |
|                                     |
+-----+
| HTTP Port: 80                       |
|                                     |
| 1. HTTP Control      : Enabled      |
| 0. Return to previous menu          |
|                                     |
| WARNING: Restart the Network Management Card to apply a new configuration |
|                                     |
| Please enter your choice =>         |
|                                     |
+-----+

```

Figure 66. HTTP Control

SSL Control

By default, the SSL encryption is disabled.

1. Access the Serial interface and log in.
2. Type **1** (Network Management Card Settings) and press [Enter].
3. Type **2** (Network Settings) and press [Enter].
4. Type **3** (Communication Control) and press [Enter].
5. Type **6** (SSL Control) and press [Enter].
6. Type **1** (SSL Control) and press [Enter].
7. Do you want to enable or disable SSL encryption?
 - To disable the SSL encryption, type **0** (Disabled) and press [Enter].
 - To enable the SSL encryption, type **1** (Enabled) and press [Enter].
8. Type **5** (HTTP Control) and press [Enter].
9. Type **1** (HTTP Control) and press [Enter].
10. Do you want to enable or disable the Web interface?
 - To disable the Web interface, type **0** (Disabled) and press [Enter].
 - To enable the Web interface, type **1** (Enabled) and press [Enter].
11. Type **0** (Return to previous menu) and press [Enter].
12. Type **0** (Return to previous menu) and press [Enter].
13. Type **0** (Return to previous menu) and press [Enter].
14. Type **0** (Return to previous menu) and press [Enter].
15. Type **3** (Restart Network Management Card) and press [Enter].

- Type **Y** and press [Enter]. The Network Management Card restarts.

```

+-----+
|                                     |
|                                     |
+-----+
SSL Port: 443

  1. SSL Control      : Disabled
  0. Return to previous menu

WARNING: Restart the Network Management Card to apply a new configuration

Please enter your choice => _

```

Figure 67. SSL Control

SNMP Control

- Access the Serial interface and log in.
- Type **1** (Network Management Card Settings) and press [Enter].
- Type **2** (Network Settings) and press [Enter].
- Type **3** (Communication Control) and press [Enter].
- Type **7** (SNMP Control) and press [Enter].
- Type **1** (SNMP Version) and press [Enter].
- Choose an SNMP version:
 - Disabled:** Type **0** and press [Enter]. The agent is disabled. The MIB cannot be read and no traps are sent (see Figure 68).
 - SNMPv1:** Only SNMPv1 users and SNMPv1 traps are supported. Type **1** and press [Enter].
 - SNMPv3:** Only SNMPv3 users and SNMPv3 traps are supported. Type **2** and press [Enter].
 - SNMPv1 & v3:** Both SNMPv1 and SNMPv3 users and traps are supported. Type **3** and press [Enter].

```

+-----+
|                                     |
|                                     |
+-----+
SNMP Port: 161

  1. SNMP Version    : Disabled
  0. Return to previous menu

Please enter your choice =>

```

Figure 68. SNMP Version Status

Hostname

- Access the Serial interface and log in.
- Type **1** (Network Management Card Settings) and press [Enter].
- Type **2** (Network Settings) and press [Enter].
- Type **4** (Hostname) and press [Enter].

- Type the Network Management Card host name (maximum of 31 characters) and press [Enter].



NOTE 1 This setting is sent in the DHCP request when the DHCP is enabled. If the DHCP server is coupled with a DNS server, the user can access the ePDU's web interface using this hostname instead of the IP address.

NOTE 2 Default is ePDUxy, where xy is the last two digits of the MAC address.

- Type **0** (Return to previous menu) and press [Enter].
- Type **0** (Return to previous menu) and press [Enter].
- Type **3** (Restart Network Management Card) and press [Enter].
- Type **Y** and press [Enter]. The Network Management Card restarts.

Primary and Secondary DNS IP Address



NOTE When the IPv4 address is automatically obtained by DHCP, the DNS server addresses (primary and secondary) are provided by the DHCP server. Nevertheless, you can define DNS IPv4 and IPv6 addresses from both the Web and serial interfaces. However, be aware that this configuration is overwritten when the Network Management Card restarts and the IPv4 address is obtained from a DHCP server that provides DNS addresses.

- Access the Serial interface and log in.
- Type **1** (Network Management Card Settings) and press [Enter].
- Type **2** (Network Settings) and press [Enter].
- Type **5** (Primary DNS IP Address) and press [Enter].
- Type the IPv4 or IPv6 address of the DNS server and press [Enter].
- Type **6** (Secondary DNS IP Address) and press [Enter].
- Type the IPv4 or IPv6 address of the DNS server and press [Enter].

```

=====
|                                     EATON ePDU Configuration Utility                                     |
=====
Ethernet Address      : 00:20:85:F9:00:BE

 1. IPv4 Configuration
 2. IPv6 Configuration
 3. Communication Control
 4. Hostname           : epduBE
 5. Primary DNS IP Address : 151.110.239.25
 6. Secondary DNS IP Address : 151.110.239.27
 0. Return to previous menu

WARNING: Restart the Network Management Card to apply a new configuration
Please enter your choice =>

```

Figure 69. Primary DNS IP Address

Trap Receivers

1. Access the Serial interface and log in.
2. Type **1** (Network Management Card Settings) and press [Enter].
3. Type **3** (Trap Receivers) and press [Enter].
4. Type **2** (Modify - Modify a table entry) and press [Enter].
5. Type the number of trap receiver to modify and press [Enter].
6. Type the trap receiver IPv4/IPv6 address or its host name and press [Enter].
7. Type the trap community and press [Enter].
8. Choose a trap type:
 - **Disabled:** The trap receiver is disabled. No trap is sent to this user. Type **0** and press [Enter].
 - **Enabled:** The trap receiver is enabled. Type **1** and press [Enter].
9. Choose one of the following the protocols:
 - **Disabled:** The trap receiver is disabled. No trap is sent to this user. Type **0** and press [Enter].
 - **SNMPv1:** Traps are sent over SNMPv1 protocol. (It must be compliant with the SNMP version defined in "SNMP Control" on page 107.) Type **0** and press [Enter].
 - **SNMPv3:** Traps are sent over SNMPv3 protocol. (It must be compliant with the SNMP version defined in "SNMP Control" on page 107.) Type **0** and press [Enter].
10. Type the name to identify the trap receiver and press [Enter]. This value is not used to send traps.



NOTE

To receive the test trap #53, the trap receiver must be configured with a protocol compliant with the one defined in "SNMP Control" on page 107.

SNMP v1 Community

1. Access the Serial interface and log in.
2. Type **1** (Network Management Card Settings) and press [Enter].
3. Type **4** (SNMPv1 Community) and press [Enter].
4. Type **1** (Modify - Modify a table entry) and press [Enter].
5. Type the number of SNMPv1 user to modify and press [Enter].
6. Type the community name (SNMP user's name) and press [Enter].
7. Choose the access rights allowed to the SNMPv1 user as follows:
 - **No Access:** The SNMPv1 user is disabled with no access to the MIB objects. Type **0** and press [Enter].
 - **Read-Only:** The SNMPv1 user can only get the MIB objects. Type **1** and press [Enter].
 - **Read/Write:** The SNMPv1 user can get and set the MIB objects. Type **2** and press [Enter].



NOTE Command selection 2 allows you to reset a table entry to the default values. Type the number of the user to reset and press [Enter].

```

+-----+
| Community Name                Access                |
+-----+-----+
[1] public                       No Access
[2] private                       No Access

COMMANDS -
1. Modify - Modify a table entry
2. Reset - Reset a table entry to default
0. Return to previous menu

Please enter your choice => _

```

Figure 70. SNMPv1 Community Menu

SNMP V3 USM Table

Modify a Table Entry

1. Access the Serial interface and log in.
2. Type **1** (Network Management Card Settings) and press [Enter].
3. Type **5** (SNMPv3 USM Table) and press [Enter].
4. Type **1** (Modify - Modify a table entry) and press [Enter].
5. Type the number of the User-based Security Model (USM) SNMPv3 user to modify and press [Enter].
6. Type the SNMPv3 user's name and press [Enter].



NOTE When the authentication password or privacy key (or both) are not required, ignore the error message indicating a failure at password verification.

7. Type the old authentication password and/or [Enter] (if not required). The old password is the currently configured password value. The value is checked before allowing its modification.
8. Type the new authentication password and/or [Enter] (if not required), with 8 to 24 characters allowed.
9. Type the old privacy key and/or [Enter] (if not required). The old password is the currently configured password value. The value is checked before allowing its modification.
10. Type the new privacy key and/or [Enter] (if not required), with 8 to 24 characters allowed.

11. Choose the security level applied to the SNMPv3 user as follows:
 - **Disabled:** The SNMPv3 user is disabled. Type **0** and press [Enter].
 - **No Auth No Priv:** No authentication password or privacy key is required to access the MIB objects. Type **1** and press [Enter].
 - **Auth No Priv:** An authentication password but no privacy key is required to access the MIB objects. Type **2** and press [Enter].
 - **Auth Priv:** An authentication password and a privacy key are required to access the MIB objects. Type **3** and press [Enter].
12. Choose the access rights allowed to the SNMPv3 user as follows:
 - **No access:** The SNMPv3 user is disabled and has no access to the MIB objects. Type **0** and press [Enter] (see Figure 71).
 - **Read-Only:** The SNMPv3 user can only get the MIB objects. Type **0** and press [Enter].
 - **Read/Write:** The SNMPv3 user can get and set the MIB objects. Type **0** and press [Enter].

```

+=====+
|  User Name          Auth. Password   Priv. Password   |
|  Security Level     Access              |
+=====+
[1] SNMPv3 User 1     *****
[1] noAuthNoPriv     No Access
[2] SNMPv3 User 2     *****
[2] noAuthNoPriv     No Access
[3] SNMPv3 User 3     *****
[3] noAuthNoPriv     No Access
[4] SNMPv3 User 4     *****
[4] noAuthNoPriv     No Access

  COMMANDS -
  1. Modify - Modify a table entry
  2. Reset - Reset a table entry to default
  0. Return to previous menu

Please enter your choice =>

```

Figure 71. SNMPv3 USM Users Definition

Restore Factory Defaults

To reset the SNMPv3 user's settings by restoring the factory default settings for the USM user:

1. Access the Serial interface and log in.
2. Type **1** (Network Management Card Settings) and press [Enter].
3. Type **5** (SNMPv3 USM Table) and press [Enter].
4. Type **2** (Reset - Reset a table entry to default) and press [Enter].

Type the number of the SNMPv3 user to reset and press [Enter].

Date and Time

The ePDU date and time can be configured from the remote interfaces, from the SNMP agent, or either manually or automatically from a network NTP server.

Manually Configure the Date and Time

1. Access the Serial interface and log in.
2. Type **1** (Network Management Card Settings) and press [Enter].
3. Type **6** (Date and Time) and press [Enter].
4. Type **7** (Date Display Format) and press [Enter].
5. Choose the date format by typing **1, 2, 3,** or **4** and press [Enter].
6. Type **6** (NTP Control) and press [Enter].
7. Type **0** (Disabled) and press [Enter].
8. Type **1** (System Date) and press [Enter].
9. Type the system date and press [Enter]. The date format is *yyyy-mm-dd*, where *yyyy* = year, *mm* = month, and *dd* = day.
10. Type **2** (System Time) and press [Enter].
11. Type the system time and press [Enter]. The time format is *hh:mm:ss*, where *hh* = hours, *mm* = minutes, and *ss* = seconds.

```

+-----+
|                                     |
|                                     |
+-----+
System Up since: 1 hour 8 min 25 sec

  1. System Date           : 2011-05-23
  2. System Time (hh:mm:ss) : 10:56:01
  3. NTP Server            :
  4. NTP Time Zone         : +01:00
  5. Daylight Saving Time Control : Disabled
  6. NTP Control           : Disabled
  7. Date Display Format    : yyyy-mm-dd
  0. Return to previous menu

Please enter your choice =>

```

Figure 72. Date and Time Configuration

Configure the Date and Time Automatically

1. Access the Serial interface and log in.
2. Type **1** (Network Management Card Settings) and press [Enter].
3. Type **6** (Date and Time) and press [Enter].
4. Type **7** (Date Display Format) and press [Enter].
5. Choose the date format by typing **1, 2, 3** or **4** and press [Enter].
6. Type **6** (NTP Control) and press [Enter].
7. Type **1** (Enabled) and press [Enter].

8. Type **4** (NTP Time Zone) and press [Enter].
9. Type the time zone offset and press [Enter]. The format is *+/-hh:mm*, where *hh* = hours and *mm* = minutes.



NOTE Always set the sign (+ or -) with two digits for hours and minutes. Entering 2:00 or 1:00 will be rejected.

10. Type **5** (Daylight Saving Time Control) and press [Enter].
11. To disable or enable Daylight Saving Time:
 - **Disable:** Type **0** and press [Enter] to disable this option
 - **Enable:** Type **1** and press [Enter] to enable this option.
12. Type **3** (NTP Server) and press [Enter].
13. Type the NTP server IPv4/IPv6 address or host name and press [Enter].



NOTE The Network Management Card retrieves the date and time from the configured NTP server every hour.

Email Notifications

Configure Email Notifications

1. Access the Serial interface and log in.
2. Type **1** (Network Management Card Settings) and press [Enter].
3. Type **7** (Email Notifications) and press [Enter].
4. Type **1** (Mail Server) and press [Enter].
5. Type the IPv4/IPv6 address or host name of the Simple Mail Transfer Protocol (SMTP) server and press [Enter].

9. Do you want to attach the event log file to the e-mail sent to this receiver?
 - If yes, type **1** (Enabled) and press [Enter].
 - If no, type **0** (Disabled) and press [Enter].
10. What type of alarm notification do you want to provide to the e-mail receiver?
 - To always send a notification when an alarm is generated or is resolved, perform the following:
 - If yes, type **1** (All Alarms) and press [Enter].
 - If no, type **0** (Disabled) and press [Enter].
 - To send periodic e-mails, perform the following:
 - Set the date of the next report by entering a day of the month and press [Enter]. For example, entering 4 means the 4th day of the current month if the current system date is before this date. If the current system date is higher than 4, this means the 4th day of the next month.
 - Type the frequency of report in days and press [Enter]. For example, 7 means every 7 days.
 - Choose the hour to send the report and press [Enter]. The format is *hh:00*, where *hh* = hour. The 24-hour range is 00:00–23:00.

**NOTE**

You cannot remove or change an e-mail address associated with a user using the serial interface. Use the Web interface to perform this action.

```

+=====+
| Mail Account   State Type   LogsFile  Period Time  NextRep Desc  Att..|
+=====+
[1] email1@Recip... Ena... Dis... Disabled  0    00:00 19    The... user1
[2] email2@Recip... Dis... Dis... Disabled  0    00:00 0
[3] email3@Recip... Dis... Dis... Disabled  0    00:00 0
[4] email4@Recip... Dis... Dis... Disabled  0    00:00 0
[5] email5@Recip... Dis... Dis... Disabled  0    00:00 0
[6] email6@Recip... Dis... Dis... Disabled  0    00:00 0
[7] email7@Recip... Dis... Dis... Disabled  0    00:00 0
[8] email8@Recip... Dis... Dis... Disabled  0    00:00 0

COMMANDS -
1. Detail - View the details of a table entry
2. Modify - Modify a table entry
3. Test - Send a test email to an email account
4. Reset - Reset a table entry to default
0. Return to previous menu

Please enter your choice => _

```

Figure 74. Email Receiver Configuration

```

Please enter your choice => 1
Entry number: 1
Mail Account           : email1@Recipient1.com
Mail Account State    : Enabled
Mail Type              : Disabled
Attached logs file     : Disabled
Report Periodicity    : 0
Report Hour            : 00:00
Date of Next Report   : 19
Description           : The user1' e-mail address
User                  : user1

<enter any key to continue>

```

Figure 75. Details of Table Entry for an Email Receiver (Command Selection 1)

Test Email

This action consists of sending a test e-mail to the selected e-mail receiver.

To achieve this action, the following requirements must be met:

- The Network Management Card is running in normal Operation mode.
- The Network Management Card is connected to the LAN.
- The Network Management Card owns a valid IP address.
- The optional SMTP server authentication login and password are configured (if required).
- The DNS servers (primary and optional secondary) for Domain Name Systems (DNS) must be configured if the SMTP server is configured with the hostname.

The target e-mail receiver configuration requires a valid e-mail receiver account and the account must be enabled.



NOTE See "Email Notifications" on page 113.

Superuser Name and Password

1. Access the Serial interface and log in.
2. Type **1** (Network Management Card Settings) and press [Enter].
3. Type **8** (Super User Name and Password) and press [Enter].
4. Type **1** (Super User Username) and press [Enter].
5. Type the Superuser name and press [Enter] (see Figure 76).
6. Type **2** (Super User Password) and press [Enter].
7. Type the current Superuser password and press [Enter].
8. Type the new Superuser password and press [Enter].
9. Type the new Superuser password again and press [Enter].

```

+-----+
|                                     |
|                       EATON ePDU Configuration Utility                       |
|                                     |
+-----+
1. Super User Username       : admin
2. Super User Password      : *****
0. Return to previous menu

Please enter your choice =>

```

Figure 76. Superuser Configuration

Multi-Users

1. Access the Serial interface and log in.
2. Type **1** (Network Management Card Settings) and press [Enter].
3. Type **9** (Multi-Users) and press [Enter].
4. Type **1** (Modify – Modify a table entry) and press [Enter].
5. Type the number of the user to configure and press [Enter].
6. Type the user name and press [Enter].
7. Type the current user’s password and press [Enter].
8. Type the new user’s password and press [Enter].
9. Type the new user’s password again and press [Enter].
10. Select the access rights from the following:
 - **No Access:** The user is not allowed to access the Web interface. Type **0** and press [Enter].
 - **Read-Only:** The user can access the Web interface, but is not allowed to change any settings or perform actions. Type **1** and press [Enter].
 - **Read/Write:** The user can access the Web interface and is allowed to change settings but not to perform actions. Type **2** and press [Enter].
 - **Read/Write/Control:** The user can access the Web interface and is allowed to change settings and to perform actions. Type **3** and press [Enter].



NOTE

You cannot associate groups with users using the Serial interface. Use the Web interface to perform this action.

	User Name	Password	Access Type	Attribute Groups...
[1]	user1	*****	Read/Write/Control	Enabled
[2]	User 2	*****	No Access	Disabled
[3]	User 3	*****	No Access	Disabled
[4]	User 4	*****	No Access	Disabled
[5]	User 5	*****	No Access	Disabled
[6]	User 6	*****	No Access	Disabled
[7]	User 7	*****	No Access	Disabled
[8]	User 8	*****	No Access	Disabled

COMMANDS -

1. Modify - Modify a table entry
2. Reset - Reset a table entry to default
0. Return to previous menu

Please enter your choice =>

Figure 77. Multi-User Configuration

EnergyWise Settings

1. Access the Serial interface and log in.
2. Type **1** (Network Management Card Settings) and press [Enter].
3. Type **10** (EnergyWise Settings) and press [Enter].
4. Type **1** (Domain), type the EnergyWise name used in your network, and press [Enter].
5. Do you want to enable or disable password authentication for communication between the domain member and endpoints in an EnergyWise domain?
 - To disable password authentication, type **2** (Secret Control), type **Disabled**, and press [Enter].
 - To enable password authentication:
 - Type **2** (Secret Control), type **Enabled**, and press [Enter].
 - Type **3** (Secret), type the password to be used in the EnergyWise domain, and press [Enter].
6. Type **4** (Remote Port), type the port number for the remote port used by domain members to communicate with the endpoints, and press [Enter].
7. Type **5** (Listen Port), type the local port number of the endpoint used to communicate with the domain members.
8. Type **6** (Level), type the threshold level, press [Enter].
9. Type **7** (State), type the EnergyWise state agent of the ePDU (enabled or disabled), and press [Enter].
10. Type **0** (Return to previous menu) and press [Enter].
11. Type **3** (Restart Network Management Card) and press [Enter].
12. Type **Y** and press [Enter]. The Network Management Card restarts.

Chapter 9 Maintenance and Troubleshooting

This section explains maintenance functions for the Eaton Advanced Enclosure Power Distribution Unit (ePDU), including:

- Preventive maintenance
- Equipment disposal
- Network Management Card firmware upgrade
- Troubleshooting

Preventive Maintenance

For the best preventive maintenance, keep the area around the ePDU clean and dust-free. If the atmosphere is very dusty, clean the outside of the system with a vacuum cleaner. For full life, keep the ePDU at an ambient temperature of 25°C (77°F).



NOTE The ePDU does not contain any serviceable parts.

Equipment Disposal

Contact your local recycling or hazardous waste center for information on proper disposal of the used ePDU.



CAUTION

Do not discard waste electrical or electronic equipment (WEEE) in the trash. For proper disposal, contact your local recycling/reuse or hazardous waste center.

Network Management Card Firmware Upgrade

The Network Management Card firmware upgrade process allows you to maintain the most current Network Management Card firmware by updating the Network Management Card with new or enhanced features and applying periodic bug fixes.

To begin the upgrade process, the Network Management Card must be in the appropriate Operation mode to accept the new firmware upgrade files. You can initiate the appropriate Firmware Upgrade mode remotely using user interface software. You can also reconfigure dual in-line package (DIP) switches on the ePDU front panel and force the Network Management Card into Firmware Upgrade mode locally.

The new firmware files are uploaded from the Local Area Network (LAN) using an MS-DOS File Transfer Protocol (FTP). To transfer the new firmware version file to the appropriate Network Management Card, you must know the IPv4 or IPv6 address of the Network Management Card you are preparing to upgrade. This address is required whether you enable the Firmware Upgrade mode remotely or locally.

To upgrade the Network Management Card firmware:

1. Enable the Firmware Upgrade mode remotely or locally.
2. Upload the new version firmware files using the FTP.
3. Exit Firmware Upgrade mode and return to normal operation by restarting the Network Management Card.

For the most current firmware upgrade files, visit <http://powerquality.eaton.com/Support/SoftwareDrivers>.

Enable Firmware Upgrade Mode

Firmware Upgrade mode can be initiated with software using either the Web interface or Serial interface. Firmware Upgrade mode can also be enabled using dual in-line package (DIP) switch hardware settings.



IMPORTANT

Before enabling the Firmware Upgrade mode, determine the IPv4 address of the ePDU you intend to upgrade.

Web Interface

To enable Firmware Upgrade mode from the Web interface:

1. Access the interface (see Chapter 7, “Web Interface Operation” on page 79).
2. Browse to the Network page.
3. Note the IPv4 address.
4. Browse to the System page.
5. Check the box labeled **Firmware Upgrade Enabled**.
6. Click **Save** and then click **Yes** in the confirmation window (see Figure 79).

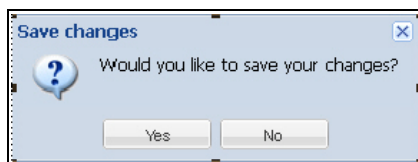

Figure 79. Save Changes Confirmation Window

7. Click the **Upgrade** Network Management Card button.
8. Click **Yes** in the confirmation window (see Figure 80).

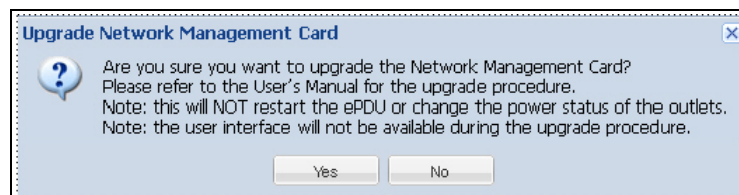

Figure 80. Upgrade Network Management Card Confirmation Window

9. The Network Management Card restarts automatically in the Firmware Upgrade mode. Continue to “Upload New Firmware Files” on page 123.

DIP Switch Configuration

To force Firmware Upgrade mode using hardware settings:

1. Obtain the IPv4 or IPv6 address (see “Obtaining the IPv4 Address” on page 28 or “Obtaining the IPv6 Address” on page 31). The IP address is used in the “Upload New Firmware Files” procedure.



NOTE

If you do not enter an IP address during the upload procedure, the Network Management Card defaults to the last known address. By default, the initial startup IPv4 address is 192.168.123.123.

1. Reset the DIP switches to the Network Management Card Firmware Upgrade mode, with setting Switch 1/ON and Switch 2/OFF.
2. Insert a probe in the Reset opening (labeled R) on the ePDU front panel. Press the recessed Restart button and retract the probe. The Network Management Card restarts (see Figure 87).
3. The Network Management Card restarts in Firmware Upgrade mode. Continue to the following section, “Upload New Firmware Files”.

Upload New Firmware Files

After the Firmware Upgrade mode is enabled, the Network Management Card can be upgraded using an executable tool (exe file). The upgrade process uploads the new Network Management Card firmware version (binary file), a configuration file or files that are stored in the Network Management Card file system, and the Web interface files.

To upload the new firmware files to the specified Network Management Card:

1. Click the firmware upgrade file icon (Nemo_UpgradeTool_b2_Firmware_<version number>.exe):
Example: To upgrade to firmware version 01.01.0007, click the Nemo_UpgradeTool_b2_Firmware_01_01_0007.exe icon.
2. Type the IP address and press [Enter].



NOTE

Type the IP address obtained in the previous procedure or use the default IP address.

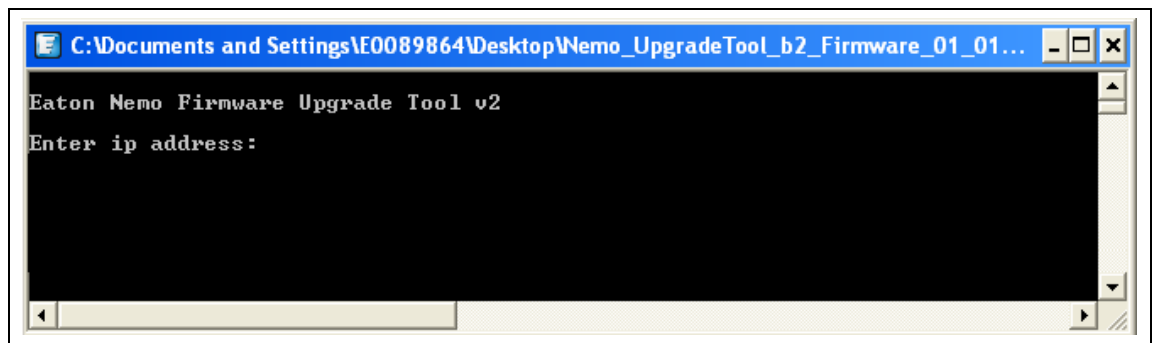

Figure 82. IP Address Entry

3. Type the Superuser login and press [Enter].

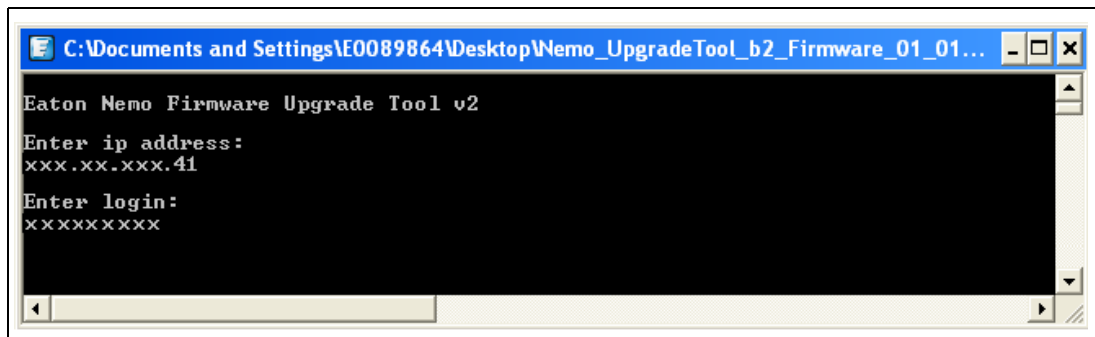

Figure 83. Login Entry

4. Type the Superuser password and press [Enter] (see Figure 84).

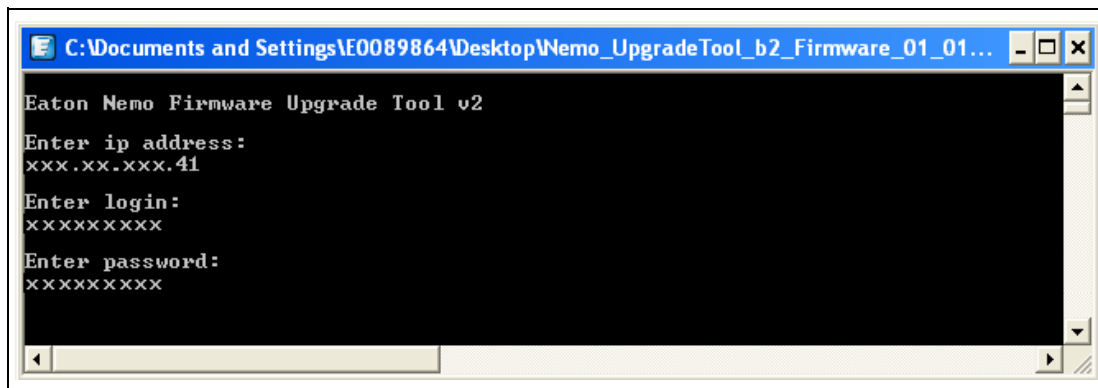

Figure 84. Enter Password

5. Review the system status display as the firmware upgrade begins processing (see Figure 85).

```

Eaton Nemo Firmware Upgrade Tool v2
Enter ip address:
xxx.xx.xxx.41
Enter login:
xxxxxxxxxx
Enter password:
xxxxxxxxxx
Set device in bootloader successfully.
Upload file: 'upgrade.txt' (363 bytes)...
Upload file: 'eaton/images/advancedManaged.png' (7714 bytes)...
Upload file: 'eaton/images/eaton.png' (1717 bytes)...
Upload file: 'eaton/images/entete.png' (7888 bytes)...
Upload file: 'eaton/images/favicon.png' (3962 bytes)...
Upload file: 'eaton/images/managed.png' (4984 bytes)...
Upload file: 'eaton/images/switched.png' (4977 bytes)...
Upload file: 'eaton/images/drop-yes.gif' (1016 bytes)...
Upload file: 'eaton/images/elbow-minus-nl.gif' (898 bytes)...
Upload file: 'eaton/images/elbow-plus-nl.gif' (900 bytes)...
Upload file: 'eaton/images/exclamation.gif' (996 bytes)...
Upload file: 'eaton/images/left2.gif' (920 bytes)...
Upload file: 'eaton/images/off.gif' (610 bytes)...
Upload file: 'eaton/images/on.gif' (604 bytes)...
Upload file: 'eaton/images/panel-handle.gif' (830 bytes)...
Upload file: 'eaton/images/right2.gif' (925 bytes)...
Upload file: 'eaton/images/row-editor-bg.gif' (819 bytes)...
Upload file: 'eaton/images/row-editor-btms.gif' (1087 bytes)...
Upload file: 'eaton/images/spinner-split.gif' (49 bytes)...
Upload file: 'eaton/images/spinner.gif' (3186 bytes)...
Upload file: 'eaton/images/state1.gif' (525 bytes)...
Upload file: 'eaton/images/state2.gif' (526 bytes)...
Upload file: 'eaton/images/state3.gif' (522 bytes)...
Upload file: 'eaton/images/state4.gif' (528 bytes)...
Upload file: 'eaton/images/summary-bg.gif' (811 bytes)...
Upload file: 'eaton/images/summary-group-bg.gif' (819 bytes)...
Upload file: 'eaton/images/treeicon_powersource.gif' (1021 bytes)...
Upload file: 'eaton/images/treeicon_syslog.gif' (1017 bytes)...
Upload file: 'eaton/images/treeicon_system.gif' (1048 bytes)...
Upload file: 'eaton/images/x-grouptabs-corners.gif' (1080 bytes)...
Upload file: 'eaton/html/index.html' (5867 bytes)...
Upload file: 'eaton/html/redirect.html' (568 bytes)...
Upload file: 'eaton/js/Nemo.js' (434472 bytes)...
upload: 14%
upload: 28%
upload: 42%
upload: 56%
upload: 70%
upload: 82%
upload: 93%
Upload file: 'extjs/resources/images/default/button/arrow.gif' (828 bytes)...
Upload file: 'extjs/resources/images/default/button/btn.gif' (4298 bytes)...
Upload file: 'extjs/resources/images/default/button/group-cs.gif' (2459 bytes)...
Upload file: 'extjs/resources/images/default/button/group-lr.gif' (861 bytes)...
Upload file: 'extjs/resources/images/default/button/group-th.gif' (846 bytes)...
Upload file: 'extjs/resources/images/default/button/s-arrow-b-noline.gif' (898 bytes)...
Upload file: 'extjs/resources/images/default/button/s-arrow-b.gif' (937 bytes)...
Upload file: 'extjs/resources/images/default/button/s-arrow-bo.gif' (139 bytes)...
Upload file: 'extjs/resources/images/default/button/s-arrow-noline.gif' (863 bytes)...
Upload file: 'extjs/resources/images/default/button/s-arrow-o.gif' (937 bytes)...
Upload file: 'extjs/resources/images/default/button/s-arrow.gif' (937 bytes)...
Upload file: 'extjs/resources/images/default/form/checkbox.gif' (2061 bytes)...
Upload file: 'extjs/resources/images/default/form/clear-trigger.gif' (1988 bytes)...
Upload file: 'extjs/resources/images/default/form/date-trigger.gif' (1603 bytes)...
Upload file: 'extjs/resources/images/default/form/error-tip-corners.gif' (4183

```

Figure 85. Begin Upgrade Status Display

- When the firmware upgrade ends, review the status display to confirm that the update completed successfully (see Figure 86). You exit the Firmware Upgrade mode when the Network Management Card restarts automatically and returns Network Management Card operation to the state represented by the DIP switches.

```

C:\Documents and Settings\E0089864\Desktop\Nemo_UpgradeTool_b2_Firmware_01_01...
Upload file: 'extjs/resources/images/default/window/icon-question.gif' (1607 by
Upload file: 'extjs/resources/images/default/window/icon-warning.gif' (1483 byt
Upload file: 'extjs/resources/images/default/window/left-corners.png' (200 byte
Upload file: 'extjs/resources/images/default/window/left-right.png' (152 bytes)
Upload file: 'extjs/resources/images/default/window/right-corners.png' (256 byt
Upload file: 'extjs/resources/images/default/window/top-bottom.png' (180 bytes)
Upload file: 'extjs/resources/images/default/shared/hd-sprite.gif' (1099 bytes)
Upload file: 'extjs/resources/images/default/shared/left-btn.gif' (870 bytes)..
Upload file: 'extjs/resources/images/default/shared/right-btn.gif' (871 bytes)..
Upload file: 'extjs/resources/images/default/menu/checked.gif' (959 bytes)...
Upload file: 'extjs/resources/images/default/menu/group-checked.gif' (891 bytes)
Upload file: 'extjs/resources/images/default/menu/item-over.gif' (820 bytes)...
Upload file: 'extjs/resources/images/default/menu/menu-parent.gif' (854 bytes)..
Upload file: 'extjs/resources/images/default/menu/menu.gif' (834 bytes)...
Upload file: 'extjs/resources/images/default/menu/unchecked.gif' (941 bytes)...
Upload file: 'extjs/resources/images/default/gradient-bg.gif' (1472 bytes)...
Upload file: 'extjs/resources/images/default/s.gif' (43 bytes)...
Upload file: 'extjs/resources/images/default/shadow-c.png' (118 bytes)...
Upload file: 'extjs/resources/images/default/shadow-lr.png' (135 bytes)...
Upload file: 'extjs/resources/images/default/shadow.png' (311 bytes)...
Upload file: 'extjs/resources/css/ext-all.css' (138472 bytes)...
upload: 43%
upload: 87%
Upload file: 'extjs/ext-all.js' (714418 bytes)...
upload: 8%
upload: 17%
upload: 26%
upload: 34%
upload: 43%
upload: 50%
upload: 57%
upload: 64%
upload: 71%
upload: 78%
upload: 85%
upload: 92%
upload: 99%
Upload file: 'extjs/ext-base.js' (27115 bytes)...
Upload file: 'ws/EATON-EPDU-MIB.zip' (11146 bytes)...
Upload file: 'ws/get_object.html' (7609 bytes)...
Upload file: 'ws/summary.html' (7606 bytes)...
Upload file: 'Firmware.bin' (1032256 bytes)...
upload: 6%
upload: 12%
upload: 17%
upload: 23%
upload: 29%
upload: 33%
upload: 39%
upload: 43%
upload: 49%
upload: 55%
upload: 59%
upload: 64%
upload: 68%
upload: 74%
upload: 80%
upload: 84%
upload: 90%
upload: 94%
upload: 100%
Reboot device...

Update completed successfully
*** Hit [ENTER] key to terminate...

```

Figure 86. End Upgrade Status Display

Restart the Network Management Card

If you initiated the Network Management Card firmware upgrade using either the Web interface or the Serial interface, the Network Management Card restarts automatically to the existing state according to the configuration of the DIP switches.

If you forced the Network Management Card Firmware Upgrade mode by the hardware setting of the DIP switches, a two-step procedure is required to restart the Network Management Card.

To restart the Network Management Card after a firmware upgrade forced by hardware settings:

1. Reset the DIP switches to one of the following modes:
 - Normal Operation mode, with setting Switch 1/OFF and Switch 2/OFF
 - Read-Only mode, with setting Switch 1/OFF and Switch 2/ON
2. Insert a probe in the Reset opening (labeled R) on the ePDU front panel. Press the recessed Restart button and retract the probe. The Network Management Card restarts (see Figure 87).

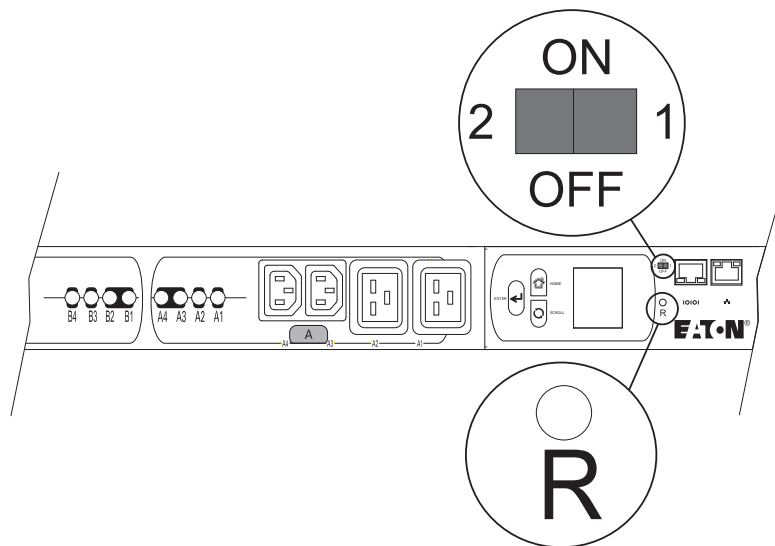

Figure 87. DIP Switches and Reset Opening on Front Panel

Troubleshooting

This section explains:

- How to acknowledge an alarm
- Types of alarms
- Typical alarms and conditions

Acknowledging the Alarm

To clear blinking LCDs and the LED: On the ePDU, touch any button or clear the alarm using the Web interface.

To clear the Alarm in the event log: On the LCD screen, drill to the menu item “CLEAR EVENT LOG” and select Yes.

To correct a condition: Define the alarm condition and resolve the condition.

Self-correcting conditions: Sometimes, the alarm automatically clears when the condition resolves. For example, if a load over current alarm is generated, the alarm is cleared when the current drops 0.25A below the level (alarm hysteresis).



NOTE The screensaver turns off when an alarm is generated.

Types of Alarms

The ePDU is designed for durable, automatic operation. If a potential operating problem occurs, the ePDU issues an alarm to alert you.

- Alarms are displayed on the LCD and recorded in the event log. During an active alarm, the LCD flashes amber until any button is pressed. If a power outlet LED on an Advanced Monitored (AM) or Managed (MA) model is involved, it flashes.
- Notices are indications of behavior reaching a set threshold, such as Output Over Voltage Warning. Notices are displayed on the LCD and recorded in the event log. Notices do not require a response.
- Events are conditions recorded in the event log as status information, such as Power On. Events do not require a response.

Alarms, notices, and events are recorded in the event log as records of when alerts occurred and, if applicable, when they were cleared.

Alarms, Notices, and Events

Table 19 describes the typical alarms, conditions, and event notifications (notices).



NOTE For delta-configured models, L1 represents L1-L3 data, L2 represents L1-L2 data, and L3 represents the calculation $\sqrt{L^2 - L1 L2 + L2^2}$ data.

Table 19. Alarms, Notices, and Events

Alarm Number: Name	Description	Type
008: Frequency Out of Range	Utility frequency greater or less than +/- 3 Hz of Nominal frequency.	Notice
018: Contact 2 Active	The signal for Dry Contact 2 is active. Generates an alarm and is logged in the event log.	Alarm
019: Dry Contact 1 Active	The signal for Dry Contact 1 is active. Generates an alarm and is logged in the event log.	Alarm
053: Fatal EEPROM Fault	This alarm occurs when the EEPROM experiences a Range Check Failure alarm, an incorrect EEPROM model map alarm, or an EEPROM Checksum Failure alarm. Generates an alarm and is logged in the event log.	Alarm
063: Meter IC Fault	Communication is lost. This is probably due to Meter IC damage or the DIN/DOUT photo damage. Generates an alarm and is logged in the event log.	Alarm
102: L1 Over Current Critical	The Phase 1 input current amperage (A) reading is greater than the value configured as the over current critical alarm threshold. Generates an alarm and is logged in the event log.	Alarm

Table 19. Alarms, Notices, and Events (Continued)

Alarm Number: Name	Description	Type
103: L2 Over Current Critical	The Phase 2 input current amperage (A) reading is greater than the value configured as the over current critical alarm threshold. Generates an alarm and is logged in the event log.	Alarm
104: L3 Over Current Critical	The Phase 3 input current amperage (A) reading is greater than the value configured as the over current critical alarm threshold. Generates an alarm and is logged in the event log.	Alarm
181: ePDU Control Power ON	The ePDU processor is powered on. Logged in the event log only.	Event
200: Internal Temperature Critical	The temperature level reading is greater than the maximum temperature threshold value. Generates an alarm and is logged in the event log.	Alarm
203: Over Temperature Critical	The temperature level reading is greater than the maximum critical temperature threshold value. Generates an alarm and is logged in the event log.	Alarm
291: L1 Under Voltage Warning	The Phase 1 voltage reading is less than the value configured as the low voltage warning threshold. Generates an alarm and is logged in the event log.	Notice
292: L2 Under Voltage Warning	The Phase 2 voltage reading is less than the value configured as the low voltage warning threshold. Generates an alarm and is logged in the event log.	Notice
293: L3 Under Voltage Warning	The Phase 3 voltage reading is less than the value configured as the low voltage warning threshold. Generates an alarm and is logged in the event log.	Notice
294: L1 Over Voltage Critical	The Phase 1 voltage reading is greater than the value configured as the over voltage critical alarm threshold. Generates an alarm and is logged in the event log.	Alarm
295: L2 Over Voltage Critical	The Phase 2 voltage reading is greater than the value configured as the over voltage critical alarm threshold. Generates an alarm and is logged in the event log.	Alarm
296: L3 Over Voltage Critical	The Phase 3 voltage reading is greater than the value configured as the over voltage critical alarm threshold. Generates an alarm and is logged in the event log.	Alarm
330: Over Humidity Critical	The humidity level reading is greater than the minimum humidity threshold. Generates an alarm and is logged in the event log.	Alarm
338: L1 Over Current Warning	The Phase 1 current amperage (A) reading is greater than the value configured as the over current warning threshold. Generates an alarm and is logged in the event log.	Notice
339: L2 Over Current Warning	The Phase 2 input current amperage (A) reading is greater than the value configured as the over current warning threshold. Generates an alarm and is logged in the event log.	Notice
340: L3 Over Current Warning	The Phase 3 input current amperage (A) reading is greater than the value configured as the over current warning threshold. Generates an alarm and is logged in the event log.	Notice

Table 19. Alarms, Notices, and Events (Continued)

Alarm Number: Name	Description	Type
343: Output Over Current Warning	Output current amperage (A) reading is greater than the value configured as the over current warning threshold. Generates an alarm and is logged in the event log.	Notice
344: Output Over Current Critical	Output current amperage (A) reading is greater than the value configured as the over current critical alarm threshold. Generates an alarm and is logged in the event log.	Alarm
345: Output Under Voltage Warning	Output voltage reading is less than the value configured as the low voltage warning threshold. Generates an alarm and is logged in the event log.	Notice
346: Output Over Voltage Critical	Output voltage reading is greater than the value configured as the high voltage critical alarm threshold. Generates an alarm and is logged in the event log.	Alarm
347: Over Temperature Warning	The temperature level reading is greater than the warning temperature threshold value. Generates an alarm and is logged in the event log.	Notice
348: Over Humidity Warning	The humidity level reading is greater than the value configured as the warning humidity threshold. Generates an alarm and is logged in the event log.	Notice
349: Internal Temperature Warning	The temperature level reading is greater than the warning temperature threshold value. Generates an alarm and is logged in the event log.	Notice
354: L1 Over Voltage Warning	The Phase 1 voltage reading is greater than the value configured as the over voltage warning threshold. Generates an alarm and is logged in the event log.	Notice
355: L2 Over Voltage Warning	The Phase 2 voltage reading is greater than the value configured as the over voltage warning threshold. Generates an alarm and is logged in the event log.	Notice
356: L3 Over Voltage Warning	The Phase 3 voltage reading is greater than the value configured as the over voltage warning threshold. Generates an alarm and is logged in the event log.	Notice
361: Group Under Current Critical	Group input current amperage (A) reading is greater than the value configured as the low current critical alarm threshold. Generates an alarm and is logged in the event log.	Alarm
362: Group Over Current Warning	Group current amperage (A) reading is greater than the value configured as the over current warning threshold. Generates an alarm and is logged in the event log.	Notice
363: Group Over Current Critical	Group current amperage (A) reading is greater than the value configured as the over current critical alarm threshold. Generates an alarm and is logged in the event log.	Notice
411: Circuit Breaker Has Tripped	Generates an alarm and is logged in the event log.	Alarm

Table 19. Alarms, Notices, and Events (Continued)

Alarm Number: Name	Description	Type
User Defined Group Under Current Critical	User-defined group input current amperage (A) reading is greater than the value configured as the low current critical alarm threshold. Generates an alarm and is logged in the event log.	Alarm
User Defined Group Over Current Warning	User-defined group current amperage (A) reading is greater than the value configured as the over current warning threshold. Generates an alarm and is logged in the event log.	Notice
User Defined Group Over Current Critical	User-defined group current amperage (A) reading is greater than the value configured as the over current critical alarm threshold Generates an alarm and is logged in the event log.	Notice

Events

The following events are reported:

- User <Login> logged in by <Interface>
- User <Login> logged out by <Interface>
- User <Login> failed to log by <Interface>
- Switch to bootloader mode for upgrade by <Interface>
- Send test mail to <Recipient> succeed
- Send test mail to <Recipient> failed
- Time changed by user with <Date Time>
- Network Management Card restarted
- Network Management Card restart requested by <Interface>
- Factory reset requested by <Interface>
- Environment probe connected
- Environment probe disconnected
- PDU & System Log cleared
- Network cable not connected
- Network cable connected
- Network cable disconnected
- Network Management Card reset after error on system resource: ran out Quadnet simple heap
- Network Management Card reset after error on system resource: queue <Queue Name>
- Network Management Card cannot initiate communication with the PDU core
- Error on system resource: task <Task Name>
- Network Management Card cannot initiate communication with the ePDU core
- Outlet <iName> switched Off
- Outlet <iName> switched On
- Environment Dry Contact 1 state is 0
- Environment Dry Contact 1 state is 1
- Environment Dry Contact 2 state is 0

- Environment Dry Contact 2 state is 1
- Recovery access has been granted on serial connection. Verify access is authorized.

NOTE The task definitions used in the Event List are:



- <Login> = User Login
 - <Interface> = "HTTP," "Telnet," or "Serial"
 - <Recipient> = Recipient of the e-mail
 - <Date Time> = Logged date and time
 - <Queue Name> = "QUEUE_EMAIL," "QUEUE_TRAP," or "QUEUE_SET_HID."
 - <Task Name> = "TASK_HTTPD," "TASK_SHUT_HID," or "TASK_SHUT_HOST,"
"TASK_EMAIL," "TASK_TRAP," "TASK_PER_EMAIL," "TASK_SNTP,"
"TASK_SENSOR," "TASK_FILESYSTEM," "TASK_DISCOVERY,"
"TASK_LINK_STATUS," or "TASK_HTTPD_LIGHT."
 - <iName> = Identifying name of outlet
-

Chapter 10 Specifications

This chapter lists the following specifications for the Eaton Advanced Enclosure Power Distribution Unit (ePDU) models:

- Model list
- Weights and dimensions
- Electrical input and output
- Electrical ratings
- Overcurrent protection
- Environmental and safety

Model List

Table 20 lists the ePDU models and descriptions.

Table 20. Model List

Model	Description
eSWA01	ePDU 2.4kVA SW 1P C14 10A 0:16×C13
eSWA02	ePDU 3.8kVA SW 1P IEC 60309 16A 0:20×C13, 4×C19
eSWA03	ePDU 3.8kVA SW 1P C20 16A 0:20×C13, 4×C19
eSWA04	ePDU 7.7kVA SW 1P IEC 60309 32A 0:20×C13, 4×C19
eSWA05	ePDU 11.5kVA SW 3P IEC 60309 16A 0:21×C13, 3×C19
eAMA06	ePDU 2.4kVA AM 1P C14 10A 0:16×C13
eAMA07	ePDU 3.8kVA AM 1P IEC 60309 16A 0:20×C13, 4×C19
eAMA08	ePDU 3.8kVA AM 1P C20 16A 0:20×C13, 4×C19
eAMA09	ePDU 7.7kVA AM 1P IEC 60309 32A 0:20×C13, 4×C19
eMAA10	ePDU 2.4kVA MA 1P C14 10A 0:16×C13
eMAA11	ePDU 3.8kVA MA 1P IEC 60309 16A 0:20×C13, 4×C19
eMAA12	ePDU 3.8kVA MA 1P C20 16A 0:20×C13, 4×C19
eMAA13	ePDU 7.7kVA MA 1P IEC 60309 32A 0:20×C13, 4×C19
eMAA14	ePDU 11.5kVA MA 3P IEC 60309 16A 0:21×C13, 3×C19
eAM001	ePDU 5.8kVA AM 1P L6-30P 24A 0:20×C13, 4×C19
eAM002	ePDU 5.8kVA AM 3P L21-20P 16A 0:21×C13, 3×C19
eAM003	ePDU 12.6kVA AM 3P CS8365C 35A 0:21×C13, 3×C19
eAM004	ePDU 8.6kVA AM 3P L21-30P 24A 0:21×C13, 3×C19
eAM005	ePDU 17.3kVA AM 3P IEC 60309 48A 0:12×C13, 12×C19
eAM008	ePDU 3.3kVA AM 1P C20 16A 0:20×C13, 4×C19
eMA006	ePDU 5.8kVA MA 3P L21-20P 16A 0:21×C13, 3×C19
eMA007	ePDU 12.6kVA MA 3P CS8365C 35A 0:21×C13, 3×C19
eMA009	ePDU 17.3kVA MA 3P IEC 60309 48A 0:12×C13, 12×C19
eMA010	ePDU 5.8kVA MA 1P L6-30P 24A 0:20×C13, 4×C19
eMA011	ePDU 8.6kVA MA 3P L21-30P 24A 0:21×C13, 3×C19
eMA012	ePDU 3.3kVA MA 1P C20 16A 0:20×C13, 4×C19
eMA013	ePDU 11.5kVA MA 3P IEC 60309 16A 0:12×C13, 12×C19
eMA014	ePDU 17.3kVA MA 3P 24A 0:12×C13, 12×C19

Weights and Dimensions

Table 21 lists weights and dimensions for the ePDU models.

Table 21. Weights and Dimensions

Model	Weight	Length in millimeters (mm)	Width in millimeters (mm)	Depth in millimeters (mm)	Depth (outlet) in millimeters (mm)
eSWA01	3.73	1092.2	55	113	65
eSWA02	4.96	1524	55	113	65
eSWA03	4.89	1524	55	113	65
eSWA04	5.91	1727.2	55	113	65
eSWA05	5.31	1524	55	113	65
eAMA06	3.2	1092.2	55	113	65
eAMA07	4.67	1524	55	113	65
eAMA08	4.59	1524	55	113	65
eAMA09	5.6	1727.2	55	113	65
eMAA10	3.41	1092.2	55	113	65
eMAA11	5.04	1524	55	113	65
eMAA12	4.91	1524	55	113	65
eMAA13	5.92	1727.2	55	113	65
eMAA14	5.02	1524	55	113	65
eAM001	5.73	1727.2	55	113	65
eAM002	5.41	1524	55	113	65
eAM003	8.87	1727.2	55	113	65
eAM004	6.88	1727.2	55	113	65
eAM005	10.48	1840	55	113	65
eAM008	4.61	1524	55	113	65
eMA006	5.57	1524	55	113	65
eMA007	9.18	1727.2	55	113	65
eMA009	10.8	1840	55	113	65
eMA010	6.44	1727.2	55	113	65
eMA011	7.27	1727.2	55	113	65
eMA012	5	1524	55	113	65
eMA013	6.83	1727.2	55	113	65
eMA014	8.55	1840	55	113	65

NOTE Circuit breakers require an additional 25 mm (0.98") clearance.

Electrical Input and Output

Table 22 and Table 23 list the electrical input and output characteristics for the ePDU models.

Table 22. Electrical Input and Output (All ePDU Models)

Input Frequency	50/60 Hz \pm 3 Hz
Input Voltage Tolerance	+6% / -10%
Output Frequency	50/60 Hz
Output Voltage Range	See Table 24 on page 136.
Output Voltage Tolerance	+6% / -10%

Table 23. Electrical Input and Output (By Model)

Model	Type *	Phases	Input Cord	Detachable Input Cord (accessory) **	C13 Outlets	C19 Outlets
eSWA01	SW	1P	C14	—	16	
eSWA02	SW	1P	C20R	IEC 60309/C19	20	4
eSWA03	SW	1P	C20R	C20/C19	20	4
eSWA04	SW	1P	IEC 60309	—	20	4
eSWA05	SW	3P	IEC 60309	—	21	3
eAMA06	AM	1P	C14	—	16	
eAMA07	AM	1P	C20R	IEC 60309/C19	20	4
eAMA08	AM	1P	C20R	C20/C19	20	4
eAMA09	AM	1P	IEC 60309	—	20	4
eMAA10	MA	1P	C14	—	16	
eMAA11	MA	1P	C20R	IEC 60309/C19	20	4
eMAA12	MA	1P	C20R	C20/C19	20	4
eMAA13	MA	1P	IEC 60309	—	20	4
eMAA14	MA	3P	IEC 60309	—	21	3
eAM001	AM	1P	L6-30P	—	20	4
eAM002	AM	3P	L21-20P	—	21	3
eAM003	AM	3P	CS8365C	—	21	3
eAM004	AM	3P	L21-30P	—	21	3
eAM005	AM	3P	IEC 60309	460P9W	12	12
eAM008	AM	1P	C20R	C20/C19 L6-20P/C19	20	4
eMA006	MA	3P	L21-20P	—	21	3
eMA007	MA	3P	CS8365C	—	21	3
eMA009	MA	3P	IEC 60309	460P9W	20	12
eMA010	MA	3P	L6-30P	—	20	4
eMA011	MA	3P	L21-30P	—	21	3
eMA012	MA	1P	C20R	C20/C19 L6-20P/C19	20	4
eMA013	MA	3P	IEC 60309	516P6W	12	12

Table 23. Electrical Input and Output (By Model) (Continued)

Model	Type *	Phases	Input Cord	Detachable Input Cord (accessory) **	C13 Outlets	C19 Outlets
eMA014	MA	3P	IEC 60309	532P6W	12	12

* Type definitions: AM = Advanced Monitoring (outlet monitoring only); MA = Managed (outlet monitoring and control); SW = Switched (outlet control only)

** Detachable input cords have an input locking mechanism to secure the cord. See “Three-Phase Configurations” on page 37 for an explanation of input connector codes for three-phase configuration topologies.

Electrical Ratings

Table 24 and Table 25 list the electrical ratings for the ePDU models.

Table 24. Electrical Ratings

Model	Input Voltage	Output Voltage	Input Current (A)	Input Current Derated UL (A)	Maximum Power (kVA)
eSWA01	200–240V	200–240V	10	—	2.4
eSWA02	200–240V	200–240V	16	—	3.8
eSWA03	200–240V	200–240V	16	—	3.8
eSWA04	200–240V	200–240V	32	—	7.7
eSWA05	200–240V (L-N)/ 346–415V (L-L)	200–240V	16	—	11.5
eAMA06	200–240V	200–240V	10	—	2.4
eAMA07	200–240V	200–240V	16	—	3.8
eAMA08	200–240V	200–240V	16	—	3.8
eAMA09	200–240V	200–240V	32	—	7.7
eMAA10	200–240V	200–240V	10	—	2.4
eMAA11	200–240V	200–240V	16	—	3.8
eMAA12	200–240V	200–240V	16	—	3.8
eMAA13	200–240V	200–240V	32	—	7.7
eMAA14	200–240V (L-N)/ 346–415V (L-L)	200–240V	16	—	11.5
eAM001	200–240V	200–240V	30	24	5.8
eAM002	200–240V	200–240V	20	16	5.8
eAM003	200–240V	200–240V	50	35	12.6
eAM004	200–240V	200–240V	30	24	8.6
eAM005	200–240V	200–240V	60	48	17.3
eAM008	100–240V	100–240V	20	16	3.3
eMA006	200–240V	200–240V	20	16	5.8
eMA007	200–240V	200–240V	50	35	12.6
eMA009	200–240V	200–240V	60	48	17.3
eMA010	200–240V	200–240V	30	24	5.8
eMA011	200–240V	200–240V	30	24	8.6
eMA012	100–240V	100–240V	20	16	3.3
eMA013	200–240V/346–415V	200–240V (L-N)/ 346–415V (L-L)	20	16	11.5
eMA014	200–240V/346–415V	200–240V (L-N)/ 346–415V (L-L)	30	24	17.3

Table 25. Output Current Ratings (All ePDU Models)

Outlets	VDE	UL/CSA (Derated)
IEC 60320 C13	10A	12A
IEC 60320 C19	16A	16A

Overcurrent Protection

Table 26 lists the overcurrent protection requirements for the ePDU models with outlet groups protected by circuit breakers.

Table 26. Overcurrent Protection

Model	Breaker Quantity	Breaker Type	Breaker Rating (A)	Note
eSWA04	2	SP	16	IEC/EN 60934 clearance and creepage distance > 3 mm
eAMA09	2	SP	16	IEC/EN 60934 clearance and creepage distance > 3 mm
eMAA13	2	2P	16	IEC/EN 60934 clearance and creepage distance > 3 mm
eAM001	2	DP	20	UL 489/CSA C22.2 No. 5.1
eAM003	3	DP	20	UL 489/CSA C22.2 No. 5.1
eAM004	3	DP	20	UL 489/CSA C22.2 No. 5.1
eAM005	6	DP	20	UL 489/CSA C22.2 No. 5.1
eMA007	3	DP	20	UL 489/CSA C22.2 No. 5.1
eMA009	6	DP	20	UL 489/CSA C22.2 No. 5.1
eMA010	2	DP	20	UL 489/CSA C22.2 No. 5.1
eMA011	3	DP	20	UL 489/CSA C22.2 No. 5.1
eMA014	3	DP	20	UL 489/CSA C22.2 No. 5.1

Environmental and Safety

Table 27 lists the environmental specifications for all ePDU models.

Table 27. Environmental Specifications (All Advanced ePDU Models)

Operating Temperature (Room Ambient)	0°C to 50°C (32°F to 122°F)
Shipping and Storage Temperature	-25°C to 70°C (-13°F to 158°F)
Localized Air Temperature (Inside ePDU)	70°C (158°F) maximum
Relative Humidity	5–95% noncondensing
Operating Altitude	Up to 3,048m (10,000 ft) above sea level (derated for higher altitude applications)
Shipping and Storage Altitude	Up to 12,200m (40,000 ft) above sea level

Table 28 lists safety information for all ePDU models.

Table 28. Safety Specifications (All Advanced ePDU Models)

Safety Conformance	UL 60950-1, CSA 60950, C22.2 No.29 & No.31 (CSA), IEC/EN60950-1, NEC-NFPA 70
Safety Conformance (Breakers and Outlets)	Outlets: UL 498, IEC 60320-1 Breakers: UL 489
EMC (Class A), North American models	FCC 47 CFR 15, Subpart B: 2009; ICES-003
EMC (Class A), EMEA models	EN 55022: 2007, CISPR 22: 2008, EN 55024: 1998 + A2: 2003, CISPR24: 2002, AS/NZS CISPR 22: 2006

Table 29 lists the agency markings and country agency certifications for the ePDU models.

Table 29. Safety Standards and Country Agency Certification

Model	CE Mark/ EN 60950-1	cTUVus UL60950-1	CB IEC/ EN 60950-1	FCC Part 15 Subpart B: 2009	ICES (EMC Canada)*
eSWA01	—	—	•	•	•
eSWA02	—	—	•	•	•
eSWA03	—	—	•	•	•
eSWA04	—	—	•	•	•
eSWA05	—	—	•	•	•
eAMA06	—	—	•	•	•
eAMA07	—	—	•	•	•
eAMA08	—	—	•	•	•
eAMA09	—	—	•	•	•
eMAA10	—	—	•	•	•
eMAA11	—	—	•	•	•
eMAA12	—	—	•	•	•
eMAA13	—	—	•	•	•
eMAA14	—	—	—	•	•
eAM001	•	•	•	—	—
eAM002	•	•	—	—	—
eAM003	•	•	—	—	—
eAM004	•	•	—	—	—
eAM005	•	•	—	—	—
eAM008	•	•	•	—	—
eMA006	•	•	—	—	—
eMA007	•	•	—	—	—
eMA009	•	•	—	—	—
eMA010	•	•	•	—	—
eMA011	•	•	—	—	—
eMA012	•	•	•	—	—
eMA013	•	•	—	—	—
eMA014	•	•	—	—	—

* CAN/CSA-CEI/IEC CISPR22-10



NOTE

Outlets conform to the relevant outlet standard. For IEC 60320 C13 and IEC 60320 C19 outlets, the relevant standards are UL-498 and IEC 60320-1.

Chapter 11 Service and Support

If you have any questions or problems with the Eaton Advanced Enclosure Power Distribution Unit (ePDU), call your **Local Distributor** or the **Help Desk** at one of the following telephone numbers and ask for an ePDU technical representative:

United States: **1-800-356-5737**
Canada: **1-800-461-9166 ext 260**
All other countries: **Call your local service representative**

Please have the following information ready when you call for service:

- Model number
- Serial number
- Date of failure or problem
- Symptoms of failure or problem
- Customer return address and contact information

Ordering Optional and Spare Parts

Table 30 provides the Eaton catalog part number for ordering optional and spare parts for the ePDU. Contact your local service representative for more information.

Table 30. Optional and Spare Parts

Eaton Catalog Number	Optional or Spare Part	Description
KBLT01	Optional	Eaton Cable Tray
EMP001	Optional	Eaton Environmental Monitoring Probe
SPK001	Spare Part	Eaton ePDU Global Spare Part Kit
SPK002	Spare Part	Eaton 10-ft input cord C19-C20
SPK003	Spare Part	Eaton ePDU 10-ft input cord C19-IEC 60309