

User Guide



HP Officejet Pro 251dw



HP Officejet Pro 251dw Printer

User Guide

Copyright information

© 2013 Copyright Hewlett-Packard
Development Company, L.P.
Edition 1, 3/2013

Hewlett-Packard Company notices

The information contained in this document is subject to change without notice.

All rights reserved. Reproduction, adaptation, or translation of this material is prohibited without prior written permission of Hewlett-Packard, except as allowed under copyright laws.

The only warranties for HP products and services are set forth in the express warranty statements accompanying such products and services. Nothing herein should be construed as constituting an additional warranty. HP shall not be liable for technical or editorial errors or omissions contained herein.

Acknowledgements

Windows, Windows XP, and Windows Vista are U.S. registered trademarks of Microsoft Corporation.

ENERGY STAR and the ENERGY STAR mark are registered U.S. marks.

Safety information



Always follow basic safety precautions when using this product to reduce risk of injury from fire or electric shock.

1. Read and understand all instructions in the documentation that comes with the printer.
2. Observe all warnings and instructions marked on the product.
3. Unplug this product from wall outlets before cleaning.
4. Do not install or use this product near water, or when you are wet.
5. Install the product securely on a stable surface.
6. Install the product in a protected location where no one can step on or trip over the line cord, and the line cord cannot be damaged.
7. If the product does not operate normally, see [Solve a problem](#).
8. There are no user-serviceable parts inside. Refer servicing to qualified service personnel.

Contents

1 Get started

Accessibility.....	7
HP EcoSolutions (HP and the Environment).....	8
Understand the printer parts.....	9
Front view.....	9
Printing supplies area.....	10
Back view.....	10
Use the printer control panel.....	11
Overview of buttons and lights.....	11
Control panel display icons.....	12
Change printer settings.....	13
Select the mode.....	13
Change printer settings.....	14
Select paper.....	14
Recommended papers for printing.....	14
Recommended papers for photo printing.....	15
Tips for selecting and using paper.....	16
Load paper.....	16
Load standard-size paper.....	16
Load envelopes.....	17
Load cards and photo paper.....	18
Load custom-size paper.....	19
Insert a memory device.....	20
Install the accessories.....	21
Install the automatic two-sided printing accessory (duplexer).....	21
Install Tray 2.....	22
Configure trays.....	23
Turn on accessories in the printer driver.....	24
To turn on accessories (Windows).....	24
To turn on accessories (Mac OS X).....	24
Maintain the printer.....	25
Clean the exterior.....	25
Update the printer.....	25
Update the printer using the embedded web server.....	25
Update the printer using the printer control panel.....	25
Open the printer software (Windows).....	26
Turn the printer off.....	26
Restore factory defaults.....	26

2 Print

Print documents.....	27
Print documents (Windows).....	27
Print documents (Mac OS X).....	28

Print brochures.....	28
Print brochures (Windows).....	29
Print brochures (Mac OS X).....	29
Print on envelopes.....	30
Print on envelopes (Windows).....	30
Print on envelopes (Mac OS X).....	31
Print photos.....	31
Print photos on photo paper (Windows).....	31
Print photos on photo paper (Mac OS X).....	32
Print photos from a memory device	32
Print on special and custom-size paper.....	33
Print on special or custom-size paper (Windows).....	33
Print on special or custom-size paper (Mac OS X).....	34
Set up custom sizes (Mac OS X).....	34
HP ePrint.....	35
HP Wireless Direct.....	35
Turn on HP wireless direct printing.....	36
Print from a wireless-capable mobile device.....	36
Print from a wireless-capable computer.....	36
Print from a wireless-capable computer (Windows).....	37
Print from a wireless-capable computer (Mac OS X).....	37
Print on both sides (duplexing).....	37
View Print Resolutions.....	39
3 Web Services	
What are Web Services?.....	40
HP ePrint.....	40
Printer Apps.....	40
Set up Web Services.....	41
Set up Web Services using the HP printer software.....	41
Set up Web Services using the printer's control panel.....	41
Set up Web Services using the embedded web server.....	42
Use Web Services.....	42
HP ePrint.....	42
Print using HP ePrint.....	43
Find the printer's email address.....	43
Turn off HP ePrint.....	43
Printer Apps.....	43
Use Printer Apps.....	43
Manage Printer Apps.....	44
Turn off Printer Apps.....	44
Remove Web Services.....	44
4 Work with ink cartridges	
Information on ink cartridges and the printhead.....	45
Check the estimated ink levels.....	46
Print when one or more ink cartridges are depleted.....	46
Replace the ink cartridges.....	47
Store printing supplies.....	48
Anonymous Usage Information Storage.....	48

5 Solve a problem

HP support.....50

 Obtain electronic support.....51

 HP support by phone.....51

 Before you call.....51

 Phone support period.....52

 After the phone support period.....52

General troubleshooting tips and resources.....52

Solve printer problems.....53

 The printer shuts down unexpectedly.....53

 Alignment fails.....53

 The printer is not responding (nothing prints).....53

 The printer prints slowly.....54

 The printer is making some unexpected noises.....55

 Blank or partial page printed.....56

 Something on the page is missing or incorrect.....56

 Placement of the text or graphics is wrong.....57

Print quality troubleshooting.....57

Solve paper-feed problems.....62

Solve problems using Web Services and HP websites.....63

 Solve problems using Web Services.....64

 Solve problems using HP websites.....65

Solve memory device problems.....65

 The printer cannot read the memory device.....65

 The printer cannot read photos on the memory device.....65

Solve Ethernet network problems.....66

 General network troubleshooting.....66

Solve wireless problems.....66

 Basic wireless troubleshooting.....66

 Step 1 - Make sure the wireless (802.11) light is turned on.....67

 Step 2 - Restart components of the wireless network.....67

 Step 3 - Run the Print Wireless Network Test.....67

 Advanced wireless troubleshooting.....67

 Step 1 - Make sure your computer is connected to your network.....68

 Step 2 - Make sure that the printer is connected to your network.....69

 Step 3 - Make sure your computer is not connected to your network over a Virtual Private Network (VPN).....70

 Step 4 - Make sure the printer is online and ready.....70

 Step 5 - Make sure the wireless version of the printer is set as the default printer driver (Windows only).....71

 Step 6 - Check to see if the firewall software is blocking communication.....71

 After resolving the problems.....72

 Configure your firewall software to work with the printer.....72

Solve printer management problems.....73

 Embedded web server cannot be opened.....73

Troubleshoot installation issues.....74

 Hardware installation suggestions.....74

 HP software installation suggestions.....75

Solve network problems.....75

Understand the Printer Status Report.....76

Printhead maintenance.....	78
Clean the printhead.....	78
Calibrate the linefeed.....	79
Align the printhead.....	79
Reinstall the printhead.....	80
Understand the network configuration page.....	82
Clear jams.....	84
Clear paper jams.....	84
Avoid paper jams.....	86
A Technical information	
Warranty information.....	87
Hewlett-Packard limited warranty statement.....	88
Ink cartridge warranty information.....	89
Printer specifications.....	90
Physical specifications.....	90
Product features and capacities.....	90
Processor and memory specifications.....	91
System requirements.....	91
Network protocol specifications.....	91
Embedded web server specifications.....	91
Paper specifications.....	92
Understand specifications for supported paper.....	92
Set minimum margins.....	95
Guidelines for printing on both sides of a page.....	95
Print specifications.....	96
Web Services specifications.....	96
HP ePrint.....	96
Printer Apps.....	96
HP website specifications.....	96
Environmental specifications.....	96
Electrical specifications.....	97
Acoustic emission specifications.....	97
Memory device specifications.....	97
Memory card specifications.....	97
USB flash drives.....	97

Regulatory information.....	99
FCC statement.....	99
Notice to users in Korea.....	100
VCCI (Class B) compliance statement for users in Japan.....	100
Notice to users in Japan about the power cord.....	100
Noise emission statement for Germany.....	100
European Union Regulatory Notice.....	100
GS Declaration (Germany).....	102
Regulatory information for wireless products.....	102
Exposure to radio frequency radiation.....	102
Notice to users in Brazil.....	102
Notice to users in Canada.....	103
Notice to users in Taiwan.....	103
Notice to users in Mexico.....	104
Notice to users in Japan.....	104
Regulatory model number.....	104
Environmental product stewardship program.....	105
Paper use.....	105
Plastics.....	105
Material safety data sheets.....	105
Recycling program.....	105
HP inkjet supplies recycling program.....	105
Disposal of waste equipment by users in private households in the European Union.....	106
Power consumption.....	107
Chemical Substances.....	107
Battery information.....	107
Battery disposal in the Netherlands.....	107
Battery disposal in Taiwan.....	107
California Perchlorate Material Notice.....	108
RoHS notices (China only).....	108
Restriction of hazardous substance (Ukraine).....	108
Third-party licenses.....	109
B HP supplies and accessories	
Order printing supplies online.....	118
Supplies.....	118
Ink cartridges and printheads.....	118
HP paper.....	119
C Network setup	
Change basic network settings.....	120
View and print network settings.....	120
Turn the wireless radio on and off.....	120
Change advanced network settings.....	120
Set link speed.....	121
View IP settings.....	121
Change IP settings.....	121
Configure the printer's firewall settings.....	121
Creating and using firewall rules.....	121
Reset network settings.....	123

Set up the printer for wireless communication.....	123
Before you begin.....	123
Set up the printer on your wireless network.....	124
Set up the printer using the HP printer software.....	124
Set up the printer using the Wireless Setup Wizard.....	124
Set up the printer using WiFi Protected Setup (WPS).....	125
Set up the printer using the embedded web server (EWS).....	125
Change the connection type.....	126
Test the wireless connection.....	127
Guidelines for ensuring wireless network security.....	127
Overview of security settings.....	127
Add hardware addresses to a wireless router (MAC filtering).....	127
Other wireless security guidelines.....	128
Guidelines for reducing interference on a wireless network	128
Uninstall and reinstall the HP software.....	128
Windows.....	129
Mac OS X.....	129
D Printer management tools	
Toolbox (Windows).....	130
HP Utility (Mac OS X).....	130
Embedded web server.....	130
About cookies.....	131
To open the embedded web server.....	131
Embedded web server features.....	131
Product security features.....	133
Assign an administrator password in the embedded web server.....	133
Control panel lock.....	133
Disable unused protocols and services.....	133
Administrator settings.....	134
Color access control.....	134
Protected protocols – HTTPS.....	134
Firewall.....	134
Syslog.....	134
Certificates.....	134
Signed firmware.....	134
Wireless authentication.....	135
Index.....	142

1 Get started

This guide provides details about how to use the printer and how to resolve problems.

- [Accessibility](#)
- [HP EcoSolutions \(HP and the Environment\)](#)
- [Understand the printer parts](#)
- [Use the printer control panel](#)
- [Select paper](#)
- [Load paper](#)
- [Insert a memory device](#)
- [Install the accessories](#)
- [Maintain the printer](#)
- [Update the printer](#)
- [Open the printer software \(Windows\)](#)
- [Turn the printer off](#)
- [Restore factory defaults](#)

 **NOTE:** If you are using the printer with a computer running Windows XP Starter Edition, Windows Vista Starter Edition, Windows 7 Starter Edition, or Windows 8 Starter Edition, some features might not be available. For more information, see [System requirements](#).

Accessibility

The printer provides a number of features that make it accessible for people with disabilities.

Visual

The HP software provided with the printer is accessible for users with visual impairments or low vision by using your operating system's accessibility options and features. The software also supports most assistive technology such as screen readers, Braille readers, and voice-to-text applications. For users who are color blind, colored buttons and tabs used in the HP software and on the printer control panel have simple text or icon labels that convey the appropriate action.

Mobility

For users with mobility impairments, the HP software functions can be executed through keyboard commands. The HP software also supports Windows accessibility options such as StickyKeys, ToggleKeys, FilterKeys, and MouseKeys. The printer doors, buttons, paper trays, and paper guides can be operated by users with limited strength and reach.

Support

For more details about the accessibility of this printer and HP's commitment to product accessibility, visit HP's website at www.hp.com/accessibility.

For accessibility information for Mac OS X, visit the Apple website at www.apple.com/accessibility.

HP EcoSolutions (HP and the Environment)

HP is committed to helping you optimize your environmental footprint and empowering you to print responsibly—at home or in the office.

For more detailed information about environmental guidelines HP follows during the manufacturing process, see [Environmental product stewardship program](#). For more information about HP's environmental initiatives, visit www.hp.com/ecosolutions.

Manage power

To conserve electricity, try the following:

- Turn on the printer's Sleep Mode feature, and then select the option for the shortest time. After the printer has been inactive for this period of time, the printer will go into low-power mode. To configure this feature, touch **ECO** (eco button) on the printer's control panel display, touch **Sleep**, and then touch the desired option.
- Use the printer's Schedule On and Off feature, and then select the days and time you want the printer to turn on and turn off automatically. For example, you can schedule the printer to turn on at 8am and turn off at 8pm from Monday to Friday. In this way, you will save energy during the night and weekends. To configure this feature, touch **ECO** (eco button) on the printer's control panel display, touch **Schedule On and Off**, and then set the time to turn on and off the printer.
- Adjust the screen brightness to a dimmer setting. To configure this feature, touch **ECO** (eco button) on the printer's control panel display, touch **Screen Brightness**, and then set the desired option.

 **NOTE:** The printer's Sleep Mode and Schedule On and Off features are temporarily not available if one or more of the ink cartridges are missing. After the cartridge is reinstalled, these features resume.

 **CAUTION:** HP recommends that you replace any missing cartridges as soon as possible to avoid print quality issues and possible extra ink usage or damage to the ink system. Never turn off the printer when ink cartridges are missing.

Optimize printing supplies

To optimize printing supplies such as ink and paper, try the following:

- Recycle used original HP ink cartridges through HP Planet Partners. For more information, visit www.hp.com/recycle.
- Optimize paper usage by printing on both sides of the paper. If the printer has an HP automatic two-sided printing accessory (duplexer), see [Print on both sides \(duplexing\)](#).
- Save ink and paper when printing web content with HP Smart Print. For more information, visit www.hp.com/go/smartprint.
- Change the print mode to a draft setting. The draft setting uses less ink.
- Do not clean the printhead unnecessarily. This wastes ink and shortens the life of the cartridges.

Understand the printer parts

This section contains the following topics:

- [Front view](#)
- [Printing supplies area](#)
- [Back view](#)

Front view

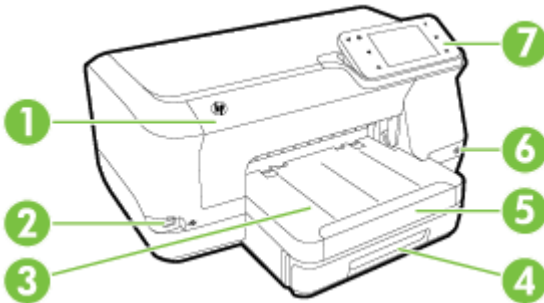

1	Ink cartridge access door
2	Front universal serial bus (USB) port
3	Output tray
4	Tray 1
5	Output tray extension
6	 (Power button)
7	Control panel

Printing supplies area

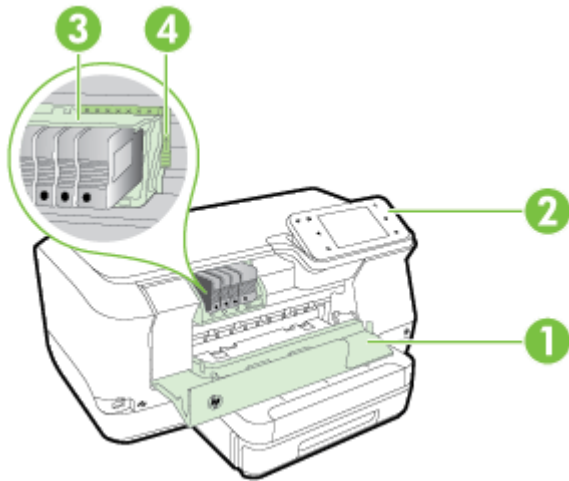

1	Ink cartridge access door
2	Ink cartridges
3	Printhead
4	Printhead latch

Back view

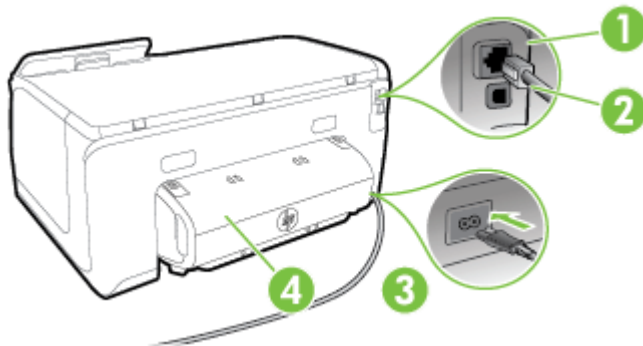

1	Ethernet network port
2	Rear universal serial bus (USB) port
3	Power input
4	Automatic two-sided printing accessory (duplexer)

Use the printer control panel

This section contains the following topics:

- [Overview of buttons and lights](#)
- [Control panel display icons](#)
- [Change printer settings](#)

Overview of buttons and lights

The following diagrams and related tables provide a quick reference to the printer control panel features for each printer model.

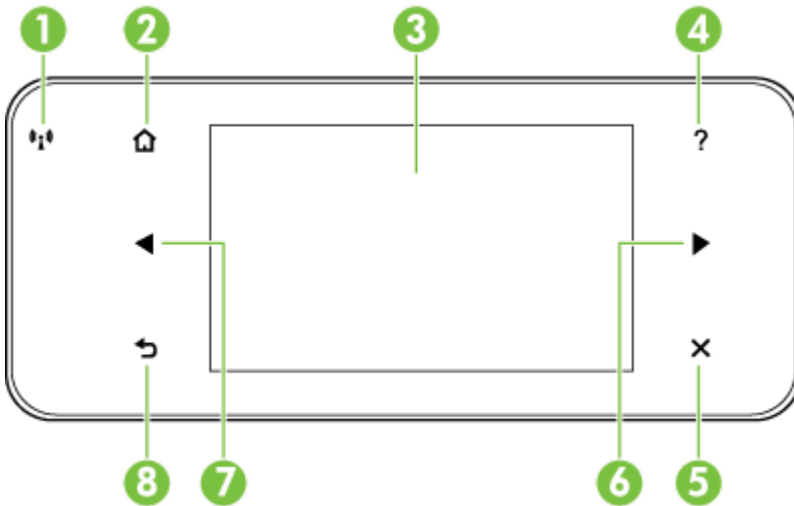





Label	Name and Description
1	Wireless icon: The light next to the icon is lit when the 802.11 wireless feature is on, and the printer is connected to a network. If the light is blinking the wireless feature is on, but the printer is not connected to a network. If the light is off, the wireless feature is turned off.
2	Home button: Returns to the home screen from any other screen.
3	Control panel display: Touch the screen to select menu options. For information about the icons that appear on the display, see Control panel display icons .
4	Help button: Opens the Help menu.
5	Cancel button: Stops a job, exits a menu, or exits settings.
6	Right arrow button: Navigates through settings in the menus.
7	Left arrow button: Navigates through settings in the menus.
8	Back button: Returns to the previous menu.

Control panel display icons

Icon	Purpose
	Shows that an Ethernet network connection exists.
	Shows that a wireless network connection exists, and provides access to the wireless status and settings. The signal strength is indicated by the number of curved lines. This is for infrastructure mode. For more information, see Set up the printer for wireless communication .
	Shows that HP ePrint is turned on. For more information, see HP ePrint .
	Displays a screen where you can use HP Apps. For more information, see Printer Apps .
	Displays a screen where you can adjust photo printing options.
	Displays the Setup screen for generating reports, changing maintenance settings, and accessing the Help screen.

(continued)

Icon	Purpose
	Displays the Network screen for selecting options.
	Provides more information about the printer's features.
	Displays a screen where you can see information about the ink cartridges, including fill levels. This icon has a red border when an ink cartridge needs attention. NOTE: Ink level warnings and indicators provide estimates for planning purposes only. When you receive a low-ink warning message, consider having a replacement cartridge available to avoid possible printing delays. You do not need to replace cartridges until prompted to do so.
	Displays a screen where you can learn about printer features that can help conserve natural resources and reduce the impact of your printing choices. TIP: You can configure settings for some features from this screen.

Change printer settings

Use the control panel to change the printer's mode and settings, print reports, or get help for the printer.

 **TIP:** If the printer is connected to a computer, you can also change the printer settings using HP software tools available on your computer, such as the HP printer software, HP Utility (Mac OS X), or the EWS. For more information about these tools, see [Printer management tools](#).

This section contains the following topics:



- [Select the mode](#)
- [Change printer settings](#)

Select the mode

The main menu of the control panel display shows the available modes for the printer.

 **NOTE:** To select a mode, touch the ◀ (left arrow) or the ▶ (right arrow) to see the available modes, and then touch the icon to select the desired mode. Follow the prompts on the control panel display to complete the job. The control panel display returns to the main menu when the job is finished.

To select a different mode

Touch  (Back button) to return to the main menu. Touch  (left arrow) or  (right arrow) to scroll through the available modes, and then touch the icon to select the desired mode.

To change settings for a mode

1. After selecting a mode, touch the arrow buttons to scroll through the available settings, and then touch the setting you want to change.
2. Follow the prompts on the display to change the settings, and then touch **Done**.

 **NOTE:** Touch  (Back button) to return to the previous menu.

Change printer settings

To change the printer settings or print reports, use the options available in the Setup menu:

1. Touch , and then touch **Setup**.
2. Touch the arrow buttons to scroll through the menus.
3. Touch the menu items to select menus or options.

 **NOTE:** Touch  (Back button) to return to the previous menu.

Select paper

The printer is designed to work well with most types of office media. It is best to test a variety of print media types before buying large quantities. Use HP media for optimum print quality. For more information about HP media, visit the HP website at www.hp.com.



HP recommends plain papers with the ColorLok logo for printing of everyday documents. All papers with the ColorLok logo are independently tested to meet high standards of reliability and print quality, and produce documents with crisp, vivid color, bolder blacks and dry faster than ordinary plain papers. Look for papers with the ColorLok logo in a variety of weights and sizes from major paper manufacturers.

This section contains the following topics:

- [Recommended papers for printing](#)
- [Recommended papers for photo printing](#)
- [Tips for selecting and using paper](#)

Recommended papers for printing

If you want the best print quality, HP recommends using HP papers that are specifically designed for the type of project you are printing.

Depending on your country/region, some of these papers might not be available.

HP Brochure Paper HP Professional Paper	These papers are glossy-coated or matte-coated on both sides for two-sided use. They are the perfect choice for producing professional quality marketing materials such as brochures and mailers, as well as business graphics for report covers and calendars.
HP Premium Presentation Paper HP Professional Paper	These papers are heavy two-sided matte papers perfect for presentation, proposals, reports, and newsletters. They are heavyweight for an impressive look and feel.
HP Bright White Inkjet Paper	HP Bright White Inkjet Paper delivers high-contrast colors and sharp text. It is opaque enough for two-sided color usage with no showthrough, which makes it ideal for newsletters, reports, and flyers. It features ColorLok Technology for less smearing, bolder blacks, and vivid colors.
HP Printing Paper	HP Printing Paper is a high-quality multifunction paper. It produces documents that look and feel more substantial than documents printed on standard multipurpose or copy paper. It features ColorLok Technology for less smearing, bolder blacks, and vivid colors.
HP Office Paper	HP Office Paper is a high-quality multifunction paper. It is suitable for copies, drafts, memos and other everyday documents. It features ColorLok Technology for less smearing, bolder blacks, and vivid colors.
HP Office Recycled Paper	HP Office Recycled Paper is a high-quality multifunction paper made with 30% recycled fiber. It features ColorLok Technology for less smearing, bolder blacks and vivid colors.

To order HP papers and other supplies, go to www.hp.com. Go to **Shop for Products and Services**, and select **Ink, toner and paper**.

 **NOTE:** At this time, some portions of the HP website are available in English only.

Recommended papers for photo printing

For the best print quality, HP recommends using HP papers that are specifically designed for the type of project you are printing. Depending on your country/region, some of these papers might not be available.

Depending on your country/region, some of these papers might not be available.

HP Premium Plus Photo Paper	HP's best photo paper is heavyweight for producing professional quality photos. Features an instant-dry finish for easy handling without smudging. It resists water, smears, fingerprints, and humidity. It is available in several sizes, including A4, 8.5 x 11 inch, 10 x 15 cm (4 x 6 inch), 13 x 18 cm (5 x 7 inch), and two finishes – glossy or soft-gloss (satin matte). It is acid-free for longer lasting documents.
HP Advanced Photo Paper	This thick photo paper features an instant-dry finish for easy handling without smudging. It resists water, smears, fingerprints, and humidity. Your prints have a look and feel comparable to a store processed photo. It is available in several sizes, including A4, 8.5 x 11 inch, 10 x 15 cm (4 x 6 inch), 13x18 cm (5 x 7 inch), and two finishes – glossy or soft gloss (satin matte). It is acid-free for longer lasting documents.
HP Everyday Photo Paper	Print colorful, everyday snapshots at a low cost, using paper designed for casual photo printing. This affordable, photo paper dries quickly for

(continued)

easy handling. Get sharp, crisp images when you use this paper with any inkjet printer. Available in semi-gloss finish in 8.5 x 11 inch, A4, 4 x 6 inch, and 10 x 15 cm. It is acid-free for longer lasting documents.

To order HP papers and other supplies, go to www.hp.com. Go to **Shop for Products and Services** and select **Ink, toner and paper**.

 **NOTE:** At this time, some portions of the HP website are available in English only.

Tips for selecting and using paper

For the best results, observe the following guidelines.

- Always use media that conforms to the printer specifications. For more information, see [Paper specifications](#).
- Load only one type of media at a time into a tray or automatic document feeder (ADF).
- When loading the trays, make sure the media is loaded correctly. For more information, see [Load paper](#).
- Do not overload the tray. For more information, see [Load paper](#).

Load paper

This section provides instructions for loading media into the printer, and contains the following topics:

- [Load standard-size paper](#)
- [Load envelopes](#)
- [Load cards and photo paper](#)
- [Load custom-size paper](#)

Load standard-size paper

Use these instructions to load standard paper.

1. Pull out Tray 1.

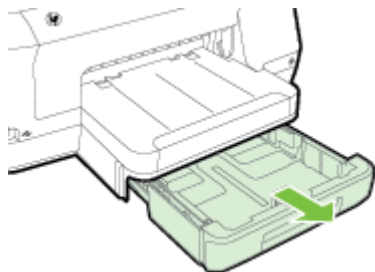

2. Insert the media print-side down in the center of the tray. Make sure the stack of media aligns with the line on the width guide, and is not higher than the paper stack line on the guide.

 **NOTE:** Do not load paper while the printer is printing.

3. Slide the paper guides in the tray to adjust them for the media size that you have loaded, and then reinsert the tray.

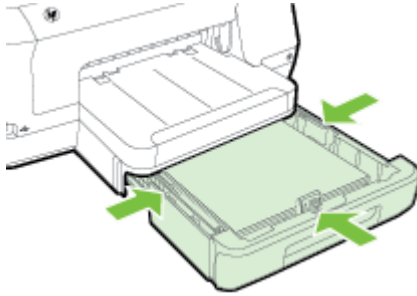

 **NOTE:** To load legal-size paper, press the blue latch at the bottom left of the input tray and fully extend the tray.

4. Pull out the extension on the output tray.

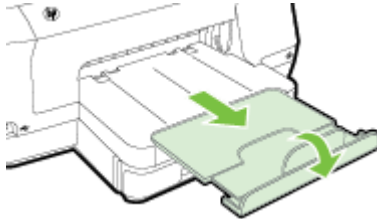

Load envelopes

Use these instructions to load an envelope.

1. Pull out Tray 1.

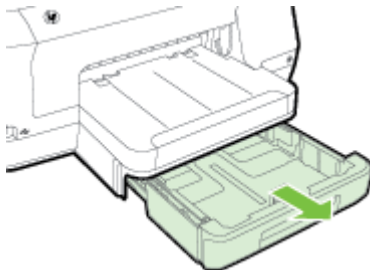

2. Insert the envelopes print-side down and load according to the graphic. Make sure the stack of envelopes does not exceed the line marking in the tray.

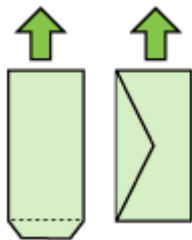

 **NOTE:** Do not load paper while the printer is printing.

3. Slide the paper guides in the tray to adjust them for the media size that you have loaded, and then reinsert the tray.
4. Pull out the extension on the output tray.

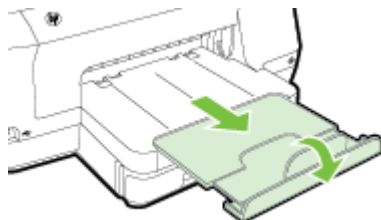

Load cards and photo paper

Use these instructions to load cards or photo paper.

1. Pull out Tray 1.

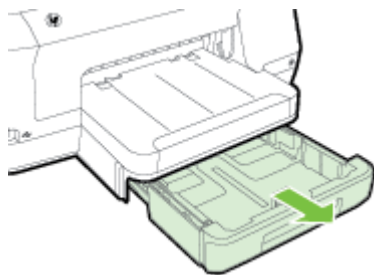

2. Insert the media print-side down in the center of the tray. Make sure the stack of media aligns with the line on the width guide, and is not higher than the paper stack line on the guide.

 **NOTE:** Do not load paper while the printer is printing.

3. Slide the paper guides in the tray to adjust them for the media size that you have loaded, and then reinsert the tray.
4. Pull out the extension on the output tray.

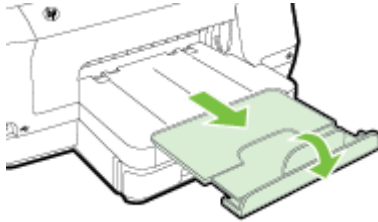

Load custom-size paper

Use these instructions to load custom-size paper.

 **CAUTION:** Use only custom-size paper that is supported by the printer. For more information, see [Paper specifications](#).

 **NOTE:** Load only plain paper in Tray 2.

1. Pull out Tray 1.

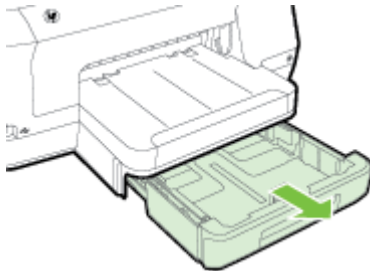

2. Insert the media print-side down in the center of the tray. Make sure the stack of media aligns with the line on the width guide, and is not higher than the paper stack line on the guide.

 **NOTE:** Do not load paper while the printer is printing.

3. Slide the paper guides in the tray to adjust them for the media size that you have loaded, and then reinsert the tray.

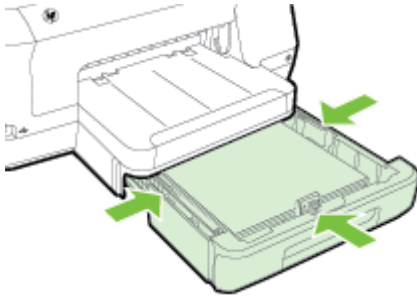

4. Pull out the extension on the output tray.



Insert a memory device

If your digital camera uses a memory card to store photos, you can connect the camera to the printer to print your photos.

CAUTION: Attempting to remove a memory card while it is being accessed can damage files on the card. You can safely remove a card only when the photo light is not blinking. Also, never insert more than one memory card at a time as this can also damage files on the memory cards.

NOTE: The printer does not support encrypted memory cards.

For more information on the supported memory cards, see [Memory device specifications](#).

To connect a storage device

1. If you are connecting a digital camera, change the USB mode of the camera to storage mode, and then connect one end of the USB cable to the camera.

 **NOTE:** Different cameras use different terms to describe the storage mode. For instance, some cameras have a digital camera setting and a disk drive setting. In this instance, the disk drive setting is the storage mode setting. If storage mode does not work on your camera, you might need to upgrade the camera firmware. For more information, see the documentation that came with the camera.

2. Insert the USB storage device or the other end of the camera's USB cable to the USB port on the front of the printer.

 **NOTE:** If your USB device does not fit into this port due to size limitations, or if the connector on the device is shorter than 11 mm (0.43 in), you will need to purchase a USB extension cable in order to use your device with this port. For more information on supported USB devices, see [Memory card specifications](#).

Install the accessories

This section contains the following topics:

- [Install the automatic two-sided printing accessory \(duplexer\)](#)
- [Install Tray 2](#)
- [Configure trays](#)
- [Turn on accessories in the printer driver](#)

Install the automatic two-sided printing accessory (duplexer)

You can print on both sides of a sheet of paper automatically. For information on using the duplexer, see [Print on both sides \(duplexing\)](#).

To install the duplexer:

Slide the duplexer into the back of the printer until the unit locks into place. Do not press the buttons on either side of the duplexer when installing the unit; use them only for removing the unit from the printer.

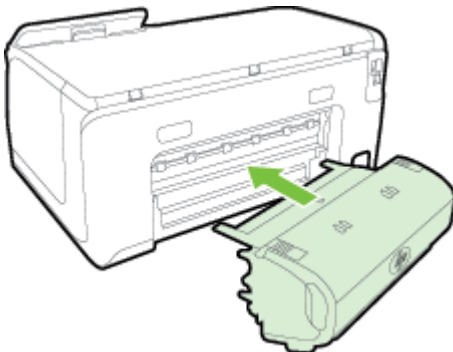

Install Tray 2

Tray 2 can hold up to 250 sheets of plain paper. For ordering information, see [HP supplies and accessories](#).

To install Tray 2

1. Unpack the tray, remove the packing tapes and materials, and move the tray to the prepared location. The surface must be sturdy and level.
2. Turn off the printer, and disconnect the power cord.
3. Set the printer on top of the tray.

CAUTION: Be careful to keep your fingers and hands clear of the bottom of the printer.

4. Connect the power cord and turn on the printer.
5. Enable Tray 2 in the printer driver. For more information, see [Turn on accessories in the printer driver](#).

To load Tray 2

1. Pull the tray out of the printer by grasping under the front of the tray.

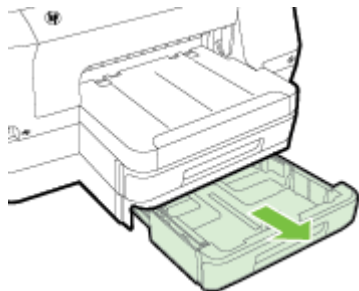

2. Insert the paper print-side down in the center of the tray. Make sure the stack of paper aligns with the line on the width guide, and does not exceed the line marking on the guide.

NOTE: Tray 2 can be loaded only with plain paper.

3. Slide the paper guides in the tray to adjust them for the size that you have loaded.

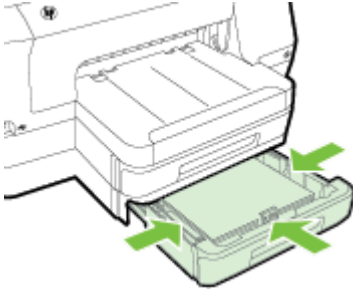

4. Gently reinsert the tray.
5. Pull out the extension on the output tray.

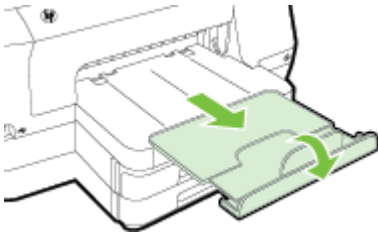

Configure trays

 **NOTE:** Tray 2 is an optional accessory. For ordering information, see [Order printing supplies online](#).

To configure the trays, you must have Tray 2 installed and turned on.

By default, the printer draws media from Tray 1. If Tray 1 is empty, the printer draws media from Tray 2 (if it is installed and loaded with media). You can change this default behavior by using the following features:

- **Tray Lock:** Use this feature to protect special media such as letterhead or preprinted media from accidental use. If the printer runs out of media while printing a document, it will not use media from a locked tray to complete the print job.
- **Default Tray:** Use this feature to determine the first tray from which the printer draws media.

 **NOTE:** To use the tray lock and default tray settings, you must select the automatic tray selection option in the printer software. Also, if the printer is on a network and you set a default tray, the setting will affect all users of the printer.

Tray 2 is designed to hold only plain paper.

The following table lists possible ways you can use the tray settings to meet your printing needs.

I want to...	Follow these steps
Load both trays with the same media, and have the printer pick media from one tray if the other one is empty.	<ul style="list-style-type: none"> • Load media in Tray 1 and Tray 2. For more information, see Load paper. • Make sure tray lock is disabled.
Have both special media (such as transparencies or letterhead) and plain paper loaded in the trays.	<ul style="list-style-type: none"> • Load special media in Tray 1 and plain paper in Tray 2. • Make sure the default tray is set to Tray 2. • Make sure tray lock is set to Tray 1.
Load media in both trays but have the printer pick media from a specific tray first.	<ul style="list-style-type: none"> • Load media in Tray 1 and Tray 2. • Make sure default tray is set to the appropriate tray.

To configure the trays

1. Make sure the printer is turned on.
2. Touch  (right arrow), touch **Setup**, touch **Preferences**, and then select **Default Tray** or **Tray Lock**.
3. Click **OK** or **Apply** after changing the desired tray settings.

Turn on accessories in the printer driver

- [To turn on accessories \(Windows\)](#)
- [To turn on accessories \(Mac OS X\)](#)

To turn on accessories (Windows)

1. Click **Start**, and then click **Printers** or **Printers and Faxes** or **Devices and Printers**.
- Or -
Click **Start**, click **Control Panel**, and then double-click **Printers**.
2. Right-click the printer icon, and then click **Properties**.
3. Select the **Device Settings** tab. Click the accessory that you want to turn on, click **Installed** from the drop-down menu, and then click **OK**.

To turn on accessories (Mac OS X)

Mac OS X automatically turns on all accessories in the printer driver when you install the printer software. If you add a new accessory later, follow these steps:



1. Open the **System Preferences** and then select **Print & Fax** or **Print & Scan**.
2. Select the printer from list of printers, and then click **Options & Supplies**.
3. Click the **Driver** tab.
4. Select the options you want to install, and then click **OK**.

Maintain the printer

This section provides instructions for keeping the printer in top working condition. Perform these maintenance procedures as necessary.

- [Clean the exterior](#)

Clean the exterior

 **WARNING!** Before cleaning the printer, turn the printer off by pressing the  (Power button) and unplug the power cord from the electrical socket.

Use a soft, damp, lint-free cloth to wipe dust, smudges, and stains off of the case. Keep fluids away from the interior of the printer, as well as from the printer control panel.

Update the printer

HP is always working to improve the performance of its printers and bring you the latest features. If the printer is connected to a network and Web Services has been enabled, you can check for and install printer updates.

To update the printer, use one of the following methods:

- [Update the printer using the embedded web server](#)
- [Update the printer using the printer control panel](#)

Update the printer using the embedded web server

1. Open the EWS. For more information, see [Embedded web server](#).
2. Click the **Web Services** tab.
3. In the **Web Services Settings** section, click **Product Update**, click **Check Now**, and follow the on-screen instructions.
4. If the product update option is not available, follow these instructions:
 - a. In the **Web Services Settings** section, click **Setup**, click **Continue**, and follow the on-screen instructions.
 - b. If prompted, choose to allow the printer to check for and install printer updates.

 **NOTE:** If a printer update is available, the printer downloads and installs the update, and then restarts.

NOTE: If prompted for proxy settings and if your network uses proxy settings, follow the on-screen instructions to set up a proxy server. If you do not have the details, contact your network administrator or the person who set up the network.

Update the printer using the printer control panel

1. On the printer control panel, touch  (HP ePrint), touch **Settings**, and then touch **Printer Update**.
2. Touch **Check for Update Now**, and then follow the on-screen instructions.

To enable the printer to automatically check for updates:

1. Touch **Settings**, and then touch **Printer Update**.
2. Touch **Auto Update**, and then touch **On**.

Open the printer software (Windows)

- **Windows XP, Windows Vista, and Windows 7:** From the computer desktop, click **Start**, select **Programs** or **All Programs**, click **HP**, click the folder for your printer, and then select the icon with your printer's name.
- **Windows 8:** On the **Start** screen, do one of the following.
 - Right-click the **Start** screen, click **All Apps** on the **App** bar, and then click the icon with your printer's name.
 - Click **Desktop**, and then click the icon with your printer's name.
 - Click the icon with your printer's name.

Turn the printer off

Turn the printer off by pressing the  (Power button) located on the printer. Wait until the power light turns off before unplugging the power cord or turning off a power strip.

CAUTION: If you incorrectly turn the printer off, the print carriage might not return to the correct position causing problems with the ink cartridges and print quality issues.

CAUTION: HP recommends that you replace any missing cartridges as soon as possible to avoid print quality issues and possible extra ink usage or damage to the ink system. Never turn off the printer when ink cartridges are missing.

Restore factory defaults





To restore the the printer to factory defaults, complete the following steps:

1. Touch , and then touch **Setup**.
2. Touch **Tools**.
3. Touch **Restore Factory Defaults**.

2 Print

Most print settings are automatically handled by the software application. Change the settings manually only when you want to change print quality, print on specific types of paper, or use special features. For more information about selecting the best print media for your documents, see [Select paper](#).

Choose a print job to continue:

	Print documents
	Print brochures
	Print on envelopes
	Print photos
	Print on special and custom-size paper

Print documents

Follow the instructions for your operating system.

- [Print documents \(Windows\)](#)
- [Print documents \(Mac OS X\)](#)

 **NOTE:** This printer includes HP ePrint, a free service from HP that allows you to print documents on your HP ePrint-enabled printer anytime, from any location, and without any additional software or printer drivers. For more information, see [HP ePrint](#).

Print documents (Windows)

1. Load paper in the tray. For more information, see [Load paper](#).
2. On the **File** menu in your software application, click **Print**.
3. Make sure the printer you want to use is selected.

4. To change settings, click the button that opens the **Properties** dialog box. Depending on your software application, this button might be called **Properties**, **Options**, **Printer Setup**, **Printer**, or **Preferences**.
5. Change the paper orientation on the **Finishing** tab, and paper source, paper type, paper size, and quality settings on the **Paper/Quality** tab. To print in black and white, click the **Color** tab, and then select the **Print in Grayscale** option.
6. Click **OK**.
7. Click **Print** or **OK** to begin printing.

Print documents (Mac OS X)

1. Load paper in the tray. For more information, see [Load paper](#).
2. Depending on your application use one of the following procedures to select a paper size:

From Page Setup

- a. From the **File** menu in your software application, click **Page Setup**.



NOTE: If you do not see a **Page Setup** menu item, go to step 3.

- b. Make sure the printer you want to use is selected in the **Format For** pop-up menu.
- c. Select the paper size from the **Paper Size** pop-up menu, and then click **OK**.

-OR-

From Print

- a. From the **File** menu in your software application, click **Print**.
- b. Make sure the printer you want to use is selected.
- c. Select the paper size from the **Paper Size** pop-up menu (if available).
3. On the Print dialog change the print settings for the option provided in the pop-up menus, as appropriate for your project.



NOTE: If you do not see any options, click the disclosure triangle next to the **Printer** pop-up menu or click **Show Details**.

4. Click **Print** to begin printing.

Print brochures

Follow the instructions for your operating system, including edge-to-edge brochures.

- [Print brochures \(Windows\)](#)
- [Print brochures \(Mac OS X\)](#)



NOTE: This printer includes HP ePrint, a free service from HP that allows you to print documents on your HP ePrint-enabled printer anytime, from any location, and without any additional software or printer drivers. For more information, see [HP ePrint](#).

Print brochures (Windows)

 **NOTE:** To set print settings for all print jobs, make the changes in the HP software provided with the printer. For more information on the HP software, see [Printer management tools](#).

1. Load paper in the tray. For more information, see [Load paper](#).
2. On the **File** menu in your software application, click **Print**.
3. Make sure the printer you want to use is selected.
4. To change settings, click the button that opens the **Properties** dialog box. Depending on your software application, this button might be called **Properties**, **Options**, **Printer Setup**, **Printer**, or **Preferences**.
5. Change the paper orientation on the **Finishing** tab, and paper source, paper type, paper size, and quality settings on the **Paper/Quality** tab.
 - ▲ To print in black and white, click the **Color** tab, and then select the **Print in Grayscale** option.
 - ▲ To print an edge-to-edge brochure select one of the Edge-to-Edge paper sizes, and from the **Paper type** drop-down box, select one of the supported brochure papers.
6. Click **OK**.
7. Click **Print** or **OK** to begin printing.

Print brochures (Mac OS X)

1. Load paper in the tray. For more information, see [Load paper](#).
2. Depending on your application use one of the following procedures to select a paper size:

From Page Setup

- a. From the **File** menu in your software application, click **Page Setup**.

 **NOTE:** If you do not see a **Page Setup** menu item, go to step 3.

- b. Make sure the printer you want to use is selected in the **Format For** pop-up menu.
 - c. Select the paper size from the **Paper Size** pop-up menu, and then click **OK**.
- OR-

From Print

- a. From the **File** menu in your software application, click **Print**.
 - b. Make sure the printer you want to use is selected.
 - c. Select the paper size from the **Paper Size** pop-up menu (if available).
3. From the **File** menu in your software application, click **Print**.

4. On the Print dialog click **Color/Quality Option** from the pop-up menu, and then select the following settings:
 - **Media Type:** The appropriate brochure paper type
 - **Print Quality:** **Draft**, **Normal**, or **Best**

 **NOTE:** If you do not see these options, click the disclosure triangle next to the **Printer** pop-up menu or click **Show Details**.

5. Select any other print settings that you want, and then click **Print** to begin printing.

Print on envelopes

Avoid envelopes with the following characteristics:

- Very slick finish
- Self-stick adhesives, clasps, or windows
- Thick, irregular, or curled edges
- Areas that are wrinkled, torn, or otherwise damaged

Make sure the folds of envelopes you load in the printer are sharply creased.

 **NOTE:** For more information about printing on envelopes, see the documentation available with the software program you are using.

Follow the instructions for your operating system.

- [Print on envelopes \(Windows\)](#)
- [Print on envelopes \(Mac OS X\)](#)

Print on envelopes (Windows)

1. Load envelopes print-side down in the tray. For more information, see [Load paper](#).
2. On the **File** menu in your software application, click **Print**.
3. Make sure the printer you want to use is selected.
4. To change settings, click the button that opens the **Properties** dialog box. Depending on your software application, this button might be called **Properties**, **Options**, **Printer Setup**, **Printer**, or **Preferences**.
5. On the **Layout** tab, change the orientation to **Landscape**.
6. Click **Paper/Quality**, and then select the appropriate envelope type from the **Paper Size** drop-down list.

 **TIP:** You can change more options for the print job by using the features available on the other tabs in the dialog box.

7. Click **OK**, and then click **Print** or **OK** to begin printing.

Print on envelopes (Mac OS X)

1. Load envelopes in the tray. For more information, see [Load paper](#).
2. Depending on your application use one of the following procedures to select a paper size:

From Page Setup

- a. From the **File** menu in your software application, click **Page Setup**.



NOTE: If you do not see a **Page Setup** menu item, go to step 3.

- b. Make sure the printer you want to use is selected in the **Format For** pop-up menu.
- c. Select the paper size from the **Paper Size** pop-up menu, and then click **OK**.

-OR-

From Print

- a. From the **File** menu in your software application, click **Print**.
 - b. Make sure the printer you want to use is selected.
 - c. Select the appropriate envelope size in the **Paper Size** pop-up menu (if available).
3. On the Print dialog select the **Orientation** option.



NOTE: If you do not see these options, click the disclosure triangle next to the **Printer** pop-up menu or click **Show Details**.

4. Select any other print settings that you want, and then click **Print** to begin printing.

Print photos

Do not leave unused photo paper in the input tray. The paper might start to curl, which could impair the quality of your printout. Photo paper should be flat before printing.

Follow the instructions for your operating system.

- [Print photos on photo paper \(Windows\)](#)
- [Print photos on photo paper \(Mac OS X\)](#)
- [Print photos from a memory device](#)



NOTE: This printer includes HP ePrint, a free service from HP that allows you to print documents on your HP ePrint-enabled printer anytime, from any location, and without any additional software or printer drivers. For more information, see [HP ePrint](#).

Print photos on photo paper (Windows)

1. Load paper in the tray. For more information, see [Load paper](#).
2. On the **File** menu in your software application, click **Print**.
3. Make sure the printer you want to use is selected.
4. To change settings, click the option that opens the printer **Properties** dialog box. Depending on your software application, this option might be called **Properties**, **Options**, **Printer Setup**, **Printer**, or **Preferences**.

5. On the **Paper/Quality** tab, select the appropriate photo paper type from the **Paper type** drop-down menu.
6. On the **Paper/Quality** tab, select **Best** from the **Print Quality** drop-down menu.
7. To print in black and white, click the **Color** tab, and then select the **Print in Grayscale** option.
8. Click **OK**, and then click **Print** or **OK** to begin printing.

Print photos on photo paper (Mac OS X)

1. Load paper in the tray. For more information, see [Load paper](#).
2. Depending on your application use one of the following procedures to select a paper size:

From Page Setup

- a. From the **File** menu in your software application, click **Page Setup**.

 **NOTE:** If you do not see a **Page Setup** menu item, go to step 3.

- b. Make sure the printer you want to use is selected in the **Format For** pop-up menu.
- c. Select the paper size from the **Paper Size** pop-up menu, and then click **OK**.

-OR-

From Print

- a. From the **File** menu in your software application, click **Print**.
- b. Make sure the printer you want to use is selected.
- c. Select the paper size from the **Paper Size** pop-up menu (if available).
3. On the Print dialog click **Color/Quality Option** from the pop-up menu, and then select the following settings:

- **Media Type:** The appropriate photo paper type
- **Print Quality:** **Draft**, **Normal**, or **Best**

 **NOTE:** If you do not see these options, click the disclosure triangle next to the **Printer** pop-up menu or click **Show Details**.

4. To print the photo in black and white, click **Grayscale** from the **Print Color as Gray** pop-up menu, and then select one of the following options:
 - **Off:** Turns printing in grayscale off.
 - **Black Ink Only:** Uses black ink to print your photo in grayscale. The gray shading is created by varying patterns of black dots, which might result in a grainy image.
 - **High Ink Only:** Uses all the available colors to print your photo in grayscale. This creates smooth and natural shades of gray.
5. Select any other print settings that you want, and then click **Print** to begin printing.

Print photos from a memory device

You can connect a USB storage device (such as a keychain drive) to the USB port on the front of the printer.

For more information about using memory devices, see [Insert a memory device](#).

 **CAUTION:** Attempting to remove a memory device while it is being accessed can damage files on the memory device. You can safely remove a memory card only when the status light is not blinking.

To print selected photos

 **NOTE:** This function is only available if the memory device does not contain Digital Print Order Format (DPOF) content.

1. Connect your memory device to the USB port on the front of the printer. The **Select Option** screen appears on the control panel display.
2. Touch **Photo**. The **Photo Menu** screen appears.
3. Touch **View & Print**. The photos are displayed.
4. Follow the instructions on the control panel display to select, edit, or print the photos.

Print on special and custom-size paper

If your application supports custom-size paper, set the size in the application before printing the document. If not, set the size in the printer driver. You might need to reformat existing documents to print them correctly on custom-size paper.

Use only custom-size paper that is supported by the printer. For more information, see [Paper specifications](#).

 **NOTE:** Defining custom-size paper sizes is only available in the HP printing software in Mac OS X.

Follow the instructions for your operating system.

- [Print on special or custom-size paper \(Windows\)](#)
- [Print on special or custom-size paper \(Mac OS X\)](#)
- [Set up custom sizes \(Mac OS X\)](#)

Print on special or custom-size paper (Windows)

1. Load the appropriate paper in the tray. For more information, see [Load paper](#).
2. On the **File** menu in your software application, click **Print**.
3. Make sure the printer you want to use is selected.
4. To change settings, click the button that opens the **Properties** dialog box. Depending on your software application, this button might be called **Properties**, **Options**, **Printer Setup**, **Printer**, or **Preferences**.
5. On the **Paper/Quality** tab, click the **Custom...** button.
6. Name the custom size and define the size of the paper on the **Custom Paper Size** screen.

 **NOTE:** The custom paper size you just defined will not be available until you exit, and re-enter the Printing Preferences/Properties.

7. Click the **Paper/Quality** tab, and select the custom paper size from the **Paper sizes:** drop-down box.
8. Click **OK**.
9. Click **Print** or **OK** to begin printing.

Print on special or custom-size paper (Mac OS X)

 **NOTE:** Before you can print on custom-size paper, you must set up the custom size in the HP software provided with the printer. For instructions, see [Set up custom sizes \(Mac OS X\)](#).

1. Load the appropriate paper in the tray. For more information, see [Load paper](#).
2. Depending on your application use one of the following procedures to select a paper size:

From Page Setup

- a. From the **File** menu in your software application, click **Page Setup**.

 **NOTE:** If you do not see a **Page Setup** menu item, go to step 3.

- b. Make sure the printer you want to use is selected in the **Format For** pop-up menu.
 - c. Select the paper size from the **Paper Size** pop-up menu, and then click **OK**.
- OR-

From Print

- a. From the **File** menu in your software application, click **Print**.
- b. Make sure the printer you want to use is selected.
- c. Select the paper size from the **Paper Size** pop-up menu (if available).
3. Click **Paper Handling** from the pop-up menu.
4. Above **Destination Paper Size**, click **Scale to fit paper size**, and then select the custom size.
5. Select any other print settings that you want, and then click **Print** to begin printing.

Set up custom sizes (Mac OS X)

1. Load paper in the tray. For more information, see [Load paper](#).
2. From the **File** menu in your software application, click **Page Setup**, and then make sure the printer you want to use is selected in the **Format For** pop-up menu.

- OR -

From the **File** menu in your software application, click **Print**, and then make sure the printer you want to use is selected.

3. Select **Manage Custom Sizes** in the **Paper Size** pop-up menu.

 **NOTE:** If you do not see these options in the **Print** dialog, click the disclosure triangle next to the **Printer** pop-up menu or click **Show Details**.

4. Click the **+** on the left side of the screen, double-click **Untitled**, and type a name for the new, custom size.

5. In the **Width** and **Height** boxes, type the dimensions, and then set the margins, if you want to customize them.
6. Click **OK**.

HP ePrint

With HP ePrint, you can print from email connected mobile phones, netbooks, other mobile devices, or traditional desktop email clients—anywhere, anytime. Using your mobile device service and the printer's Web Services, you can print documents to a printer that could be sitting next to you or sitting thousands of miles away.

To use the HP ePrint service, you need to have the following components:

- An HP ePrint-enabled printer that is connected to the Internet (either using an Ethernet cable or wireless connection)
- A device that has a functioning email capability

Follow the instructions on the printer's control panel to enable and set up the printer's Web Services. For more information, see www.hpconnected.com.

HP Wireless Direct

With HP wireless direct printing, you can print wirelessly from a computer, smart phone, tablet, or other wireless-capable device—without connecting to an existing wireless network.

When using HP wireless direct printing, note the following guidelines:

- Make sure your computer or mobile device has the necessary software:
If you are using a computer, make sure you have installed the HP printer software provided with the printer.
- If you are using a mobile device, make sure you have installed a compatible printing app. For more information about mobile printing, visit www.hp.com/global/us/en/eprint/mobile_printing_apps.html.
- Make sure HP wireless direct printing is turned on in the printer and, if necessary, security is enabled. For more information, see [Turn on HP wireless direct printing](#).
- Up to five computers and mobile devices can use the same HP wireless direct printing connection.
- HP wireless direct printing can be used while the printer is also connected to a computer using USB cable or to a network (using a wireless or Ethernet connection).
- HP wireless direct printing cannot be used to connect a computer, mobile device, or printer to the Internet.



[Click here to go online for more information.](#)

For more information about wireless printing, see [Set up the printer for wireless communication](#).

 **NOTE:** At this time, these websites might not be available in all languages.

This section contains the following topics:

- [Turn on HP wireless direct printing](#)
- [Print from a wireless-capable mobile device](#)
- [Print from a wireless-capable computer](#)

Turn on HP wireless direct printing

1. From the printer control panel, touch  (Wireless), and then touch **Settings**.
2. Touch **Wireless Direct**, and then touch **On**.

 **TIP:** If you would like to use HP wireless direct printing with greater security and if the computer or mobile device supports WPA2 encryption, select the option that will enable security. With security enabled, only users with the password can connect wirelessly to the printer. Without enabling security, anyone with a wireless device within the wireless range of the printer can connect to the printer.

3. Touch **Wireless Direct Name** to display the wireless direct name.
4. If you have enabled security, touch **Security Passcode** to display the wireless direct password.

 **TIP:** You can also turn on HP wireless direct printing from the embedded web server (EWS). For more information about using the EWS, see [Embedded web server](#).

Print from a wireless-capable mobile device

Make sure you have installed a compatible printing app on your mobile device. For more information, visit www.hp.com/global/us/en/eprint/mobile_printing_apps.html.

1. Make sure you have turned on HP wireless direct printing on the printer. For more information, see [Turn on HP wireless direct printing](#).
2. Turn on the wireless connection in your mobile device. For more information, see the documentation provided with the mobile device.
3. From the mobile device, search for and connect to the HP wireless direct printing name, such as **HP-Setup-XX-Officejet Pro 251dw** (where ** are the unique characters to identify your printer).

If HP wireless direct is turned on with security, enter the password when prompted.

4. From your mobile device's print app, confirm your HP printer is the default printer, and then print your document.

Print from a wireless-capable computer

Follow the instructions for your operating system.

- [Print from a wireless-capable computer \(Windows\)](#)
- [Print from a wireless-capable computer \(Mac OS X\)](#)

Print from a wireless-capable computer (Windows)

1. Make sure you have turned on HP wireless direct printing on the printer. For more information, see [Turn on HP wireless direct printing](#).
2. Turn on the wireless connection in your computer. For more information, see the documentation provided with the computer.
3. From the computer, click the wireless icon on your task tray, select the HP wireless direct printing name, such as **HP-Setup-XX-Officejet Pro 251dw** (where ** are the unique characters to identify your printer).
If HP wireless direct is turned on with security, enter the password when prompted.
4. If the printer has been installed and connected to your computer with a USB cable, enable HP wireless direct printing in the HP printer software. Proceed to step 5 if the printer has been installed and connected to the computer over a network (Ethernet or wireless).
 - a. From the computer desktop, click **Start**, select **Programs** or **All Programs**, click **HP**, click the folder for the printer, and then select **Printer Setup & Software**.
- Or -
On the **Start** screen, right-click an empty area on the screen, click **All Apps** on the app bar, and then click the icon with the printer's name.
 - b. Select **Connect New Printer**.
 - c. When the **Connection Options** software screen appears, select **Wireless**.
Select the printer from the list of detected printers, such as **HP-Setup-XX-Officejet Pro 251dw** (where ** are the unique characters to identify your printer).
 - d. Follow the on-screen instructions.
5. Print your document.

Print from a wireless-capable computer (Mac OS X)

1. Make sure you have turned on HP wireless direct printing on the printer. For more information, see [Turn on HP wireless direct printing](#).
2. Turn on AirPort. For more information, see the documentation provided by Apple.
3. Click the AirPort icon and select the HP wireless direct printing name, such as **HP-Setup-XX-Officejet Pro 251dw** (where ** are the unique characters to identify your printer).
If HP wireless direct is turned on with security, enter the password when prompted.
4. Add the printer.
 - a. In **System Preferences**, select **Print & Fax** or **Print & Scan**, depending on your operating system.
 - b. Click + below the list of printers at the left.
 - c. Select the printer from the list of detected printers (the word "Bonjour" is listed the right column beside the printer name), and click **Add**.
5. Print your document.

Print on both sides (duplexing)

You can print on both sides of a sheet of media automatically by using the automatic two-sided printing accessory (duplexer).

 **NOTE:** Two-sided printing requires an automatic two-sided printing accessory (duplexer) to be installed on the printer.

To print on both sides (Windows)

1. Load the appropriate media. For more information, see [Guidelines for printing on both sides of a page](#) and [Load paper](#).
2. Make sure the duplexer is installed correctly. For more information, see [Install the automatic two-sided printing accessory \(duplexer\)](#).
3. With a document open, click **Print** on the **File** menu, and then select **Print on both sides** options on the **Finishing** tab. Select **Flip pages up** if desired.
4. Change any other settings, and then click **OK**.
5. Print your document.

To print on both sides (Mac OS X)

1. Load the appropriate media. For more information, see [Guidelines for printing on both sides of a page](#) and [Load paper](#).
2. Make sure the duplexer is installed correctly. For more information, see [Install the automatic two-sided printing accessory \(duplexer\)](#).
3. Depending on your application use one of the following procedures to select a paper size:

From Page Setup

- a. From the **File** menu in your software application, click **Page Setup**.

 **NOTE:** If you do not see a **Page Setup** menu item, go to step 3.

- b. Make sure the printer you want to use is selected in the **Format For** pop-up menu.
 - c. Select the paper size from the **Paper Size** pop-up menu, and then click **OK**.
- OR-

From Print

- a. From the **File** menu in your software application, click **Print**.
 - b. Make sure the printer you want to use is selected.
4. On the Print dialog select the paper size from the **Paper Size** pop-up menu (if available).

 **NOTE:** You might need to select the paper-size option labeled **Two-Sided margins**.

5. Check the **Two-Sided** checkbox, and then click the appropriate binding options for the document.
- OR -
Click the **Layout** pop-up menu, and then select the appropriate binding options for the document from the **Two-Sided** pop-up menu.
-
-  **NOTE:** If you do not see any options, click the disclosure triangle next to the **Printer** pop-up menu or click **Show Details**.
-
6. Select any other print settings that you want, and then click **Print**.

View Print Resolutions

1. In printer driver, click the **Paper/Quality** tab, and then click the **Advanced** button.
2. Click the **Resolution** button to view the print resolution.

3 Web Services

The printer offers innovative, web-enabled solutions that can help you quickly access the Internet, obtain documents, and print them faster—and all without using a computer.

 **NOTE:** To use these web features, the printer must be connected to the Internet (either using an Ethernet cable or wireless connection). You cannot use these web features if the printer is connected using a USB cable.

This section contains the following topics:

- [What are Web Services?](#)
- [Set up Web Services](#)
- [Use Web Services](#)
- [Remove Web Services](#)

What are Web Services?

The printer includes the following Web Services:

- [HP ePrint](#)
- [Printer Apps](#)

HP ePrint

HP ePrint is a free service from HP that allows you to print to your HP ePrint-enabled printer anytime, from any location. It's as simple as sending an email to the email address assigned to your printer when you enable Web Services on the printer. No special drivers or software are needed. If you can send an email, you can print from anywhere, using HP ePrint.

Once you have signed up for an account on HP Connected, you can:

- Sign in to view your HP ePrint job status
- Manage your HP ePrint printer queue
- Control who can use your printer's HP ePrint email address to print
- Get help for HP ePrint

Printer Apps

Printer Apps allow you to easily locate and print preformatted web content, directly from your printer.

Printer Apps provide a wide range of content, from store coupons to family activities, news, travel, sports, cooking, photos, and many more. You can even view and print your online images from popular photo sites.

Certain Printer Apps also allow you to schedule the delivery of app content to your printer.

Preformatted content designed specifically for your printer means no cut-off text and pictures, and no extra pages with only one line of text. On some printers, you can also choose paper and print quality settings on the print preview screen.

Set up Web Services

To set up Web Services, complete the following steps.

 **NOTE:** Before you set up Web Services, make sure you are connected to the Internet.

- [Set up Web Services using the HP printer software](#)
- [Set up Web Services using the printer's control panel](#)
- [Set up Web Services using the embedded web server](#)

Set up Web Services using the HP printer software

In addition to enabling key printer features, you can use the HP printer software that came with your printer to set up Web Services. If you didn't set up Web Services when you installed the HP software on your computer, you can still use the software to set up Web Services.

To set up Web Services, complete the following steps for your operating system:

Set up Web Services (Windows)

1. From the computer desktop, click **Start**, select **Programs** or **All Programs**, click **HP**, click the folder for your printer, and then select the icon with your printer's name.
2. Double-click on the **Printer Home Page** under the **Print** section in the **Print** tab. The printer's embedded web server opens.
3. On the **Web Services** tab, click **Setup** in the **Web Services Settings** section.
4. Click **Accept Terms of Use and Enable Web Services**, and then click **Next**.
5. Click **Yes** to allow the printer to automatically check for and install product updates.
6. If your network uses proxy settings when connecting to the Internet, enter these settings.
7. Follow the instructions on the Web Services information sheet to finish the setup.



Set up Web Services (Mac OS X)

- ▲ To set up and manage Web Services in Mac OS X, you can use the printer's embedded web server (EWS). For more information, see [Set up Web Services using the embedded web server](#).

Set up Web Services using the printer's control panel

The printer's control panel provides an easy way to set up and manage Web Services.

To set up Web Services, complete the following steps:

1. Make sure the printer is connected to the Internet.
2. On the printer control panel, touch  (Apps) or  (HP ePrint).
3. Touch **Accept** to accept the Web Services terms of use and enable Web Services.
4. In the **Auto Update** screen, touch **Yes** to allow the printer to automatically check for and install product updates.

5. If your network uses proxy settings when connecting to the Internet, enter these settings:
 - a. Touch **Enter Proxy**.
 - b. Enter the proxy server settings, and then touch **Done**.
6. Follow the instructions on the Web Services information sheet to finish the setup.

Set up Web Services using the embedded web server

You can use the printer's embedded web server (EWS) to set up and manage Web Services.

To set up Web Services, complete the following steps:

1. Open the EWS. For more information, see [Embedded web server](#).
2. On the **Web Services** tab, click **Setup** in the **Web Services Settings** section.
3. Click the **Continue** button, select **Accept Terms of Use and Enable Web Services**, **Enable Web Services**, and **Update Apps** checkboxes, and then click **Next**.
4. Click **Yes** to allow the printer to automatically check for and install product updates.
5. If your network uses proxy settings when connecting to the Internet, enter these settings.
6. Follow the instructions on the Web Services information sheet to finish the setup.

Use Web Services

The following section describes how to use and configure Web Services.

- [HP ePrint](#)
- [Printer Apps](#)

HP ePrint

HP ePrint allows you to print to your HP ePrint-enabled printer anytime, from any location.

To use HP ePrint, make sure to have the following:

- An Internet- and email-capable computer or mobile device
- An HP ePrint-capable printer on which Web Services has been enabled

 **TIP:** For more information about managing and configuring HP ePrint settings and to learn about the latest features, visit HP Connected (www.hpconnected.com).

Print using HP ePrint

To print documents using HP ePrint, complete the following steps:

1. On your computer or mobile device, open your email application.

 **NOTE:** For information about using the email application on your computer or mobile device, see the documentation provided with the application.

2. Create a new email message, and then attach the file that you want to print. For a list of files that can be printed using HP ePrint, as well as guidelines to follow when using HP ePrint, see [HP ePrint](#).
3. Enter the printer's email address in the "To" line of the email message, and then select the option to send the email message.

 **NOTE:** Make sure that the printer's email address is the only address listed in the "To" line of the email message. If other email addresses are listed in the "To" line, the attachments you are sending might not print.

Find the printer's email address

 **NOTE:** Make sure you have created an ePrint account. To sign up for an account on HP Connected, visit HP Connected at www.hpconnected.com.

From the Home screen, touch  (HP ePrint).

 **TIP:** To print the email address, touch **Print Info**.

Turn off HP ePrint

To turn off HP ePrint, complete the following steps:

1. From the Home screen, touch  (HP ePrint), and then touch **Settings**.
2. Touch **ePrint**, and then touch **Off**.

 **NOTE:** To remove all Web Services, see [Remove Web Services](#).

Printer Apps

Printer Apps allow you to easily locate and print pre-formatted web content, directly from your printer.

Use Printer Apps

To use the Printer Apps on your printer, touch Apps on the printer's control panel display, and then touch the Print App you want to use.

For more information about individual Printer Apps, visit (www.hpconnected.com).

Manage Printer Apps

You can manage your Printer Apps with HP Connected. You can add, configure, or remove Printer Apps, and set the order in which they appear on your printer's display.

 **NOTE:** To manage Printer Apps from HP Connected, create an account on HP Connected and add your printer. For more information, see www.hpconnected.com.

Turn off Printer Apps

To turn off Printer Apps, complete the following steps:

1. From the Home screen, touch  (HP ePrint), and then touch **Settings**.
2. Touch **Apps**, and then touch **Off**.

 **NOTE:** To remove all Web Services, see [Remove Web Services](#).

Remove Web Services

To remove Web Services, complete the following steps:

1. On the printer's control panel display, touch  (HP ePrint), and then touch **Settings**.
2. Touch **Remove Web Services**.

4 Work with ink cartridges

To ensure the best print quality from the printer, you need to perform some simple maintenance procedures. This section provides guidelines for handling the ink cartridges, instructions for replacing the ink cartridges, and aligning and cleaning the printhead.

This section contains the following topics:

- [Information on ink cartridges and the printhead](#)
- [Check the estimated ink levels](#)
- [Print when one or more ink cartridges are depleted](#)
- [Replace the ink cartridges](#)
- [Store printing supplies](#)
- [Anonymous Usage Information Storage](#)

Information on ink cartridges and the printhead

The following tips help maintain HP ink cartridges and ensure consistent print quality.

- The instructions in this user guide are for replacing ink cartridges, and are not intended for first time installation.
- **⚠ CAUTION:** HP recommends that you replace any missing cartridges as soon as possible to avoid print quality issues and possible extra ink usage or damage to the ink system. Never turn off the printer when ink cartridges are missing.
- Keep all ink cartridges in the original sealed packages until they are needed.
- Be sure to turn off the printer properly. For more information, see [Turn the printer off](#).
- Store ink cartridges at room temperature (15-35° C or 59-95° F).
- Do not clean the printhead unnecessarily. This wastes ink and shortens the life of the cartridges.
- Handle ink cartridges carefully. Dropping, jarring, or rough handling during installation can cause temporary printing problems.
- If you are transporting the printer, do the following to prevent ink leaking from the printer or other damage from occurring to the printer:
 - Make sure you turn off the printer by pressing the  (Power button). Wait until all sounds of internal motion stop before unplugging the printer. For more information, see [Turn the printer off](#).
 - Make sure you leave the ink cartridges and printhead installed.
 - The printer must be transported sitting flat; it should not be placed on its side, back, front, or top.

Related topics

- [Check the estimated ink levels](#)
- [Printhead maintenance](#)

Check the estimated ink levels

You can check the estimated ink levels from the printer software or from the printer control panel. For information about using these tools, see [Printer management tools](#) and [Use the printer control panel](#). You can also print the Printer Status page to view this information (see [Understand the Printer Status Report](#)).

 **NOTE:** Ink level alerts and indicators provide estimates for planning purposes only. When you receive a low-ink alert, consider having a replacement cartridge available to avoid possible printing delays. You do not have to replace the cartridges until you are prompted to do so.

NOTE: If you have installed a refilled or remanufactured cartridge, or a cartridge that has been used in another printer, the ink level indicator might be inaccurate or unavailable.

NOTE: Ink from the cartridges is used in the printing process in a number of different ways, including in the initialization process, which prepares the printer and cartridges for printing, and in printhead servicing, which keeps print nozzles clear and ink flowing smoothly. In addition, some residual ink is left in the cartridge after it is used. For more information, see www.hp.com/go/inkusage.

Print when one or more ink cartridges are depleted

The printer can still operate when the black ink cartridge or one or more color ink cartridges are depleted, but it will print more slowly. Also, the quality of printed documents might be affected.

The printer will not be able to print when both the black cartridge and a color cartridge are depleted.

- If the black cartridge is depleted, any black color in printed documents is created using a combination of the remaining colors. As a result, blacks might not appear to be as dark.
- If a color cartridge is depleted, the printer will print in grayscale using the black cartridge.

When possible, replace any depleted ink cartridges. For information about how to install new ink cartridges, see [Replace the ink cartridges](#).

 **CAUTION:** While ink cartridges are not damaged when left outside of the printer, the printhead does need to have all cartridges installed at all times after the printer is set up and in use. Leaving one or more cartridge slots empty for an extended period may lead to print quality problems and possibly damage the printhead. If you have recently left a cartridge out of the printer for an extended period, or if you have had a recent paper jam, and have noticed poor print quality, clean the printhead. For more information, see [Clean the printhead](#).

Replace the ink cartridges

 **NOTE:** For information on recycling used ink supplies, see [HP inkjet supplies recycling program](#)

If you do not already have replacement ink cartridges for the printer, see [Ink cartridges and printheads](#).

 **NOTE:** At this time, some portions of the HP website are available in English only.

NOTE: Not all cartridges are available in all countries/regions.

 **CAUTION:** HP recommends that you replace any missing cartridges as soon as possible to avoid print quality issues and possible extra ink usage or damage to the ink system. Never turn off the printer when ink cartridges are missing.

Use these steps to replace the ink cartridges.

To replace the ink cartridges

1. Make sure the printer is turned on.
 2. Open the ink cartridge access door.
-

 **NOTE:** Wait until the print carriage stops moving before proceeding.

3. Press the front of the ink cartridge to release it, and then remove it from the slot.

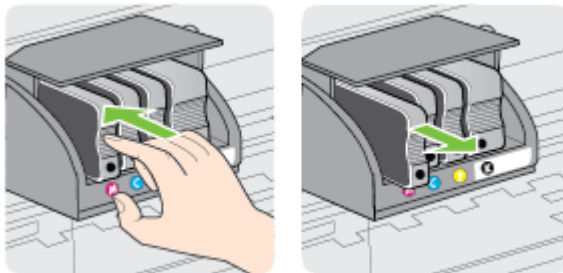

4. Remove the new ink cartridge from its packaging.
 5. Using the color-coded letters for help, slide the ink cartridge into the empty slot until it is securely installed in the slot.
-

 **CAUTION:** Do not lift the latch handle on the print carriage to install the ink cartridges. Doing so could cause the printhead or ink cartridges to be incorrectly seated, which can cause errors or print quality problems. The latch must remain down in order to correctly install the ink cartridges.

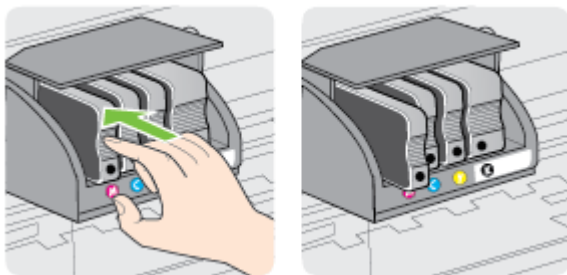

Make sure that you insert the ink cartridge into the slot that has the same colored letter as the color you are installing.



6. Repeat steps 3 through 5 for each ink cartridge you are replacing.
7. Close the ink cartridge access door.

Related topics

[Ink cartridges and printheads](#)

Store printing supplies

Ink cartridges can be left in the printer for extended periods of time. However, to assure optimal ink cartridge health, be sure to turn off the printer properly. For more information, see [Turn the printer off](#).

Anonymous Usage Information Storage

The HP cartridges used with this printer contain a memory chip that assists in the operation of the printer.

In addition, this memory chip stores a limited set of anonymous information about the usage of the printer, which might include the following: the date when the cartridge was first installed, the date when the cartridge was last used, the number of pages printed using the cartridge, the page coverage, frequency of printing, the printing modes used, any printing errors that might have occurred, and the printer model.

This information helps HP design future printers to meet our customers' printing needs. The data collected from the cartridge memory chip does not contain information that can be used to identify a customer or user of the cartridge or their printer.

HP collects a sampling of the memory chips from cartridges returned to HP's free return and recycling program (HP Planet Partners: www.hp.com/hpinfo/globalcitizenship/environment/recycle). The memory chips from this sampling are read and studied in order to improve future HP printers. HP partners who assist in recycling this cartridge might have access to this data, as well.

Any third party possessing the cartridge might have access to the anonymous information on the memory chip. If you prefer to not allow access to this information, you can render the chip inoperable. However, after you render the memory chip inoperable, the cartridge cannot be used in an HP printer.

If you are concerned about providing this anonymous information, you can make this information inaccessible by turning off the memory chip's ability to collect the printer's usage information:

To disable the usage information function

1. On the printer control panel, touch  (right arrow), and then touch **Setup**.
2. Select **Preferences**, and then select **Cartridge Chip Information**.
3. Touch **OK** to turn off usage information collection.

 **NOTE:** To re-enable the usage information function, restore the factory defaults.

NOTE: You can continue to use the cartridge in the HP printer if you turn off the memory chip's ability to collect the printer's usage information.

5 Solve a problem

The information in this section suggests solutions to common problems. If your printer is not operating correctly and these suggestions did not solve your problem, try using one of the following support services to obtain assistance.

This section contains the following topics:

- [HP support](#)
- [General troubleshooting tips and resources](#)
- [Solve printer problems](#)
- [Print quality troubleshooting](#)
- [Solve paper-feed problems](#)
- [Solve problems using Web Services and HP websites](#)
- [Solve memory device problems](#)
- [Solve Ethernet network problems](#)
- [Solve wireless problems](#)
- [Configure your firewall software to work with the printer](#)
- [Solve printer management problems](#)
- [Troubleshoot installation issues](#)
- [Solve network problems](#)
- [Understand the Printer Status Report](#)
- [Printhead maintenance](#)
- [Understand the network configuration page](#)
- [Clear jams](#)

HP support

If you have a problem, follow these steps

1. Check the documentation that came with the printer.
2. Visit the HP online support website at www.hp.com/support. This website provides information and utilities that can help you correct many common printer problems. HP online support is available to all HP customers. It is the fastest source for up-to-date printer information and expert assistance and includes the following features:
 - Fast access to qualified online support specialists
 - HP software and driver updates for the HP printer
 - Valuable troubleshooting information for common problems
 - Proactive printer updates, support alerts, and HP newsgrams that are available when you register the printer

For more information, see [Obtain electronic support](#).

3. Call HP support. Support options and availability vary by printer, country/region, and language. For more information, see [HP support by phone](#).

Obtain electronic support

To find support and warranty information, go to the HP website at www.hp.com/support. This website provides information and utilities that can help you correct many common printer problems. If prompted, select your country/region, and then click **Contact HP** for information about calling for technical support.

This website also offers technical support, drivers, supplies, ordering information and other options such as:

- Access online support pages.
- Send HP an email message for answers to your questions.
- Connect with an HP technician by using online chat.
- Check for HP software updates.

You can also obtain support from the HP software for Windows or Mac OS X, which provide easy, step-by-step solutions to common printing problems. For more information, see [Printer management tools](#).

Support options and availability vary by printer, country/region, and language.

HP support by phone

The phone support numbers and associated costs listed here are those in effect at time of publication and are applicable only for calls made on a land line. Different rates may apply for mobile phones.

For the most current HP list of telephone support numbers and call costs information, see www.hp.com/support. This website provides information and utilities that can help you correct many common printer problems.

During the warranty period, you may obtain assistance from the HP Customer Care Center.

 **NOTE:** HP does not provide telephone support for Linux printing. All support is provided online at the following website: <https://launchpad.net/hplip>. Click the **Ask a question** button to begin the support process.

The HPLIP website does not provide support for Windows or Mac OS X. If you are using these operating systems, see www.hp.com/support. This website provides information and utilities that can help you correct many common printer problems.

This section contains the following topics:

- [Before you call](#)
- [Phone support period](#)
- [After the phone support period](#)

Before you call

Call HP support while you are in front of the computer and the printer. Be prepared to provide the following information:

- Model number
- Serial number (located on the back or bottom of the printer)

- Messages that appear when the situation occurs
- Answers to these questions:
 - Has this situation happened before?
 - Can you re-create it?
 - Did you add any new hardware or software to your computer at about the time that this situation began?
 - Did anything else occur prior to this situation (such as a thunderstorm or moving the printer)?

Phone support period

One year of phone support is available in North America, Asia Pacific, and Latin America (including Mexico).

After the phone support period

After the phone support period, help is available from HP at an additional cost. Help may also be available at the HP online support website: www.hp.com/support. This website provides information and utilities that can help you correct many common printer problems. Contact your HP dealer or call the support phone number for your country/region to learn more about support options.

General troubleshooting tips and resources

 **NOTE:** Many of the following steps require HP software. If you did not install the HP software, you can install it using the HP software CD included with the printer, or you can download the HP software from the HP support website www.hp.com/support. This website provides information and utilities that can help you correct many common printer problems.

Check or do the following before you begin troubleshooting:

- Try turning the printer off and then on again.
- For a paper jam, see [Clear jams](#).
- For paper-feed problems, such as the paper skew and paper pick, see [Solve paper-feed problems](#).
-  (Power button) light is on and not blinking. When the printer is turned on for the first time, it takes approximately 12 minutes to initialize it after the ink cartridges are installed.
- Power cord and other cables are working, and are firmly connected to the printer. Make sure the printer is connected firmly to a functioning alternating current (AC) power outlet, and is turned on. For voltage requirements, see [Electrical specifications](#).
- Media is loaded correctly in the input tray and is not jammed in the printer.
- All packing tapes and materials are removed.
- The printer is set as the current or default printer. For Windows, set it as the default in the Printers folder. For Mac OS X, set it as the default in the **Print & Fax** or **Print & Scan** section of the **System Preferences**. See your computer's documentation for more information.

- **Pause Printing** is not selected if you are using a computer running Windows.
- You are not running too many programs when you are performing a task. Close programs that you are not using or restart the computer before attempting the task again.

Solve printer problems

 **TIP:** You can visit the HP online support website at www.hp.com/support for information and utilities that can help you correct many common printer problems.

This section contains the following topics:

- [The printer shuts down unexpectedly](#)
- [Alignment fails](#)
- [The printer is not responding \(nothing prints\)](#)
- [The printer prints slowly](#)
- [The printer is making some unexpected noises](#)
- [Blank or partial page printed](#)
- [Something on the page is missing or incorrect](#)
- [Placement of the text or graphics is wrong](#)

The printer shuts down unexpectedly

Check the power and power connections

Make sure the printer is connected firmly to a functioning alternating current (AC) power outlet. For voltage requirements, see [Electrical specifications](#).

Alignment fails

If the alignment process fails, make sure you have loaded unused, plain white paper into the input tray. If you have colored paper loaded in the input tray when you align the printer, the alignment fails.

If the alignment process fails repeatedly, you may need to clean the printhead, or you might have a defective sensor. To clean the printhead, see [Clean the printhead](#).

If cleaning the printhead does not solve the problem, contact HP support. Go to www.hp.com/support. This website provides information and utilities that can help you correct many common printer problems. If prompted, select your country/region, and then click **Contact HP** for information on calling for technical support.

The printer is not responding (nothing prints)

There are print jobs stuck in the print queue

Open the print queue, cancel all documents, and then reboot the computer. Try to print after the computer reboots. Refer to the Help system for the operating system for more information.

Check the printer setup

For more information, see [General troubleshooting tips and resources](#).

Check the HP software installation

If the printer is turned off when printing, an alert message should appear on your computer screen; otherwise, the HP software provided with the printer might not be installed correctly. To resolve this, uninstall the HP software completely, and then reinstall the HP software. For more information, see [Uninstall and reinstall the HP software](#).

Check the cable connections

- Make sure both ends of the USB cable or Ethernet cable are secure.
- If the printer is connected to a network, check the following:
 - Check the Link light on the back of the printer.
 - Make sure you are not using a phone cord to connect the printer.

Check any personal firewall software installed on the computer

The personal software firewall is a security program that protects a computer from intrusion. However, the firewall might block communication between the computer and the printer. If there is a problem communicating with the printer, try temporarily disabling the firewall. If the problem persists, the firewall is not the source of the communication problem. Re-enable the firewall.

The printer prints slowly

Try the following solutions if the printer is printing very slowly.

- [Solution 1: Use a lower print quality setting](#)
- [Solution 2: Check the ink levels](#)
- [Solution 3: Contact HP support](#)

Solution 1: Use a lower print quality setting

Solution: Check the print quality setting. **Best** and **Maximum dpi** provide the best quality but are slower than **Normal** or **Draft**. **Draft** provides the fastest print speed.

Cause: The print quality was set to a high setting.

If this did not solve the issue, try the next solution.

Solution 2: Check the ink levels

Solution: Check the estimated ink levels in the ink cartridges.

 **NOTE:** Ink level alerts and indicators provide estimates for planning purposes only. When you receive a low on ink message, consider having a replacement cartridge available to avoid possible printing delays. You do not need to replace the ink cartridges until prompted to do so.

NOTE: The printer can operate with one or more depleted cartridges. However, printing with depleted cartridges slows the printer and affects the quality of printed documents. If the black cartridge is depleted, blacks are not as dark. If a color cartridge is depleted, output is in grayscale. When possible, replace the depleted cartridge. Do not remove the depleted cartridge until you have a new ink cartridge available. For information about how to install new cartridges, see [Replace the ink cartridges](#).

⚠ CAUTION: While ink cartridges are not damaged when left outside of the printer, the printhead does need to have all cartridges installed at all times after the printer is set up and in use. Leaving one or more cartridge slots empty for an extended period may lead to print quality problems and possibly damage the printhead. If you have recently left a cartridge out of the printer for an extended period, or if you have had a recent paper jam, and have noticed poor print quality, clean the printhead. For more information, see [Clean the printhead](#).

For more information, see:

[Check the estimated ink levels](#)

Cause: The ink cartridges might have insufficient ink. Printing with depleted cartridges slows the printer.

If this did not solve the issue, try the next solution.

Solution 3: Contact HP support

Solution: Contact HP support for service.

Go to: www.hp.com/support. This website provides information and utilities that can help you correct many common printer problems.

If prompted, choose your country/region, and then click **Contact HP** for information on calling for technical support.

Cause: There was a problem with the printer.

The printer is making some unexpected noises

You might hear some unexpected noises made by the printer. These are the servicing sounds when the printer performs automatic servicing functions to maintain the health of the printhead.

📝 NOTE: To prevent any potential damage to your printer:



Do not turn off the printer while the printer is performing any servicing. If you are turning off the printer, wait for the printer to come to a complete stop before turning it off using the  (Power button). For more information, see [Turn the printer off](#).

Make sure all ink cartridges are installed. If any of the ink cartridge is missing, the printer will perform extra servicing to protect the printhead.

Blank or partial page printed

Clean the printhead

Complete the printhead cleaning procedure. For more information, see [Clean the printhead](#). The printhead may need to be cleaned if the printer was turned off incorrectly.

 **NOTE:** Incorrectly turning off the printer can cause print quality problems like blank or partial pages. Printhead cleaning can solve these problems, but turning off the printer correctly can prevent them in the first place. Always turn the printer off by pressing the  (Power button) on the printer. Wait until the  (Power button) light goes out before unplugging the power cord or turning off a power strip.

Check the media settings

- Make sure you select the correct print quality settings in the printer driver for the media loaded in the trays.
- Make sure the page settings in the printer driver match the page size of media loaded in the tray.

More than one page is being picked

For more information, see [Solve paper-feed problems](#).

There is a blank page in the file

Check the file to make sure there is no blank page.

Something on the page is missing or incorrect

Check the Print Quality Diagnostic page

Print a Print Quality Diagnostic page to help you decide whether to run any maintenance tools to improve the print quality of your printouts. For more information, see [Print quality troubleshooting](#).

Check the margin settings

Make sure the margin settings for the document do not exceed the printable area of the printer. For more information, see [Set minimum margins](#).

Check the color print settings

Make sure **Print in Grayscale** is not selected in the printer driver.

Check the printer location and length of USB cable

High electromagnetic fields (such as those generated by USB cables) can sometimes cause slight distortions to printouts. Move the printer away from the source of the electromagnetic fields. Also, it is recommended that you use a USB cable that is less than 3 meters (9.8 feet) long to minimize the effects of these electromagnetic fields.

Placement of the text or graphics is wrong

Check how the media is loaded

Make sure the media width and length guides fit snugly against the edges of the stack of media, and make sure the tray is not overloaded. For more information, see [Load paper](#).

Check the media size

- Content on a page might be cut off if the document size is larger than the media that you are using.
- Make sure the media size selected in the printer driver match the size of media loaded in the tray.

Check the margin settings

If the text or graphics are cut off at the edges of the page, make sure the margin settings for the document do not exceed the printable area of your printer. For more information, see [Set minimum margins](#).

Check the page-orientation setting

Make sure the media size and page orientation selected in the application match the settings in the printer driver. For more information, see [Print](#).

Check the printer location and length of USB cable

High electromagnetic fields (such as those generated by USB cables) can sometimes cause slight distortions to printouts. Move the printer away from the source of the electromagnetic fields. Also, it is recommended that you use a USB cable that is less than 3 meters (9.8 feet) long to minimize the effects of these electromagnetic fields.

If the above solutions do not work, the problem may be caused by the inability of the application to interpret print settings correctly. See the release notes for known software conflicts, refer to the application's documentation, or contact the software manufacturer for specific help.

Print quality troubleshooting

Try the solutions in this section to resolve print quality problems in your printout.

 **TIP:** You can visit the HP online support website at www.hp.com/support for information and utilities that can help you correct many common printer problems.

- [Solution 1: Make sure you are using genuine HP ink cartridges](#)
- [Solution 2: Check the ink levels](#)
- [Solution 3: Check the paper loaded in the input tray](#)
- [Solution 4: Check the paper type](#)
- [Solution 5: Check the print settings](#)
- [Solution 6: Print and evaluate a print quality report](#)
- [Solution 7: Contact HP support](#)

Solution 1: Make sure you are using genuine HP ink cartridges

Solution: Check to see if your ink cartridges are genuine HP ink cartridges.

HP recommends that you use genuine HP ink cartridges. Genuine HP ink cartridges are designed and tested with HP printers to help you easily produce great results, time after time.

 **NOTE:** HP cannot guarantee the quality or reliability of non-HP supplies. Printer service or repairs required as a result of using a non-HP supply are not covered under warranty.

If you believe you purchased genuine HP ink cartridges, go to:

www.hp.com/go/anticounterfeit

Cause: Non-HP ink cartridges were being used.

If this did not solve the issue, try the next solution.

Solution 2: Check the ink levels

Solution: Check the estimated ink levels in the ink cartridges.

 **NOTE:** Ink level alerts and indicators provide estimates for planning purposes only. When you receive a low-ink alert, consider having a replacement cartridge available to avoid possible printing delays. You do not need to replace the ink cartridges until prompted to do so.

NOTE: The printer can operate with one or more depleted cartridges. However, printing with depleted cartridges slows the printer and affects the quality of printed documents. If the black cartridge is depleted, blacks are not as dark. If a color cartridge is depleted, output is in grayscale. When possible, replace the depleted cartridge. Do not remove the depleted cartridge until you have a new ink cartridge available. For information about how to install new cartridges, see [Replace the ink cartridges](#).

 **CAUTION:** While ink cartridges are not damaged when left outside of the printer, the printhead does need to have all cartridges installed at all times after the printer is set up and in use. Leaving one or more cartridge slots empty for an extended period may lead to print quality problems and possibly damage the printhead. If you have recently left a cartridge out of the printer for an extended period, or if you have had a recent paper jam, and have noticed poor print quality, clean the printhead. For more information, see [Clean the printhead](#).

For more information, see:

[Check the estimated ink levels](#)

Cause: The ink cartridges might have insufficient ink.

If this did not solve the issue, try the next solution.

Solution 3: Check the paper loaded in the input tray

Solution: Make sure the paper is loaded correctly and that it is not wrinkled or too thick.

- Load paper with the print side facing down. For example, if you are loading glossy photo paper, load the paper with the glossy side down.
- Make sure the paper lays flat in the input tray and is not wrinkled. If the paper is too close to the printhead during printing, the ink might be smeared. This can happen if the paper is raised, wrinkled, or very thick, such as a mailing envelope.

For more information, see:

[Load paper.](#)

Cause: The paper was loaded incorrectly, or it was wrinkled or too thick.

If this did not solve the issue, try the next solution.

Solution 4: Check the paper type

Solution: HP recommends that you use HP papers or any other paper type with ColorLok technology that is appropriate for the printer. All papers with the ColorLok logo are independently tested to meet high standards of reliability and print quality, and produce documents with crisp, vivid color, bolder blacks and dry faster than ordinary plain papers.

Always make sure the paper you are printing on is flat. For best results when printing images, use HP Advanced Photo Paper.

Store specialty media in its original packaging inside a resealable plastic bag on a flat surface in a cool, dry place. When you are ready to print, remove only the paper you plan to use immediately. When you have finished printing, return any unused photo paper to the plastic bag. This prevents the photo paper from curling.

 **NOTE:** For this issue, there is not a problem with your ink supplies. Therefore, replacing the ink cartridges is not necessary.

For more information, see:

[Select paper](#)

Cause: The wrong kind of paper was loaded in the input tray.

If this did not solve the issue, try the next solution.

Solution 5: Check the print settings

Solution: Check the print settings.

- Check the print settings to see if the color settings are incorrect. For example, check to see if the document is set to print in grayscale. Or, check to see if advanced color settings such as saturation, brightness, or color tone, are set to modify the appearance of colors.
- Check the print quality setting and make sure it matches the type of paper loaded in the printer. You might need to choose a lower print quality setting if colors are running into each other. Or, choose a higher setting if you are printing a high-quality photo, and then make sure photo paper such as HP Advanced Photo Paper is loaded in the input tray.

 **NOTE:** On some computer screens, colors might appear differently than they do when printed on paper. In this case, there is nothing wrong with the printer, print settings, or ink cartridges. No further troubleshooting is required.

For more information, see:

[Select paper](#)

Cause: The print settings were set incorrectly.

If this did not solve the issue, try the next solution.

Solution 6: Print and evaluate a print quality report

Solution:

To print a print quality report

- **Control panel:** Touch  (right arrow), and then touch **Setup**, select **Reports**, and then select **Print Quality Report**.
- **Embedded web server:** Click the **Tools** tab, click **Print Quality Toolbox** under **Utilities**, and then click **Print Quality Report** button.
- **HP Utility (Mac OS X):** In the **Information And Support** section, click **Print Quality Diagnostics**, and then click **Print**.

HP Officejet Pro 2510w Printer Series
Print Quality Diagnostic Page

Printer Information

Product number: C1103A
Product serial number: 0N10M101040202
Service ID: 21350
Printer model: E5L3CA2200E
Pages printed: Tray 1=2075, Tray 2=0, Total=2075, AutoStopX on=07
Ink cartridges: 1=BL, 2=CY, 3=M, 4=Y, 5=C, 6=0

*Calibrates only. Actual ink levels may vary.

Test Pattern 1

If you see dark lines or white gaps when the areas are printing, calibrate linefeed.

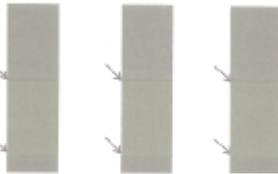

Test Pattern 2

If the lines are not straight and connected, align the printhead.



Test Pattern 3

If you see white or less saturation of the color bars, clean the printhead.



If defects are seen on the Print Quality Diagnostic report, follow the steps below:

1. If the Print Quality Diagnostic report shows faded, partial, streaked, or missing color bars or patterns, check for depleted ink cartridges, and replace the ink cartridge that corresponds to the defective color bar or color pattern. If there is no depleted ink cartridge, remove and reinstall all ink cartridges to make sure they are properly installed. Do not remove the depleted cartridge until you have a new ink cartridge available to replace. For information about how to install new cartridges, see [Replace the ink cartridges](#).
2. Calibrate the linefeed. For more information, see [Calibrate the linefeed](#).
3. Align the printhead. For more information, see [Align the printhead](#).
4. Clean the printhead. For more information, see [Clean the printhead](#).
5. If none of the previous steps have helped, contact HP support to replace the printhead. For more information, see [HP support](#).

Cause: Print quality problems can have many causes: software settings, a poor image file, or the printing system itself. If you are unhappy with the quality of your prints, a Print Quality Diagnostic page can help you determine if the printing system is working correctly.

Solution 7: Contact HP support

Solution: Contact HP support for service.

Go to: www.hp.com/support. This website provides information and utilities that can help you correct many common printer problems.

If prompted, choose your country/region, and then click **Contact HP** for information on calling for technical support.

Cause: There was a problem with the printhead.

Solve paper-feed problems

 **TIP:** You can visit the HP online support website at www.hp.com/support for information and utilities that can help you correct many common printer problems.

Media is not supported for the printer or tray

Use only media that is supported for the printer and the tray being used. For more information, see [Paper specifications](#).

Media is not picked up from a tray

- Make sure media is loaded in the tray. For more information, see [Load paper](#). Fan the media before loading.
- Make sure the paper guides are set to the correct markings in the tray for the media size you are loading. Also make sure the guides are snug, but not tight, against the stack.
- Make sure media in the tray is not curled. Uncurl paper by bending it in the opposite direction of the curl.

Media is not coming out correctly

- Make sure the output tray extension is fully extended; otherwise, printed pages may fall off the printer.

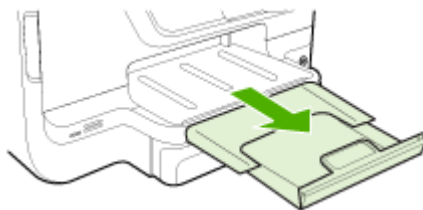

- Remove excess media from the output tray. There is a limit to the number of sheets the tray can hold.

Pages are skewing

- Make sure the media loaded in the trays is aligned to the paper guides. If needed, pull out the trays from the printer and reload the media correctly, making sure that the paper guides are aligned correctly.
- Load media into the printer only when it is not printing.
- Remove and replace the automatic two-sided printing accessory (duplexer).
 - Push the button on either side of the duplexer, and then remove the unit.

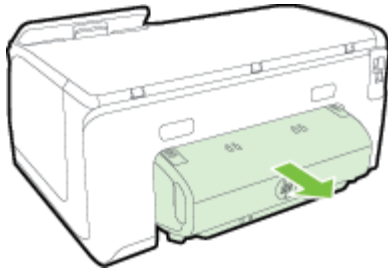

- Reinsert the duplexer into the printer.

Multiple pages are being picked up

- Fan the media before loading.
- Make sure the paper guides are set to the correct markings in the tray for the media size you are loading. Also make sure the guides are snug, but not tight, against the stack.
- Make sure the tray is not overloaded with paper.
- When using thin special media, make sure that the tray is completely loaded. If you are using special media that is only available in small quantities, try placing the special media on top of other paper of the same size to help fill the tray. (Some media is picked up more easily if the tray is full.)
- If you are using thick special media (such as brochure paper), load media so that the tray is between 1/4 and 3/4 full. If necessary, place the media on top of other paper of the same size so that the stack height is within this range.
- Use HP media for optimum performance and efficiency.

Solve problems using Web Services and HP websites

This section provides solutions to common problems using Web Services and HP websites.

- [Solve problems using Web Services](#)
- [Solve problems using HP websites](#)

Solve problems using Web Services

If you are having problems using Web Services, such as HP ePrint and Printer Apps, check the following:

- Make sure the printer is connected to the Internet using an Ethernet or wireless connection.



NOTE: You cannot use these web features if the printer is connected using a USB cable.

- Make sure the latest product updates have been installed on the printer. For more information, see [Update the printer](#).
- Make sure Web Services is enabled on the printer. For more information, see [Set up Web Services using the printer's control panel](#).
- Make sure the network hub, switch, or router is turned on and working correctly.
- If you are connecting the printer using an Ethernet cable, make sure you are not connecting the printer using a phone cord or a crossover cable to connect the printer to the network and that the Ethernet cable is securely connected to the printer. For more information, see [Solve Ethernet network problems](#).
- If you are connecting the printer using a wireless connection, make sure the wireless network is functioning properly. For more information, see [Solve wireless problems](#).
- If you are using HP ePrint, check the following:
 - Make sure the printer's email address is correct.
 - Make sure that the printer's email address is the only address listed in the "To" line of the email message. If other email addresses are listed in the "To" line, the attachments you are sending might not print.
 - Make sure you are sending documents that meet the HP ePrint requirements. For more information, see [Web Services specifications](#).
- If your network uses proxy settings when connecting to the Internet, make sure the proxy settings you are entering are valid:
 - Check the settings being used by the Web browser you are using (such as Internet Explorer, Firefox, or Safari).
 - Check with the IT administrator or person who set up your firewall.
If the proxy settings used by your firewall have changed, you must update these settings in either the printer's control panel. If these settings are not updated, you will not be able to use Web Services.
For more information, see [Set up Web Services using the printer's control panel](#).



TIP: For additional help on setting up and using Web Services, visit HP Connected (www.hpconnected.com).

Solve problems using HP websites

If you are having problems using HP websites from your computer, check the following:

- Make sure the computer that you are using is connected to the Internet.
- Make sure the web browser meets the minimum system requirements. For more information, see [HP website specifications](#).
- If your web browser uses any proxy settings to connect to the Internet, try turning off these settings. For more information, see the documentation provided with your web browser.

Solve memory device problems

 **TIP:** You can visit the HP online support website at www.hp.com/support for information and utilities that can help you correct many common printer problems.

 **NOTE:** If you are starting a memory device operation from a computer, see the software Help for troubleshooting information.

- [The printer cannot read the memory device](#)
- [The printer cannot read photos on the memory device](#)

The printer cannot read the memory device

- **Check the memory device**
 - Make sure that the memory device is one of the supported types. For more information, see [Memory device specifications](#).
 - Some memory devices have a switch that controls how they can be used. Make sure that the switch is set so that the memory device can be read.
 - Inspect the ends of the memory device for dirt or material that closes a hole or spoils a metal contact. Clean the contacts with a lint-free cloth and small amounts of isopropyl alcohol.
 - Make sure that the memory device is working correctly by testing it with other devices. If the files can be access using a computer, the device may still not work with the printer.
- **Check the USB port**
 - Make sure that the USB cable is fully inserted into the port.
 - Remove the USB cable and shine a flashlight into the empty port. See if there is any debris in the port. For more information, see [HP support](#). This website provides information and utilities that can help you correct many common printer problems.

The printer cannot read photos on the memory device

Check the memory device

The memory device might be corrupt.

Solve Ethernet network problems

 **TIP:** You can visit the HP online support website at www.hp.com/support for information and utilities that can help you correct many common printer problems.

If you are unable to connect the printer to your Ethernet network, perform one or more of the following tasks.

 **NOTE:** After correcting any of the following, run the installation program again.

- [General network troubleshooting](#)

General network troubleshooting

If you are unable to install the HP software provided with the printer, verify that:

- All cable connections to the computer and the printer are secure.
- The network is operational and the network hub, switch, or router is turned on.
- All applications, including virus protection programs, spyware protection programs, and firewalls, are closed or disabled for computers running Windows.
- The printer is installed on the same subnet as the computers that use the printer.

Solve wireless problems

This section provides information about solving problems you might encounter when connecting the printer to your wireless network.

Follow these suggestions in order, starting with those listed in the "Basic wireless troubleshooting" section. If you still encounter problems, follow the suggestions provided in the "Advanced wireless troubleshooting" section.

This section contains the following topics:

- [Basic wireless troubleshooting](#)
- [Advanced wireless troubleshooting](#)
- [After resolving the problems](#)

 **TIP:** For more information about troubleshooting wireless problems, visit the HP Wireless Printing Center www.hp.com/go/wirelessprinting.

 **NOTE:** After you resolve the problem, follow the instructions in [After resolving the problems](#).

Basic wireless troubleshooting

 **NOTE:** If you have not configured the printer for wireless connection, use the HP software to complete the setup. For more information, see .

Perform the following steps in the order presented.

 **TIP:** If you are using a computer running Windows, use the HP Print and Scan Doctor to help diagnose and get assistance in installing and using HP printers on home network. To use this tool, visit the HP Wireless Printing Center www.hp.com/go/wirelessprinting.

Step 1 - Make sure the wireless (802.11) light is turned on

The Wireless light in the printer control panel indicates the status of the wireless capabilities.

To turn on wireless, touch , touch **Setup**, touch **Network**, touch **Wireless Radio**, and then select **Yes**.

 **NOTE:** If your printer supports Ethernet networking, make sure that an Ethernet cable has not been connected to the printer. Connecting an Ethernet cable turns off the printer's wireless capabilities.

Step 2 - Restart components of the wireless network



Turn off the router and the printer, and then turn them back on in this order: router first and then the printer. If you still are unable to connect, turn off the router, printer, and your computer. Sometimes, turning off the power and then turning it back on recovers from a network communication issue.

Step 3 - Run the Print Wireless Network Test

For wireless networking issues, run the Print Wireless Network Test. If a problem is detected, the printed test report includes recommendations that might help solve the problem.

 **TIP:** If the Print Wireless Network Test indicates the signal is weak, try moving the printer closer to the wireless router.

To print a wireless network test page

1. Touch , touch **Setup**, and then touch **Network**.
2. Touch , and then select **Print Wireless Test Report**.

Advanced wireless troubleshooting

If you have tried the suggestions provided in [Basic wireless troubleshooting](#) and are still unable to connect to your printer to the wireless network, try the following suggestions in the order presented:

- [Step 1 - Make sure your computer is connected to your network](#)
- [Step 2 - Make sure that the printer is connected to your network](#)
- [Step 3 - Make sure your computer is not connected to your network over a Virtual Private Network \(VPN\)](#)
- [Step 4 - Make sure the printer is online and ready](#)
- [Step 5 - Make sure the wireless version of the printer is set as the default printer driver \(Windows only\)](#)
- [Step 6 - Check to see if the firewall software is blocking communication](#)

Step 1 - Make sure your computer is connected to your network

Make sure your computer is connected to your network - either your Ethernet network or your wireless network. If the computer is not connected to the network, you cannot use the printer over the network.

To check an Ethernet connection

Many computers have indicator lights beside the port where the Ethernet cable connects to your computer. If the lights are not on, try reconnecting the Ethernet cable to the computer and the router. If you still do not see lights, there might be a problem with the router, the Ethernet cable, or your computer.

 **NOTE:** Mac computers do not have indicator lights. To check the Ethernet connection on a Mac, click **System Preferences** in the Dock, and then click **Network**. If the Ethernet connection is working correctly, **Built-in Ethernet** appears in the list of connections, along with the IP address and other status information. If **Built-in Ethernet** does not appear in the list, there might be a problem with the router, the Ethernet cable, or your computer. For more information, click the Help button in the window.

To check a wireless connection

1. Make sure that your computer's wireless has been turned on. (For more information, see the documentation that came with your computer.)
2. If you are not using a unique wireless network name (SSID), then it is possible that your wireless computer could be connected to a nearby network that is not yours. The following steps can help you determine if your computer is connected to your network:

Windows

- a. Click **Start**, click **Control Panel**, point to **Network Connections**, and then click **View Network Status and Tasks**.
- Or -
Click **Start**, select **Settings**, click **Control Panel**, double-click **Network Connections**, click the **View** menu, and then select **Details**.
Leave the network dialog box open while you continue to the next step.
- b. Disconnect the power cord from the wireless router. The connection status of your computer should change to **Not Connected**.
- c. Reconnect the power cord to the wireless router. The connection status should change to **Connected**.

Mac OS X

- ▲ Click the AirPort icon in the menu bar at the top of the screen. From the menu that appears, you can determine if the AirPort is turned on and which wireless network your computer is connected to.



NOTE: For more detailed information about your AirPort connection, click **System Preferences** in the Dock, and then click **Network**. If the wireless connection is working correctly, a green dot appears next to AirPort in the list of connections. For more information, click the Help button in the window.

If you are unable to get your computer connected to your network, contact the person who set up your network or the router manufacturer as there might be a hardware issue with either your router or computer.



TIP: If you are able to access the Internet and are using a computer running Windows, you can also use the HP Network Assistant for help in setting up a network. To use this tool, visit www.hp.com/sbso/wireless/tools-setup.html?jumpid=reg_R1002_USEN. (This Web site is only available in English.)

Step 2 - Make sure that the printer is connected to your network

If your printer is not connected to the same network as your computer, you cannot use the printer over the network. Follow the steps described in this section to find out if your printer is actively connected to the correct network.



NOTE: If your wireless router or Apple AirPort Base Station is using a hidden SSID, your printer cannot automatically detect the network.

A: Make sure the printer is on the network

1. If the printer supports Ethernet networking and is connected to an Ethernet network, make sure an Ethernet cable is not plugged into the back of the printer. If an Ethernet cable is plugged into the back, then wireless connectivity is disabled.
2. If the printer is connected to a wireless network, print the network configuration page. For more information, see [Understand the network configuration page](#).
3. After the page has been printed, check the Network Status and URL:

Network Status	<ul style="list-style-type: none">• If the Network Status is Ready, the printer is actively connected to a network.• If the Network Status is Offline, the printer is not connected to a network. Run the Print Wireless Network Test (using the instructions at the beginning of this section) and follow any recommendations.
URL	The URL shown here is the network address assigned to the printer by your router. You need this to connect to the embedded web server (EWS).

For information about connecting the printer to a wireless network, see [Set up the printer for wireless communication](#).

B: Check to see if you can access the EWS

After you establish that the computer and the printer both have active connections to a network, you can verify if they are on the same network by opening the printer's EWS. For more information, see [Embedded web server](#).

To access the EWS

1. On your computer, open the EWS. For more information, see [Embedded web server](#).



NOTE: If you are using a proxy server in your browser, you might need to disable it to access the EWS.

2. If you can open the EWS, try using the printer over the network (such as to print) to see if your network setup was successful.

If you cannot open the EWS or are still having problems using the printer over the network, continue to the next section regarding firewalls.

Step 3 - Make sure your computer is not connected to your network over a Virtual Private Network (VPN)

A Virtual Private Network (VPN) is a computer network that uses the Internet to provide a remote, secure connection to an organization's network. However, most VPN services do not allow you to access local devices (like your printer) on your local network while your computer is connected to the VPN.

To connect to the printer, disconnect from the VPN.



TIP: To use the printer while connected to the VPN, you can connect the printer to your computer with a USB cable. The printer uses its USB and network connections at the same time.

For more information, contact your network administrator or the person who set up the wireless network.

Step 4 - Make sure the printer is online and ready

If you have the HP software installed, you can check the printer's status from your computer to see if the printer is paused or offline, preventing you from using it.

To check the printer's status, follow the instructions for your operating system:

Windows

1. Click **Start**, and then click **Printers** or **Printers and Faxes** or **Devices and Printers**.

- Or -

Click **Start**, click **Control Panel**, and then double-click **Printers**.

2. If the printers on your computer are not being displayed in Details view, click the **View** menu, and then click **Details**.

3. Do one of the following, depending on the printer status:
 - a. If the printer is **Offline**, right-click the printer, and click **Use Printer Online**.
 - b. If the printer is **Paused**, right-click the printer, and click **Resume Printing**.
4. Try using the printer over the network.

Mac OS X

1. Click **System Preferences** in the Dock, and then click **Print & Fax** or **Print & Scan**.
2. Select the printer, and then click **Open Print Queue**.
3. If the print job is on hold, click **Resume**.
4. If the printer is paused, click **Resume Printer**.

If you can use the printer after performing the steps above but find that the symptoms persist as you continue to use the printer, your firewall might be interfering. For more information, see [Configure your firewall software to work with the printer](#).

If you still cannot use the printer over the network, continue to the next section for additional troubleshooting help.

Step 5 - Make sure the wireless version of the printer is set as the default printer driver (Windows only)

If you install the HP software again, the installer might create a second version of the printer driver in your **Printers** or **Printers and Faxes** or **Devices and Printers** folder. If you have difficulties printing or connecting to the printer, make sure the correct version of the printer driver is set as the default.

1. Click **Start**, and then click **Printers** or **Printers and Faxes** or **Devices and Printers**.
- Or -
Click **Start**, click **Control Panel**, and then double-click **Printers**.
2. Determine if the version of the printer driver in the **Printers** or **Printers and Faxes** or **Devices and Printers** folder is connected wirelessly:
 - a. Right-click the printer icon, and then click **Properties**, **Document Defaults**, or **Printing Preferences**.
 - b. On the **Ports** tab, look for a port in the list with a checkmark. The version of the printer driver that is connected wirelessly has **HP network re-discovery port monitor** as the Port description, next to the checkmark.
3. Right-click the printer icon for the version of the printer driver that is connected wirelessly, and select **Set as Default Printer**.

 **NOTE:** If there is more than one icon in the folder for the printer, right-click the printer icon for the version of the printer driver that is connected wirelessly, and select **Set as Default Printer**.

Step 6 - Check to see if the firewall software is blocking communication

If you cannot access the EWS and are sure both the computer and printer have active connections to the same network, the firewall security software might be blocking communication. Temporarily turn off any firewall security software running on your

computer and then try to open the EWS again. If you can open the EWS, try using the printer (for printing).

If you are able to open the EWS and use your printer with the firewall turned off, you need to reconfigure your firewall settings to allow the computer and printer to communicate with each other over the network. For more information, see [Configure your firewall software to work with the printer](#).

If you are able to open the EWS, but are still unable to use the printer even with the firewall turned off, try enabling the firewall software to recognize the printer. For more information, see the documentation provided with your firewall software.

After resolving the problems

After you resolve any problems and have successfully connected the printer to your wireless network, complete the following steps for your operating system:

Windows

1. On the computer desktop, click **Start**, select **Programs** or **All Programs**, click **HP**, click the name for the folder, and then click **Printer Setup & Software**.
- Or -
On the **Start** screen, click **Printer Setup & Software**.
2. Click **Connect a new printer**, and then select the type of connection you want to use.

Mac OS X

1. Open HP Utility. For more information, see [HP Utility \(Mac OS X\)](#).
2. Click the **Applications** icon on the HP Utility toolbar, double-click **HP Setup Assistant**, and then follow the onscreen instructions.

Configure your firewall software to work with the printer

A personal firewall, which is security software running on your computer, can block network communication between your printer and your computer.

If you are having problems such as:

- Printer not found when installing HP software
- Unable to print, print job stuck in queue or printer goes offline
- Unable to see printer status on your computer

The firewall might be preventing your printer from notifying computers on your network where it can be found.

If you are using the HP software on a computer running Windows and cannot find the printer during installation (and you know the printer is on the network)—or if you have already successfully installed HP software and experience problems—check the following:

- If you have just installed the HP software, try turning off your computer and the printer, and then turning them both on again.
- Keep your security software up to date. Many security software vendors provide updates that correct known issues and provide the latest defenses against new security threats.

- If your firewall has "High", "Medium", or "Low" security settings, use the "Medium" setting when your computer is connected to your network.
- If you have changed any firewall settings from default, try going back to the default setting.
- If your firewall has a setting called "trusted zone", use this setting when your computer is connected to your network.
- If your firewall has a setting to "not show alert messages", you should disable this. When installing the HP software and using the HP printer you may see alert messages from your firewall software that provide options to "allow", "permit" or "unblock". You should allow any HP software that causes an alert. Also, if the alert has a "remember this action" or "create a rule for this" selection, select it. This is how the firewall learns what can be trusted on your network.
- Do not have more than one firewall enabled at the same time on your computer. An example would be having both the Windows firewall provided by the operating system and a 3rd party firewall enabled at the same time. Having more than one firewall enabled at the same time will not make your computer any safer and may cause problems.

For more information about using your printer with personal firewall software, visit www.hp.com/go/wirelessprinting, and then click **Firewall Help** in the **Need Help Troubleshooting?** section. The Firewall Help section also includes workarounds for known issues with some firewalls.

 **NOTE:** At this time, some portions of this site are not available in all languages.

Solve printer management problems

 **TIP:** You can visit the HP online support website at www.hp.com/support for information and utilities that can help you correct many common printer problems.

This section provides solutions to common problems that involve managing the printer. This section contains the following topic:

- [Embedded web server cannot be opened](#)

 **NOTE:** To use the embedded EWS, the printer must be connected to a network using either an Ethernet or a wireless connection. You cannot use the embedded web server if the printer is connected to a computer with a USB cable.

Embedded web server cannot be opened

Check your network setup

- Make sure you are not using a phone cord or a crossover cable to connect the printer to the network.
- Make sure the network cable is securely connected to the printer.
- Make sure the network hub, switch, or router is turned on and working correctly.

Check the computer

Make sure the computer that you are using is connected to the network.



NOTE: To use the EWS, the printer must be connected to a network using either an Ethernet or a wireless connection. You cannot use the embedded web server if the printer is connected to a computer with a USB cable.

Check your web browser

- Make sure the web browser meets the minimum system requirements. For more information, see [Embedded web server specifications](#).
- If your web browser uses any proxy settings to connect to the Internet, try turning off these settings. For more information, see the documentation available with your web browser.
- Make sure JavaScript and cookies are enabled in your web browser. For more information, see the documentation available with your web browser.

Check the printer IP address

- To check the IP address of the printer, obtain the IP address by printing a network configuration page. Touch  (right arrow), select **Setup**, select **Network**, and then select **Print Network Settings**.
- Ping the printer using the IP address from the command prompt (Windows) or from Network Utility (Mac OS X). (Network Utility is located in the **Utilities** folder in the **Applications** folder at the top level of the hard disk.)

For example, if the IP address is 123.123.123.123, type the following at the command prompt (Windows):

```
C:\Ping 123.123.123.123
```

– Or –

In Network Utility (Mac OS X), click the **Ping** tab, type the 123.123.123.123 in the box, and then click **Ping**.

If a reply appears, the IP address is correct. If a time-out response appears, the IP address is incorrect.

Troubleshoot installation issues



TIP: You can visit the HP online support website at www.hp.com/support for information and utilities that can help you correct many common printer problems.

- [Hardware installation suggestions](#)
- [HP software installation suggestions](#)

Hardware installation suggestions

Check the printer

- Make sure that all packing tape and material have been removed from outside and inside the printer.
- Make sure that the printer is loaded with paper.
- Make sure that no lights are on or blinking except the Ready light, which should be on. If the Attention light is blinking, check for messages on the printer control panel.

Check the hardware connections

- Make sure that any cords and cables that you are using are in good working order.
- Make sure that the power cord is connected securely to both the printer and to a working power outlet.

Check the printhead and ink cartridges

- Make sure that all of the printhead and ink cartridges are firmly installed in their correct, color-coded slot. The printer cannot work if they are not all installed.
- Make sure that the printhead latch is closed correctly.

HP software installation suggestions

Check the computer system

- Make sure that your computer is running one of the supported operating systems. For more information, see [System requirements](#).
- Make sure that the computer meets at least the minimum system requirements. For more information, see [System requirements](#).
- In the Windows Device Manager, make sure that the USB drivers have not been disabled.
- If you are using a computer running Windows, and the computer cannot detect the printer, run the Uninstall utility (located in the printer's subfolder within the HP folder) to perform a complete uninstallation of the printer driver. Restart your computer, and reinstall the printer driver.

Verify installation preliminaries

- Make sure to use the installation CD that contains the correct HP software for your operating system.
- Before installing HP software, make sure that all other programs are closed.
- If the computer does not recognize the path to the CD-ROM drive that you type, make sure that you are specifying the correct drive letter.
- If the computer cannot recognize the installation CD in the CD-ROM drive, inspect the installation CD for damage. You can download the printer driver from the HP website (www.hp.com/support).

 **NOTE:** After correcting any problems, run the installation program again.

Solve network problems

General network troubleshooting



- If you are unable to install the HP software, verify that:
 - All cable connections to the computer and the printer are secure.
 - The network is operational and the network hub, switch, or router is turned on.
 - All applications, including virus protection programs, spyware protection programs, and firewalls, are closed or disabled for computers running Windows.

- Make sure the printer is installed on the same subnet as the computers that use the printer.
- If the installation program cannot discover the printer, print the network configuration page and enter the IP address manually in the installation program. For more information, see [Understand the network configuration page](#).
- If you installed the printer driver using the Add Printer wizard and specified the TCP/IP port, make sure that the network ports created in the printer driver match the printer IP address:
 - Print the printer's network configuration page. For more information, see [Understand the network configuration page](#).
 - Click **Start**, and then click **Printers** or **Printers and Faxes** or **Devices and Printers**.
 - Or -
 - Click **Start**, click **Control Panel**, and then double-click **Printers**.
 - Right-click the printer icon, click **Properties**, and then click the **Ports** tab.
 - Select the TCP/IP port for the printer, and then click **Configure Port**.
 - Compare the IP address listed in the dialog box and make sure it matches the IP address listed on the network configuration page. If the IP addresses are different, change the IP address in the dialog box to match the address on the network configuration page.
 - Click **OK** twice to save the settings and close the dialog boxes.

Problems connecting to an Ethernet network

- If the **Link** light on the network connector does not turn on, make sure that all of the "General network troubleshooting" conditions are met.
- Though it is not recommended that you assign the printer with a static IP address, you might resolve some installation problems (such as a conflict with a personal firewall) by doing so.

To reset the printer's network settings

1. Touch  (right arrow), touch **Setup**, and then touch **Network**. Touch **Restore Network Defaults**, and then select **Yes**. A message appears stating that the network defaults have been restored.
2. Touch  (right arrow), touch **Setup**, select **Reports**, and then select **Print Network Configuration Page** to print the network configuration page and verify that the network settings have been reset.

Understand the Printer Status Report

Use the printer status report to view current printer information and ink cartridge status. Also use the printer status report to help you troubleshoot problems with the printer.

The printer status report also contains a log of recent events.

If you need to call HP, it is often useful to print the printer status report before calling.

Printer Status Report

PRINTER INFORMATION





1. Model Name: HP ColorJet Pro 225da Printer	11. Firmware Version: 01.00.02.01
2. Serial Number: C1B86160182823	12. Active Connection Type: None
3. Product Number: CV105A	13. IP or Hostname: 192.168.1.100
4. Serial ID: 02116	14. Address: 192.168.1.100
5. Printer Zone (PZ): 0	15. Address Password: M3 Set
6. Firmware Version: EN12CA020408	
7. Full Name: HP ColorJet Pro 225da Printer	
8. Country/Region: US F1	
9. Duplicate: not set	

Print Usage Information





11. Total Pages Printed: 974
12. Total Pages Printed by Tray: 0
13. Total Pages Printed by Accessory: 21

Ink Delivery System Information

25. Ink Level:

	High	Medium	Low	Critical
				

26. Estimated Ink Level:

				
--	---	---	---	---

27. Ink System:

HP 8814L	HP 8815L	HP 8816L	HP 8817L
30.00000	28.12500	28.12500	28.12500
30.00000	28.12500	28.12500	28.12500
1	1	1	1
0	0	0	0
0	0	0	0
OK	OK	OK	OK
HP 8814L	HP 8815L	HP 8816L	HP 8817L
HP 8814	HP 8815	HP 8816	HP 8817

**Not all cartridges are available in all regions.

Print Head Information

28. Print Head: C0000000 00000000 00000000 00000000 45454545

29. Print Head Status: OK

30. Ink: OK

Additional Assistance

For more information about how to change settings and troubleshoot problems, see the user documentation for your device. This documentation is available on your computer after you install the software—either the HP HP ColorJet Pro 225da Printer Printer Software or the HP ePrint and Scan Software.

Wireless Network Test

You may need to be connected to a wireless network to run the Wireless Network Test. You can access the test by touching the **Test** icon.

- 1. **Printer Information:** Shows printer information (such as the printer name, model number, serial number, and firmware version number), the accessories that are installed (such as the automatic two-sided printing accessory or duplexer), and the number of pages printed from the trays and accessories.
- 2. **Ink Delivery System Information:** Shows the estimated ink levels (represented in graphical form as gauges) and the part numbers and warranty expiration dates for the ink cartridges.

 **NOTE:** Ink level warnings and indicators provide estimates for planning purposes only. When you receive a low-ink warning message, consider having a replacement cartridge available to avoid possible printing delays. You do not need to replace cartridges until prompted to do so.

- 3. **Additional Assistance:** Provides information about where you can go to get more information about the printer, as well as information about how to set up a Fax Text and how to run a Print Wireless Network Test.

To print the Printer Status Report

From the Home screen, touch  (right arrow), and then select **Setup**. Touch **Reports**, and then select **Printer Status Report**.

Printhead maintenance

If you are experiencing problems with printing, you might have a problem with the printhead. You should perform the procedures in the following sections only when directed to do so for resolving print quality issues.

Performing the aligning and cleaning procedures unnecessarily can waste ink and shorten the life of the cartridges.

This section contains the following topics:

- [Clean the printhead](#)
- [Calibrate the linefeed](#)
- [Align the printhead](#)
- [Reinstall the printhead](#)

Clean the printhead

If your printed output is streaked or has any incorrect or missing colors, the printhead might need to be cleaned.

There are three stages of cleaning. Each stage lasts about two minutes, uses one sheet of paper, and uses an increasing amount of ink. After each stage, review the quality of the printed page. You should only initiate the next phase of cleaning if the print quality is poor.

If print quality still seems poor after you complete both stages of cleaning, try aligning the printer. If print quality problems persist after cleaning and aligning, contact HP support. For more information, see [HP support](#).

 **NOTE:** Cleaning uses ink, so clean the printhead only when necessary. The cleaning process takes a few minutes. Some noise might be generated in the process. Before cleaning the printhead, make sure you load paper. For more information, see [Load paper](#).

Not turning the printer off correctly can cause print quality problems. For more information, see [Turn the printer off](#).

To clean the printhead from the control panel

1. Load Letter, A4, or Legal unused plain white paper into the main input tray.
2. Touch , and then select **Setup**.
3. Touch **Tools**, and then select **Clean Printhead**.

To clean the printhead from Toolbox (Windows)

1. Open Toolbox. For more information, see [Open the Toolbox](#).
2. From the **Device Services** tab, click the icon to the left of **Clean Printheads**.
3. Follow the on-screen instructions.

To clean the printhead from HP Utility (Mac OS X)

1. Open HP Utility. For more information, see [HP Utility \(Mac OS X\)](#).
2. In the **Information And Support** section, click **Clean Printheads**.
3. Click **Clean**, and then follow the on-screen instructions.

To clean the printhead from the embedded web server (EWS)

1. Open the EWS. For more information, see [To open the embedded web server](#).
2. Click the **Tools** tab, and then click **Print Quality Toolbox** in the **Utilities** section.
3. Click **Clean Printhead** and follow the on-screen instructions.

Calibrate the linefeed

The printer automatically aligns the printhead during the initial setup.

You might want to use this feature when the printer status page shows streaking or white lines through any of the blocks of color or if you are having print quality issues with your printouts.

To calibrate the linefeed from the control panel

1. Load Letter, A4, or Legal unused plain white paper into the main input tray.
2. On the printer control panel, touch  (right arrow), and then touch **Setup**.
3. Touch **Tools**, and then select **Calibrate Linefeed**.

To calibrate the linefeed from Toolbox (Windows)

1. Open Toolbox. For more information, see [Open the Toolbox](#).
2. From the **Device Services** tab, click the icon to the left of **Linefeed Calibration**.
3. Follow the on-screen instructions.

To calibrate the linefeed from the embedded web server (EWS)

1. Open the EWS. For more information, see [To open the embedded web server](#).
2. Click the **Tools** tab, and then click **Print Quality Toolbox** in the **Utilities** section.
3. Click **Calibrate Linefeed** and follow the on-screen instructions.

Align the printhead

The printer automatically aligns the printhead during the initial setup.

You might want to use this feature when the printer status page shows streaking or white lines through any of the blocks of color or if you are having print quality issues with your printouts.

To align the printhead from the control panel

1. Load Letter, A4, or Legal unused plain white paper into the main input tray.
2. On the printer control panel, touch  (right arrow), and then touch **Setup**.
3. Touch **Tools**, and then select **Align Printhead**.

To align the printhead from Toolbox (Windows)

1. Open Toolbox. For more information, see [Open the Toolbox](#).
2. From the **Device Services** tab, click the icon to the left of **Align Printheads**.
3. Follow the on-screen instructions.

To align the printhead from HP Utility (Mac OS X)

1. Open HP Utility. For more information, see [HP Utility \(Mac OS X\)](#).
2. In the **Information And Support** section, click **Align Printhead**.
3. Click **Align**, and then follow the on-screen instructions.

To align the printhead from the embedded web server (EWS)

1. Open the EWS. For more information, see [To open the embedded web server](#).
2. Click the **Tools** tab, and then click **Print Quality Toolbox** in the **Utilities** section.
3. Click **Align Printer** and follow the on-screen instructions.

Reinstall the printhead

 **NOTE:** This procedure should only be performed when a **Missing or Failed Printhead** message has been seen and the printer has first been turned off and then back on to try to resolve the message. If the message persists, try this procedure.

To reinstall the printhead

1. Make sure that the printer is turned on.
2. Open the ink cartridge access door.

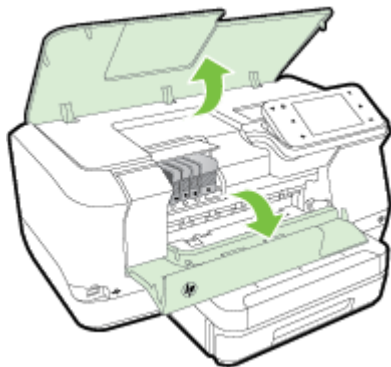

3. Lift the latch handle on the print carriage.

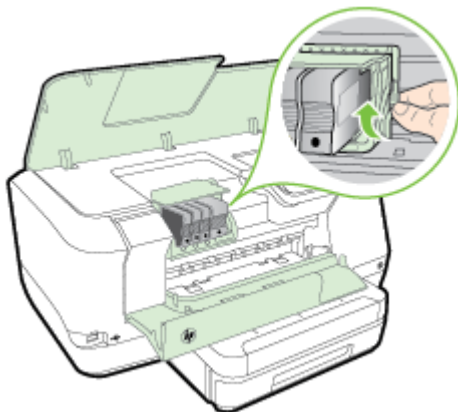

4. Remove the printhead by lifting it up and then pulling it out of the printer.

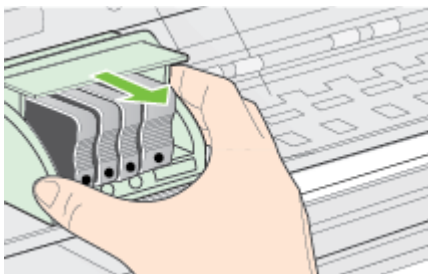

5. Make sure the latch handle is raised, and then reinsert the printhead.

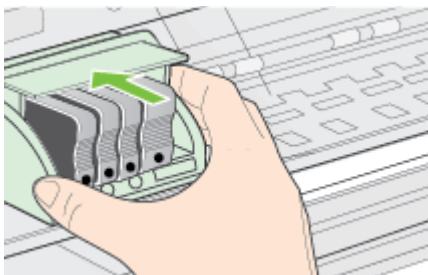

6. Carefully lower the latch handle.



NOTE: Make sure you lower the latch handle before reinserting the ink cartridges. Leaving the latch handle raised can result in incorrectly seated ink cartridges and problems printing. The latch must remain down in order to correctly install the ink cartridges.

7. Close the ink cartridge access door.

Understand the network configuration page

If the printer is connected to a network, you can print a network configuration page to view the network settings for the printer. You can use the network configuration page to help troubleshoot network connectivity problems. If you need to call HP, it is often useful to print this page before calling.

HP Network Configuration Page	
1	General Information Network Status: Offline Active Connection Type: None URL(s) for Embedded Web Server: http://0.0.0.0 Firmware Revision: EVLJCA1224BR Hardware: HP7749800 Serial Number: CH18M 810408RZ Internet: Not applicable
	802.11 Wired Hardware Address (MAC): 02:ba:d0:a4:49:83 Link Configuration: None
	802.11 Wireless Hardware Address (MAC): 02:ba:d0:9c:2c:54 Status: Disabled Communication Mode: Infrastructure Network Name (SSID): Not Set
	Wireless Direct Status: Off Hardware Address (MAC): 02:ba:d0:0e:90:1a
	Port 9100 Status: Enabled
	LPD Status: Enabled
	Bonjour Status: Enabled Service Name: HP Officejet Po 2514w Printer (A44923)
SLP Status: Enabled	

4

Microsoft Web Services	
WS Discover	Enabled
WS Print	Enabled
<hr/>	
snmp	
Status	Read-write/enable
SNMP Version	v1
Set Community Name	Not Specified
Get Community Name	Not Specified
<hr/>	
IPP	
Status	Enabled

- 1. General Information:** Shows information about the current status and active connection type of the network, and other information, such as the URL of the embedded web server.
- 2. 802.3 Wired:** Shows information about the active Ethernet network connection, such as the IP address, subnet mask, default gateway, as well as the hardware address of the printer.
- 3. 802.11 Wireless (some models):** Shows information about your wireless network connection, such as the hostname, IP address, subnet mask, default gateway, and server.
- 4. Miscellaneous:** Shows information about more advanced network settings.
 - Port 9100:** The printer supports raw IP printing through TCP Port 9100. This HP-proprietary TCP/IP port on the printer is the default port for printing. It is accessed by HP software (for example, the HP Standard Port).
 - LPD:** Line Printer Daemon (LPD) refers to the protocol and programs associated with line-printer spooling services that may be installed on various TCP/IP systems.



NOTE: The LPD functionality can be used with any host implementation of LPD that complies with the RFC 1179 document. The process for configuring printer spoolers, however, might differ. See your system documentation for information about configuring these systems.

- Bonjour:** Bonjour services (which use mDNS, or Multicast Domain Name System) are typically used on small networks for IP address and name resolution (through UDP port 5353), where a conventional DNS server is not used.
- SLP:** Service Location Protocol (SLP) is an Internet standard network protocol that provides a framework to allow networking applications to discover the existence, location, and configuration of networked services in enterprise networks. This protocol simplifies discovery and use of network resources such as printers, web servers, fax machines, video cameras, files systems, backup devices (tape drives), databases, directories, mail servers, calendars.

- **Microsoft Web Services:** Enable or disable the Microsoft Web Services Dynamic Discovery (WS Discovery) protocols or Microsoft Web Services for Devices (WSD) Print services supported on the printer. Disable unused print services to prevent access through those services.



NOTE: For more information about WS Discovery and WSD Print, visit www.microsoft.com.

- **SNMP:** SNMP (Simple Network Management Protocol) is used by network management applications for device management. The printer supports SNMPv1 protocol on IP networks.
 - **WINS:** If you have a Dynamic Host Configuration Protocol (DHCP) server on your network, the printer automatically obtains its IP address from that server and registers its name with any RFC 1001 and 1002-compliant dynamic name services as long as a WINS server IP address has been specified.
- 5. Connected PC(s):** Lists the computers connected to this printer, as well as the last time these computers accessed the printer.

To print the network configuration page from the printer control panel

From the Home screen, touch  (right arrow), and then select **Setup**. Touch **Reports**, and then select **Network Configuration Page**.

Clear jams

Occasionally, media becomes jammed during a job.

This section contains the following topics:

- [Clear paper jams](#)
- [Avoid paper jams](#)

Clear paper jams

Paper jams can occur either inside the printer or in the automatic document feeder.

 **CAUTION:** To prevent possible damage to the printhead, clear paper jams as soon as possible.

 **TIP:** If you notice poor print quality, clean the printhead. For more information, see [Clean the printhead](#).

Use these steps to clear a paper jam.

To clear a jam inside the printer

1. Remove all media from the output tray.

⚠ CAUTION: Trying to clear a paper jam from the front of the printer can damage the print mechanism. Always access and clear paper jams through the automatic two-sided printing accessory (duplexer).

2. Check the duplexer.

- a. Push the button on either side of the duplexer, and then remove the unit.

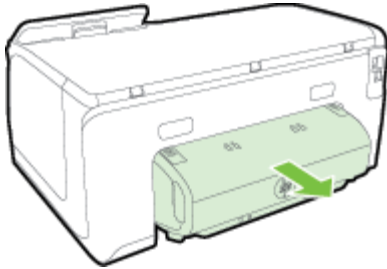

- b. Locate any jammed media inside the printer, grasp it with both hands and then pull it towards you.
- c. If the jam is not there, push the latch on top of the duplexer and lower the cover. If media is jammed inside, carefully remove it. Close the cover.

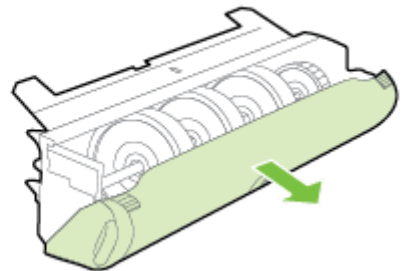
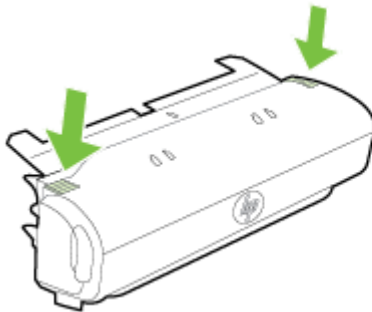

- d. Reinsert the duplexer into the printer.
3. Open the top cover and remove any debris.
 4. If you have not found the jam and have Tray 2 installed, pull out the tray and remove the jammed media, if possible. If not, do the following:
 - a. Ensure the printer is turned off and disconnect the power cord.
 - b. Lift the printer off Tray 2.
 - c. Remove the jammed media from the bottom of the printer or from Tray 2.
 - d. Reposition the printer on top of Tray 2.

5. Open the ink cartridge access door. If there is paper remaining inside the printer, ensure the carriage has moved to the right of the printer, free any paper scraps or wrinkled media, and pull the media towards you through the top of the printer.

⚠ WARNING! Do not reach into the printer when it is on and the carriage is stuck. When you open the ink cartridge access door, the carriage should return to its position on the right side of the printer. If it does not move to the right, turn off the printer before you remove any jam.

6. After clearing the jam, close all covers, turn on the printer (if you turned it off) and resend the print job.

Avoid paper jams

To help avoid paper jams, follow these guidelines.

- Remove printed papers from the output tray frequently.
- Make sure that you are printing with media that is not wrinkled, folded, or damaged.
- Prevent curled or wrinkled paper by storing all unused paper flat in a resealable bag.
- Do not use paper that is too thick or too thin for the printer.
- Make sure that the trays are loaded correctly and are not too full. For more information, see [Load paper](#).
- Ensure that paper loaded in the input tray lays flat and the edges are not bent or torn.
- Do not place too much paper in the document feeder tray. For information on the maximum number of sheets allowed in the automatic document feeder, see [Paper specifications](#).
- Do not combine different paper types and paper sizes in the input tray; the entire stack of paper in the input tray must be the same size and type.
- Adjust the paper-width guide in the input tray to fit snugly against all paper. Make sure the paper-width guide does not bend the paper in the input tray.
- Do not force paper too far forward in the input tray.
- Use paper types that are recommended for the printer. For more information, see [Paper specifications](#).
- If the printer is about to run out of paper, allow the printer to run out of paper first and then add paper. Do not try to add paper while the printer is trying to pick up a sheet.
- If you are printing on both sides of a page, do not print highly saturated images on light weight paper.
- Make sure that the printer is clean. For more information, see [Maintain the printer](#).

A Technical information

This section contains the following topics:

- [Warranty information](#)
- [Printer specifications](#)
- [Regulatory information](#)
- [Environmental product stewardship program](#)
- [Third-party licenses](#)

Warranty information

This section contains the following topics:

- [Hewlett-Packard limited warranty statement](#)
- [Ink cartridge warranty information](#)

Hewlett-Packard limited warranty statement

HP product	Duration of limited warranty
Software Media	90 days
Printer	1 year
Print or Ink cartridges	Until the HP Ink is depleted or the "end of warranty" date printed on the cartridge has been reached, whichever occurs first. This warranty does not cover HP Ink products that have been refilled, remanufactured, refurbished, misused, or tampered with.
Printheads (only applies to products with customer replaceable printheads)	1 year
Accessories	1 year unless otherwise stated

A. Extent of limited warranty

- Hewlett-Packard (HP) warrants to the end-user customer that the HP products specified above will be free from defects in materials and workmanship for the duration specified above, which duration begins on the date of purchase by the customer.
- For software products, HP's limited warranty applies only to a failure to execute programming instructions. HP does not warrant that the operation of any product will be interrupted or error free.
- HP's limited warranty covers only those defects that arise as a result of normal use of the product, and does not cover any other problems, including those that arise as a result of:
 - Improper maintenance or modification;
 - Software, media, parts, or supplies not provided or supported by HP;
 - Operation outside the product's specifications;
 - Unauthorized modification or misuse.
- For HP printer products, the use of a non-HP cartridge or a refilled cartridge does not affect either the warranty to the customer or any HP support contract with the customer. However, if printer failure or damage is attributable to the use of a non-HP or refilled cartridge or an expired ink cartridge, HP will charge its standard time and materials charges to service the printer for the particular failure or damage.
- If HP receives, during the applicable warranty period, notice of a defect in any product which is covered by HP's warranty, HP shall either repair or replace the product, at HP's option.
- If HP is unable to repair or replace, as applicable, a defective product which is covered by HP's warranty, HP shall, within a reasonable time after being notified of the defect, refund the purchase price for the product.
- HP shall have no obligation to repair, replace, or refund until the customer returns the defective product to HP.
- Any replacement product may be either new or like-new, provided that it has functionality at least equal to that of the product being replaced.
- HP products may contain remanufactured parts, components, or materials equivalent to new in performance.
- HP's Limited Warranty Statement is valid in any country where the covered HP product is distributed by HP. Contracts for additional warranty services, such as on-site service, may be available from any authorized HP service facility in countries where the product is distributed by HP or by an authorized importer.

B. Limitations of warranty

TO THE EXTENT ALLOWED BY LOCAL LAW, NEITHER HP NOR ITS THIRD PARTY SUPPLIERS MAKES ANY OTHER WARRANTY OR CONDITION OF ANY KIND, WHETHER EXPRESS OR IMPLIED WARRANTIES OR CONDITIONS OF MERCHANTABILITY, SATISFACTORY QUALITY, AND FITNESS FOR A PARTICULAR PURPOSE.

C. Limitations of liability

- To the extent allowed by local law, the remedies provided in this Warranty Statement are the customer's sole and exclusive remedies.
- TO THE EXTENT ALLOWED BY LOCAL LAW, EXCEPT FOR THE OBLIGATIONS SPECIFICALLY SET FORTH IN THIS WARRANTY STATEMENT, IN NO EVENT SHALL HP OR ITS THIRD PARTY SUPPLIERS BE LIABLE FOR DIRECT, INDIRECT, SPECIAL, INCIDENTAL, OR CONSEQUENTIAL DAMAGES, WHETHER BASED ON CONTRACT, TORT, OR ANY OTHER LEGAL THEORY AND WHETHER ADVISED OF THE POSSIBILITY OF SUCH DAMAGES.

D. Local law

- This Warranty Statement gives the customer specific legal rights. The customer may also have other rights which vary from state to state in the United States, from province to province in Canada, and from country to country elsewhere in the world.
- To the extent that this Warranty Statement is inconsistent with local law, this Warranty Statement shall be deemed modified to be consistent with such local law. Under such local law, certain disclaimers and limitations of this Warranty Statement may not apply to the customer. For example, some states in the United States, as well as some governments outside the United States (including provinces in Canada), may:
 - Preclude the disclaimers and limitations in this Warranty Statement from limiting the statutory rights of a consumer (e.g., the United Kingdom);
 - Otherwise restrict the ability of a manufacturer to enforce such disclaimers or limitations; or
 - Grant the customer additional warranty rights, specify the duration of implied warranties which the manufacturer cannot disclaim, or allow limitations on the duration of implied warranties.
- THE TERMS IN THIS WARRANTY STATEMENT, EXCEPT TO THE EXTENT LAWFULLY PERMITTED, DO NOT EXCLUDE, RESTRICT, OR MODIFY, AND ARE IN ADDITION TO, THE MANDATORY STATUTORY RIGHTS APPLICABLE TO THE SALE OF THE HP PRODUCTS TO SUCH CUSTOMERS.

HP Limited Warranty

The name and address of the HP entity responsible for the performance of the HP Limited Warranty in your country is as follows:

United Kingdom: Hewlett-Packard Ltd Cain Road Bracknell GB-Berks RG12 1HN

Ireland: Hewlett-Packard Ireland Limited, 63-74 Sir John Rogerson's Quay, Dublin 2

Malta: Hewlett-Packard International Trade B.V. Malta Branch, 48, Amery Street, Sliema SLM 1701, MALTA

You may have additional statutory rights against the seller based on your purchase agreement. Those rights are not in any way affected by this HP Limited Warranty.

Ink cartridge warranty information

The HP cartridge warranty is applicable when the product is used in its designated HP printer. This warranty does not cover HP ink products that have been refilled, remanufactured, refurbished, misused, or tampered with.

During the warranty period the product is covered as long as the HP ink is not depleted and the end of warranty date has not been reached. The end of warranty date, in YYYY-MM format, may be found on the product as indicated:

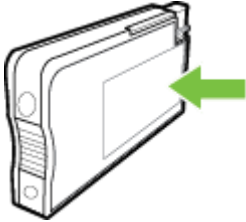

Printer specifications

This section contains the following topics:

- [Physical specifications](#)
- [Product features and capacities](#)
- [Processor and memory specifications](#)
- [System requirements](#)
- [Network protocol specifications](#)
- [Embedded web server specifications](#)
- [Paper specifications](#)
- [Print specifications](#)
- [Web Services specifications](#)
- [HP website specifications](#)
- [Environmental specifications](#)
- [Electrical specifications](#)
- [Acoustic emission specifications](#)
- [Memory device specifications](#)

Physical specifications

Printer size (width x height x depth)

- 494 x 238 x 460 mm (19.5 x 9.4 x 18.1 inches)
- **With Tray 2:** Adds 82 mm (3.2 inches) to the height of the printer

Printer weight

The printer weight does not include printing supplies or Tray 2.

- 8.58 kg (17.9 lb)
- **With Tray 2:** Adds 2.8 kg (6.2 lb)

Product features and capacities

Feature	Capacity
Connectivity	<ul style="list-style-type: none"> • USB 2.0-compliant high speed • USB 3.0-compliant high speed • USB 2.0 high-speed host port • Wireless 802.11b/g/n* • 802.3 network (Ethernet)
Print method	Drop-on-demand thermal inkjet printing
Ink cartridges	<p>Four ink cartridges (one each for black, cyan, magenta, and yellow)</p> <p>NOTE: Not all ink cartridges are supported in all countries/regions.</p>
Printheads	One printhead
Supply yields	For more information on estimated ink cartridge yields, visit www.hp.com/go/learnaboutsupplies/ .
Printer languages	HP PCL 5, HP PCL 6, PS3, and PDF 5.

(continued)

Feature	Capacity
Font support	US fonts: CG Times, CG Times Italic, Universe, Universe Italic, Courier, Courier Italic, Letter Gothic, Letter Gothic Italic.
Duty cycle	Up to 25,000 pages per month
Printer control panel language support Language availability varies by country/region.	Arabic, Bulgarian, Croatian, Czech, Danish, Dutch, English, Finnish, French, German, Greek, Hebrew, Hungarian, Italian, Japanese, Korean, Norwegian, Polish, Portuguese, Romanian, Russian, Simplified Chinese, Slovak, Slovenian, Spanish, Swedish, Traditional Chinese, Turkish.

* The printer supports the 802.11n 2.4 GHz frequency band.

Processor and memory specifications

Printer processor

528 MHz processor dual core

Printer memory

512 MB built-in RAM, 128 MB Flash

System requirements

Software and system requirements are located in the Readme file.



NOTE: For the most current information about supported operating systems and system requirements, visit www.hp.com/support.

Network protocol specifications

Network protocol specifications are located in the Readme file.



NOTE: For the most current information about supported operating systems and system requirements, visit www.hp.com/support.

Embedded web server specifications

Requirements

- A TCP/IP-based network (IPX/SPX-based networks are not supported)
- A web browser (either Microsoft Internet Explorer 7.0 or higher, Mozilla Firefox 3.0 or higher, Safari 3.0 or higher, or Google Chrome 5.0 or higher)
- A network connection (you cannot use the embedded web server connected directly to a computer with a USB cable)
- An Internet connection (required for some features)



NOTE: You can open the embedded web server without being connected to the Internet. However, some features are not available.

NOTE: The embedded web server must be on the same side of a firewall as the printer.

Paper specifications

Use these tables to determine the correct media to use with your printer, and determine what features work with your media.

- [Understand specifications for supported paper](#)
- [Set minimum margins](#)
- [Guidelines for printing on both sides of a page](#)

Understand specifications for supported paper

Use the tables to determine the correct media to use with your printer, and to determine what features work with your media.

- [Understand supported sizes](#)
- [Understand supported paper types and weights](#)

Understand supported sizes

 **NOTE:** Tray 2 is available as an option.

Media size	Tray 1	Tray 2	Duplexer
Standard media sizes			
10x15cm	✓		
2L	✓		
U.S. Letter (216 x 279 mm; 8.5 x 11 inches)*	✓	✓	✓
8.5 x 13 inches (216 x 330 mm)	✓		
U.S. Legal (216 x 356 mm; 8.5 x 14 inches)	✓	✓	
A4 (210 x 297 mm; 8.3 x 11.7 inches)*	✓	✓	✓
U.S. Executive (184 x 267 mm; 7.25 x 10.5 inches)	✓		✓
U.S. Statement (140 x 216 mm; 5.5 x 8.5 inches)	✓		
B5 (JIS) (182 x 257 mm; 7.17 x 10.12 inches)	✓		✓
A5 (148 x 210 mm; 5.8 x 8.3 inches)*	✓		(From Tray 1 only) ✓
6 x 8 inches	✓		
Edge-to-Edge A4*	✓		✓
Edge-to-Edge Letter*	✓		✓
Envelopes			

(continued)

Media size	Tray 1	Tray 2	Duplexer
U.S. #10 Envelope (105 x 241 mm; 4.12 x 9.5 inches)	✓		
Monarch Envelope (98 x 191 mm; 3.88 x 7.5 inches)	✓		
Card Envelope (111 x 152 mm; 4.4 x 6 inches)	✓		
A2 Envelope (111 x 146 mm; 4.37 x 5.75 inches)	✓		
DL Envelope (110 x 220 mm; 4.3 x 8.7 inches)	✓		
C5 Envelope (162 x 229 mm; 6.4 x 9 inches)	✓		
C6 Envelope (114 x 162 mm; 4.5 x 6.4 inches)	✓		
Japanese Envelope Chou #3 (120 x 235 mm; 4.7 x 9.3 inches)	✓		
Japanese Envelope Chou #4 (90 x 205 mm; 3.5 x 8.1 inches)	✓		
Cards			
Index card (76.2 x 127 mm; 3 x 5 inches)	✓		
Index card (102 x 152 mm; 4 x 6 inches)	✓		
Index card (127 x 203 mm; 5 x 8 inches)	✓		
A6 card (105 x 148.5 mm; 4.13 x 5.83 inches)	✓		
A4 index card (210 x 297 mm; 8.3 x 11.7 inches)	✓		
Hagaki (100 x 148 mm; 3.9 x 5.8 inches) **	✓		
Ofuku Hagaki** (200 x 148 mm; 7.8 x 5.8 inches)	✓		
Index Card Letter (216 x 279 mm; 8.5 x 11 inches)	✓		
Photo media			
Photo media (76.2 x 127 mm; 3 x 5 inches)	✓		
Photo media (102 x 152 mm; 4 x 6 inches)	✓		
Photo media (5 x 7 inches)	✓		

(continued)

Media size	Tray 1	Tray 2	Duplexer
Photo media (8 x 10 inches)	✓		
Photo media (8.5 x 11 inches)	✓		
Photo L (89 x 127 mm; 3.5 x 5 inches)	✓		
Photo 2L (127 x 178 mm)	✓		
13 x 18 cm	✓		
Other media NOTE: Defining custom-size paper sizes is only available in the HP printing software in Mac OS X.			
Custom-size paper between 76.2 to 216 mm wide and 127 to 356 mm long (3 to 8.5 inches wide and 5 to 14 inches long)	✓		

* These sizes can be used for edge-to-edge printing.

** The printer is compatible with plain and inkjet hagaki from Japan Post only. It is not compatible with photo hagaki from Japan Post.

Understand supported paper types and weights

Tray	Type	Weight	Capacity
Tray 1	Paper	60 to 105 g/m ² (16 to 28 lb bond)	Up to 250 sheets of plain paper (25 mm or 1 inch stacked)
	Photo media	280 g/m ² (75 lb bond)	Up to 100 sheets (17 mm or 0.67 inch stacked)
	Labels		Up to 100 sheets (17 mm or 0.67 inch stacked)
	Envelopes	75 to 90 g/m ² (20 to 24 lb bond envelope)	Up to 30 sheets (17 mm or 0.67 inch stacked)
	Cards	Up to 200 g/m ² (110 lb index)	Up to 80 cards
Tray 2	Plain paper only	60 to 105 g/m ² (16 to 28 lb bond)	Up to 250 sheets of plain paper (25 mm or 1.0 inch stacked)
Duplexer	Plain and brochure	60 to 105 g/m ²	Not applicable

(continued)

Tray	Type	Weight	Capacity
		(16 to 28 lb bond)	
Output tray	All supported media		Up to 150 sheets of plain paper (text printing)

Set minimum margins

The document margins must match (or exceed) these margin settings in portrait orientation.

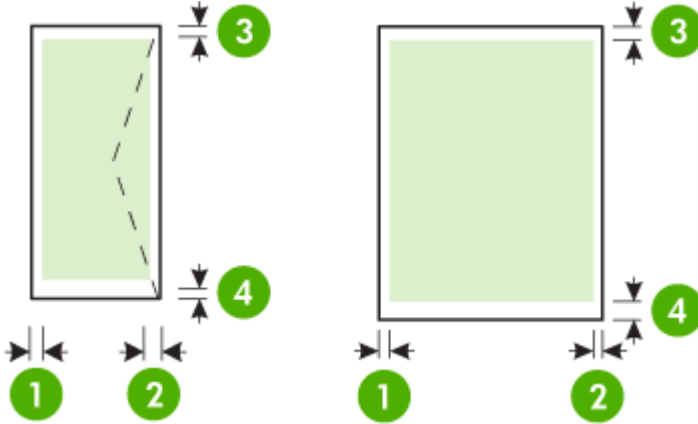

Media	(1) Left margin	(2) Right margin	(3) Top margin	(4) Bottom margin			
U.S. Letter	4 mm (0.16 inch)	4 mm (0.16 inch)	4 mm (0.16 inch)	4 mm (0.16 inch)			
U.S. Legal				Windows and 12mm (0.47 inch) Mac and Linux			
A4							
U.S. Executive							
U.S. Statement							
8.5 x 13 inch							
B5							
A5							
Cards							
Custom-size paper							
Photo paper							
Envelopes				4 mm (0.16 inch)	4 mm (0.16 inch)	16.5 mm (0.65 inch)	16.5 mm (0.65 inch)

Guidelines for printing on both sides of a page

- Always use media that conforms to the printer specifications. For more information, see [Paper specifications](#).
- Specify two-sided printing options in your application or in the printer driver.
- Do not print on both sides of envelopes, photo paper, glossy media, or paper lighter than 16 lb bond (60 g/m²) or heavier than 28 lb bond (105 g/m²). Jams might occur with these media types.

- Several kinds of media require a specific orientation when you print on both sides of a page. These include letterhead, preprinted paper, and paper with watermarks and prepunched holes. When you print from a computer running Windows, the printer prints the first side of the media first. Load the media with the print side facing down.
- For auto-duplexing, when printing finishes on one side of the media, the printer holds the media and pauses while the ink dries. Once the ink dries, the media is pulled back into the printer and the second side is printed. When printing is complete, the media is dropped onto the output tray. Do not grab it before printing is complete.

Print specifications

Black print resolution

1200 x 1200 optimized dpi on plain paper from 600 x 600 dpi input

Color print resolution

Up to 1200 x 1200 optimized dpi from 600 x 600 input dpi

Web Services specifications

An Internet connection using either a wired (Ethernet) or wireless connection.

HP ePrint

- Maximum size of email and attachments: 5 MB
- Maximum number of attachments: 10



NOTE: The printer's email address must be the only address listed in the "To" line of the email message.

Supported file types:

- PDF
- HTML
- Standard text file formats
- Microsoft Word, PowerPoint
- Image files, such as PNG, JPEG, TIFF, GIF, BMP



NOTE: You might be able to use other types of files with HP ePrint. However, HP cannot guarantee that they correct functionality with the printer because they have not been fully tested.

Printer Apps

To use certain Printer Apps, you might need to set up an account with a partner website. For more information, visit www.hpconnected.com.

HP website specifications

- A web browser (either Microsoft Internet Explorer 6.0 or higher, Mozilla Firefox 2.0 or higher, Safari 3.2.3 or higher, or Google Chrome 3.0) with the Adobe Flash plug-in (version 10 or higher).
- An Internet connection

Environmental specifications

Operating environment

Operating temperature: 5° to 40° C (41° to 104° F)

Operating humidity: 15 to 80% RH non-condensing

Recommended operating conditions: 15° to 32° C (59° to 90° F)

Recommended relative humidity: 25 to 75% RH non-condensing

Shipping environment

Maximum shipping temperature: -40° to 60° C (-40° to 140° F)

Maximum shipping humidity: 5 to 90% RH non-condensing

Electrical specifications

Power supply

Universal power adapter (internal)

Power requirements

Input voltage: 100 to 240 VAC, 50/60 Hz

Output voltage: +32V/+12V at 1095 mA/170 mA

Power consumption

34 watts printing (Fast Draft Mode)

Acoustic emission specifications

Print in Draft mode, noise levels per ISO 7779

HP Officejet Pro 251dw

- Sound pressure (bystander position)
LpAm 60 (dBA) (mono Draft print)
- Sound power
LwAd 6.7 (BA)

Memory device specifications

This section contains the following topics:

- [Memory card specifications](#)
- [USB flash drives](#)

Memory card specifications

Specifications

- Maximum recommended number of files on a memory card: 2,000
- Maximum recommended individual file size: 12 megapixel maximum, 10 MB maximum (TIFF files, 50 MB maximum)
- Maximum recommended memory card size: 64 GB (solid state only)



NOTE: Approaching any of the recommended maximums on a memory card might cause the performance of the printer to be slower than expected.

Supported memory card types

- Secure Digital (SD), Mini SD, Micro SD, SDXC
- High Capacity Secure Digital
- MultiMediaCard (MMC), MMC Plus, MMC (RS-MMC)

USB flash drives

HP has fully tested the following USB flash drives with the printer:

- **Kingston:** Data Traveler 100 USB 2.0 flash drive (4 GB, 8 GB, and 16 GB)
- **Lexar JumpDrive Traveller:** 1 GB
- **Imation:** 1 GB USB Swivel
- **SanDisk:** Cruzer Titanium plus USB Flash Drive 4 GB PN
- **HP:** 8 GB HI.SPEED USB flash drive v100w



NOTE: You might be able to use other USB flash drives with the printer. However, HP cannot guarantee that they correct functionality with the printer because they have not been fully tested.

Regulatory information

The printer meets product requirements from regulatory agencies in your country/region.

This section contains the following topics:

- [FCC statement](#)
- [Notice to users in Korea](#)
- [VCCI \(Class B\) compliance statement for users in Japan](#)
- [Notice to users in Japan about the power cord](#)
- [Noise emission statement for Germany](#)
- [European Union Regulatory Notice](#)
- [GS Declaration \(Germany\)](#)
- [Regulatory information for wireless products](#)
- [Regulatory model number](#)

FCC statement

FCC statement

The United States Federal Communications Commission (in 47 CFR 15.105) has specified that the following notice be brought to the attention of users of this product.

This equipment has been tested and found to comply with the limits for a Class B digital device, pursuant to Part 15 of the FCC Rules. These limits are designed to provide reasonable protection against harmful interference in a residential installation. This equipment generates, uses and can radiate radio frequency energy and, if not installed and used in accordance with the instructions, may cause harmful interference to radio communications. However, there is no guarantee that interference will not occur in a particular installation. If this equipment does cause harmful interference to radio or television reception, which can be determined by turning the equipment off and on, the user is encouraged to try to correct the interference by one or more of the following measures:

- Reorient or relocate the receiving antenna.
- Increase the separation between the equipment and the receiver.
- Connect the equipment into an outlet on a circuit different from that to which the receiver is connected.
- Consult the dealer or an experienced radio/TV technician for help.

For further information, contact:

Manager of Corporate Product Regulations
Hewlett-Packard Company
3000 Hanover Street
Palo Alto, Ca 94304
(650) 857-1501

Modifications (part 15.21)

The FCC requires the user to be notified that any changes or modifications made to this device that are not expressly approved by HP may void the user's authority to operate the equipment.

This device complies with Part 15 of the FCC Rules. Operation is subject to the following two conditions: (1) this device may not cause harmful interference, and (2) this device must accept any interference received, including interference that may cause undesired operation.

Notice to users in Korea

B 급 기기 (가정용 방송통신기기)	이 기기는 가정용(B급)으로 전자파적합등록을 한 기기로서 주로 가정에서 사용하는 것을 목적으로 하며, 모든 지역에서 사용할 수 있습니다.
------------------------	--

VCCI (Class B) compliance statement for users in Japan

この装置は、クラスB情報技術装置です。この装置は、家庭環境で使用することを目的としていますが、この装置がラジオやテレビジョン受信機に近接して使用されると、受信障害を引き起こすことがあります。取扱説明書に従って正しい取り扱いをして下さい。

VCCI-B

Notice to users in Japan about the power cord

製品には、同梱された電源コードをお使い下さい。
同梱された電源コードは、他の製品では使用出来ません。

Noise emission statement for Germany

Geräuschemission
LpA < 70 dB am Arbeitsplatz im Normalbetrieb nach DIN 45635 T. 19

European Union Regulatory Notice

Products bearing the CE marking comply with the following EU Directives:

- Low Voltage Directive 2006/95/EC
- EMC Directive 2004/108/EC
- Ecodesign Directive 2009/125/EC, where applicable



CE compliance of this product is valid if powered with the correct CE-marked AC adapter provided by HP.

If this product has wired and/or wireless telecommunications functionality, it also complies with the essential requirements of the following EU Directive:

R&TTE Directive 1999/5/EC

Compliance with these directives implies conformity to applicable harmonized European standards (European Norms) that are listed in the EU Declaration of Conformity issued by HP for this product or product family and available (in English only) either within the product documentation or at the following web site: www.hp.com/go/certificates (type the product number in the search field).

The compliance is indicated by one of the following conformity markings placed on the product:

	For non-telecommunications products and for EU harmonized telecommunications products, such as Bluetooth® within power class below 10mW.
	For EU non-harmonized telecommunications products (If applicable, a 4-digit notified body number is inserted between CE and !).

Please refer to the regulatory label provided on the product.

The telecommunications functionality of this product may be used in the following EU and EFTA countries: Austria, Belgium, Bulgaria, Cyprus, Czech Republic, Denmark, Estonia, Finland, France, Germany, Greece, Hungary, Iceland, Ireland, Italy, Latvia, Liechtenstein, Lithuania, Luxembourg, Malta, Netherlands, Norway, Poland, Portugal, Romania, Slovak Republic, Slovenia, Spain, Sweden, Switzerland, and United Kingdom.

The telephone connector (not available for all products) is intended for connection to analogue telephone networks.

Products with wireless LAN devices

Some countries may have specific obligations or special requirements about the operation of Wireless LAN networks such as indoor use only or restrictions of the channels available. Please make sure that the country settings of the wireless network are correct.

France

For 2.4-GHz Wireless LAN operation of this product, certain restrictions apply: This product may be used indoors for the entire 2400-MHz to 2483.5-MHz frequency band (channels 1 to 13). For outdoor use, only the 2400-MHz to 2454-MHz frequency band (channels 1 to 7) may be used. For the latest requirements, see www.arcep.fr.

The point of contact for regulatory matters is:

Hewlett-Packard GmbH, Dept./MS: HQ-TRE, Herrenberger Strasse 140, 71034 Boeblingen, GERMANY

GS Declaration (Germany)

GS-Erklärung (Deutschland)

Das Gerät ist nicht für die Benutzung im unmittelbaren Gesichtsfeld am Bildschirmarbeitsplatz vorgesehen. Um störende Reflexionen am Bildschirmarbeitsplatz zu vermeiden, darf dieses Produkt nicht im unmittelbaren Gesichtsfeld platziert werden.

Regulatory information for wireless products

This section contains the following regulatory information pertaining to wireless products:

- [Exposure to radio frequency radiation](#)
- [Notice to users in Brazil](#)
- [Notice to users in Canada](#)
- [Notice to users in Taiwan](#)
- [Notice to users in Mexico](#)
- [Notice to users in Japan](#)

Exposure to radio frequency radiation

Exposure to radio frequency radiation



Caution The radiated output power of this device is far below the FCC radio frequency exposure limits. Nevertheless, the device shall be used in such a manner that the potential for human contact during normal operation is minimized. This product and any attached external antenna, if supported, shall be placed in such a manner to minimize the potential for human contact during normal operation. In order to avoid the possibility of exceeding the FCC radio frequency exposure limits, human proximity to the antenna shall not be less than 20 cm (8 inches) during normal operation.

Notice to users in Brazil

Aviso aos usuários no Brasil

Este equipamento opera em caráter secundário, isto é, não tem direito à proteção contra interferência prejudicial, mesmo de estações do mesmo tipo, e não pode causar interferência a sistemas operando em caráter primário. (Res.ANATEL 282/2001).

Notice to users in Canada

Notice to users in Canada/Note à l'attention des utilisateurs canadiens

Under Industry Canada regulations, this radio transmitter may only operate using an antenna of a type and maximum (or lesser) gain approved for the transmitter by Industry Canada. To reduce potential radio interference to other users, the antenna type and its gain should be so chosen that the equivalent isotropically radiated power (e.i.r.p.) is not more than that necessary for successful communication.

This device complies with Industry Canada licence-exempt RSS standard(s). Operation is subject to the following two conditions: (1) this device may not cause interference, and (2) this device must accept any interference, including interference that may cause undesired operation of the device.

WARNING! Exposure to Radio Frequency Radiation The radiated output power of this device is below the Industry Canada radio frequency exposure limits. Nevertheless, the device should be used in such a manner that the potential for human contact is minimized during normal operation.

To avoid the possibility of exceeding the Industry Canada radio frequency exposure limits, human proximity to the antennas should not be less than 20 cm (8 inches).

Conformément au Règlement d'Industrie Canada, cet émetteur radioélectrique ne peut fonctionner qu'avec une antenne d'un type et d'un gain maximum (ou moindre) approuvé par Industrie Canada. Afin de réduire le brouillage radioélectrique potentiel pour d'autres utilisateurs, le type d'antenne et son gain doivent être choisis de manière à ce que la puissance isotrope rayonnée équivalente (p.i.r.e.) ne dépasse pas celle nécessaire à une communication réussie.

Cet appareil est conforme aux normes RSS exemptes de licence d'Industrie Canada. Son fonctionnement dépend des deux conditions suivantes : (1) cet appareil ne doit pas provoquer d'interférences nuisibles et (2) doit accepter toutes interférences reçues, y compris des interférences pouvant provoquer un fonctionnement non souhaité de l'appareil.

AVERTISSEMENT relatif à l'exposition aux radiofréquences. La puissance de rayonnement de cet appareil se trouve sous les limites d'exposition de radiofréquences d'Industrie Canada. Néanmoins, cet appareil doit être utilisé de telle sorte qu'il soit mis en contact le moins possible avec le corps humain.

Afin d'éviter le dépassement éventuel des limites d'exposition aux radiofréquences d'Industrie Canada, il est recommandé de maintenir une distance de plus de 20 cm entre les antennes et l'utilisateur.

Notice to users in Taiwan

低功率電波輻射性電機管理辦法

第十二條

經型式認證合格之低功率射頻電機，非經許可，公司、商號或使用者均不得擅自變更頻率、加大功率或變更設計之特性及功能。

第十四條

低功率射頻電機之使用不得影響飛航安全及干擾合法通信；經發現有干擾現象時，應立即停用，並改善至無干擾時方得繼續使用。

前項合法通信，指依電信法規定作業之無線電通信。低功率射頻電機須忍受合法通信或工業、科學及醫藥用電波輻射性電機設備之干擾。

Notice to users in Mexico

Aviso para los usuarios de México

La operación de este equipo está sujeta a las siguientes dos condiciones: (1) es posible que este equipo o dispositivo no cause interferencia perjudicial y (2) este equipo o dispositivo debe aceptar cualquier interferencia, incluyendo la que pueda causar su operación no deseada.

Para saber el modelo de la tarjeta inalámbrica utilizada, revise la etiqueta regulatoria de la impresora.

Notice to users in Japan

この機器は技術基準適合証明又は工事設計認証を受けた無線設備を搭載しています。

Regulatory model number

For regulatory identification purposes, your product is assigned a Regulatory Model Number. The Regulatory Model Number for your product is SNPRC-1203-01. This regulatory number should not be confused with the marketing name (HP Officejet Pro 251dw Printer) or product number.

Environmental product stewardship program

Hewlett-Packard is committed to providing quality products in an environmentally sustainable manner:

- Design for recycling has been incorporated into this product.
- The number of materials has been kept to a minimum while ensuring proper functionality and reliability.
- Dissimilar materials have been designed to separate easily.
- Fasteners and other connections are easy to locate, access, and remove using common tools.
- High priority parts have been designed to access quickly for efficient disassembly and repair.

For more information, visit www.hp.com/ecosolutions.

This section contains the following topics:

- [Paper use](#)
- [Plastics](#)
- [Material safety data sheets](#)
- [Recycling program](#)
- [HP inkjet supplies recycling program](#)
- [Disposal of waste equipment by users in private households in the European Union](#)
- [Power consumption](#)
- [Chemical Substances](#)
- [Battery information](#)
- [RoHS notices \(China only\)](#)
- [Restriction of hazardous substance \(Ukraine\)](#)

Paper use

This product is suited for the use of recycled paper according to DIN 19309 and EN 12281:2002.

Plastics

Plastic parts over 25 grams are marked according to international standards that enhance the ability to identify plastics for recycling purposes at the end of product life.

Material safety data sheets

Material safety data sheets (MSDS) can be obtained from the HP Web site at:

www.hp.com/go/msds

Recycling program

HP offers an increasing number of product return and recycling programs in many countries/regions, and partners with some of the largest electronic recycling centers throughout the world. HP conserves resources by reselling some of its most popular products. For more information regarding recycling of HP products, please visit:

www.hp.com/hpinfo/globalcitizenship/environment/recycle/

HP inkjet supplies recycling program

HP is committed to protecting the environment. The HP Inkjet Supplies Recycling Program is available in many countries/regions, and lets you recycle used print cartridges and ink cartridges free of charge. For more information, go to the following Web site:

www.hp.com/hpinfo/globalcitizenship/environment/recycle/

Disposal of waste equipment by users in private households in the European Union



Language	Text
English	<p>Disposal of Waste Equipment by Users in Private Households in the European Union</p> <p>This symbol on the product or its packaging indicates that this product must not be disposed of with your other household waste. Instead, it is your responsibility to dispose of your waste responsibly by taking it to a designated collection point for the recycling of waste electrical and electronic equipment. This separate collection and recycling of your waste electrical and electronic equipment will help to conserve natural resources and ensure that it is recycled in a manner that protects human health and the environment. For more information about where you can drop off your equipment for recycling, please consult your local authorities, your household waste disposal service, or the shop where you purchased the product.</p> <p>Entsorgung des Elektrogeräts durch Nutzer in Privathaushalten in der Europäischen Union</p> <p>In diesem Symbol ist ein Produkt oder seine Verpackung mit einem durchgehenden roten Balken über dem Symbol für den Müll dargestellt, was bedeutet, dass das Produkt nicht mit dem Hausmüll entsorgt werden darf. Stattdessen ist es Ihre Verantwortung, Ihr Produkt verantwortungsvoll zu entsorgen, indem Sie es an einen dafür vorgesehenen Sammelort für die Wiederverwertung von Elektrogeräten bringen. Diese getrennte Sammlung und Wiederverwertung von Elektrogeräten wird dazu beitragen, natürliche Ressourcen zu schonen und sicherzustellen, dass das Produkt in einer Weise recycelt wird, die den Menschen und die Umwelt schützt. Für weitere Informationen zu den Orten, an denen Sie Ihr Produkt für die Wiederverwertung bringen können, wenden Sie sich bitte an Ihre örtlichen Behörden, Ihren Hausmüll-Entsorgungsdienst oder den Geschäftsort, an dem Sie das Produkt erworben haben.</p> <p>Entsorgung von Elektrogeräten durch Nutzer in Privathaushalten in der EU</p> <p>Dieses Symbol auf dem Produkt oder seiner Verpackung gibt an, dass das Produkt nicht zusammen mit dem Hausmüll entsorgt werden darf. Stattdessen ist es Ihre Verantwortung, das Produkt verantwortungsvoll zu entsorgen, indem Sie es an einen dafür vorgesehenen Sammelort für die Wiederverwertung von Elektrogeräten bringen. Diese getrennte Sammlung und Wiederverwertung von Elektrogeräten wird dazu beitragen, natürliche Ressourcen zu schonen und sicherzustellen, dass das Produkt in einer Weise recycelt wird, die den Menschen und die Umwelt schützt. Für weitere Informationen zu den Orten, an denen Sie Ihr Produkt für die Wiederverwertung bringen können, wenden Sie sich bitte an Ihre örtlichen Behörden, Ihren Hausmüll-Entsorgungsdienst oder den Geschäftsort, an dem Sie das Produkt erworben haben.</p> <p>Disposal of Waste Electrical and Electronic Equipment (WEEE) by Users in Private Households in the European Union</p> <p>This symbol on the product or its packaging indicates that this product must not be disposed of with your other household waste. Instead, it is your responsibility to dispose of your waste responsibly by taking it to a designated collection point for the recycling of waste electrical and electronic equipment. This separate collection and recycling of your waste electrical and electronic equipment will help to conserve natural resources and ensure that it is recycled in a manner that protects human health and the environment. For more information about where you can drop off your equipment for recycling, please consult your local authorities, your household waste disposal service, or the shop where you purchased the product.</p> <p>Entsorgung von Elektrogeräten durch Nutzer in Privathaushalten in der Europäischen Union</p> <p>In diesem Symbol ist ein Produkt oder seine Verpackung mit einem durchgehenden roten Balken über dem Symbol für den Müll dargestellt, was bedeutet, dass das Produkt nicht mit dem Hausmüll entsorgt werden darf. Stattdessen ist es Ihre Verantwortung, Ihr Produkt verantwortungsvoll zu entsorgen, indem Sie es an einen dafür vorgesehenen Sammelort für die Wiederverwertung von Elektrogeräten bringen. Diese getrennte Sammlung und Wiederverwertung von Elektrogeräten wird dazu beitragen, natürliche Ressourcen zu schonen und sicherzustellen, dass das Produkt in einer Weise recycelt wird, die den Menschen und die Umwelt schützt. Für weitere Informationen zu den Orten, an denen Sie Ihr Produkt für die Wiederverwertung bringen können, wenden Sie sich bitte an Ihre örtlichen Behörden, Ihren Hausmüll-Entsorgungsdienst oder den Geschäftsort, an dem Sie das Produkt erworben haben.</p> <p>Disposal of Waste Electrical and Electronic Equipment (WEEE) by Users in Private Households in the European Union</p> <p>This symbol on the product or its packaging indicates that this product must not be disposed of with your other household waste. Instead, it is your responsibility to dispose of your waste responsibly by taking it to a designated collection point for the recycling of waste electrical and electronic equipment. This separate collection and recycling of your waste electrical and electronic equipment will help to conserve natural resources and ensure that it is recycled in a manner that protects human health and the environment. For more information about where you can drop off your equipment for recycling, please consult your local authorities, your household waste disposal service, or the shop where you purchased the product.</p> <p>Entsorgung von Elektrogeräten durch Nutzer in Privathaushalten in der Europäischen Union</p> <p>In diesem Symbol ist ein Produkt oder seine Verpackung mit einem durchgehenden roten Balken über dem Symbol für den Müll dargestellt, was bedeutet, dass das Produkt nicht mit dem Hausmüll entsorgt werden darf. Stattdessen ist es Ihre Verantwortung, Ihr Produkt verantwortungsvoll zu entsorgen, indem Sie es an einen dafür vorgesehenen Sammelort für die Wiederverwertung von Elektrogeräten bringen. Diese getrennte Sammlung und Wiederverwertung von Elektrogeräten wird dazu beitragen, natürliche Ressourcen zu schonen und sicherzustellen, dass das Produkt in einer Weise recycelt wird, die den Menschen und die Umwelt schützt. Für weitere Informationen zu den Orten, an denen Sie Ihr Produkt für die Wiederverwertung bringen können, wenden Sie sich bitte an Ihre örtlichen Behörden, Ihren Hausmüll-Entsorgungsdienst oder den Geschäftsort, an dem Sie das Produkt erworben haben.</p>
...	...

Power consumption

Hewlett-Packard printing and imaging equipment marked with the ENERGY STAR® logo is qualified to the U.S. Environmental Protection Agency's ENERGY STAR specifications for imaging equipment. The following mark appears on ENERGY STAR qualified imaging products:



Additional ENERGY STAR qualified imaging product model information is listed at:
www.hp.com/go/energystar

Chemical Substances

HP is committed to providing our customers with information about the chemical substances in our products as needed to comply with legal requirements such as REACH (*Regulation EC No 1907/2006 of the European Parliament and the Council*). A chemical information report for this product can be found at: www.hp.com/go/reach.

Battery information

This section contains the following topics:

- [Battery disposal in the Netherlands](#)
- [Battery disposal in Taiwan](#)
- [California Perchlorate Material Notice](#)

Battery disposal in the Netherlands

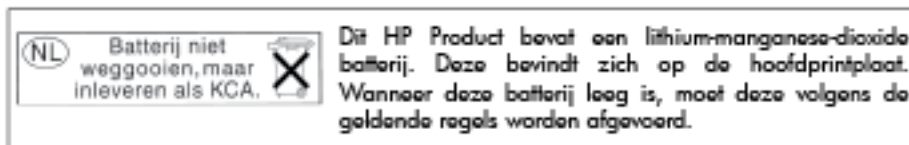

Battery disposal in Taiwan



廢電池請回收

Please recycle waste batteries.

California Perchlorate Material Notice

California Perchlorate Material Notice

Perchlorate material - special handling may apply. See:
<http://www.dtsc.ca.gov/hazardouswaste/perchlorate/>

This product's real-time clock battery or coin cell battery may contain perchlorate and may require special handling when recycled or disposed of in California.

RoHS notices (China only)

Toxic and hazardous substance table

零件描述	有毒有害物质表					
	铅	汞	镉	六价铬	多溴联苯	多溴联苯醚
外壳和托盘*	0	0	0	0	0	0
电线*	0	0	0	0	0	0
印刷电路板*	X	0	0	0	0	0
打印系统*	X	0	0	0	0	0
显示器*	X	0	0	0	0	0
喷墨打印机墨盒*	0	0	0	0	0	0
驱动光盘*	X	0	0	0	0	0
扫描仪*	X	X	0	0	0	0
网络配件*	X	0	0	0	0	0
电池板*	X	0	0	0	0	0
自动双面打印系统*	0	0	0	0	0	0
外部电源*	X	0	0	0	0	0

0: 指此部件的所有均一材质中包含的这种有毒有害物质, 含量低于SJ/T11363-2006 的限制
 X: 指此部件使用的均一材质中至少有一种包含的这种有毒有害物质, 含量高于SJ/T11363-2006 的限制
 注: 环保使用期限的参考标识取决于产品正常工作的温度和湿度等条件
 *以上只适用于使用这些部件的产品

Restriction of hazardous substance (Ukraine)

Технічний регламент щодо обмеження використання небезпечних речовин (Україна)

Обладнання відповідає вимогам Технічного регламенту щодо обмеження використання деяких небезпечних речовин в електричному та електронному обладнанні, затвердженого постановою Кабінету Міністрів України від 3 грудня 2008 № 1057

Third-party licenses

LICENSE.aes-pubdom--crypto

/* rijndael-alg-fst.c

*

* @version 3.0 (December 2000)

*

* Optimised ANSI C code for the Rijndael cipher (now AES)

*

* @author Vincent Rijmen <vincent.rijmen@esat.kuleuven.ac.be>

* @author Antoon Bosselaers <antoon.bosselaers@esat.kuleuven.ac.be>

* @author Paulo Barreto <paulo.barreto@terra.com.br>

*

* This code is hereby placed in the public domain.

*

* THIS SOFTWARE IS PROVIDED BY THE AUTHORS "AS IS" AND ANY EXPRESS

* OR IMPLIED WARRANTIES, INCLUDING, BUT NOT LIMITED TO, THE IMPLIED

* WARRANTIES OF MERCHANTABILITY AND FITNESS FOR A PARTICULAR PURPOSE

* ARE DISCLAIMED. IN NO EVENT SHALL THE AUTHORS OR CONTRIBUTORS BE

* LIABLE FOR ANY DIRECT, INDIRECT, INCIDENTAL, SPECIAL, EXEMPLARY, OR

* CONSEQUENTIAL DAMAGES (INCLUDING, BUT NOT LIMITED TO, PROCUREMENT OF

* SUBSTITUTE GOODS OR SERVICES; LOSS OF USE, DATA, OR PROFITS; OR

* BUSINESS INTERRUPTION) HOWEVER CAUSED AND ON ANY THEORY OF LIABILITY,

* WHETHER IN CONTRACT, STRICT LIABILITY, OR TORT (INCLUDING NEGLIGENCE

* OR OTHERWISE) ARISING IN ANY WAY OUT OF THE USE OF THIS SOFTWARE,

* EVEN IF ADVISED OF THE POSSIBILITY OF SUCH DAMAGE.

*/

LICENSE.expat-mit--expat

Copyright (c) 1998, 1999, 2000 Thai Open Source Software Center Ltd

Permission is hereby granted, free of charge, to any person obtaining a copy of this software and associated documentation files (the "Software"), to deal in the Software without restriction, including without limitation the rights to use, copy, modify, merge, publish, distribute, sublicense, and/or sell copies of the Software, and to permit persons to whom the Software is furnished to do so, subject to the following conditions:

The above copyright notice and this permission notice shall be included in all copies or substantial portions of the Software.

THE SOFTWARE IS PROVIDED "AS IS", WITHOUT WARRANTY OF ANY KIND, EXPRESS OR IMPLIED, INCLUDING BUT NOT LIMITED TO THE WARRANTIES OF MERCHANTABILITY, FITNESS FOR A PARTICULAR PURPOSE AND NONINFRINGEMENT. IN NO EVENT SHALL THE AUTHORS OR COPYRIGHT HOLDERS BE LIABLE FOR ANY CLAIM, DAMAGES OR OTHER LIABILITY, WHETHER IN AN ACTION OF CONTRACT, TORT OR OTHERWISE, ARISING FROM, OUT OF OR IN CONNECTION WITH THE SOFTWARE OR THE USE OR OTHER DEALINGS IN THE SOFTWARE.

LICENSE.hmac-sha2-bsd--nos_crypto

/* HMAC-SHA-224/256/384/512 implementation

* Last update: 06/15/2005

* Issue date: 06/15/2005

*

* Copyright (C) 2005 Olivier Gay (olivier.gay@a3.epfl.ch)

* All rights reserved.

*

* Redistribution and use in source and binary forms, with or without

* modification, are permitted provided that the following conditions

* are met:

* 1. Redistributions of source code must retain the above copyright

* notice, this list of conditions and the following disclaimer.

* 2. Redistributions in binary form must reproduce the above copyright

* notice, this list of conditions and the following disclaimer in the

* documentation and/or other materials provided with the distribution.

* 3. Neither the name of the project nor the names of its contributors

* may be used to endorse or promote products derived from this software

* without specific prior written permission.

*

* THIS SOFTWARE IS PROVIDED BY THE PROJECT AND CONTRIBUTORS ``AS IS" AND

* ANY EXPRESS OR IMPLIED WARRANTIES, INCLUDING, BUT NOT LIMITED TO, THE

* IMPLIED WARRANTIES OF MERCHANTABILITY AND FITNESS FOR A PARTICULAR PURPOSE

* ARE DISCLAIMED. IN NO EVENT SHALL THE PROJECT OR CONTRIBUTORS BE LIABLE

* FOR ANY DIRECT, INDIRECT, INCIDENTAL, SPECIAL, EXEMPLARY, OR CONSEQUENTIAL

* DAMAGES (INCLUDING, BUT NOT LIMITED TO, PROCUREMENT OF SUBSTITUTE GOODS

* OR SERVICES; LOSS OF USE, DATA, OR PROFITS; OR BUSINESS INTERRUPTION)

* HOWEVER CAUSED AND ON ANY THEORY OF LIABILITY, WHETHER IN CONTRACT, STRICT

* HOWEVER CAUSED AND ON ANY THEORY OF LIABILITY, WHETHER IN CONTRACT, STRICT

* LIABILITY, OR TORT (INCLUDING NEGLIGENCE OR OTHERWISE) ARISING IN ANY WAY

* OUT OF THE USE OF THIS SOFTWARE, EVEN IF ADVISED OF THE POSSIBILITY OF

* SUCH DAMAGE.

*/

LICENSE.md4-pubdom--jm_share_folder

LibTomCrypt is public domain. As should all quality software be.

All of the software was either written by or donated to Tom St Denis for the purposes of this project. The only exception is the SAFER.C source which has no known license status (assumed copyrighted) which is why SAFER.C is shipped as disabled.

Tom St Denis

LICENSE.md5-pubdom--jm_share_folder

LibTomCrypt is public domain. As should all quality software be.

All of the software was either written by or donated to Tom St Denis for the purposes of this project. The only exception is the SAFER.C source which has no known license status (assumed copyrighted) which is why SAFER.C is shipped as disabled.

Tom St Denis

LICENSE.open_ssl--open_ssl

Copyright (C) 1995-1998 Eric Young (eay@cryptsoft.com)

All rights reserved.

This package is an SSL implementation written by Eric Young (eay@cryptsoft.com).

The implementation was written so as to conform with Netscapes SSL.

This library is free for commercial and non-commercial use as long as the following conditions are aheared to. The following conditions apply to all code found in this distribution, be it the RC4, RSA, lhash, DES, etc., code; not just the SSL code. The SSL documentation included with this distribution is covered by the same copyright terms except that the holder is Tim Hudson (tjh@cryptsoft.com).

Copyright remains Eric Young's, and as such any Copyright notices in the code are not to be removed.

If this package is used in a product, Eric Young should be given attribution as the author of the parts of the library used.

This can be in the form of a textual message at program startup or in documentation (online or textual) provided with the package.

Redistribution and use in source and binary forms, with or without modification, are permitted provided that the following conditions are met:

1. Redistributions of source code must retain the copyright notice, this list of conditions and the following disclaimer.
2. Redistributions in binary form must reproduce the above copyright

notice, this list of conditions and the following disclaimer in the documentation and/or other materials provided with the distribution.

3. All advertising materials mentioning features or use of this software must display the following acknowledgement:

"This product includes cryptographic software written by Eric Young (eay@cryptsoft.com)"

The word 'cryptographic' can be left out if the routines from the library being used are not cryptographic related :-).

4. If you include any Windows specific code (or a derivative thereof) from the apps directory (application code) you must include an acknowledgement:

"This product includes software written by Tim Hudson (tjh@cryptsoft.com)"

THIS SOFTWARE IS PROVIDED BY ERIC YOUNG ``AS IS'' AND ANY EXPRESS OR IMPLIED WARRANTIES, INCLUDING, BUT NOT LIMITED TO, THE IMPLIED WARRANTIES OF MERCHANTABILITY AND FITNESS FOR A PARTICULAR PURPOSE ARE DISCLAIMED. IN NO EVENT SHALL THE AUTHOR OR CONTRIBUTORS BE LIABLE FOR ANY DIRECT, INDIRECT, INCIDENTAL, SPECIAL, EXEMPLARY, OR CONSEQUENTIAL DAMAGES (INCLUDING, BUT NOT LIMITED TO, PROCUREMENT OF SUBSTITUTE GOODS OR SERVICES; LOSS OF USE, DATA, OR PROFITS; OR BUSINESS INTERRUPTION) HOWEVER CAUSED AND ON ANY THEORY OF LIABILITY, WHETHER IN CONTRACT, STRICT LIABILITY, OR TORT (INCLUDING NEGLIGENCE OR OTHERWISE) ARISING IN ANY WAY OUT OF THE USE OF THIS SOFTWARE, EVEN IF ADVISED OF THE POSSIBILITY OF SUCH DAMAGE.

The licence and distribution terms for any publically available version or derivative of this code cannot be changed. i.e. this code cannot simply be copied and put under another distribution licence [including the GNU Public Licence.]

=====
Copyright (c) 1998-2001 The OpenSSL Project. All rights reserved.

Redistribution and use in source and binary forms, with or without modification, are permitted provided that the following conditions are met:

1. Redistributions of source code must retain the above copyright notice, this list of conditions and the following disclaimer.
2. Redistributions in binary form must reproduce the above copyright notice, this list of conditions and the following disclaimer in the documentation and/or other materials provided with the distribution.
3. All advertising materials mentioning features or use of this software must display the following acknowledgment:

"This product includes software developed by the OpenSSL Project for use in the OpenSSL Toolkit. (<http://www.openssl.org/>)"

4. The names "OpenSSL Toolkit" and "OpenSSL Project" must not be used to endorse or promote products derived from this software without prior written permission. For written permission, please contact openssl-core@openssl.org.

5. Products derived from this software may not be called "OpenSSL" nor may "OpenSSL" appear in their names without prior written permission of the OpenSSL Project.

6. Redistributions of any form whatsoever must retain the following acknowledgment:

"This product includes software developed by the OpenSSL Project for use in the OpenSSL Toolkit (<http://www.openssl.org/>)"

THIS SOFTWARE IS PROVIDED BY THE OpenSSL PROJECT ``AS IS'' AND ANY EXPRESSED OR IMPLIED WARRANTIES, INCLUDING, BUT NOT LIMITED TO, THE IMPLIED WARRANTIES OF MERCHANTABILITY AND FITNESS FOR A PARTICULAR PURPOSE ARE DISCLAIMED. IN NO EVENT SHALL THE OpenSSL PROJECT OR ITS CONTRIBUTORS BE LIABLE FOR ANY DIRECT, INDIRECT, INCIDENTAL, SPECIAL, EXEMPLARY, OR CONSEQUENTIAL DAMAGES (INCLUDING, BUT NOT LIMITED TO, PROCUREMENT OF SUBSTITUTE GOODS OR SERVICES; LOSS OF USE, DATA, OR PROFITS; OR BUSINESS INTERRUPTION) HOWEVER CAUSED AND ON ANY THEORY OF LIABILITY, WHETHER IN CONTRACT, STRICT LIABILITY, OR TORT (INCLUDING NEGLIGENCE OR OTHERWISE) ARISING IN ANY WAY OUT OF THE USE OF THIS SOFTWARE, EVEN IF ADVISED OF THE POSSIBILITY OF SUCH DAMAGE.

=====

This product includes cryptographic software written by Eric Young (eay@cryptsoft.com). This product includes software written by Tim Hudson (tjh@cryptsoft.com).

=====

Copyright (c) 1998-2006 The OpenSSL Project. All rights reserved.

Redistribution and use in source and binary forms, with or without modification, are permitted provided that the following conditions are met:

1. Redistributions of source code must retain the above copyright notice, this list of conditions and the following disclaimer.

2. Redistributions in binary form must reproduce the above copyright notice, this list of conditions and the following disclaimer in the documentation and/or other materials provided with the distribution.
3. All advertising materials mentioning features or use of this software must display the following acknowledgment:
"This product includes software developed by the OpenSSL Project for use in the OpenSSL Toolkit. (<http://www.openssl.org/>)"
4. The names "OpenSSL Toolkit" and "OpenSSL Project" must not be used to endorse or promote products derived from this software without prior written permission. For written permission, please contact openssl-core@openssl.org.
5. Products derived from this software may not be called "OpenSSL" nor may "OpenSSL" appear in their names without prior written permission of the OpenSSL Project.
6. Redistributions of any form whatsoever must retain the following acknowledgment:
"This product includes software developed by the OpenSSL Project for use in the OpenSSL Toolkit (<http://www.openssl.org/>)"

THIS SOFTWARE IS PROVIDED BY THE OpenSSL PROJECT ``AS IS'' AND ANY EXPRESSED OR IMPLIED WARRANTIES, INCLUDING, BUT NOT LIMITED TO, THE IMPLIED WARRANTIES OF MERCHANTABILITY AND FITNESS FOR A PARTICULAR PURPOSE ARE DISCLAIMED. IN NO EVENT SHALL THE OpenSSL PROJECT OR ITS CONTRIBUTORS BE LIABLE FOR ANY DIRECT, INDIRECT, INCIDENTAL, SPECIAL, EXEMPLARY, OR CONSEQUENTIAL DAMAGES (INCLUDING, BUT NOT LIMITED TO, PROCUREMENT OF SUBSTITUTE GOODS OR SERVICES; LOSS OF USE, DATA, OR PROFITS; OR BUSINESS INTERRUPTION) HOWEVER CAUSED AND ON ANY THEORY OF LIABILITY, WHETHER IN CONTRACT, STRICT LIABILITY, OR TORT (INCLUDING NEGLIGENCE OR OTHERWISE) ARISING IN ANY WAY OUT OF THE USE OF THIS SOFTWARE, EVEN IF ADVISED OF THE POSSIBILITY OF SUCH DAMAGE.

=====

This product includes cryptographic software written by Eric Young (ey@cryptsoft.com). This product includes software written by Tim Hudson (tjh@cryptsoft.com).

=====

Copyright 2002 Sun Microsystems, Inc. ALL RIGHTS RESERVED.
ECC cipher suite support in OpenSSL originally developed by

SUN MICROSYSTEMS, INC., and contributed to the OpenSSL project.

LICENSE.sha2-bsd--nos_crypto

/* FIPS 180-2 SHA-224/256/384/512 implementation

* Last update: 02/02/2007

* Issue date: 04/30/2005

*

* Copyright (C) 2005, 2007 Olivier Gay <olivier.gay@a3.epfl.ch>

* All rights reserved.

*

* Redistribution and use in source and binary forms, with or without

* modification, are permitted provided that the following conditions

* are met:

* 1. Redistributions of source code must retain the above copyright

* notice, this list of conditions and the following disclaimer.

* 2. Redistributions in binary form must reproduce the above copyright

* notice, this list of conditions and the following disclaimer in the

* documentation and/or other materials provided with the distribution.

* 3. Neither the name of the project nor the names of its contributors

* may be used to endorse or promote products derived from this software

* without specific prior written permission.

*

* THIS SOFTWARE IS PROVIDED BY THE PROJECT AND CONTRIBUTORS ``AS IS" AND

* ANY EXPRESS OR IMPLIED WARRANTIES, INCLUDING, BUT NOT LIMITED TO, THE

* IMPLIED WARRANTIES OF MERCHANTABILITY AND FITNESS FOR A PARTICULAR
PURPOSE

* ARE DISCLAIMED. IN NO EVENT SHALL THE PROJECT OR CONTRIBUTORS BE LIABLE

* FOR ANY DIRECT, INDIRECT, INCIDENTAL, SPECIAL, EXEMPLARY, OR CONSEQUENTIAL

* DAMAGES (INCLUDING, BUT NOT LIMITED TO, PROCUREMENT OF SUBSTITUTE GOODS

* OR SERVICES; LOSS OF USE, DATA, OR PROFITS; OR BUSINESS INTERRUPTION)

* HOWEVER CAUSED AND ON ANY THEORY OF LIABILITY, WHETHER IN CONTRACT,
STRICT

* LIABILITY, OR TORT (INCLUDING NEGLIGENCE OR OTHERWISE) ARISING IN ANY WAY

* OUT OF THE USE OF THIS SOFTWARE, EVEN IF ADVISED OF THE POSSIBILITY OF

* SUCH DAMAGE.

*/

LICENSE.unicode--jm_share_folder

/*

* Copyright 2001-2004 Unicode, Inc.

*

* Disclaimer

*

* This source code is provided as is by Unicode, Inc. No claims are

* made as to fitness for any particular purpose. No warranties of any
* kind are expressed or implied. The recipient agrees to determine
* applicability of information provided. If this file has been
* purchased on magnetic or optical media from Unicode, Inc., the
* sole remedy for any claim will be exchange of defective media
* within 90 days of receipt.

*

* Limitations on Rights to Redistribute This Code

*

* Unicode, Inc. hereby grants the right to freely use the information
* supplied in this file in the creation of products supporting the
* Unicode Standard, and to make copies of this file in any form
* for internal or external distribution as long as this notice
* remains attached.

*/

LICENSE.zlib--zlib

zlib.h -- interface of the 'zlib' general purpose compression library
version 1.2.3, July 18th, 2005

Copyright (C) 1995-2005 Jean-loup Gailly and Mark Adler

This software is provided 'as-is', without any express or implied
warranty. In no event will the authors be held liable for any damages
arising from the use of this software.

Permission is granted to anyone to use this software for any purpose,
including commercial applications, and to alter it and redistribute it
freely, subject to the following restrictions:

1. The origin of this software must not be misrepresented; you must not
claim that you wrote the original software. If you use this software
in a product, an acknowledgment in the product documentation would be
appreciated but is not required.
2. Altered source versions must be plainly marked as such, and must not be
misrepresented as being the original software.
3. This notice may not be removed or altered from any source distribution.

Jean-loup Gailly Mark Adler

jloup@gzip.org madler@alumni.caltech.edu

The data format used by the zlib library is described by RFCs (Request for
Comments) 1950 to 1952 in the files <http://www.ietf.org/rfc/rfc1950.txt>
(zlib format), [rfc1951.txt](#) (deflate format) and [rfc1952.txt](#) (gzip format).

B HP supplies and accessories

This section provides information on HP supplies and accessories for the printer. The information is subject to changes, visit the HP website (www.hpshopping.com) for the latest updates. You may also make purchases through the website.

 **NOTE:** Not all cartridges are available in all countries/regions.

This section contains the following topics:

- [Order printing supplies online](#)
- [Supplies](#)

Order printing supplies online

To order supplies online or create a printable shopping list, open the HP software that came with your printer and click **Shop**. Select **Shop for Supplies Online**. The HP software uploads, with your permission, printer information, including model number, serial number, and estimated ink levels. The HP supplies that work in your printer are pre-selected. You can change quantities, add or remove items, and then print the list or purchase online at the HP Store or other online retailers (options differ by country/region). Cartridge information and links to online shopping also appear on ink alert messages.

You can also order online by visiting www.hp.com/buy/supplies. If prompted, select your country/region, follow the prompts to select your printer, and then the supplies you need.

 **NOTE:** Ordering cartridges online is not supported in all countries/regions. However, many countries have information on ordering by telephone, locating a local store and printing a shopping list. In addition, you can select the 'How to Buy' option at the top of the www.hp.com/buy/supplies page to obtain information about purchasing HP products in your country.

Supplies

- [Ink cartridges and printheads](#)
- [HP paper](#)

Ink cartridges and printheads

Ordering cartridges online is not supported in all countries/regions. However, many countries have information on ordering by telephone, locating a local store and printing a shopping list. In addition, you can select the 'How to Buy' option at the top of the www.hp.com/buy/supplies page to obtain information about purchasing HP products in your country.

Use only the replacement cartridges that have the same cartridge number as the ink cartridge you are replacing. You can find the cartridge number in the following places:

- In the embedded web server, by clicking the **Tools** tab, and then, under **Product Information** clicking **Ink Gauge**. For more information, see [Embedded web server](#).
 - On the printer status report (see [Understand the Printer Status Report](#)).
 - On the label of the ink cartridge you are replacing.
- On a sticker inside the printer.

 **CAUTION:** The **Setup** ink cartridge that comes with the printer is not available for separate purchase. Check for the correct cartridge number through the EWS, on the printer status report, or on the sticker inside the printer.

 **NOTE:** Ink level warnings and indicators provide estimates for planning purposes only. When you receive a low-ink warning message, consider having a replacement cartridge available to avoid possible printing delays. You do not need to replace cartridges until prompted to do so.

HP paper

To order paper such as HP Premium Paper, go to www.hp.com.



HP recommends plain papers with the ColorLok logo for printing and copying of everyday documents. All papers with the ColorLok logo are independently tested to meet high standards of reliability and print quality, and produce documents with crisp, vivid color, bolder blacks, and that dry faster than ordinary plain papers. Look for papers with the ColorLok logo in a variety of weights and sizes from major paper manufacturers.

C Network setup

You can manage network settings for the printer through the printer control panel as described in the next section. Additional advanced settings are available in the embedded web server, a configuration and status tool you access from your web browser using an existing network connection to the printer. For more information, see [Embedded web server](#).

This section contains the following topics:

- [Change basic network settings](#)
- [Change advanced network settings](#)
- [Set up the printer for wireless communication](#)
- [Uninstall and reinstall the HP software](#)

Change basic network settings

The control panel options enable you to set up and manage a wireless connection and to perform a variety of network management tasks. This includes viewing the network settings, restoring the network defaults, turning the wireless radio on and off, and changing the network settings.

This section contains the following topics:

- [View and print network settings](#)
- [Turn the wireless radio on and off](#)

View and print network settings

You can display a summary of the network settings on the printer control panel or the HP software that came with the printer. You can print a more detailed network configuration page, which lists all of the important network settings such as the IP address, link speed, DNS, and mDNS. For more information, see [Understand the network configuration page](#).

Turn the wireless radio on and off

The wireless radio is on by default, as indicated by the blue light on the front of the printer. In order to stay connected to a wireless network, the radio must stay on. However, if your printer is connected to an Ethernet network or you have a USB connection, the radio is turned off.

1. Touch  (right arrow), touch **Setup**, and then touch **Network**.
2. Touch **Wireless**, and then touch **On** to turn on the radio, or touch **Off** to turn off the radio.

For information about connecting the printer to a wireless network, see [Set up the printer for wireless communication](#). If the Wireless Setup Wizard is used to connect the printer to a wireless network the radio is automatically turned on.

Change advanced network settings

 **CAUTION:** Network settings are provided for your convenience. However, unless you are an advanced user, you should not change some of these settings (such as the link speed, IP settings, default gateway, and firewall settings).

This section contains the following topics:

- [Set link speed](#)
- [View IP settings](#)
- [Change IP settings](#)
- [Configure the printer's firewall settings](#)
- [Reset network settings](#)

Set link speed

You can change the speed at which data is transmitted over the network. The default is **Automatic**.

1. Touch , touch **Setup**, and then touch **Network**.
2. Touch **Advanced Setup**, then touch **Link Speed**.
3. Touch the number next to the link speed that matches your network hardware.

View IP settings

To view the IP address of the printer:

- Print the network configuration page. For more information, see [Understand the network configuration page](#).
-Or-
- Open the HP software (Windows), double-click **Estimated Ink Levels**, click the **Device Information** tab. The IP address is listed in the **Network Information** section.

Change IP settings

The default IP setting for the IP settings is **Automatic**, which sets the IP settings automatically. However, if you are an advanced user, you might want to manually change settings such as the IP address, subnet mask, or the default gateway.

 **CAUTION:** Be careful when manually assigning an IP address. If you enter an invalid IP address during the installation, your network components cannot connect with the printer.

1. Touch , touch **Setup**, and then touch **Network**.
2. Touch **Advanced Setup**, and then touch **IP Settings**.
3. A message appears warning that changing the IP address removes the printer from the network. Touch **OK** to continue.
4. **Automatic** is selected by default. To change the settings manually, touch **Manual**, and then enter the appropriate information for the following settings:
 - **IP Address**
 - **Subnet Mask**
 - **Default Gateway**
 - **DNS Address**
5. Enter your changes, and then touch **Done**.

Configure the printer's firewall settings

Firewall features provide network-layer security on both IPv4 and IPv6 networks. The firewall provides simple control of IP addresses that are allowed access.

 **NOTE:** In addition to firewall protection at the network layer, the printer also supports open secure sockets layer (SSL) standards at the transport layer for secure client-server applications, such as client-server authentication or HTTPS web browsing.

For firewall operation on the printer, you must configure a firewall policy to apply to specified IP traffic. Firewall policy pages are accessed through the EWS and displayed by your web browser.

After a policy is configured, it is not activated until you click **Apply** in the EWS.

Creating and using firewall rules

Firewall rules allow you to control IP traffic. Use firewall rules to allow or drop IP traffic based on IP addresses and services.

Enter up to ten rules, each rule specifying the host addresses, services, and the action to take for those addresses and services.

This section contains the following topics:

- [Create a firewall rule](#)
- [Change the priority of firewall rules](#)
- [Change firewall options](#)
- [Reset firewall settings](#)
- [Limitations to rules, templates, and services](#)

Create a firewall rule

To create a firewall rule, complete the following steps:

1. Open the embedded web server. For more information, see [Embedded web server](#).
2. Click the **Settings** tab, click **Firewall Rules**.
3. Click **New**, and then follow the onscreen instructions.

 **NOTE:** After clicking **OK**, the connection to the EWS might be temporarily disrupted for a short period of time. If the IP address was unchanged, the EWS connection will be enabled again. However, if the IP address was changed, use the new IP address to open the EWS.

Change the priority of firewall rules

To change the priority in which a firewall rule is used, complete the following steps:

1. Open the embedded web server. For more information, see [Embedded web server](#).
2. Click the **Settings** tab, click **Firewall Rules Priority**.
3. Select the priority in which you want the rule to be used from the **Rule Precedence** list, with 10 having the highest priority and 1 having the lowest priority.
4. Click **Apply**.

Change firewall options

To change firewall options for the printer, complete the following steps:

1. Open the embedded web server. For more information, see [Embedded web server](#).
2. Click the **Settings** tab, click **Firewall Options**.
3. Change any settings, and then click **Apply**.

 **NOTE:** After clicking **Apply**, the connection to the EWS might be temporarily disrupted for a short period of time. If the IP address was unchanged, the EWS connection will be enabled again. However, if the IP address was changed, use the new IP address to open the EWS.

Reset firewall settings

To reset the firewall settings to the factory defaults, restore the printer’s network settings. For more information, see [Reset network settings](#).

Limitations to rules, templates, and services

When creating firewall rules, note the following limitations to rules, templates, and services.

Item	Limit
Maximum number of rules.	11 (one default rule)
Maximum number of Address Templates.	12
Maximum number of user-defined address templates.	5
Maximum number of services you can add to a user-defined service template.	40

(continued)

Item	Limit
NOTE: The predefined All Services template is not subject to this limitation and includes all services supported by the print server.	
Maximum number of services you can add to the policy. For a given rule, only one address template and one service template can be added.	40
Maximum number of service templates in the policy.	9
Maximum number of user-defined custom service templates.	5

Reset network settings

To reset the administrator password and network settings, complete the following steps:

1. On the printer control panel, touch  (right arrow), touch **Setup**, and then touch **Network**.
2. Touch **Restore Network Defaults**, and then select **Yes**.

A message appears stating that the network defaults have been restored.

 **NOTE:** Print the network configuration page and verify that the network settings have been reset. For more information, see [Understand the network configuration page](#).

NOTE: Resetting the printer's network settings also resets the printer's firewall settings. For more information about configuring the printer's firewall settings, see [Configure the printer's firewall settings](#).

Set up the printer for wireless communication

You can set up the printer for wireless communication.

This section contains the following topics:

- [Before you begin](#)
- [Set up the printer on your wireless network](#)
- [Change the connection type](#)
- [Test the wireless connection](#)
- [Guidelines for ensuring wireless network security](#)
- [Guidelines for reducing interference on a wireless network](#)

 **NOTE:** If you encounter problems connecting the printer, see [Solve wireless problems](#).

 **TIP:** For more information about setting up and using the printer wirelessly, visit the HP Wireless Printing Center (www.hp.com/go/wirelessprinting).

Before you begin

Before you begin setting up the wireless connection, check the following:

- The printer is not connected to the network using a network cable.
- The wireless network is set up and functioning correctly.
- The printer and the computers that use the printer are on the same network (subnet).

While connecting the printer, you might be prompted to enter the wireless network name (SSID) and a wireless password:

- The wireless network name is the name of your wireless network.
- The wireless password prevents other people from connecting to your wireless network without your permission. Depending on the level of security required, your wireless network might use either a WEP key or WPA passphrase.

If you have not changed the network name or the security passkey since setting up your wireless network, you can sometimes find them on the back or side of the wireless router.

If you cannot find the network name or the security passkey or cannot remember this information, see the documentation available with your computer or with the wireless router. If you still cannot find this information, contact your network administrator or the person who set up the wireless network.

 **TIP:** If you are using a computer running Windows, HP provides a tool called HP Print and Scan Doctor that can help retrieve this information for some systems. To use this tool, visit the HP Wireless Printing Center (www.hp.com/go/wirelessprinting). (At this time, this tool might not be available in all languages.)

Set up the printer on your wireless network

To set up the printer on your wireless network, use one of the following methods:

- Set up the printer using the HP printer software
- Set up the printer using the Wireless Setup Wizard
- Set up the printer using WiFi Protected Setup (WPS)
- Set up the printer using the embedded web server (EWS)

 **NOTE:** If you have already been using the printer with a different type of connection, such as a USB connection, follow the instructions in [Change the connection type](#) to set up the printer on your wireless network.

Set up the printer using the HP printer software

In addition to enabling key printer features, you can use the HP printer software that came with your printer to set up wireless communication.

If you have already been using the printer with a different type of connection, such as a USB connection, follow the instructions in [Change the connection type](#) to set up the printer on your wireless network.

Set up the printer using the Wireless Setup Wizard

The Wireless Setup Wizard provides an easy way to set up and manage a wireless connection to your printer from the printer control panel.

1. Set up the printer hardware. See the getting started guide or the setup poster that came with your printer.
2. On the printer control panel, touch  (right arrow), touch **Setup**, and then touch **Network**.
3. Touch **Wireless Setup Wizard**, and then touch **OK**.
4. Follow the display instructions to complete the setup.
5. After the setup has completed, the network printer drivers can be installed by opening the printer's **HP** folder in **All Programs**, clicking **Printer Setup and Software**, and selecting **Connect a new printer**.

 **NOTE:** If you cannot find the wireless network name (SSID) and wireless password (WPA passphrase, WEP key), see [Before you begin](#).

Set up the printer using WiFi Protected Setup (WPS)

Wi-Fi Protected Setup (WPS) allows you to quickly set up the printer on your wireless network, without having to enter the wireless network name (SSID), wireless password (WPA passphrase, WEP key), or other wireless settings.

 **NOTE:** Only set up wireless using WPS if your wireless network uses WPA data encryption. If your wireless network uses WEP or is not using any encryption at all, use one of the other methods provided in this section to set up the printer on your wireless network.

NOTE: To use WPS, make sure your wireless router or wireless access point supports WPS.

Routers that support WPS often have a  (WPS) button or a button labeled "WPS".

You can use one of the following methods to set up the printer using WPS:

- Push Button Method: Use the  (WPS) or WPS button, if available, on your router.
- PIN Method: Enter the PIN generated by the printer in the router's configuration software.

To connect the printer using the Push Button Method

1. On the printer control panel, touch , touch **Setup**, and then touch **Network**.
2. Touch **Wi-Fi Protected Setup**, and then follow the on-screen instructions.
3. When prompted, touch **Push Button**.
4. On the wireless router or wireless access point, press and hold the WPS button for 3 seconds. Wait for about 2 minutes. If the printer connects successfully, the wireless light stops blinking but remains lit.
5. After the setup has completed, the network printer drivers can be installed by opening the printer's **HP** folder in **All Programs**, clicking **Printer Setup and Software**, and selecting **Connect a new printer**.

To connect the printer using the PIN Method

1. On the printer control panel, touch , touch **Setup**, and then touch **Network**. A WPS PIN is printed at the bottom of the page.
2. Touch **Wi-Fi Protected Setup**, and then follow the on-screen instructions.
3. When prompted, touch **PIN**. The WPS PIN appears on the display.
4. Open the configuration utility or software for the wireless router or wireless access point, and then enter the WPS PIN.

 **NOTE:** For more information about using the configuration utility, see the documentation provided with the router or wireless access point.

Wait for about 2 minutes. If the printer connects successfully, the wireless light stops blinking but remains lit.

5. After the setup has completed, the network printer drivers can be installed by opening the printer's **HP** folder in **All Programs**, clicking **Printer Setup and Software**, and selecting **Connect a new printer**.

Set up the printer using the embedded web server (EWS)

If the printer is connected to a network, you can use the printer's embedded web server (EWS) to set up wireless communication.

1. Open the EWS. For more information, see [Embedded web server](#).
2. On the **Home** tab, click **Wireless Setup Wizard** in the **Setup** box.

3. Follow the on-screen instructions.
4. After the setup has completed, the network printer drivers can be installed by opening the printer's **HP** folder in **All Programs**, clicking **Printer Setup and Software**, and selecting **Connect a new printer**.

 **TIP:** You can also set up wireless communication by entering or changing individual wireless settings. To change these settings, on the **Network** tab, click **Advanced** in the **Wireless (802.11)** section on the left, change the wireless settings, and then click **Apply**.

Change the connection type

After you have installed the HP software and connected the printer to your computer or to a network, you can use the HP software to change the connection type (for example, from a USB connection to a wireless connection).

 **NOTE:** If you are changing to a wireless connection, make sure that an Ethernet cable has not been connected to the printer. Connecting an Ethernet cable turns off the printer's wireless capabilities.

You might be prompted to temporarily connect a USB cable during the setup process.

To change from an Ethernet connection to a wireless connection

1. On the printer control panel, touch  (right arrow), touch **Setup**, and then touch **Network**.
2. Touch **Wireless**, touch **Wireless Setup Wizard**, and then touch **OK**.
3. Follow the display instructions to complete the setup.

 **NOTE:** If you cannot find the wireless network name (SSID) and wireless password (WPA passphrase, WEP key), see [Before you begin](#).

To change from a USB connection to a wireless connection

Follow the instructions for your operating system.

Windows

1. On the computer desktop, click **Start**, select **Programs** or **All Programs**, click **HP**, click the folder for your printer, and then click **Printer Setup & Software**.
- Or -
On the **Start** screen, click **Printer Setup & Software**.
2. Click **Convert a USB connected printer to wireless**.
3. Follow the display instructions to complete the setup.

Mac OS X

1. Open **HP Utility**. For more information, see [HP Utility \(Mac OS X\)](#).
2. Click the **Applications** icon on the HP Utility toolbar.
3. Double-click **HP Setup Assistant**, and then follow the on-screen instructions.

To change from a wireless connection to a USB or Ethernet connection

To change from a wireless connection to a USB or Ethernet connection, connect the USB or Ethernet cable to the printer.

 **NOTE:** If you are using a computer with Mac OS X, add the printer to the print queue. Click **System Preferences** in the Dock, click **Print & Fax** or **Print & Scan** in the **Hardware** section, click +, and then select the printer.

Test the wireless connection

Print the wireless test page for information about the printer's wireless connection. The wireless test page provides information about the printer's status, hardware (MAC) address, and IP address. If the printer is connected to a network, the test page displays details about the network settings.

To print the wireless test page

1. On the printer control panel, touch  (right arrow), touch **Setup**, and then touch **Network**.
2. Touch **Wireless**, and then touch **Print Wireless Network Test**.

Guidelines for ensuring wireless network security

The following information can help you keep your wireless network and wireless printer secure from unauthorized use.

For more information, visit www.hp.com/go/wirelessprinting.

This section contains the following topics:

- [Overview of security settings](#)
- [Add hardware addresses to a wireless router \(MAC filtering\)](#)
- [Other wireless security guidelines](#)

Overview of security settings

To help improve the security of the wireless network and prevent unauthorized access, the printer supports many common types of network authentication, including WEP, WPA, and WPA2.

- **WEP:** Provides security by encrypting data sent over radio waves from one wireless device to another wireless device. Devices on a WEP-enabled network use WEP keys to encode data. If your network uses WEP, you must know the WEP key(s) it uses.
- **WPA:** Increases the level of over-the-air data protection and access control on existing and future wireless networks. It addresses all known weaknesses of WEP, the original native security mechanism in the 802.11 standard. WPA uses the Temporal Key Integrity Protocol (TKIP) for encryption and employs 802.1X authentication with one of the standard Extensible Authentication Protocol (EAP) types available today.
- **WPA2:** Provides enterprise and consumer wireless users with a high level of assurance that only authorized users can access their wireless networks. WPA2 provides the Advanced Encryption Standard (AES). AES is defined in counter cipher-block chaining mode (CCM) and supports the Independent Basic Service Set (IBSS) to enable security between client workstations operating connected wirelessly without a wireless router (such as a Linksys wireless router or Apple AirPort Base Station).

Add hardware addresses to a wireless router (MAC filtering)

MAC filtering is a security feature in which a wireless router or wireless access point is configured with a list of hardware addresses (also called "MAC addresses") of devices that are allowed to gain access to the network through the router.

If the router filters hardware addresses, then the printer's hardware address must be added to the router's list of accepted hardware addresses. If the router does not have the hardware address of a printer attempting to access the network, the router denies the printer access to the network.

 **CAUTION:** This method is not recommended, however, because your MAC addresses can easily be read and falsified by unwanted users outside your network.

To add hardware addresses to a wireless router or wireless access point

1. Print the network configuration page, and then locate the printer's hardware address. For more information, see [Understand the network configuration page](#).



NOTE: The printer maintains separate hardware addresses for the Ethernet connection and for wireless connection. Both hardware addresses are listed on the printer's network configuration page.

2. Open the configuration utility for the wireless router or wireless access point, and add the printer's hardware address to the list of accepted hardware addresses.



NOTE: For more information about using the configuration utility, see the documentation provided with the router or wireless access point.

Other wireless security guidelines

To keep the wireless network secure, follow these guidelines:

- Use a wireless password with at least 20 random characters. You can use up to 64 characters in a WPA wireless password.
- Avoid any common words or phrases, easy sequences of characters (such as all 1s), and personally-identifiable information for wireless passwords. Always use random strings composed of uppercase and lowercase letters, numbers, and if allowed, special characters such as punctuation.
- Change the default wireless password provided by the manufacturer for administrator access to the access point or wireless router. Some routers let you change the administrator name as well.
- Turn off administrative access over wireless if possible. If you do this, you need to connect to the router with an Ethernet connection when you want to make configuration changes.
- Turn off remote administrative access over the Internet on your router, if possible. You can use Remote Desktop to make an encrypted connection to a computer running behind your router and make configuration changes from the local computer you are accessing over the Internet.
- To avoid accidentally connecting to another party's wireless network, turn off the setting to automatically connect to non-preferred networks. This is disabled by default in Windows XP.

Guidelines for reducing interference on a wireless network

The following tips will help reduce the chances for interference in a wireless network:

- Keep the wireless devices away from large metal objects, such as filing cabinets, and other electromagnetic devices, such as microwaves and cordless telephones, as these objects can disrupt radio signals.
- Keep the wireless devices away from large masonry structures and other building structures as these objects can absorb radio waves and lower signal strength.
- Position the access point or wireless router in a central location in line of sight with the wireless devices on the network.
- Keep all wireless devices on the network within range of one another.

Uninstall and reinstall the HP software

If your installation is incomplete, or if you connected the USB cable to the computer before prompted by the HP software installation screen, you might need to uninstall and then reinstall the HP software that came with the printer. Do not simply delete the printer application files from your computer. Make sure to remove them correctly using the uninstall utility provided when you installed the HP software.

- [Windows](#)
- [Mac OS X](#)

Windows

To uninstall — method 1

1. Disconnect the printer from your computer. Do not connect it to your computer until after you have reinstalled the HP software.
2. On the computer desktop, click **Start**, select **Programs** or **All Programs**, click **HP**, click the printer name, and then click **Uninstall**.
3. Follow the on-screen instructions.
4. If you are asked whether you would like to remove shared files, click **No**.
Other programs that use these files might not work correctly if the files are deleted.
5. Restart your computer.
6. To reinstall the HP software, insert the HP software CD into your computer's CD drive, and follow the on-screen instructions.
7. Connect the printer when the HP software prompts you to connect it to the computer.
8. Press the  (Power button) to turn the printer on.
After connecting and turning on the printer, you might have to wait several minutes for all of the Plug and Play events to complete.
9. Follow the on-screen instructions.

To uninstall — method 2

 **NOTE:** Use this method if **Uninstall** is not available in the Windows Start menu.

1. On the computer desktop, click **Start**, select **Settings**, click **Control Panel**, and then click **Add/Remove Programs**.
- Or -
Click **Start**, click **Control Panel**, and then double-click **Programs and Features**.
2. Select the printer name, and then click **Change/Remove** or **Uninstall/Change**.
Follow the on-screen instructions.
3. Disconnect the printer from your computer.
4. Restart your computer.

 **NOTE:** It is important that you disconnect the printer before restarting your computer. Do not connect the printer to your computer until after you have reinstalled the HP software.

5. Insert the HP software CD into your computer's CD drive and then start the Setup program.
6. Follow the on-screen instructions.

Mac OS X

To uninstall from a Mac computer

1. Double-click the **HP Uninstaller** icon (located in the **Hewlett-Packard** folder in the **Applications** folder at the top level of the hard disk), and then click **Continue**.
2. When prompted, type the correct administrator's name and password, and then click **OK**.
3. Follow the on-screen instructions.
4. When the **HP Uninstaller** finishes, restart your computer.

D Printer management tools

This section contains the following topics:

- [Toolbox \(Windows\)](#)
- [HP Utility \(Mac OS X\)](#)
- [Embedded web server](#)
- [Product security features](#)

Toolbox (Windows)

The Toolbox provides maintenance information about the printer.

 **NOTE:** The Toolbox can be installed from the HP Software CD if the computer meets the system requirements.

Open the Toolbox

1. From the computer desktop, click the **Start** tab, select **Programs** or **All Programs**, click **HP**, click the folder for your printer, and then select the icon with your printer's name.
2. On the **Print** tab, under the **Print** section, double-click **Maintain Your Printer**.

HP Utility (Mac OS X)

HP Utility contains tools to configure print settings, calibrate the printer, order supplies online, and find website support information.

 **NOTE:** The features available in HP Utility vary depending on the selected printer. Ink level warnings and indicators provide estimates for planning purposes only. When you receive a low on ink message, consider having a replacement cartridge available to avoid possible printing delays. You do not need to replace cartridges until prompted to do so.

Open HP Utility

To open HP Utility

Double-click the **HP Utility** icon. This icon is located in the **Hewlett-Packard** folder in the **Applications** folder at the top level of the hard disk.

Embedded web server

When the printer is connected to a network, you can use the printer's home page (embedded web server or EWS) to view status information, change settings, and manage it from your computer.

 **NOTE:** For a list of system requirements for the embedded web server, see [Embedded web server specifications](#).

To view or change some settings, you might need a password.

You can open and use the embedded web server without being connected to the Internet. However, some features are not available.

This section contains the following topics:

- [About cookies](#)
- [To open the embedded web server](#)
- [Embedded web server features](#)

About cookies

The embedded web server (EWS) places very small text files (cookies) on your hard drive when you are browsing. These files let the EWS recognize your computer the next time you visit. For example, if you have configured the EWS language, a cookie helps remember which language you have selected so that the next time you access the EWS, the pages are displayed in that language. Though some cookies are cleared at the end of each session (such as the cookie that stores the selected language), others (such as the cookie that stores customer-specific preferences) are stored on the computer until you clear them manually.

 **NOTE:** The cookies that the EWS stores on your computer are only used for saving settings on your computer or for sharing information between the printer and the computer. These cookies are not sent to any HP websites.

You can configure your browser to accept all cookies, or you can configure it to alert you every time a cookie is offered, which allows you to decide which cookies to accept or refuse. You can also use your browser to remove unwanted cookies.

 **NOTE:** Depending on your printer, if you disable cookies, you also disable one or more of the following features:

- Starting where you left the application (especially useful when using setup wizards)
- Remembering the EWS browser language setting
- Personalizing the EWS Home page

For information about how to change your privacy and cookie settings and how to view or delete cookies, see the documentation available with your web browser.

To open the embedded web server

 **NOTE:** The printer must be on a network and must have an IP address. The IP address and hostname for the printer are listed on the status report. For more information, see [Understand the network configuration page](#).

In a supported web browser on your computer, type the IP address or hostname assigned to the printer.

For example, if the IP address is 123.123.123.123, type the following address into the web browser:
`http://123.123.123.123`

 **TIP:** After opening the embedded web server, you can bookmark it so that you can return to it quickly.

TIP: If you are using the Safari web browser in Mac OS X, you can also use the Bonjour bookmark to open the EWS without typing the IP address. To use the Bonjour bookmark, open Safari, and then from the **Safari** menu, click **Preferences**. On the **Bookmarks** tab, in the **Bookmarks bar** section, select **Include Bonjour**, and then close the window. Click the **Bonjour** bookmark, and then select your networked printer to open the EWS.

Embedded web server features

 **NOTE:** Changing network settings in the HP EWS might disable some product or product software features.

Use the **Home** tab to customize various views and tasks related to your device. The **Home** tab includes the following items:

- **Recently Visited:** Displays the five most recently visited embedded HP EWS links.
- **Printer Status:** Displays current printer status.
- **Diagnostic:** Provide links to diagnostic tasks.

- **ePrint:** Displays the status of ePrint connection.
- **Ink Level Status:** Displays ink level status.
- **Manage:** Useful links for managing the HP EWS.
- **Wireless Network Status:** Displays wireless (802.11) status.
- **Wired Network Status:** Displays wired (802.3) status.
- **Setup:** Displays setup options.
- **Custom Shortcut:** Customize quick links to be added as shortcut.
- **Support:** Links to Hewlett-Packard's support Web site.



NOTE: Not all of the above items are visible by default. Use the **Personalize this page** button to show or hide the items of your choice.

NOTE: Settings for this page are automatically saved in the Web browser's cookies. If the Web browser's cookies are deleted, these settings are lost.

Use the **HP Web Services** tab to configure and enable HP Web Services for this product. You must enable HP Web Services to use the HP ePrint feature.

Use the **Network** tab to configure and secure network settings for the product when it is connected to an IP-based network. This tab does not display if the product is connected to other types of networks.

Tools tab

- **Product Information**
 - **Printer Information:** Find basic device information such as serial number, name and firmware version.
 - **Ink Gauge:** See estimated ink levels, ink cartridge part numbers, and estimated printable pages remaining for each cartridge.
 - **Ink Settings:** Change the threshold at which the printer provides the "Low on Ink" notification.
- **Reports**
 - **Usage Report:** View the number of pages processed for printing, scanning, copying and faxing.
 - **Printer Reports:** Print various reports.
 - **Event Log:** View logged events such as firmware errors.
- **Utilities**
 - **Bookmarking:** Bookmark pages in the HP EWS.
 - **Print Quality Toolbox:** Run maintenance tools to improve the print quality of your printouts.
 - **Asset Tracking:** Assign an asset number/location to this device.
- **Backup and Restore**
 - **Backup:** Create a password-encrypted file that stores the printer's settings.
 - **Restore:** Restore the printer's settings using a backup file created by the HP EWS.
- **Job Monitor**

Job Monitor: Monitor or cancel jobs currently active or pending in the printer.
- **Printer Restart**
 - **Power Cycle:** Allows you to turn off and restart the printer.
 - **Restore:** Restore the printer's settings using a backup file created by the HP EWS.

Use the **Settings** tab to set and maintain various options on your product including power management, date and time, security, printing, and paper settings, email alerts, restore factory defaults and firewall settings.

Product security features

This product supports security standards and protocols that help secure the product, protect information on your network, and simplify monitoring and maintenance of the product.

For information about HP's secure imaging and printing solutions, visit www.hp.com/go/Secureprinting. The site provides links to white papers and FAQ documents about security features and may include information about additional security features that are not contained in this document.

Assign an administrator password in the embedded web server

The embedded web server allows you to assign an administrator password so that unauthorized users cannot change product configuration settings in the embedded web server. When the admin password is assigned and applied, you must enter the password to make any configuration changes that are done through the embedded web server. If you change an existing password, you must first enter that password. You can also remove the password by entering the existing password and then deleting the assigned password.

Control panel lock

The embedded web server allows the ability to lock certain features on the product's control panel to prevent unauthorized use. Once the control panel lock is enabled, certain control panel configuration features cannot be changed from the control panel. The control panel lock setting itself can also be secured. This is accomplished by setting the embedded web server administrator password. Once the embedded web server administrator password is set, the admin password must be entered when accessing the control panel lock enable/disable setting.

Disable unused protocols and services

The embedded web server allows the ability to disable unused protocols and services. These protocol and services settings can also be protected from being changed by setting the EWS admin password. These protocols and services include the following:

- **IPv4 and IPv6 disable/enable:** To operate properly on a TCP/IP network, the product must be configured with valid TCP/IP network configuration settings, such as an IP address that is valid for your network. This product supports two versions of this protocol: version 4 (IPv4) and version 6 (IPv6). IPv4 and IPv6 can be enabled/disable individually or simultaneously enabled.
- **Bonjour disable/enable:** Bonjour services are typically used on small networks for IP address and name resolution where conventional a DNS server is not used. The Bonjour service can be enabled or disabled.
- **SNMP disable/enable:** SNMP (Simple Network Management Protocol) is used by network management applications for product management. This product supports the SNMPv1 protocol on IP networks. This product allows the ability to enable/disable SNMPv1.
- **WINS disable/enable:** If you have a Dynamic Host Configuration Protocol (DHCP) service on your network, the product automatically obtains its IP address from that server and registers its name with any RFC 1001 and 1002-compliant dynamic name services as long as the Windows Internet Name Service (WINS) server IP address has been specified. The WINS server IP address configuration can be enable or disabled. If enabled, then the primary and secondary WINS server can be specified.
- **SLP disable/enable:** Service Location Protocol (SLP) is an Internet standard network protocol that provides a framework to allow network applications to discover the existence, location and configuration of networked services in enterprise networks. This protocol can be enabled or disabled.
- **LPD disable/enable:** Line Printer Daemon (LPD) refers to the protocol and programs associated with line-printer spooling services that may be installed on various TCP/IP systems. LPD can be enabled or disabled.

- **LLMNR disable/enable:** Link-Local Multicast Name Resolution (LLMNR) is a protocol based on the Domain Name System (DNS) packet format that allows both IPv4 and IPv6 hosts to perform name resolution for hosts on the same local link. LLMNR can be enabled or disabled.
- **Port 9100 disable/enable:** The product supports raw IP printing through TCP Port 9100. This HP-proprietary TCP/IP port on the product is the default port for printing and it is accessed by HP software. Port 9100 can be enabled or disabled.
- **Web Services disable/enable:** The product supports the ability to enable or disable Microsoft Web Services Dynamic Discovery (WS Discovery) protocols or Microsoft Web Services for Devices (WSD) Print services supported on the product. These web services can be enabled or disabled together or WS Discovery can be enabled separately.
- **Internet Printing Protocol (IPP) disable/enable:** Internet Printing Protocol (IPP) is an Internet-standard protocol that allows you to print documents and manage jobs over the internet. IPP can be disabled or enabled.

Administrator settings

The embedded web server allows the ability to enable and disable certain product capabilities. These include network, Ethernet, wireless, wireless access point (i.e. disables wireless direct capability), USB, control panel lock, color print from memory devices, all web services, only ePrint, and only Apps. The product must be turned off, and then turned on again, for settings to take effect.

Color access control

HP's suite of color access control tools allows you to enable or disable color by individuals users or groups and applications. For more information see www.hp.com/go/upd. The embedded web server also allows you to disable color faxing, color copying, and color print from memory devices.

Protected protocols – HTTPS

The embedded web server features the ability to enable encryption of product communication through the HTTPS redirection feature. When used, HTTPS prevents others from viewing information between the EWS and the product via encryption – providing a secure communication method.

Firewall

The embedded web server allows the ability to enable and configure product firewall rules, priorities, templates, services and policies. The firewall feature provides a network-layer of security on both IPv4 and IPv6 networks. The firewall configuration capability provides control over IP addresses that are allowed access the product, and the ability to set permissions and priorities for digital send, management, discovery, and print services--providing a more secure way of controlling access to the product.

Syslog

Support of Syslog, a standard protocol for logging status messages to a designated server, can be used to track the activities and status of devices on the network. The embedded web service provides the ability to enable Syslog and to specify the server to which the status messages will be sent. Specifying the priority of those status messages is also supported.

Certificates

The embedded web server provides the ability to install and manage certificates for the authentication of product, server and network. This includes the ability to create a certificate, install a certificate, and import and export certificates.

Signed firmware

Support of digitally-signed firmware updates eliminates exposure to malicious software by preventing the installation of non-approved firmware on the product.

Wireless authentication

The embedded web server provides the ability to configure wireless networking via such 802.1x wireless enterprise authentication protocols as EAP-TLS, LEAP, and PEAP to support access control. The HP Embedded Web Server also provides the ability to configure wireless dynamic key encryption such as WEP encryption and WPA-PSK authentication. In addition, Wireless Direct Authentication can be enabled or disabled.

E How do I?

- [Get started](#)
- [Print](#)
- [Work with ink cartridges](#)
- [Solve a problem](#)

F Errors (Windows)

Printer disconnected

The computer cannot communicate with the printer because one of the following events has occurred:

- The printer has been turned off.
- The cable connecting the printer, such as a USB cable or a network (Ethernet) cable, has been disconnected.
- If the printer is connected to a wireless network, the wireless connection has been broken.

To solve this problem, try the following solutions:

- Make sure the printer is turned on and that the  (Power button) light is on.
- Make sure the power cord and other cables are working and are firmly connected to the printer.
- Make sure the power cord is connected firmly to a functioning, alternating current (AC) power outlet.
- If the printer is connected to a network, make sure the network is functioning properly. For more information, see [Solve Ethernet network problems](#).
- If the printer is connected to a wireless network, make sure the wireless network is functioning properly. For more information, see [Solve wireless problems](#).

Printhead problem

The printhead is missing, not detected, incorrectly installed, or incompatible.

If this error occurs at printer setup, try the following solutions.

Solution 1: Reinstall the printhead.

For instructions, see [Reinstall the printhead](#)

 **CAUTION:** The printheads contain electrical contacts that can be damaged easily.

If the problem persists after you reinstall the printhead, contact HP support. For more information, see [HP support](#).

If this error occurs after the printer has been used for a period of time, try the following solutions.

Solution 1: Turn the printer off and on.

Turn off the printer, and then turn it on again.

If the problem persists, contact HP support for service or replacement. For more information, see [HP support](#).

Cartridge Problem

The ink cartridge identified in the message is missing, damaged, incompatible, or inserted into the wrong slot in the printer.

 **NOTE:** If the cartridge is identified in the message as incompatible, see [Order printing supplies online](#) for information about obtaining cartridges for the printer.

To solve this problem, try the following solutions. Solutions are listed in order, with the most likely solution first. If the first solution does not solve the problem, continue trying the remaining solutions until the issue is resolved.

- Solution 1: Turn the printer off and on.
- Solution 2: Install the ink cartridges correctly.
- Solution 3: Clean the electrical contacts.
- Solution 4: Replace the ink cartridge.

Solution 1: Turn the printer off and on

Turn off the printer, and then turn it on again.

If the problem persists, try the next solution.

Solution 2: Install the ink cartridges correctly

Make sure all of the ink cartridges are properly installed:

1. Gently pull open the ink cartridge access door.
2. Remove the ink cartridge by grasping it and pulling it firmly toward you.
3. Insert the cartridge into the slot. Press firmly on the cartridge to ensure proper contact.
4. Close the ink cartridge cover and check if the error message has gone away.

If the problem persists, try the next solution.

Solution 3: Clean the electrical contacts

To clean the electrical contacts in the printer

1. Lightly dampen a clean, lint-free cloth with bottled or distilled water.
2. Clean the electrical contacts in the printer by wiping with the cloth from top to bottom. Use as many fresh, clean cloths as necessary. Clean until no ink shows on the cloth.
3. Wipe the area dry with a dry lint-free cloth before proceeding to the next step.

Solution 4: Replace the ink cartridge

Replace the indicated ink cartridge. For more information, see [Replace the ink cartridges](#).



NOTE: If your cartridge is still under warranty, contact HP support for service or replacement. For more information about ink cartridge warranty, see [Ink cartridge warranty information](#). If the problem persists after you replace the cartridge, contact HP support. For more information, see [HP support](#).

Replace the ink cartridge

Replace the indicated ink cartridge. For more information, see [Replace the ink cartridges](#).



NOTE: If your cartridge is still under warranty, contact HP support for service or replacement. For more information about ink cartridge warranty, see [Ink cartridge warranty information](#). If the problem persists after you replace the cartridge, contact HP support. For more information, see [HP support](#).

Paper Mismatch

The paper size or type selected in the printer driver does not match the paper loaded in the printer. Make sure that the correct paper is loaded in the printer, and then print the document again. For more information, see [Load paper](#).



NOTE: If the paper loaded in the printer is the correct size, change the selected paper size in the printer driver, and then print the document again.

The cartridge cradle cannot move

Something is blocking the ink cartridge cradle (the part of the printer that holds the ink cartridges).

To clear the obstruction, press  (Power button) to turn off the printer, and then check the printer for jams.

For more information, see [Clear jams](#).

Paper Jam

Paper has become jammed in the printer.

Before you try to clear the jam, check the following:

- Make sure that you have loaded paper that meets specifications and is not wrinkled, folded, or damaged. For more information, see [Paper specifications](#).
- Make sure that the printer is clean. For more information, see [Maintain the printer](#).
- Make sure that the trays are loaded correctly and are not too full. For more information, see [Load paper](#).

For instructions on clearing jams, as well as more information about how to avoid jams, see [Clear jams](#).

The printer is out of paper



The default tray is empty.

Load more paper, and then touch **OK**.

For more information, see [Load paper](#).

Printer failure

There was a problem with the printer. Usually, you can resolve such problems by completing the following steps:

1. Press  (Power button) to turn off the printer.
2. Unplug the power cord, and then plug in the power cord again.
3. Press  (Power button) to turn on the printer.

If this problem persists, write down the error code provided in the message, and then contact HP support. For more information about contacting HP support, see [HP support](#).

Door or cover open

Before the printer can print documents, all doors and covers must be closed.

 **TIP:** When completely closed, most doors and covers snap into place.

If the problem persists after you've securely closed all doors and covers, contact HP support. For more information, see [HP support](#).

Ink cartridges depleted

The cartridges listed in the message must be replaced to resume printing. HP recommends that you do not remove an ink cartridge until a replacement is ready to install.

For more information, see [Replace the ink cartridges](#).

Ink cartridge failure

The cartridges listed in the message are damaged or have failed.
See [Replace the ink cartridges](#).

Printer supply upgrade problem

The supply upgrade was not successful. The cartridges listed in the message can still be used in this printer. Replace the Supply Upgrade cartridge. For more information, see [Replace the ink cartridges](#).

Counterfeit Cartridge Advisory

The installed cartridge is not a new, genuine HP cartridge. Contact the store where this cartridge was purchased. To report suspected fraud, visit HP at www.hp.com/go/antcounterfeit. To continue using the cartridge, click Continue.

Use SETUP cartridges

When you first setup the printer, you must install the cartridges that shipped in the box with the printer. These cartridges are labeled SETUP, and they calibrate your printer before the first print job. Failure to install the SETUP cartridges during the initial product setup causes an error. If you installed a set of regular cartridges, remove them and install the SETUP cartridges to complete printer setup. After printer setup is complete, the printer can use regular cartridges.

If you still receive error messages and the printer cannot complete ink system initialization, contact HP support. For more information, see [HP support](#).

[Click here to go online for more information](#).

Do not use SETUP cartridges

New SETUP cartridges cannot be installed after the printer has been initialized. Install regular replacement cartridges. For more information, see [Replace the ink cartridges](#).

Not enough ink at startup

The used cartridges listed in the message might not have enough ink to complete one-time startup processes.

Solution: Install new cartridges or click **OK** to use installed cartridges.

If startup cannot complete with installed cartridges, new cartridges will be needed. For information on how to install new cartridges, see [Replace the ink cartridges](#).

Incompatible ink cartridges

The ink cartridge is not compatible with your printer.

Solution: Remove this cartridge immediately and replace with a compatible ink cartridge. For information about how to install new cartridges, see [Replace the ink cartridges](#).

Ink sensor warning

The ink sensor is reporting an unexpected condition. This could be caused by the cartridge, or the sensor may have failed. If the sensor has failed, it can no longer sense when your cartridges are very low on ink. Printing with an empty cartridge will cause air to enter the ink system, which causes poor print quality. Significant amounts of ink will be used up to recover from this condition, which will deplete much of the ink supply for all cartridges.

Solution: Click **OK** to continue printing or replace the cartridge. For information about how to install new cartridges, see [Replace the ink cartridges](#).

Problem with printer preparation

The printer clock has failed and ink preparation may not be complete. The estimated Ink Level gauge might be inaccurate.

Solution: Check the print quality of your print job. If it is not satisfactory, running the printhead cleaning procedure from the toolbox might improve it.

Ink sensor failure

The ink sensor has failed and the printer can no longer print.

Contact HP support. For more information, see [HP support](#).

Problem with ink system

Please remove the ink cartridges and examine them for any sign of leaks. If any cartridges have leaks, contact HP. Do not use cartridges that are leaking.

If there are no leaks, re-install cartridges and close the printer cover. Turn the printer off then on again. If you get this message a second time, contact HP.

Index

- A**
 - accessibility 7
 - accessories
 - installation 21
 - printer status report 77
 - turn on and off in driver 24
 - warranty 88
 - acoustic emissions 97
 - after the support period 52
 - align printhead 79
- B**
 - blank pages, troubleshoot
 - print 56
 - both sides, print on 37
 - buttons, control panel 11
- C**
 - calibrate linefeed 79
 - cameras
 - insert memory cards 20
 - Cancel button 11
 - capacity
 - trays 94
 - cards
 - sizes supported 93
 - tray supporting 94
 - cartridges. *See* ink cartridges
 - clean
 - exterior 25
 - printhead 78
 - Configure
 - firewall 72
 - connection type
 - change 126
 - connectors, locating 10
 - control panel
 - buttons 11
 - lights 11
 - status icons 12
 - custom-size paper
 - Mac OS X 34
 - print on 33
 - custom-sized media
 - sizes supported 94
 - custom-sized paper
 - Mac OS X 34
 - Windows X 33
 - customer support
 - electronic 51
 - cut-off pages, troubleshoot 57
- D**
 - diagnostic page 60
 - digital cameras
 - insert memory cards 20
 - double-sided printing 37
 - driver
 - accessories settings 24
 - warranty 88
 - duplexer
 - clear jams 84
 - installation 21
 - media sizes supported 92
 - paper types and weights supported 94
 - turn on and off in driver 24
 - duty cycle 91
- E**
 - electrical specifications 97
 - embedded web server
 - about 130
 - opening 131
 - troubleshoot, cannot be opened 73
 - envelopes
 - sizes supported 92
 - tray supporting 94
 - environmental specifications 96
 - environmental sustainability program 105
 - EWS. *See* embedded web server
- F**
 - Firewall
 - configure 72
 - firewall settings 121
 - firewalls, troubleshoot 54
 - fonts supported 91
- G**
 - glass, scanner
 - locating 9
- H**
 - head 78
 - Help 12
 - Hewlett-Packard Company
 - notices 3
 - HP software
 - uninstall from Windows 129
 - HP Utility (Mac OS X)
 - opening 130
 - humidity specifications 96
- I**
 - ink cartridge access door,
 - locating 10
 - ink cartridges
 - check ink levels 46
 - locating 10
 - ordering online 118
 - part numbers 77, 118
 - replace 47
 - status 77
 - supported 90
 - tips 45
 - warranty 88
 - warranty expiration
 - dates 77
 - yields 90
 - ink level icons 13
 - ink levels, check 46
 - installation
 - accessories 21
 - duplexer 21
 - hardware installation
 - suggestions 74
 - HP software installation
 - suggestions 75
 - tray 2 22
 - troubleshooting issues 74
 - IP address
 - checking for printer 74
 - IP settings 121

J

- jams
 - clear 84
 - paper 84, 86

L

- language, printer 90, 91
- lights, control panel 11
- linefeed, calibrate 79
- link speed, setting 121
- load
 - photo 18
 - tray 16, 17
 - tray 2 22
- load cards 18
- load custom-size paper 19
- load envelopes 17
- load paper 16
- locking trays 23

M

- Mac OS
 - custom-size paper 34
 - Print photos 32
 - print settings 28
 - turn accessories on and off in driver 24
- Mac OS X
 - HP Utility 130
- maintain
 - printhead 78
- maintenance
 - align printhead 79
 - calibrate linefeed 79
 - check ink levels 46
 - clean printhead 78
 - diagnostic page 60
 - print quality report 60
 - printhead 78
 - replace ink cartridges 47

margins

- setting, specifications 95

media

- clear jams 84
- duplexing 37
- load tray 16
- load tray 2 22
- locking trays 23
- skewed pages 63
- supported sizes 92
- troubleshoot feeding 62

- memory
 - specifications 91
- memory cards
 - insert 20
 - specifications 97
- memory devices
 - print files 32
 - troubleshoot 65
- missing or incorrect information, troubleshoot 56
- MMC memory card
 - insert 20
- model number 77
- multi-feeds, troubleshoot 63

N

- networks
 - advanced settings 120
 - connector illustration 10
 - firewall settings 121
 - firewalls, troubleshoot 54
 - IP settings 121
 - link speed 121
 - settings, change 120
 - solve problems 75
 - view and print settings 120
 - wireless communication setup 123
 - wireless settings 82
- noise information 97

O

- operating environment
 - specifications 96
- operating systems
 - supported 91
- output tray
 - locating 9
 - media supported 95

P

- pages per month (duty cycle) 91
- paper
 - HP, order 119
 - jams 84, 86
 - print on custom-size 33
 - selecting 16
 - specifications 92
 - types and weights supported 94
- paper, select 14

- paper-feed problems, troubleshoot 62
- PCL 5 support 90
- PCL 6 support 90
- PDF 5 support 90
- phone support 51
- phone support period
 - period for support 52
- photo media
 - sizes supported 93
- Photo screen 12
- photos
 - insert memory cards 20
 - print from memory devices 32
 - troubleshoot memory devices 65
- ports, specifications 90
- power
 - specifications 97
 - troubleshoot 53
- power input, locating 10
- print
 - diagnostic page 60
 - double-sided 37
 - photos from memory devices 32
 - print quality report 60
 - printer status report 77
 - troubleshoot 53
- Print brochures
 - print 29
- Print envelope 30
- Print envelopes
 - Mac OS X 31
- Print photos
 - Mac OS X 32
 - Windows 31
- print quality report 60
- print settings
 - print quality 57
- printer control panel
 - locating 9
 - network settings 120
- printer driver
 - accessories settings 24
 - warranty 88
- printer software (Windows)
 - about 130
 - opening 26, 130
- printer status report
 - information on 76
 - print 77

- printhead
 - clean 78
- printhead latch, locating 10
- printhead, align 79
- printheads
 - ordering online 118
 - supported 90
- printing
 - slow, troubleshoot 54
- processor specifications 91
- PS3 support 90

R

- radio interference
 - reducing 128
 - regulatory information 102
- radio, turn off 120
- rear access panel
 - clear jams 84
 - illustration 10
- recycle
 - ink cartridges 105
- regulatory information 99, 102
- regulatory model number 104
- replace ink cartridges 47
- report
 - wireless test 127
- reports
 - diagnostic 60
 - print quality 60
 - printhead 78
- right navigation button 11

S

- scanner glass
 - locating 9
- Secure Digital memory card
 - insert 20
- security
 - wireless
 - communication 127
- serial number 77
- settings
 - network 120
- Setup 12
- shipping environment
 - specifications 97
- skew, troubleshoot
 - print 63
- software
 - accessories settings 24
 - warranty 88

- sound pressure 97
- specifications
 - acoustic emissions 97
 - electrical 97
 - operating environment 96
 - paper 92
 - physical 90
 - processor and memory 91
 - shipping environment 97
 - system requirements 91
- status
 - network configuration
 - page 82
 - printer status report 77
- status icons 12
- storage devices
 - USB flash drives
 - supported 97
- supplies
 - ordering online 118
 - printer status report 77
 - yields 90
- support 50
- system requirements 91

T

- technical information
 - memory card
 - specifications 97
- temperature specifications 96
- text
 - troubleshoot 57
- tray 1
 - capacity 94
 - media sizes supported 92
 - paper types and weights
 - supported 94
- tray 2
 - capacity 94
 - installation 22
 - load media 22
 - media sizes supported 92
 - paper types and weights
 - supported 94
 - turn on and off in driver 24
- trays
 - capacities 94
 - clear jams 84
 - installation tray 2 22
 - load paper 16
 - locating 9
 - locking 23
 - media sizes supported 92

- paper guides illustration 9
- paper types and weights
 - supported 94
- setting default 23
- troubleshoot feeding 62
- turn on and off in driver 24
- troubleshoot
 - blank pages printed 56
 - cut-off pages, incorrect text
 - or graphics placement 57
 - embedded web server 73
 - firewalls 54
 - jams, paper 86
 - media not picked up from tray 62
 - memory devices 65
 - missing or incorrect information 56
 - multiple pages are picked 63
 - network configuration
 - page 82
 - nothing prints 53
 - paper-feed problems 62
 - power 53
 - print 53
 - printer status report 76
 - skewed pages 63
 - tips 52
- troubleshooting
 - Ethernet network 66
 - general network
 - troubleshooting 66
 - hardware installation
 - suggestions 74
 - HP software installation
 - suggestions 75
 - installation issues 74
 - solve network problems 75
 - wireless problems 66
- two-sided printing 37

U

- uninstall HP software
 - Windows 129
- USB connection
 - port, locating 9, 10
 - specifications 90
- USB flash drives 97

Index

V

view

network settings 120

voltage specifications 97

W

warranty 88

websites

accessibility information 7

customer support 51

environmental

programs 105

order supplies and

accessories 118

supply yield data sheet 90

Windows

custom-size paper 33

print brochures 29

Print photos 31

print settings 27

system requirements 91

turn accessories on and off

in driver 24

uninstall HP software 129

wireless communication

advanced wireless

troubleshooting 67

basic wireless

troubleshooting 66

radio, turn off 120

reducing interference 128

regulatory information 102

security 127

set up 123

wireless connection icons 12

wireless test report

print 127

X

xD-Picture memory card

insert 20

© 2013 Hewlett-Packard Development Company, L.P.
www.hp.com

