

User's Guide

Dell B1265dnf

BASIC

This guide provides information concerning installation, basic operation and troubleshooting on windows.

ADVANCED

This guide provides information about installation, advanced configuration, operation and troubleshooting on various OS environments.

Some features may not be available depending on models or countries.



1. Introduction

Key benefits	5
Features	6
Useful to know	8
About this user's guide	9
Safety information	10
Machine overview	15
Control panel overview	18
Turning on the machine	20
Installing the driver locally	21
Reinstalling the driver	23



2. Menu overview and basic setup

Menu overview	25
Changing the display language	30
Media and tray	31
Basic printing	45
Basic copying	51
Basic scanning	55
Basic faxing	56



3. Maintenance

Ordering supplies and accessories	61
Available supplies	62
Storing the toner cartridge	63
Redistributing toner	65
Replacing the toner cartridge	66
Monitoring the supplies life	67
Setting the toner low alert	68
Cleaning the machine	69
Tips for moving & storing your machine	73



4. Troubleshooting

Tips for avoiding paper jams	75
Clearing original document jams	76
Clearing paper jams	80
Understanding the status LED	85
Understanding display messages	87



5. Appendix

Specifications	92
Dell technical support policy	102
Contacting Dell	103
Warranty and return policy	104
Copyright	105



1. Introduction

This chapter provides information you need to know before using the machine.

- **Key benefits** 5
- **Features** 6
- **Useful to know** 8
- **About this user's guide** 9
- **Safety information** 10
- **Machine overview** 15
- **Control panel overview** 18
- **Turning on the machine** 20
- **Installing the driver locally** 21
- **Reinstalling the driver** 23

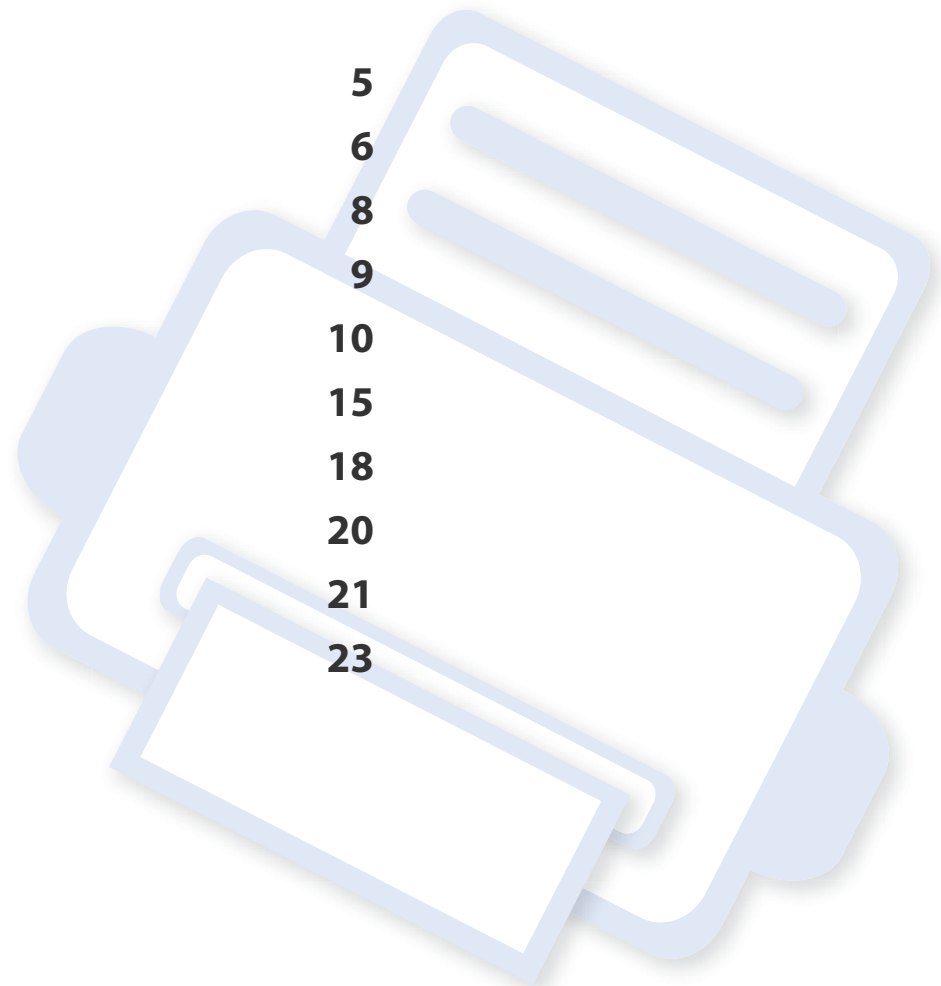

Key benefits

Environmentally friendly



- To save toner and paper, this machine supports Eco feature.
- To save paper, you can print multiple pages on one single sheet of paper (see "Using advanced print features" on page 155).
- To save paper, you can print on both sides of the paper (double-sided printing) (see "Using advanced print features" on page 155).
- To save electricity, this machine automatically conserves electricity by substantially reducing power consumption when not in use.

Fast high resolution printing



- You can print with a resolution of up to 1,200 x 1,200 dpi effective output.
- Fast, on-demand printing.
 - For single-side printing, 28 ppm (A4) or 29 ppm (Letter).
 - For duplex printing, 14 ppm (A4) or 15 ppm (Letter).

Convenience



- You can print on the go from your smartphone or computer using Google Cloud Print™ enabled apps (see "Google Cloud Print™" on page 130).
- Dell Printer Manager and Dell Printer Status Monitor are a program that monitors and informs you of the machine's status and allows you to customize the machine's settings.
- You can access Dell Support at www.dell.com or support.dell.com. Select your region on the WELCOME TO DELL SUPPORT page, and fill in the requested details to access help tools and information.

Wide range of functionality and application support



- Supports various paper sizes (see "Print media specifications" on page 94).
- Print watermark: You can customize your documents with words, such as "Confidential" (see "Using advanced print features" on page 155).
- Print posters: The text and pictures of each page of your document are magnified and printed across the multiple sheets of paper and can then be taped together to form a poster (see "Using advanced print features" on page 155).
- You can print in various operating systems (see "System requirements" on page 97).
- Your machine is equipped with a USB interface and/or a network interface.

Features

Features by model include:

Operating System

Operating System	B1265dnf
Windows	•
Macintosh	•
Linux	•
Unix	•

(•: supported)

Software

Software	B1265dnf	
PCL / SPL printer driver	•	
XPS printer driver	•	
Dell Printer Manager	Scan to PC settings	•
	Fax to PC settings	•
	Device settings	•
Dell Supplies Ordering Utility	•	

Software	B1265dnf	
Firmware Download Utility	•	
Dell Printer Status	•	
Embedded Web Service	•	
Fax	Dell Network PC Fax	•
Scan	Twain scan driver	•
	WIA scan driver	•
	Dell Scan Assistant	•
	SmarThru Office	•

(•: supported)

Features

Variety feature

Features		B1265dnf
Hi-Speed USB 2.0		•
Network Interface Ethernet 10/100 Base TX wired LAN		•
Eco printing		•
Duplex (2-sided) printing (Manual)		•
Automatic Document Feeder (ADF)		•
Google Cloud Print™		•
Fax	Multi-send	•
	Delay send	•
	Priority send	•
	Secure receive	•
	Duplex print	•
	Send/ Receive forward - fax	•
Scan	Scan to PC	•

Features		B1265dnf
Copy	ID card copying	•
	Collation	•
	Poster	•
	Clone	•
Copy (Continue)	2-up/ 4-up	•
	Adjust background	•
	Duplex copy	•

(●: supported)

Useful to know



The machine does not print.

- Open the print queue list and remove the document from the list (see "Canceling a print job" on page 46).
- Remove the driver and install it again (see "Installing the driver locally" on page 21).
- Select your machine as your default machine in your Windows.



Where can I purchase accessories or supplies?

- Inquire at a Dell distributor or your retailer.
- Visit **www.support.dell.com**. Select your country/region to view product service information.



The status LED flashes or remains constantly on.

- Turn the product off and on again.
- Check the meanings of LED indications in this manual and troubleshoot accordingly (see "Understanding the status LED" on page 85).



A paper jam has occurred.

- Open and close the front door.
- Check the instructions on removing jammed paper in this manual and troubleshoot accordingly (see "Clearing paper jams" on page 80).



Printouts are blurry.

- The toner level might be low or uneven. Shake the toner cartridge.
- Try a different print resolution setting.
- Replace the toner cartridge.



Where can I download the machine's driver?

- Visit **www.support.dell.com** to download the latest machine's driver, and install it on your system.

About this user's guide

This user's guide provides information for your basic understanding of the machine as well as detailed steps to explain machine usage.



- Read the safety information before using the machine.
- If you have a problem using the machine, refer to the troubleshooting chapter.
- Terms used in this user's guide are explained in the glossary chapter.
- All illustrations in this user's guide may differ from your machine depending on its options or model you purchased.
- The screenshots in this administrator's guide may differ from your machine depending on the machine's firmware/driver version.
- The procedures in this user's guide are mainly based on Windows 7.

Conventions

Some terms in this guide are used interchangeably, as below:

- Document is synonymous with original.
- Paper is synonymous with media, or print media.
- Machine refers to printer or MFP.

General icons



Icon	Text	Description
	Caution	Gives users information to protect the machine from possible mechanical damage or malfunction.
	Note	Provides additional information or detailed specification of the machine function and feature.

Safety information

These warnings and precautions are included to prevent injury to you and others, and to prevent any potential damage to your machine. Be sure to read and understand all of these instructions before using the machine. After reading this section, keep it in a safe place for future reference.

Important safety symbols

Explanation of all icons and signs used in this chapter

	Warning	Hazards or unsafe practices that may result in severe personal injury or death.
	Caution	Hazards or unsafe practices that may result in minor personal injury or property damage.
		Do not attempt.

Operating environment

Warning



Do not use if the power cord is damaged or if the electrical outlet is not grounded.

This could result in electric shock or fire.



Do not place anything on top of the machine (water, small metal or heavy objects, candles, lit cigarettes, etc.).

This could result in electric shock or fire.

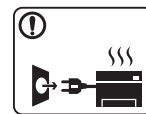

- If the machine gets overheated, it releases smoke, makes strange noises, or generates an odd odor, immediately turn off the power switch and unplug the machine.

- The user should be able to access the power outlet in case of emergencies that might require the user to pull the plug out.

This could result in electric shock or fire.



Do not bend, or place heavy objects on the power cord.

Stepping on or allowing the power cord to be crushed by a heavy object could result in electric shock or fire.







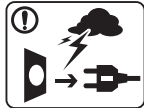

Do not remove the plug by pulling on the cord; do not handle the plug with wet hands.

This could result in electric shock or fire.







Safety information

Caution



	<p>During an electrical storm or for a period of non-operation, remove the power plug from the electrical outlet.</p> <p>This could result in electric shock or fire.</p>
	<p>Be careful, the paper output area is hot.</p> <p>Burns could occur.</p>
	<p>If the machine has been dropped, or if the cabinet appears damaged, unplug the machine from all interface connections and request assistance from qualified service personnel.</p> <p>Otherwise, this could result in electric shock or fire.</p>
	<p>If the machine does not operate properly after these instructions have been followed, unplug the machine from all interface connections and request assistance from qualified service personnel.</p> <p>Otherwise, this could result in electric shock or fire.</p>
	<p>If the plug does not easily enter the electrical outlet, do not attempt to force it in.</p> <p>Call an electrician to change the electrical outlet, or this could result in electric shock.</p>
	<p>Do not allow pets to chew on the AC power, telephone or PC interface cords.</p> <p>This could result in electric shock or fire and/or injury to your pet.</p>

Operating method

Caution

	<p>Do not forcefully pull the paper out during printing.</p> <p>It can cause damage to the machine.</p>
	<p>Be careful not to put your hand between the machine and paper tray.</p> <p>You may get injured.</p>
	<p>This machine's power reception device is the power cord.</p> <p>To switch off the power supply, remove the power cord from the electrical outlet.</p>
	<p>Be care when replacing paper or removing jammed paper.</p> <p>New paper has sharp edges and can cause painful cuts.</p>
	<p>When printing large quantities, the bottom part of the paper output area may get hot. Do not allow children to touch.</p> <p>Burns can occur.</p>
	<p>When removing jammed paper, do not use tweezers or sharp metal objects.</p> <p>It can damage the machine.</p>

Safety information





	Do not allow too many papers to stack up in the paper output tray. It can damage the machine.
	Do not block or push objects into the ventilation opening. This could result in elevated component temperatures which can cause damage or fire.
	Use of controls or adjustments or performance of procedures other than those specified herein may result in hazardous radiation exposure.

Installation / Moving





Warning

	Do not place the machine in an area with dust, humidity, or water leaks. This could result in electric shock or fire.
--	--

Caution

	<p>Before moving the machine, turn the power off and disconnect all cords. The information below are only suggestions based on the units weight.</p> <p>If you have a medical condition that prevents you from lifting, do not lift the machine. Ask for help, and always use the appropriate amount of people to left the device safety.</p> <p>Then lift the machine:</p> <ul style="list-style-type: none">• If the machine weighs under 20 kg (44.09 lbs), lift with 1 person.• If the machine weighs 20 kg (44.09 lbs) - 40kg (88.18 lbs), lift with 2 people.• If the machine weighs more than 40 kg (88.18 lbs), lift with 4 or more people. <p>The machine could fall, causing injury or machine damage.</p>
	Do not place the machine on an unstable surface. The machine could fall, causing injury or machine damage.
	Use only No.26 AWG ^a or larger, telephone line cord, if necessary. Otherwise, it can cause damage to the machine.
	Make sure you plug the power cord into a grounded electrical outlet. Otherwise, this could result in electric shock or fire.





Safety information

	<p>Use the power cord supplied with your machine for safe operation. If you are using a cord which is longer than 2 meters (6 feet) with a 110V machine, then the gauge should be 16 AWG or larger.</p> <p>Otherwise, it can cause damage to the machine, and could result in electric shock or fire.</p>
	<p>The machine should be connected to the power level which is specified on the label.</p> <p>If you are unsure and want to check the power level you are using, contact the electrical utility company.</p>
	<p>Do not put a cover over the machine or place it in an airtight location, such as a closet.</p> <p>If the machine is not well-ventilated, this could result in fire.</p>
	<p>Do not overload wall outlets and extension cords.</p> <p>This can diminish performance, and could result in electric shock or fire.</p>



a. AWG: American Wire Gauge

Maintenance / Checking

Caution



	<p>Unplug this product from the wall outlet before cleaning the inside of the machine. Do not clean the machine with benzene, paint thinner or alcohol; do not spray water directly into the machine.</p> <p>This could result in electric shock or fire.</p>
	<p>When you are working inside the machine replacing supplies or cleaning the inside, do not operate the machine.</p> <p>You could get injured.</p>
	<p>Keep cleaning supplies away from children.</p> <p>Children could get hurt.</p>
	<p>Do not disassemble, repair or rebuild the machine by yourself.</p> <p>It can damage the machine. Call a certified technician when the machine needs repairing.</p>
	<p>Keep the power cable and the contact surface of the plug clean from dust or water.</p> <p>Otherwise, this could result in electric shock or fire.</p>





Safety information

	<p>To clean and operate the machine, strictly follow the user's guide provided with the machine.</p> <p>Otherwise, you could damage the machine.</p>
	<ul style="list-style-type: none">Do not remove any covers or guards that are fastened with screws.Fuser units should only be repaired by a certified service technician. Repair by non-certified technicians could result in fire or electric shock.The machine should only be repaired by a Dell service technician.

Supply usage

Caution

	<p>Do not disassemble the toner cartridge.</p> <p>Toner dust can be dangerous if inhaled or ingested.</p>
	<p>Do not burn any of the supplies such as toner cartridge or fuser unit.</p> <p>This could cause an explosion or uncontrollable fire.</p>

	<p>When storing supplies such as toner cartridges, keep them away from children.</p> <p>Toner dust can be dangerous if inhaled or ingested.</p>
	<p>When changing the toner cartridge or removing jammed paper, be careful not to let toner dust touch your body or clothes.</p> <p>Toner dust can be dangerous if inhaled or ingested.</p>
	<p>When toner gets on your clothing, do not use hot water to wash it.</p> <p>Hot water sets toner into fabric. Use cold water.</p>
	<p>Using recycled supplies, such as toner, can cause damage to the machine.</p> <p>In case of damage due to the use of recycled supplies, a service fee will be charged.</p>

Machine overview

Accessories

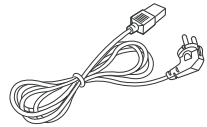

Power cord



Quick installation guide



Software CD^a

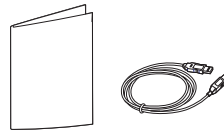

Misc. accessories^b

a. The software CD contains the print drivers and software applications.

b. Miscellaneous accessories included with your machine may vary by country of purchase and specific model.

Machine overview

Front view

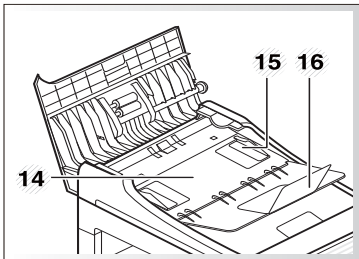
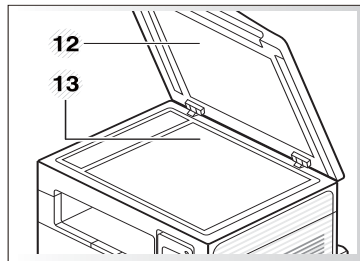
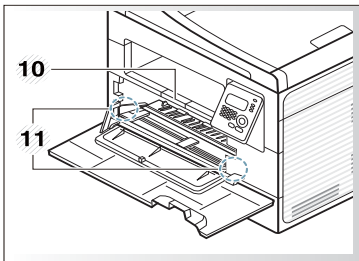
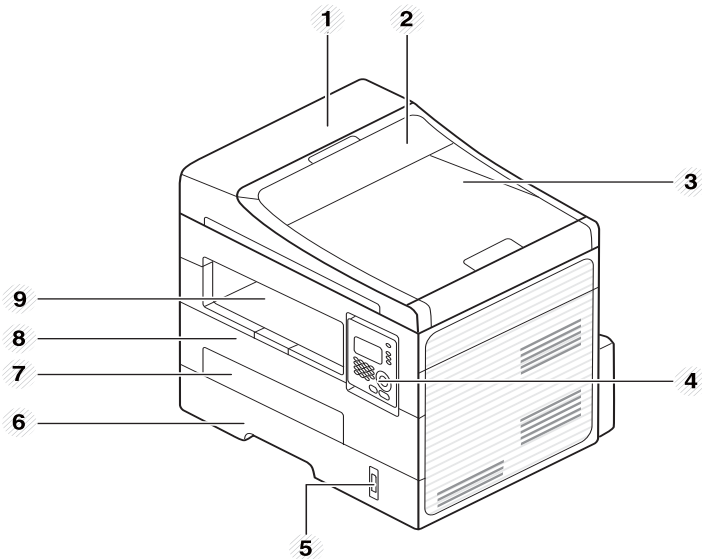

1	Document feeder cover	9	Output tray
2	Document feeder guide cover	10	Output support
3	Document feeder output tray	11	Paper width guide on a manual feeder
4	Control Panel	12	Scanner lid
5	Paper level indicator	13	Scanner glass
6	Tray	14	Document feeder input tray
7	Manual feeder tray	15	Paper width guide on a document feeder
8	Front cover	16	Document feeder output support

Machine overview

Rear view

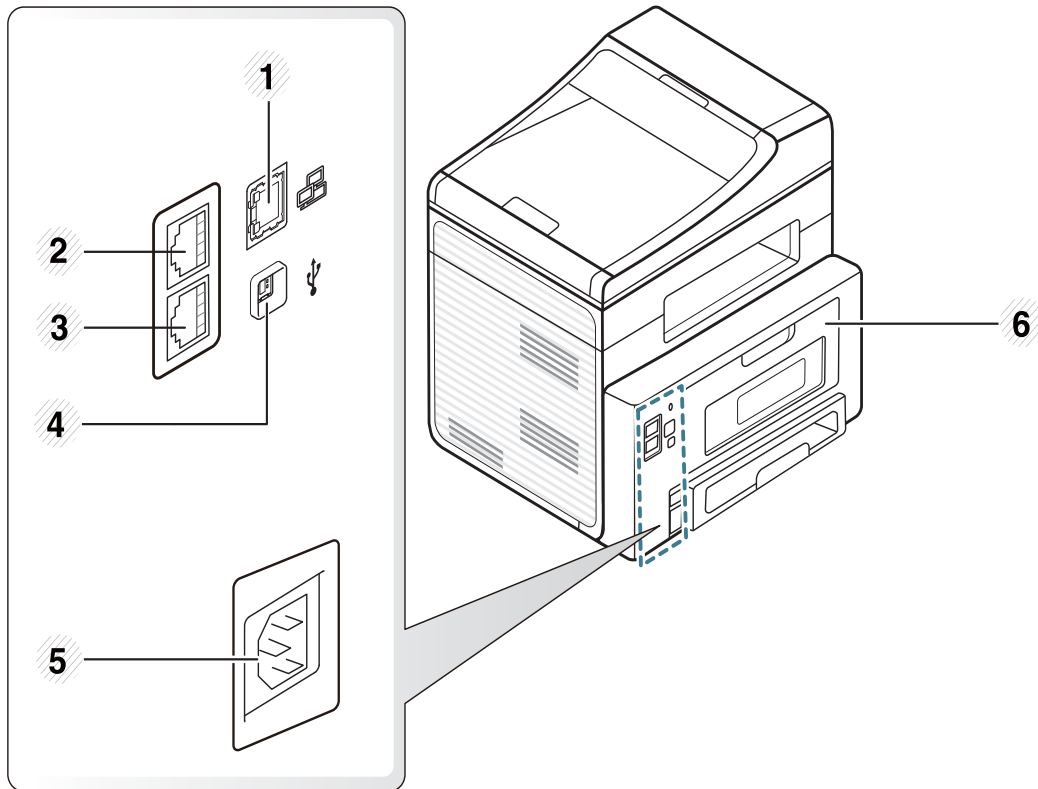

1	Network port	4	USB port
2	Extension telephone socket (EXT)	5	Power receptacle
3	Telephone line socket (Line)	6	Rear cover

Control panel overview



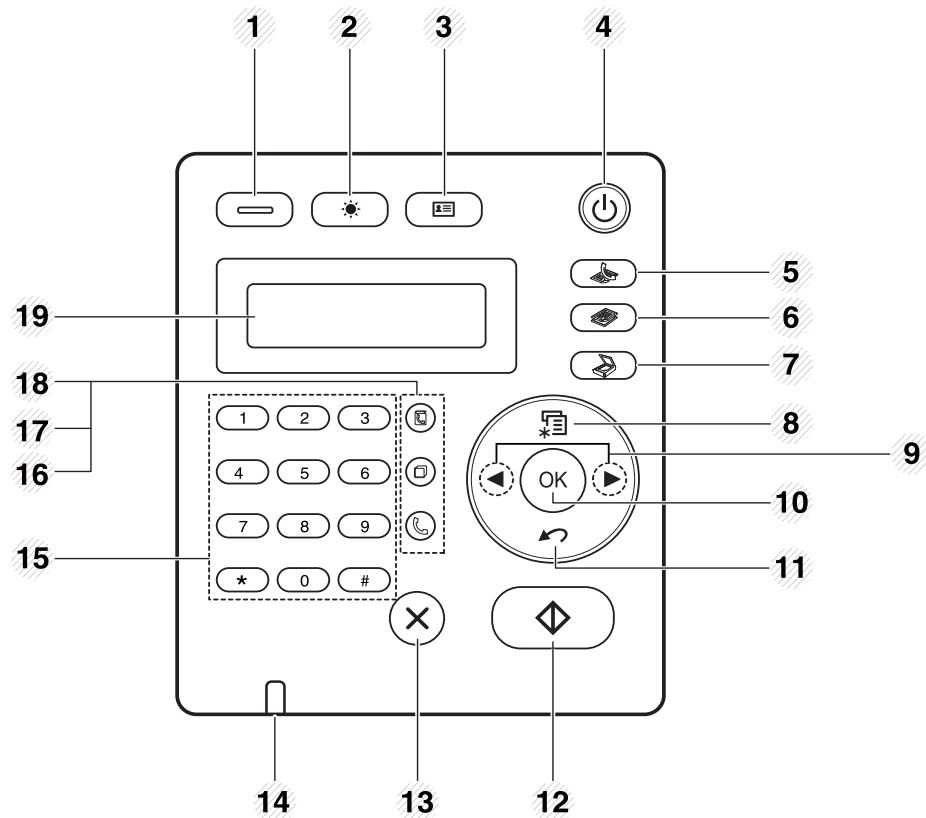

Control panel



1		Eco	Turn into eco mode to reduce toner consumption and paper usage (see "Eco printing" on page 48).
---	--	------------	---

2		Darkness	Adjust the brightness level to make a copy for easier reading, when the original contains faint markings and dark images.
3		ID Copy	Allows you to copy both sides of an ID card like a driver's license on a single side of paper (see "ID card copying" on page 53).
4		Power	Turns the power on or off, or wakes up the machine from the power save mode. If you need to turn the machine off, press this button for more than three seconds.
5		Fax	Switches to Fax mode.
6		Copy	Switches to Copy mode.
7		Scan	Switches to Scan mode.
8		Menu	Opens Menu mode and scrolls through the available menus.
9	Left/Right Arrows		Scrolls through the options available in the selected menu and increases or decreases values.
10	OK		Confirms the selection on the screen.
11		Back	Sends you back to the upper menu level.
12		Start	Starts a job.

Control panel overview

13		Stop/Clear	Stops an operations at any time.
14	Status LED		Indicates the status of your machine (see "Understanding the status LED" on page 85).
15	Numeric keypad		Dials a number or enters alphanumeric characters.
16		On Hook Dial	When you press this button, you can hear a dial tone. Then enter a fax number. It is similar to making a call using speaker phone.
17		Redial/ Pause	Redials the last number in ready mode, or inserts a pause(-) into a fax number in edit mode.
18		Address Book	Allows you to store frequently used fax numbers or search for stored fax numbers.
19	Display screen		Shows the current status and displays prompts during an operation.

Adjusting the control panel

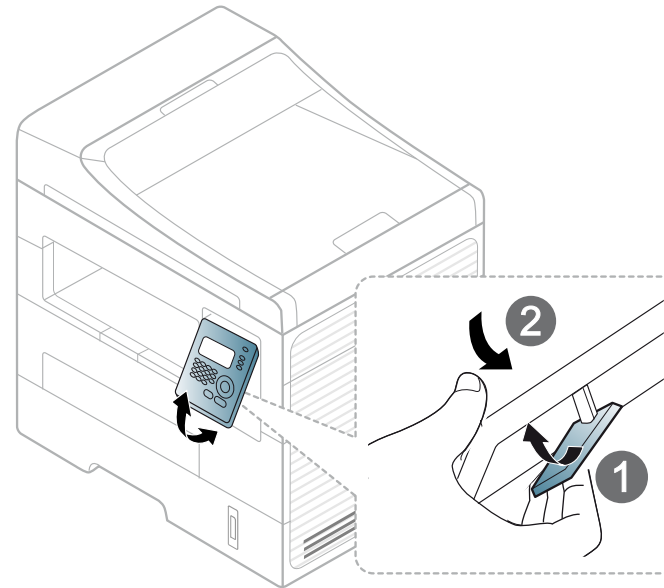

Turning on the machine

Connect the machine to the electricity supply first.

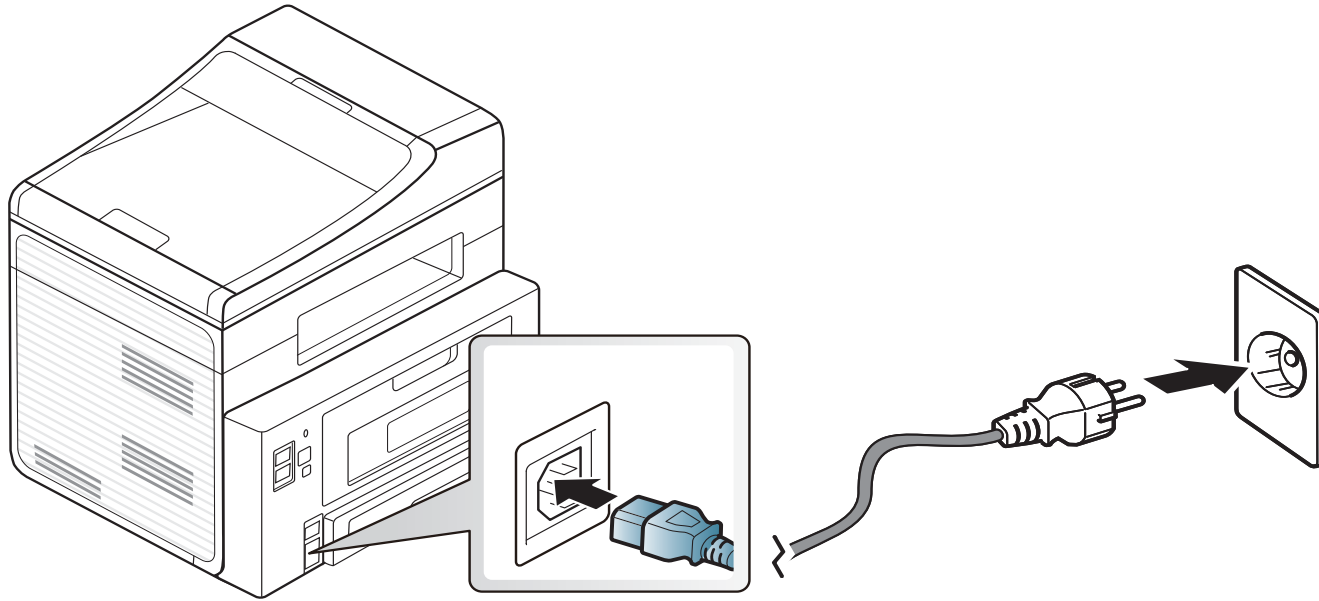

Installing the driver locally

A locally connected machine is a machine directly attached to your computer using the cable. If your machine is attached to a network, skip the following steps below and go on to installing a network connected machine's driver (see "Installing driver over the network" on page 120).



- If you are a Macintosh, Linux, or Unix OS user, refer to the "Software Installation" on page 109.
- The installation window in this User's Guide may differ depending on the machine and interface in use.
- Selecting **Custom Installation** allows you to choose which programs to install.
- Only use a USB cable no longer than 3 meters (118 inches).

Windows

- 1 Make sure that the machine is connected to your computer and powered on.



If the "**Found New Hardware Wizard**" appears during the installation procedure, click **Cancel** to close the window.

- 2 Insert the supplied software CD into your CD-ROM drive.

The software CD should automatically run and an installation window will appear.

If the installation window does not appear, click **Start > All programs > Accessories > Run**.

X:\Setup.exe replacing "X" with the letter, which represents your CD-ROM drive and click **OK**.

- 3 Select **Next**.

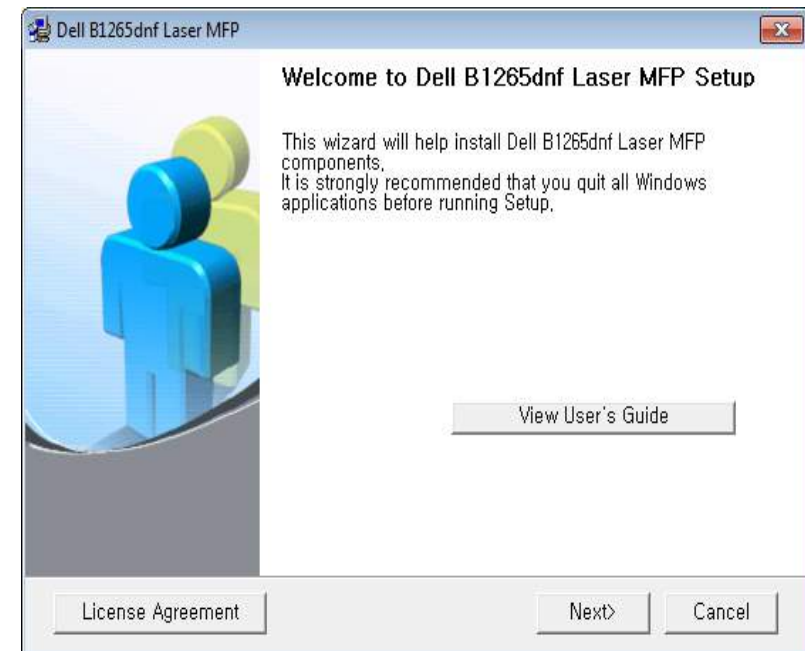

Installing the driver locally

- 4 Select **Connect to the computer using USB cable**. Click **Next**.

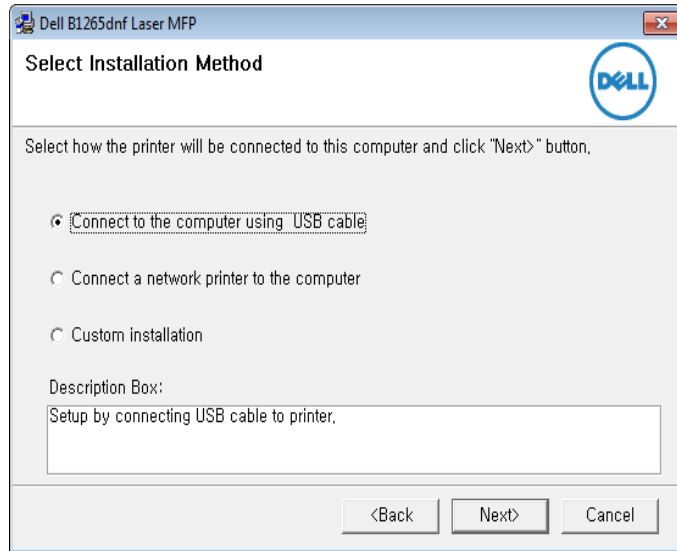

- 5 Follow the instructions in the installation window.

Reinstalling the driver

If the printer driver does not work properly, follow the steps below to reinstall the driver.

Windows

- 1 Make sure that the machine is connected to your computer and powered on.
- 2 From the **Start** menu, select **Programs** or **All Programs** > **Dell** > **Dell Printers** > **your printer driver name** > **Maintenance**.
- 3 Select **Repair** and click **Next**.
- 4 Insert the software CD into your CD-ROM drive and install the driver again (see "Installing the driver locally" on page 21).



2. Menu overview and basic setup

This chapter provides information about the overall menu structure and the basic setup options.

- **Menu overview** 25
- **Changing the display language** 30
- **Media and tray** 31
- **Basic printing** 45
- **Basic copying** 51
- **Basic scanning** 55
- **Basic faxing** 56



Menu overview

The control panel provides access to various menus to set up the machine or use the machine's functions.



- An asterisk (*) appears next to the currently selected menu.
- Some menus may not appear on the display depending on options. If so, it is not applicable to your machine.
- Some menu names may differ from your machine depending on its options.

Accessing the menu

- 1 Select the Fax, Copy, or Scan button on the control panel depending on the feature to be used.
- 2 Select  (**Menu**) until the menu you want appears on the bottom line of the display and press **OK**.
- 3 Press the left/right arrows until the needed menu item appears and press **OK**.
- 4 If the setting item has sub menus, repeat step 3.
- 5 Press the left/right arrows to access the required value.
- 6 Press **OK** to save the selection.

- 7 Press  (**Stop/Clear**) to return to the ready mode.

Items	Options	
Fax Feature	Darkness	Light+5- Light+1 Normal Dark+1- Dark+5
	Contrast	Light+5- Light+1 Normal Dark+1- Dark+5
	Resolution	Standard Fine Super Fine Photo Fax Color Fax
	Scan Size	
	Multi Send	
	Delay Send	
Fax Feature	Priority Send	
	Forward	Fax PC
	Secure Receive	On Off Print
	Add Page	
	Cancel Job	

Menu overview

Items	Options	
Fax Setup	Sending	Redial Times
		Redial Term
		Prefix Dial
		ECM Mode
		Send Report
		Image TCR
		Dial Mode ^a
Fax Setup	Receiving	Receive Mode
		Ring To Answer
		Stamp RCV Name
		RCV Start Code
		Auto Reduction
		Discard Size
		Junk Fax Setup
		DRPD Mode
	Duplex Print	
	Change Default	Resolution
Darkness		
Auto Report	Contrast	
	Scan Size	
	On	
	Off	

Items	Options	
Copy Feature	Scan Size	
	Reduce/Enlarge	
	Darkness	Light+5- Light+1 Normal Dark+1- Dark+5

Menu overview

Items	Options	
Copy Feature	Contrast	Light+5- Light+1
		Normal
		Dark+1- Dark+5
	Original Type	Text
		Text/Photo
		Photo
Layout	Normal	2-Up
		4-Up
		ID copy
		Poster Copy
		Clone Copy
Adjust Bkgd.	Off	Auto
		Enhance Lev.1
		Enhance Lev.2
		Erase Lev.1- Erase Lev.4
Duplex	Off	1 -> 2 Side Long
		1 -> 2 SideShort

Items	Options		
Copy Setup	Change Default	Scan Size	
		Copies	
		Copy Collation	
		Reduce/Enlarge	
		Duplex	
		Darkness	
		Contrast	
		Original Type	
		Adjust Bkgd.	
Print Setup	Orientation	Portrait	
		Landscape	
	Duplex	Off	1 -> 2 Side Long
			1 -> 2 SideShort
	Copies	[1-999]:1	
	Resolution	600dpi-Normal	1200dpi-Best
Darkness	Normal	Light	
		Dark	

Menu overview

Items	Options	
Print Setup	Clear Text	Off
		Minimum
	Medium	
	Maximum	
	Auto CR	LF
		LF+CR
	Emulation	Emulation Type
		Setup

Items	Options		
System Setup	Machine Setup	Machine ID	
		Fax Number	
Date & Time			
Clock Mode			
Language			
Power Save			
Wakeup Event			
System Timeout			
Job Timeout			
Altitude Adj.			
Auto Continue ^b			
Paper Mismatch			
Paper Substit ^b			
PrintBlankPage			
Toner Save			
Eco Settings			
		Paper Setup	Paper Size
			Paper Type
			Paper Source
		Margin	

Menu overview

Items	Options	
System Setup	Sound/Volume	Key Sound
		Alarm Sound
		Speaker
Ringer		
Report	All Report	Configuration
		Supplies Info.
		Address Book
		Fax Send
		Fax Sent
		Fax Received
		Schedule Jobs
		Junk Fax
		Network Conf.
		Usage Counter
		Fax Options
		Maintenance
Serial NO.		
TonerLow Alert		

Items	Options	
System Setup	Clear Setting	All Settings
		Print Setup
		Fax Setup
		Copy Setup
		System Setup
		Network Setup
		Address Book
		Fax Sent
		Fax Received
		Network
BOOTP		
Static		
TCP/IP (IPv6)	IPv6 Activate	
	DHCPv6 Config	
Ethernet Speed	Automatic	
	10Mbps Half	
	10Mbps Full	
	100Mbps Half	
	100Mbps Full	
	Clear Setting	
	Network Conf.	

a. This setting may not be available depending on your country.

b. This option only appears if "paper mismatch" is enabled.

c. This option only appears when small amount of toner is left in the cartridge.

Changing the display language

To change the language that is displayed on the control panel, follow these steps:

- 1 Select  **(Menu)** > **System Setup** > **Machine Setup** > **Language** on the control panel.



It may be necessary to press **OK** to navigate to lower-level menus.

- 2 Select the language you want to display on the control panel.
- 3 Press **OK** to save the selection.

Media and tray

This chapter provides information on how to load print media into your machine.



- Using print media that does not meet these specifications may cause problems or require repairs. Such repairs are not covered by Dell's warranty or service agreements.
- Make sure not to use the inkjet photo paper with this machine. It could cause damage to the machine.
- Using inflammable print media can cause a fire.
- Use designated print media (see "Print media specifications" on page 94).



The use of inflammable media or foreign materials left in the printer may lead to overheating of the unit and, in rare cases may cause a fire.

Tray overview

To change the size, you need to adjust the paper guides.

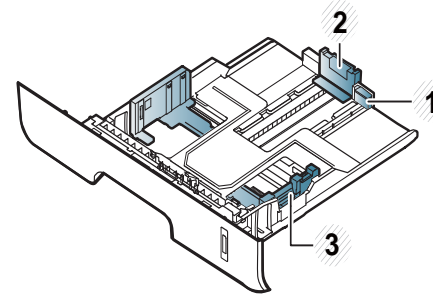

- 1 Tray extension guide
- 2 Paper length guide
- 3 Paper width guide



If you do not adjust the guide, it may cause paper registration, image skew, or jamming of the paper.

Media and tray



The paper quantity indicator shows the amount of paper in the tray.

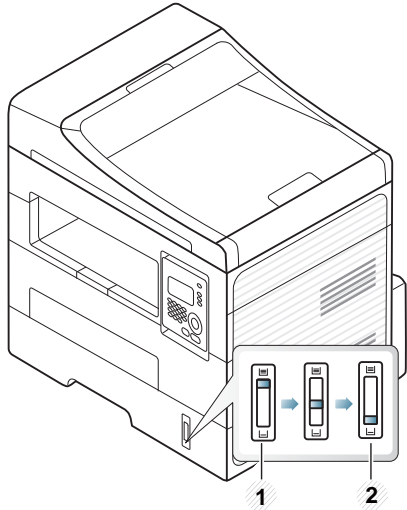

- 1 Full
- 2 Empty

Paper type available for duplex printing

Depending on the power voltage your machine uses, available paper types for duplex printing differs. Refer to the below table.

Power voltage	Available paper
110V	Letter, Legal, US Folio, Oficio
220V	A4

Media and tray

Loading paper in the tray



When printing using the tray, do not load paper on the manual feeder, it may cause a paper jam.

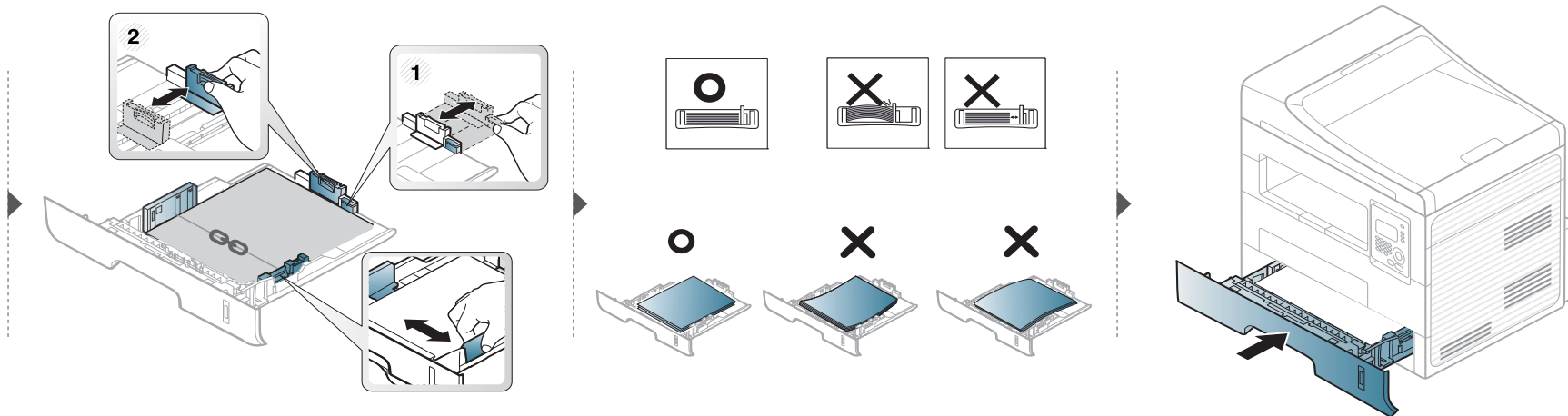
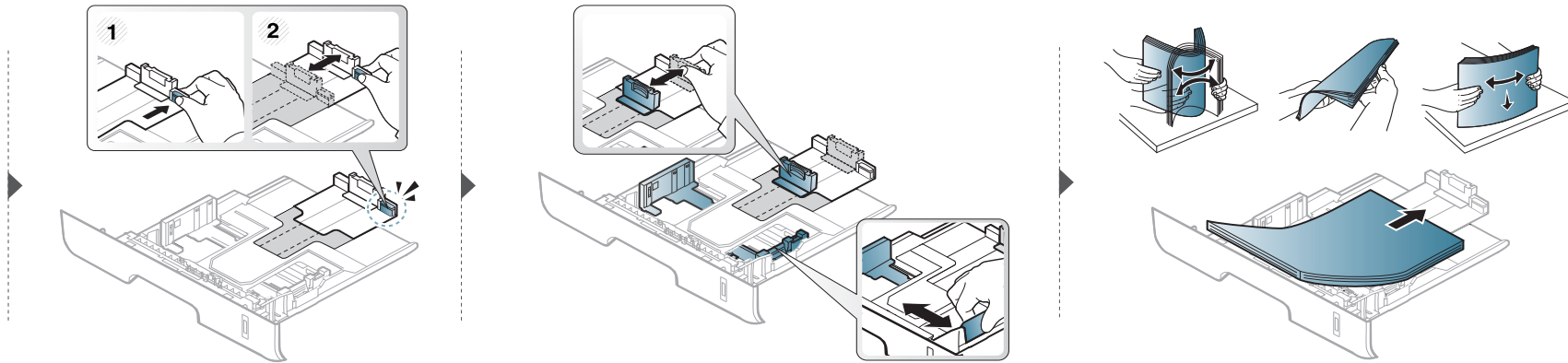

Media and tray

Loading in manual feeder

The manual feeder can hold special sizes and types of print material, such as postcards, note cards, and envelopes (see "Print media specifications" on page 94).



Tips on using the manual feeder

- Load only one type, size and weight of print media at time in the manual feeder.
- To prevent paper jams, do not add paper while printing when there is still paper in the manual feeder.
- Print media should be loaded face up with the top edge going into the manual feeder first and be placed in the center of the tray.
- To ensure printing quality and to prevent paper jams, only load the available paper (see "Print media specifications" on page 94).
- Flatten any curl on postcards, envelopes, and labels before loading them into the manual feeder.
- When printing on special media, you must follow the loading guidelines (see "Printing on special media" on page 36).
- When papers overlap when printing using the manual feeder, open tray and remove the papers then try printing again.
- When paper does not feed well while printing, push the paper in manually until it starts feeding automatically.
- When the machine is in a power save mode, the machine does not feed paper from the manual feeder. Wake up the machine by pressing the power button before using the manual feeder.

Media and tray

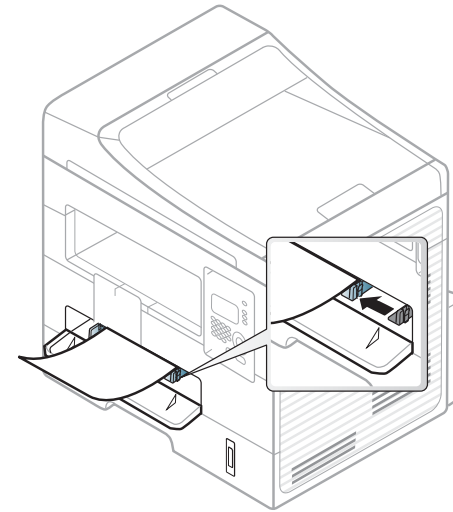
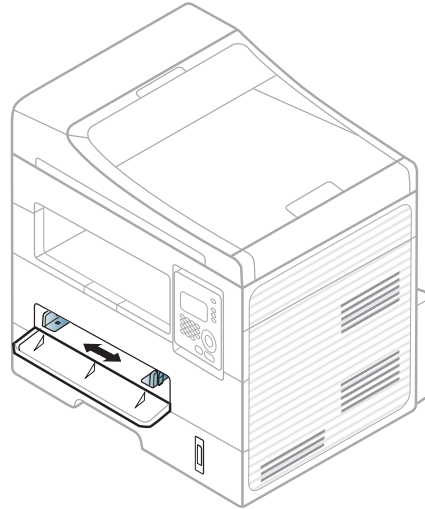
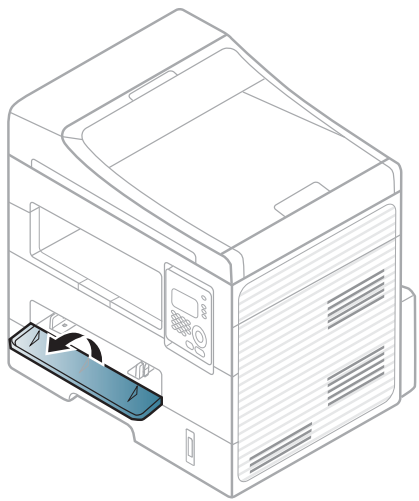

Media and tray

Printing on special media

The table below shows the special media usable in each tray.

The media is also shown in the **Printing Preferences**. To get the highest printing quality, select the proper media type from the **Printing preferences** window > **Paper** tab > **Paper Type** (see "Opening printing preferences" on page 47).

For example, if you want to print on labels, select **Labels** for **Paper Type**.



- When using special media, we recommend you feed one sheet at a time (see "Print media specifications" on page 94).
- **Printing the special media (Face up)**
If special media are printed out with curl, wrinkles, crease, or black bold lines, open the rear cover and try printing again. Keep the rear cover opened during printing.

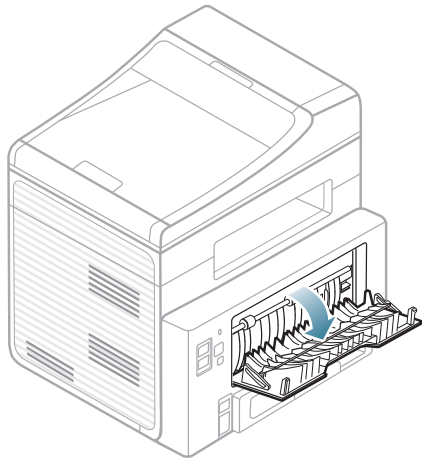

To see for paper weights for each sheet, refer to "Print media specifications" on page 94.

Types	Tray	Manual feeder
Plain	•	•
Thick	•	•
Thicker		•
Thin	•	•
Bond	•	•
Color		•
CardStock	•	•
Labels		•
Transparency		•
Envelope		•
Thick Envelope		•
Preprinted		•
Cotton		•
Recycled	•	•
Archive	•	•

(•: supported, Blank: Not available)

Media and tray

Envelope

Printing successfully on envelopes depends upon the quality of the envelopes.

To print an envelope, place it as shown in the following figure.

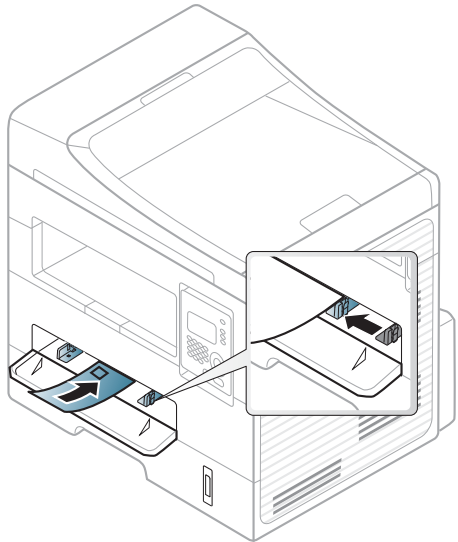

If envelopes are printed out with wrinkles, creases, or black bold lines, open the rear cover and try printing again. Keep the rear cover opened during printing.

- When selecting envelopes, consider the following factors:
 - **Weight:** should not exceed 90 g/m² otherwise; jams may occur.
 - **Construction:** should lie flat with less than 6 mm curl and should not contain air.
 - **Condition:** should not be wrinkled, nicked, nor damaged.
 - **Temperature:** should resist the heat and pressure of the machine during operation.

- Use only well-constructed envelopes with sharp and well-creased folds.
- Do not use stamped envelopes.
- Do not use envelopes with clasps, snaps, windows, coated lining, self-adhesive seals, or other synthetic materials.
- Do not use damaged or poorly made envelopes.
- Be sure the seam at both ends of the envelope extends all the way to the corner of the envelope.

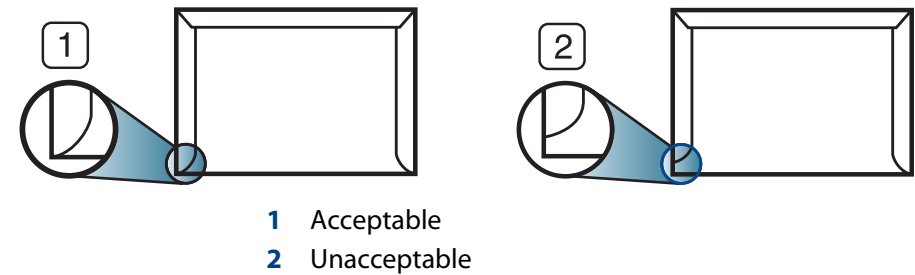

- Envelopes with a peel-off adhesive strip or with more than one flap that folds over to seal must use adhesives compatible with the machine's fusing temperature for 0.1 second about 170°C (338 °F). The extra flaps and strips might cause wrinkling, creasing, or jams, and may even damage the fuser.
- For the best print quality, position margins no closer than 15 mm from the edges of the envelope.
- Avoid printing over the area where the envelope's seams meet.

Media and tray

Transparency

To avoid damaging the machine, use only transparencies designed for use in laser printers.

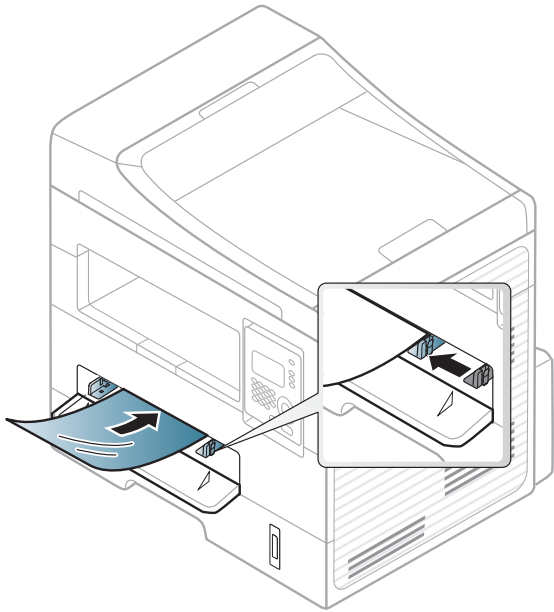

- Do not use transparencies that separate from the backing sheet.
- To prevent transparencies from sticking to each other, do not let the printed sheets stack up as they are being printed out.
- Recommended media: Transparency for a color laser printer by Xerox, such as 3R 91331(A4), 3R 2780 (Letter)

- Must withstand the machine's fusing temperature.
- Place them on a flat surface after removing them from the machine.
- Do not leave unused transparencies in the paper tray for long. Dust and dirt may accumulate on them, resulting in spotty printing.
- To avoid smudging caused by fingerprints, handle them carefully.
- To avoid fading, do not expose printed transparencies to prolonged sunlight.
- Ensure that transparencies are not wrinkled, curled, or have any torn edges.

Media and tray

Labels

To avoid damaging the machine, use only labels designed for use in laser printers.

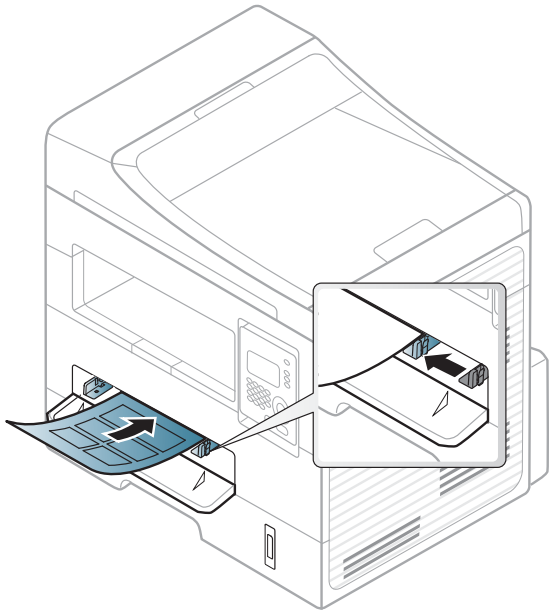

- When selecting labels, consider the following factors:
 - **Adhesives:** Should be stable at your machine's fusing temperature. Check your machine's specifications to view the fusing temperature (about 170°C (338°F)).
 - **Arrangement:** Only use labels with no exposed backing between them. Labels can peel off sheets that have spaces between the labels, causing serious jams.
 - **Curl:** Must lie flat with no more than 13 mm of curl in any direction.
- **Condition:** Do not use labels with wrinkles, bubbles, or other indications of separation.
- Make sure that there is no exposed adhesive material between labels. Exposed areas can cause labels to peel off during printing, which can cause paper jams. Exposed adhesive can also cause damage to machine components.
- Do not run a sheet of labels through the machine more than once. The adhesive backing is designed for only a single pass through the machine.
- Do not use labels that are separating from the backing sheet or are wrinkled, bubbled, or otherwise damaged.

Media and tray

Card stock/ Custom-sized paper

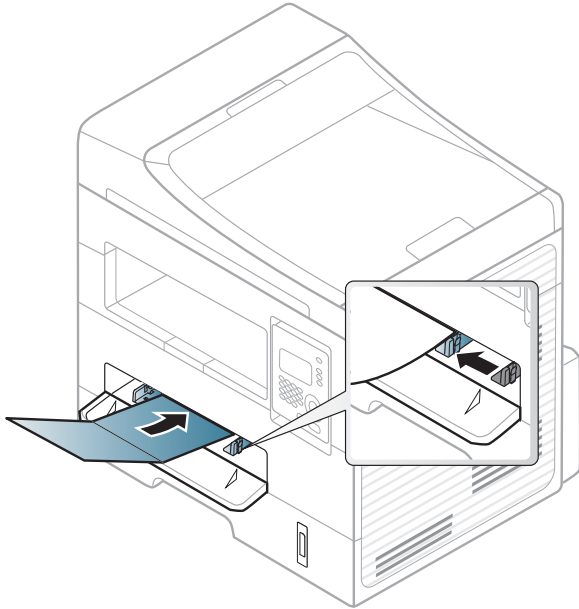

- In the software application, set the margins to at least 6.4 mm (0.25 inches) away from the edges of the material.

Preprinted paper

When loading preprinted paper, the printed side should be facing up with an uncurled edge at the front. If you experience problems with paper feeding, turn the paper around. Note that print quality is not guaranteed.

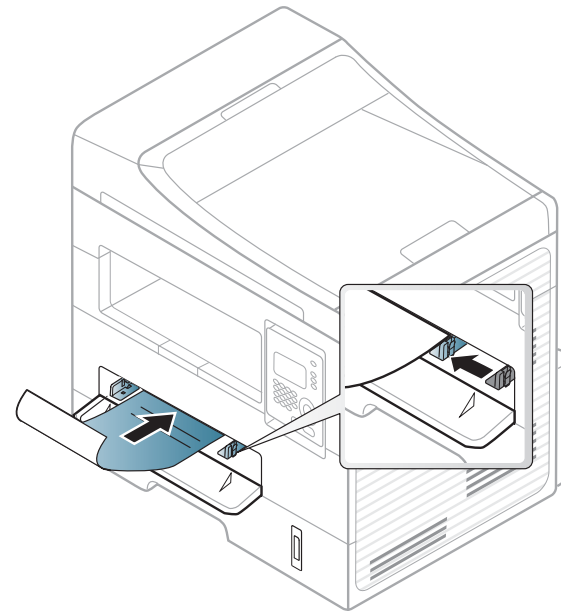

- Must be printed with heat-resistant ink that will not melt, vaporize, or release hazardous emissions when subjected to the machine's fusing temperature for 0.1 second (about 170°C (338°F)).
- Preprinted paper ink must be non-flammable and should not adversely affect machine rollers.
- Before you load preprinted paper, verify that the ink on the paper is dry. During the fusing process, wet ink can come off preprinted paper, reducing print quality.

Media and tray

Setting the paper size and type

After loading paper in the paper tray, set the paper size and type using the control panel buttons.



It may be necessary to press **OK** to navigate to lower-level menus for some models.

- 1 Select  **(Menu)** > **System Setup** > **Paper Setup** > **Paper Size** or **Paper Type** on the control panel.
- 2 Select the tray and the option you want.
- 3 Press **OK** to save the selection.



- The settings set from the machine driver override the settings on the control panel.
 - a To print from an application, open an application and start the print menu.
 - b Open **Printing Preferences** (see "Opening printing preferences" on page 47).
 - c Press the **Paper** tab and select an appropriate paper.
- If you want to use special-sized paper such as billing paper, select the **Paper** tab > **Size** > **Edit...** and set **Custom Paper Size Settings** in the **Printing Preferences** (see "Opening printing preferences" on page 47).

Preparing originals

- Do not load paper smaller than 142 x 148 mm (5.6 x 5.8 inches) or larger than 216 x 356 mm (8.5 x 14 inches).
- Do not attempt to load the following s of paper, in order to prevent paper jam, low print quality and machine damage.
 - Carbon-paper or carbon-backed paper
 - Coated paper
 - Onion skin or thin paper
 - Wrinkled or creased paper
 - Curled or rolled paper
 - Torn paper
- Remove all staples and paper clips before loading.
- Make sure any glue, ink, or correction fluid on the paper is completely dry before loading.
- Do not load originals that include different sizes or weights of paper.
- Do not load booklets, pamphlets, transparencies, or documents with other unusual characteristics.

Media and tray

Loading originals

You can use the scanner glass or the document feeder to load an original for copying, scanning, and sending a fax.

On the scanner glass

Using the scanner glass, you can copy or scan originals. You can get the best scan quality, especially for colored or gray-scaled images. Make sure that no originals are in the document feeder. If an original is detected in the document feeder, the machine gives it priority over the original on the scanner glass.

- 1 Lift and open the scanner lid.

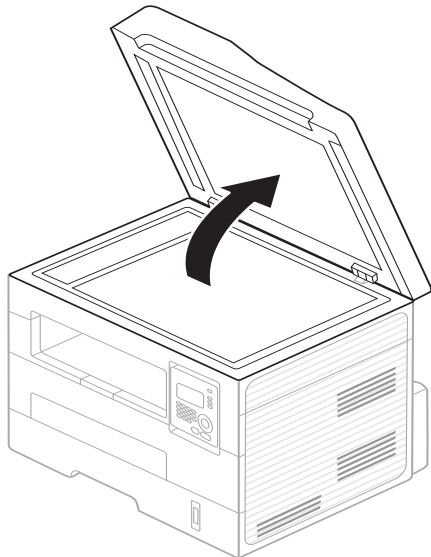

- 2 Place the original face down on the scanner glass. Align it with the registration guide at the top left corner of the glass.

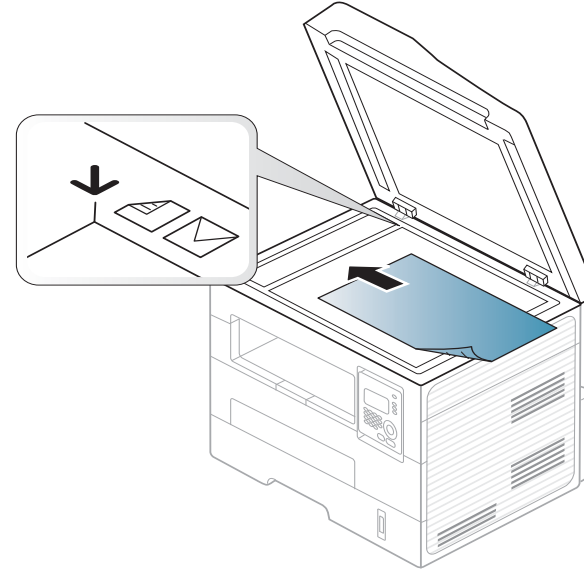

- 3 Close the scanner lid.



- Leaving the scanner lid open while copying may affect copy quality and toner consumption.
- Dust on the scanner glass may cause black spots on the printout. Always keep it clean (see "Cleaning the machine" on page 69).
- If you are copying a page from a book or magazine, lift the scanner lid until its hinges are caught by the stopper and then close the lid. If the book or magazine is thicker than 30 mm, start copying with the scanner lid open.

Media and tray



- Be careful not to break the scanner glass. You may get hurt.
- Do not put hands while closing the scanner lid. The scanner lid may fall on your hands and get hurt.
- Do not look the light from inside of the scanner while copying or scanning. It is harmful to eyes.

In the document feeder

Using the document feeder, you can load up to 40 sheets of paper (75 g/m², 20 lbs bond) for one job.

- 1 Flex or fan the edge of the paper stack to separate the pages before loading originals.

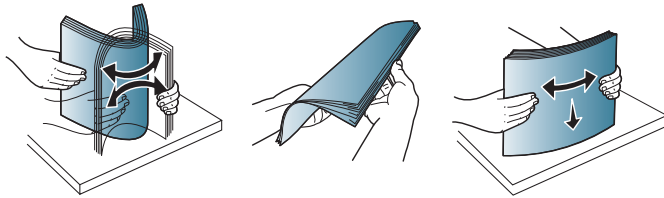

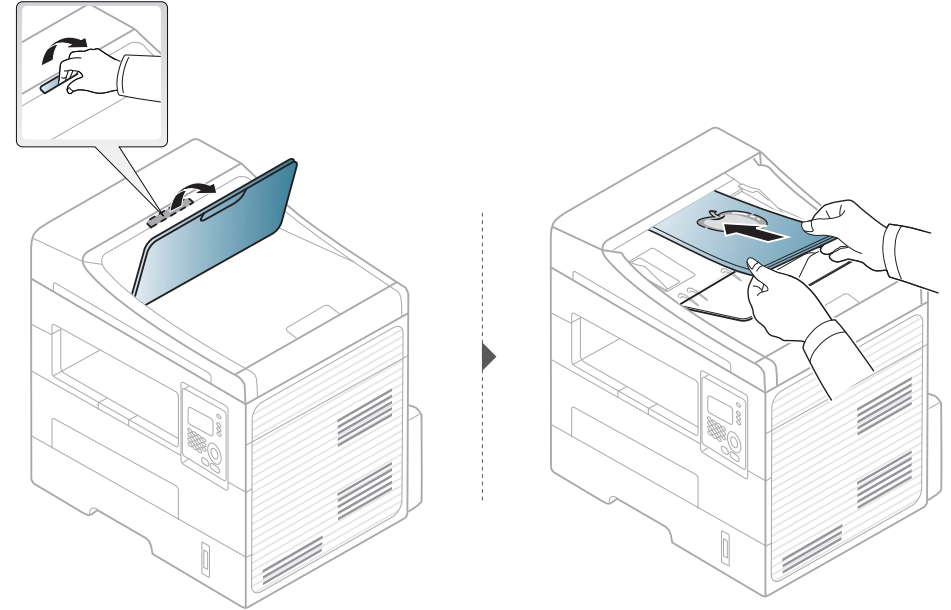

- 2 Load the original face up into the document feeder input tray. Make sure that the bottom of the original stack matches the paper size marked on the document input tray.

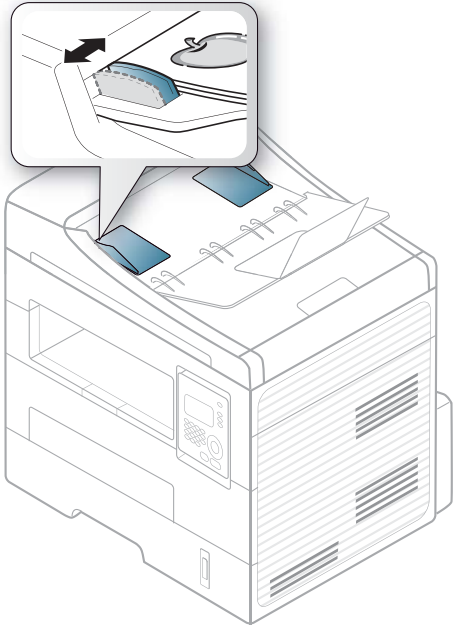

Media and tray

- 3 Adjust the document feeder width guides to the paper size.



- Dust on the document feeder glass may cause black lines on the printout. Always keep the glass clean (see "Cleaning the machine" on page 69).
- To print on both sides of the paper using the ADF, from the control panel press  **(Copy)** >  **(Menu)** > **Copy Feature** > **Duplex** > **1 -> 2 Side Long** or **1 -> 2 SideShort** and print on one side of the paper, then reload the sheet to print on the other side.

Basic printing



For special printing features, refer to the Advanced Guide (see "Using advanced print features" on page 155).

Printing



If you are a Macintosh or Linux user, refer to the "Macintosh printing" on page 161 or "Linux printing" on page 163.

The following **Printing Preferences** window is for Notepad in Windows 7.

- 1 Open the document you want to print.
- 2 Select **Print** from the **File** menu.

- 3 Select your machine from the **Select Printer** list.

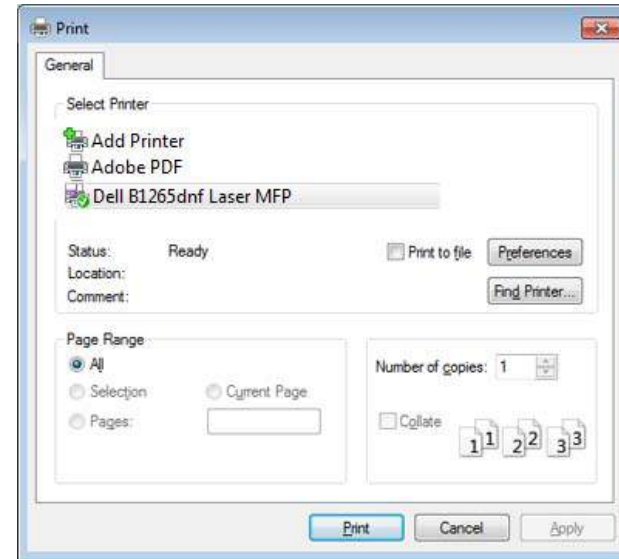

- 4 The basic print settings including the number of copies and print range are selected within the **Print** window.





To take advantage of the advanced printing features, click **Properties** or **Preferences** from the Print window (see "Opening printing preferences" on page 47).

- 5 To start the print job, click **OK** or **Print** in the **Print** window.

Basic printing

Canceling a print job





If the print job is waiting in the print queue or print spooler, cancel the job as follows:

- You can access this window by simply double-clicking the machine icon () in the Windows task bar.
- You can also cancel the current job by pressing  (**Stop/Clear**) on the control panel.

Basic printing

Opening printing preferences



- The **Printing Preferences** window that appears in this user's guide may differ depending on the machine in use.
- When you select an option in **Printing Preferences**, you may see a warning mark  or . An  mark means you can select that certain option but it is not recommended, and an  mark means you cannot select that option due to the machine's setting or environment.

- 1 Open the document you want to print.
- 2 Select **Print** from the file menu. The **Print** window appears.
- 3 Select your machine from the **Select Printer**.

4 Click **Properties** or **Preferences**.

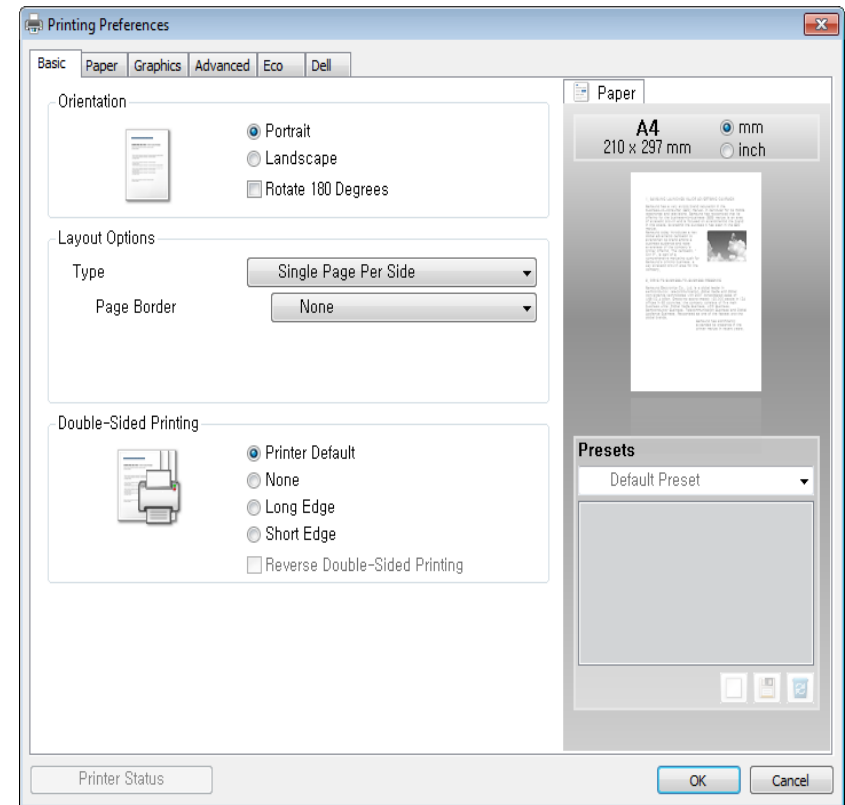

You can check the machine's current status using the **Printer Status** button (see "Using Dell Printer Status" on page 191).

Basic printing

Using a favorite setting

The **Favorites** option, which is visible on each preferences tab except for the **Dell** tab, allows you to save the current preferences for future use.

To save a **Favorites** item, follow these steps:

- 1 Change the settings as needed on each tab.
- 2 Enter a name for the item in the **Favorites** input box.

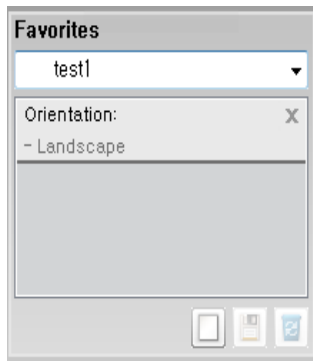

- 3 Click (**Add**). When you save **Favorites**, all current driver settings are saved.



Select more options and click  (**Update**), settings will be added to the Favorites you made. To use a saved setting, select it from the **Favorites** drop-down list. The machine is now set to print according to the settings you have selected.

To delete saved settings, select it from the **Favorites** drop-down list and click  (**Delete**).

You can also restore the printer driver's default settings by selecting **Default Favorite** from the **Favorites** drop-down list.

Using help

Click the option you want to know on the **Printing Preferences** window and press **F1** on your keyboard.

Eco printing

The **Eco** function reduces toner consumption and paper usage. The **Eco** function allows you to save print resources and lead you to eco-friendly printing.

If you press the  (**Eco**) button from the control panel, eco mode is enabled. The default setting of Eco mode is **Double-sided printing (Long Edge)**, **Multiple Pages per Side (2)**, **Skip blank pages**, and **Toner Save**.

Basic printing

Setting Eco mode on the control panel



- The settings set from the machine's driver override the settings on the control panel.
- Accessing menus may differ from model to model (see "Accessing the menu" on page 25).
- It may be necessary to press **OK** to navigate to lower-level menus.

1 Select  **(Menu) > System Setup > Machine Setup > Eco Settings** on the control panel.

2 Select the option you want and press **OK**.

- **Default Mode:** Select this to turn on or off the eco mode. (Duplex (long edge)/Toner save/2-up/Skip blank pages)
 - **Off:** Set the eco mode off.
 - **On:** Set the eco mode on.



If you set the eco mode on with a password from the Embedded Web Service (**Settings** tab > **Machine Settings** > **System** > **Eco** > **Settings**), the **On force** message appears. You have to enter the password to change the eco mode status.

- **Change Template:** Follow the settings from Embedded Web Service. Before you select this item, you must set the eco function in Embedded Web Service > **Settings** tab > **Machine Settings** > **System** > **Eco** > **Settings**.

3 Press **OK** to save the selection.

Setting eco mode on the driver

Open the Eco tab to set Eco mode. When you see the eco image (), that means the eco mode is currently enabled.

Eco options

- **Printer Default:** Follows the settings from the machine's control panel.
- **None:** Disables Eco mode.
- **Eco Printing:** Enables eco mode. Activate the various Eco items you want to use.
- **Password:** If the administrator has enabled Eco mode, you have to enter the password to change the status.

Basic printing

Result simulator

Result Simulator shows the results of reduced emission of carbon dioxide, used electricity, and the amount of saved paper in accordance with the settings you selected.



- The results are calculated on the basis that the total number of printed paper is one hundred without a blank page when the Eco mode is disabled.
- Refers to the calculation coefficient about CO₂, energy, and paper from **IEA**, the index of Ministry of Internal Affairs and Communication of Japan and www.remanufacturing.org.uk. Each model has a different index.
- The power consumption in printing mode refers to the average printing power consumption of this machine.
- The actual saved or reduced amount may differ depending on the operating system used, computing performance, application software, connection method, media, media size, job complexity, etc.

Basic copying



For special printing features, refer to the Advanced Guide (see "Copy menu" on page 136).

Basic copy

- 1 Select  (copy) on the control panel.
- 2 Place a single document face down on the document glass, or load the documents face up into the document feeder (see "Loading originals" on page 42).
- 3 If you want to customize the copy settings including **Reduce/Enlarge**, **Darkness**, **Contrast**, **Original**, and more by using the control panel buttons (see "Changing the settings for each copy" on page 51).
- 4 Enter the number of copies using the arrow or number keypad, if necessary.
- 5 Press  (**Start**).



If you need to cancel the copying job during the operation, press  (**Stop/Clear**) and the copying will stop.

Changing the settings for each copy

Your machine provides default settings for copying so that you can quickly and easily make a copy. However, if you want to change the options for each copy, use the copy function buttons on the control panel.







- If you press  (**Stop/Clear**) while setting the copy options, all of the options you have set for the current copy job will be canceled and returned to their default status. Or, they will automatically return to their default status after the machine completes the copy in progress.
- Accessing menus may differ from model to model (see "Accessing the menu" on page 25).
- It may be necessary to press **OK** to navigate to lower-level menus.

Darkness

If you have an original containing faint marking and dark images, you can adjust the brightness to make a copy that is easier to read.

Basic copying

1 Select  (copy) >  (Menu) > **Copy Feature** >  (**Darkness**) on the control panel.

Or select  (**Darkness**) button on the control panel.



2 Select the option you want and press **OK**.

For example, the **Light+5** being the lightest, and the **Dark+5** being the darkest.

3 Press  (**Stop/Clear**) to return to ready mode.

Contrast

The Contrast menu lets you increase or decrease the difference between the bright and dark areas of an image.

1 Select  (copy) >  (Menu) > **Copy Feature** > **Contrast** on the control panel.



2 Select the option you want and press **OK**.

Select **Dark** to heighten the contrast and select **Light** to reduce it.

3 Press  (**Stop/Clear**) to return to ready mode.

Original

The original setting is used to improve the copy quality by selecting the document for the current copy job.

1 Select  (copy) >  (Menu) > **Copy Feature** > **Original** type on the control panel.

2 Select the option you want and press **OK**.

- **Text:** Use for originals containing mostly text.
- **Text/Photo:** Use for originals with mixed text and photographs.



If texts in the printout is blurry, select **Text** to get the clear texts.

- **Photo:** Use when the originals are photographs.

3 Press  (**Stop/Clear**) to return to ready mode.

Reduced or enlarged copy

You can reduce or enlarge the size of a copied image from 25% to 400% when you copy original documents from the scanner glass.

Basic copying





- This feature may not be available depending on model or optional goods (see "Variety feature" on page 7).
- If the machine set to Eco mode, reduce and enlarge features are not available.





When you make a reduced copy, black lines may appear at the bottom of your copy.

To select from the predefined copy sizes

- 1 Select  (copy) >  (Menu) > **Copy Feature** > **Reduce/Enlarge** on the control panel.
- 2 Select the option you want and press **OK**.
- 3 Press  (**Stop/Clear**) to return to ready mode.

To scale the copy by directly entering the scale rate



- 1 Select  (copy) >  (Menu) > **Copy Feature** > **Reduce/Enlarge** > **Custom** on the control panel.
- 2 Enter the copy size you want using the numeric keypad.
- 3 Press **OK** to save the selection.
- 4 Press  (**Stop/Clear**) to return to ready mode.

ID card copying

Your machine can print 2-sided originals on one sheet.

The machine prints one side of the original on the upper half of the paper and the other side on the lower half without reducing the size of the original. This feature is helpful for copying a small-sized item such as business card.



- The original must be placed on the scanner glass to use this feature.
- If the machine set to Eco mode, this feature is not available.
- For better image quality, Select  (copy) >  (Menu) > **Copy Feature** > **Original Type** > **Photo** on the control panel.

Basic copying

1 Press  (**ID Copy**) on the control panel.

2 Place the front side of an original facing down on the scanner glass where arrows indicate as shown. Then, close the scanner lid.

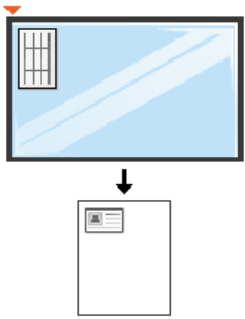

3 **Place Front Side and Press [Start]** appears on the display.

4 Press **Start**.

Your machine begins scanning the front side and shows **Place Back Side and Press [Start]**.

5 Turn the original over and place it on the scanner glass where arrows indicate as shown. Then, close the scanner lid.

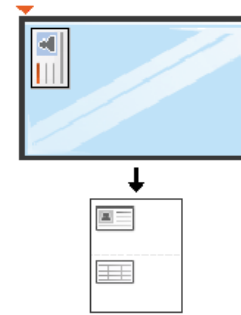

6 Press **Start**.



- If you do not press the  (**Start**) button, only the front side will be copied.
- If the original is larger than the printable area, some portions may not be printed.

Basic scanning



For special scanning features, refer to the Advanced Guide (see "Scan features" on page 167).

Basic Scanning

This is the normal and usual procedure for scanning originals.

This is a basic scanning method for USB-connected machine.



- It may be necessary to press **OK** to navigate to lower-level menus for some models.
- if you want to scan using the network, refer to the Advanced Guide (see "Scanning from network connected machine" on page 171).

1 Place a single document face down on the document glass, or load the documents face up into the document feeder (see "Loading originals" on page 42).

2 Select  (scan) > **Scan to PC** > **Local PC** on the control panel.



If you see **Not Available** message, check the port connection, or select

Enable Scan from Device Panel in **Dell Printer Manager** >  **Switch to advanced mode** > **Scan to PC Settings**.

3 Select the application program you want and press **OK**.
Default setting is **My Documents**.



You can add or delete the folder where the scanned file is saved in **Dell**

Printer Manager >  **Switch to advanced mode.** > **Scan to PC Settings**.

4 Select the option you want and press **OK**.

5 Scanning begins.



Scanned image is saved in computer's **C:\Users\users name\My**

- **Documents**. The saved folder may differ, depending on your operating system or the application you are using.

Basic faxing



For special faxing features, refer to the Advanced Guide (See "Fax features" on page 174).



- You cannot use this machine as a fax via the internet phone. For more information ask your internet service provider.
- We recommend using traditional analog phone services (PSTN: Public Switched Telephone Network) when connecting telephone lines to use a fax machine. If you use other Internet services (DSL, ISDN, VoIP), you can improve the connection quality by using the Micro-filter. The Micro-filter eliminates unnecessary noise signals and improves connection quality or Internet quality. Since the DSL Micro-filter is not provided with the machine, contact your Internet service provider for use on DSL Micro-filter.

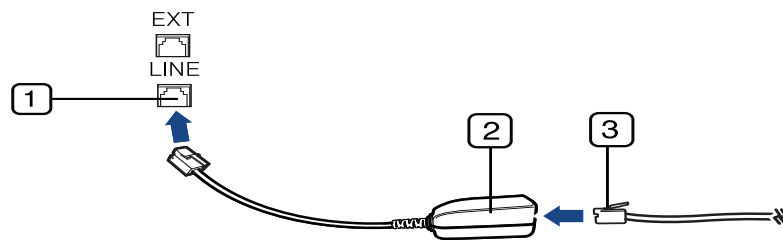

- 1 Line port
- 2 Micro filter
- 3 DSL modem / Telephone line (see "Rear view" on page 17).

Preparing to fax

Before you send or receive a fax, you need to connect the supplied line cord to your telephone wall jack (see "Rear view" on page 17). Refer to the Quick Installation Guide how to make a connection. The method of making a telephone connection is different from one country to another.

Sending a fax



- When you place the originals, you can use either the document feeder or the scanner glass. If the originals are placed on both the document feeder and the scanner glass, the machine will read the originals on the document feeder first, which has higher priority in scanning.

- 1 Place a single document face down on the document glass, or load the documents face up into the document feeder (see "Loading originals" on page 42).
- 2 Select  (fax) on the control panel.
- 3 Adjust the resolution and the darkness to suit your fax needs (see "Adjusting the document settings" on page 58).
- 4 Enter the destination fax number.

Basic faxing

- 5 Press  (**Start**) on the control panel. The machine starts to scan and send the fax to the destinations.



- If you want to send a fax directly from your computer, use Dell Network PC Fax (see "Sending a fax in the computer" on page 175).
- When you want to cancel a fax job, press  (**Stop/Clear**) before the machine starts transmission.
- If you used the scanner glass, the machine shows the message asking to place another page.

Sending a fax manually

Perform the following to send a fax using  (**On Hook Dial**) on the control panel. If your machine is a handset model, you can send a fax using the handset (see "Features" on page 6).

- 1 Place a single document face down on the document glass, or load the documents face up into the document feeder (see "Loading originals" on page 42).
- 2 Select  (fax) on the control panel.
- 3 Adjust the resolution and the darkness to suit your fax needs (see "Adjusting the document settings" on page 58).
- 4 Press **On Hook Dial** on the control panel or lift the handset.

- 5 Enter a fax number using the number keypad on the control panel.



- 6 Press  (**Start**) on the control panel when you hear a high-pitched fax signal from the remote fax machine.

Sending a fax to multiple destinations

You can use the multiple send feature, which allows you to send a fax to multiple locations. Originals are automatically stored in memory and sent to a remote station. After transmission, the originals are automatically erased from memory (see "Features" on page 6).



You cannot send faxes with this feature if you chosen super fine as an option or if the fax is in color.

- 1 Place a single document face down on the document glass, or load the documents face up into the document feeder (see "Loading originals" on page 42).
- 2 Select  (fax) on the control panel.
- 3 Adjust the resolution and the darkness to suit your fax needs (see "Adjusting the document settings" on page 58).
- 4 Select  (**Menu**) > **Fax Feature** > **Multi Send** on the control panel.

Basic faxing

- 5 Enter the number of the first receiving fax machine and press **OK**.
You can press speed dial numbers or select a group dial number using the  (**Address book**) button (see Advanced Guide).
- 6 Enter the second fax number and press **OK**.
The display asks you to enter another fax number to send the document.
- 7 To enter more fax numbers, press **OK** when **Yes** appears and repeat steps 5 and 6. You can add up to 10 destinations.



Once you have entered a group dial number, you cannot enter another group dial number.

- 8 When you have finished entering fax numbers, select **No** at the **Another No.?** prompt and press **OK**.

The machine begins sending the fax to the numbers you entered in the order in which you entered them.

Receiving a fax

Your machine is preset Fax mode at the factory. When you receive a fax, the machine answers the call on a specified number of rings and automatically receives the fax.

Adjusting the document settings



Before starting a fax, change the following settings according to your original's status to get the best quality.



It may be necessary to press **OK** to navigate to lower-level menus.

Resolution

The default document settings produce good results when using typical text-based originals. However, if you send originals that are of poor quality, or contain photographs, you can adjust the resolution to produce a higher quality fax.

- 1 Select  (fax) >  (**Menu**) > **Fax Feature** > **Resolution** on the control panel.
- 2 Select the option you want and press **OK**.
 - **Standard:** Originals with normal sized characters.
 - **Fine:** Originals containing small characters or thin lines or originals printed using a dot-matrix printer.
 - **Super Fine:** Originals containing extremely fine detail. **Super Fine** mode is enabled only if the machine with which you are communicating also supports the Super Fine resolution.

Basic faxing



- For memory transmission, **Super Fine** mode is not available. The resolution setting is automatically changed to **Fine**.
- When your machine is set to **Super Fine** resolution and the fax machine with which you are communicating does not support **Super Fine** resolution, the machine transmits using the highest resolution mode supported by the other fax machine.

- **Photo Fax:** Originals containing shades of gray or photographs.
- **Color Fax:** Original with colors.



- Memory transmission is not available in this mode.
- You can only send a color fax if the machine you are communicating with supports color fax reception and you send the fax manually.





3 Press  (**Stop/Clear**) to return to ready mode.

Darkness

You can select the degree of darkness of the original document.



The darkness setting is applied to the current fax job. To change the default setting (see "Fax menu" on page 140).

- 1** Select  (fax) >  (**Menu**) > **Fax Feature** >  (**Darkness**) on the control panel.
- 2** Select a darkness level you want.
- 3** Press  (**Stop/Clear**) to return to ready mode.



3. Maintenance

This chapter provides information about purchasing supplies, accessories and maintenance parts available for your machine.

- **Ordering supplies and accessories** 61
- **Available supplies** 62
- **Redistributing toner** 65
- **Replacing the toner cartridge** 66
- **Monitoring the supplies life** 67
- **Setting the toner low alert** 68
- **Cleaning the machine** 69

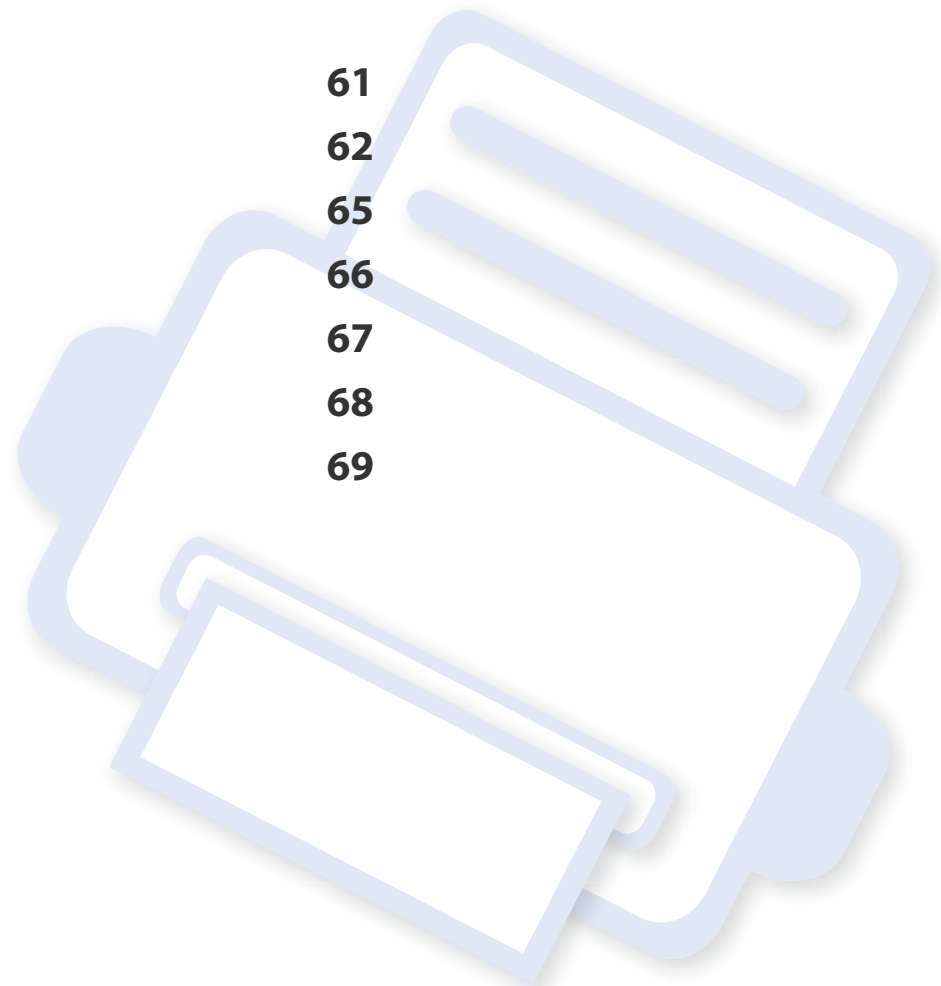

Ordering supplies and accessories



Available accessories may differ from country to country. Contact your sales representatives to obtain the list of available supplies, and maintenance parts.

To order Dell-authorized supplies and accessories visit www.dell.com/supplies, or contact your local Dell dealer or the retailer where you purchased your machine. You can also visit www.dell.com or support.dell.com, select your country/region, and obtain information on calling for service.

Available supplies

When supplies reach the end of their life spans, you can order the following s of supplies for your machine:

Type	Average yield ^a	Part name
Standard yield toner cartridge	Approx. 1,500 pages	<ul style="list-style-type: none">• G9W85 (All contries except China)
High yield toner cartridge	Approx. 2,500 pages	<ul style="list-style-type: none">• DRYXV (All contries except China)• 10G0D (For China only)

a. Declared yield value in accordance with ISO/IEC 19752.



Depending on the options, percentage of image area and job mode used, the toner cartridge's lifespan may differ.



When purchasing new toner cartridges or other supplies, these must be purchased in the same country as the machine you are using. Otherwise, new toner cartridges or other supplies will be incompatible with your machine due to different configurations of toner cartridges and other supplies according to the specific country conditions.



Dell does not recommend using non-genuine Dell toner cartridge such as refilled or remanufactured toner. Dell cannot guarantee non-genuine Dell toner cartridge's quality. Service or repair required as a result of using non-genuine Dell toner cartridges will not be covered under the machine's warranty.

Storing the toner cartridge

Toner cartridges contain components that are sensitive to light, temperature and humidity. Dell suggests users follow these recommendations to ensure optimal performance, highest quality, and longest life from your new Dell toner cartridge.

Store this cartridge in the same environment in which the printer will be used. This should be in controlled temperature and humidity conditions. The toner cartridge should remain in its original and unopened package until installation – if original packaging is not available, cover the top opening of the cartridge with paper and store in a dark cabinet.

Opening the cartridge package prior to use dramatically shortens its useful shelf and operating life. Do not store on the floor. If the toner cartridge is removed from the printer, follow the instructions below to store the toner cartridge properly.

- Store the cartridge inside the protective bag from the original package.
- Store lying flat (not standing on end) with the same side facing up as if it were installed in the machine.
- Do not store consumables in any of the following conditions:
 - Temperature greater than 40°C (104°F).
 - Humidity range less than 20% and greater than 80%.
 - An environment with extreme changes in humidity or temperature.
 - Direct sunlight or room light.
 - Dusty places.
 - A car for a long period of time.
 - An environment where corrosive gases are present.

- An environment with salty air.

Handling instructions

- Do not touch the surface of the photoconductive drum in the cartridge.
- Do not expose the cartridge to unnecessary vibrations or shock.
- Never manually rotate the drum, especially in the reverse direction; this can cause internal damage and toner spillage.

Toner cartridge usage

Dell Inc. does not recommend or approve the use of non-Dell brand toner cartridges in your printer including generic, store brand, refilled, or remanufactured toner cartridges.



Dell's printer warranty does not cover damage to the machine caused by the use of a refilled, remanufactured, or non-Dell brand toner cartridges.

Storing the toner cartridge

Estimated cartridge life

Estimated cartridge life the life of the toner cartridge (or imaging unit) yield depends on the amount of toner that print jobs require. The actual print yield may vary depending on the print density of the pages you print on, operating environment, percentage of image area, printing interval, media type and/or media size. For example, if you print a lot of graphics, the consumption of the toner is higher and you may need to change the cartridge more often.

Redistributing toner

When the toner cartridge is near the end of its life:

- White streaks or light printing occurs and/or density variation side to side.
- The **Status** LED blinks red.

If this happens, you can temporarily improve print quality by redistributing the remaining toner in the cartridge. In some cases, white streaks or light printing will still occur even after you have redistributed the toner.



If toner gets on your clothing, wipe it off with a dry cloth and wash clothing in cold water: hot water sets toner into fabric.



Do not touch the green underside of the toner cartridge. Use the handle on the cartridge to avoid touching this area.

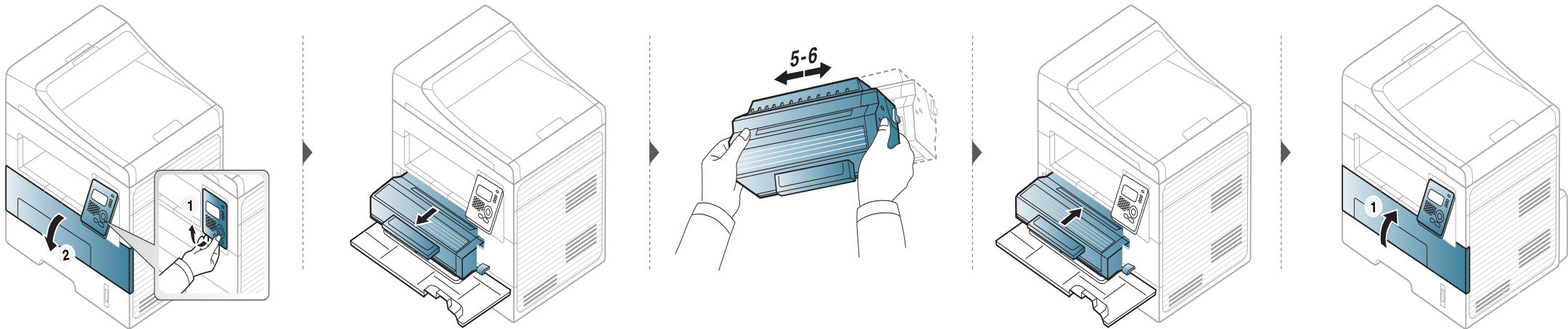

Replacing the toner cartridge



- Do not use sharp objects such as a knife or scissors to open the toner cartridge package. They might scratch the drum of the cartridge.
- If toner gets on your clothing, wipe it off with a dry cloth and wash clothing in cold water. Hot water sets toner into fabric.
- Shake the toner cartridge thoroughly, it will increase the initial print quality.
- Do not touch the green underside of the toner cartridge. Use the handle on the cartridge to avoid touching this area.

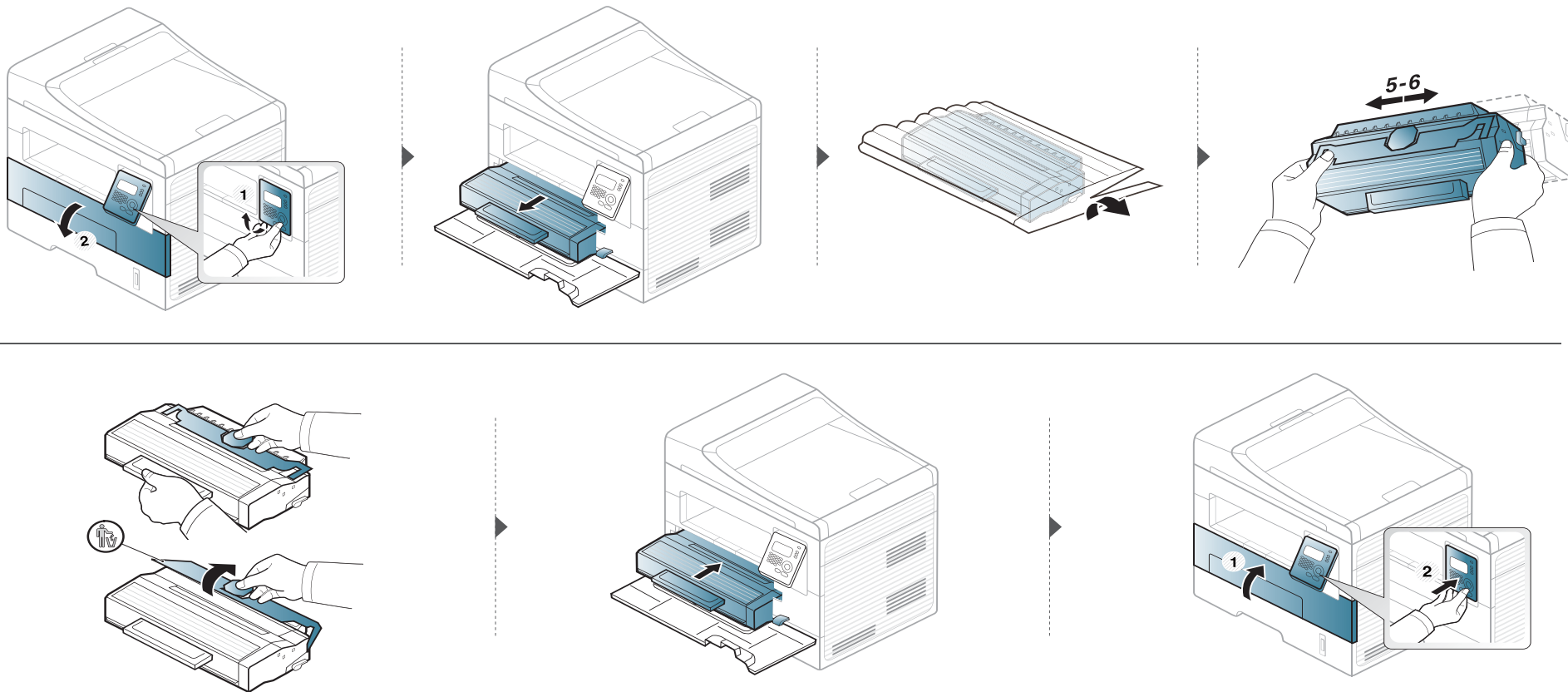

When a toner cartridge has reached the end of life, the machine will stop printing.



Monitoring the supplies life

If you experience frequent paper jams or printing problems, check the number of pages the machine has printed or scanned. Replace the corresponding parts, if necessary.

 It may be necessary to press **OK** to navigate to lower-level menus for some models.

- 1 Select  (**Menu**) > **System Setup** > **Maintenance** > **Supplies Life** on the control panel.
- 2 Select the option you want and press **OK**.
 - **Supplies Info**: Prints the supply information page.
 - **Total**: Displays the total number of pages printed.
 - **ADF Scan**: Displays the number of pages printed by using the document feeder.
 - **Platen Scan**: Displays the number of pages scanned by using scanner glass.
- 3 Press  (**Stop/Clear**) to return to ready mode.

Setting the toner low alert

If the amount of toner in the cartridge is low, a message or LED informing the user to change the toner cartridge appears. You can set the option for whether or not this message or LED appears.

- 1 Select  (**Menu**) > **System Setup** > **Maintenance** > **Toner Low Alert** on the control panel.
- 2 Select the option you want.
- 3 Press **OK** to save the selection.

Cleaning the machine

If printing quality problems occur or if you use your machine in a dusty environment, you need to clean your machine regularly to keep it in the best printing condition and use your machine longer.



- Cleaning the cabinet of the machine with cleaning materials containing large amounts of alcohol, solvents, or other strong substances can discolor or distort the cabinet.
- If your machine or the surrounding area is contaminated with toner, we recommend you use a cloth or tissue dampened with water to clean it. If you use a vacuum cleaner, toner blows in the air and might be harmful to you.
- During the printing process, paper, toner, and dust particles can accumulate inside the machine. This buildup can cause print quality problems, such as toner specks or smearing. Cleaning the inside of the machine clears and reduces these problems.

Cleaning the outside

Clean the machine cabinet with a soft, lint-free cloth. Dampen the cloth slightly with water, but be careful not to let any water drip onto or into the machine.

Cleaning the inside

During the printing process, paper, toner, and dust particles can accumulate inside the machine. This buildup can cause print quality problems, such as toner specks or smearing. Cleaning the inside of the machine clears and reduces these problems.

Cleaning the machine



- Use a dry lint-free cloth to clean the machine.
- If your machine has a power switch, turn the power switch off before cleaning the machine.
- Before opening the front cover, close the output support first.

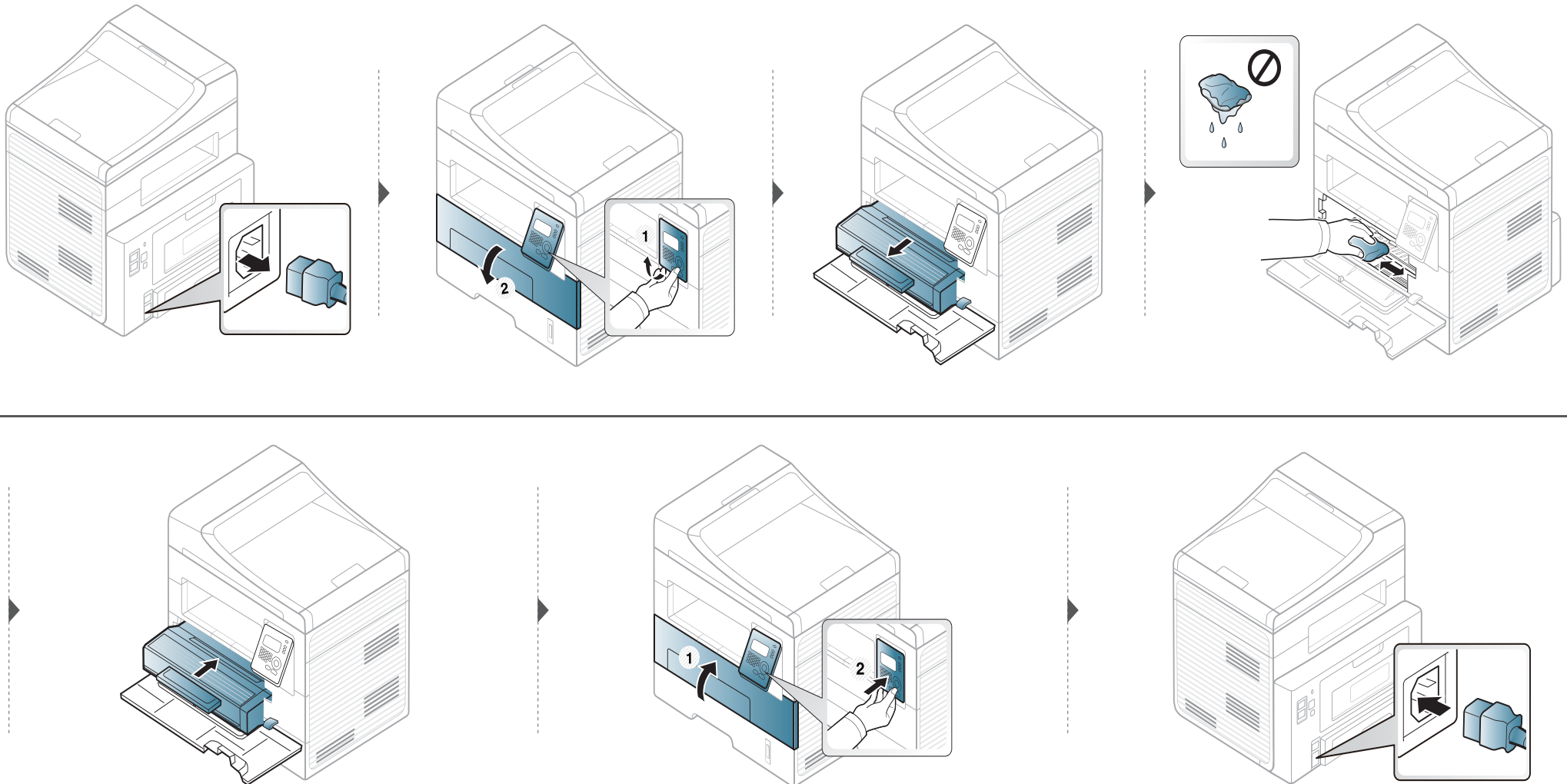

Cleaning the machine

Cleaning the pickup roller

- Before opening the front cover, close the output support first.
- If your machine has a power switch, turn the power switch before cleaning the machine.

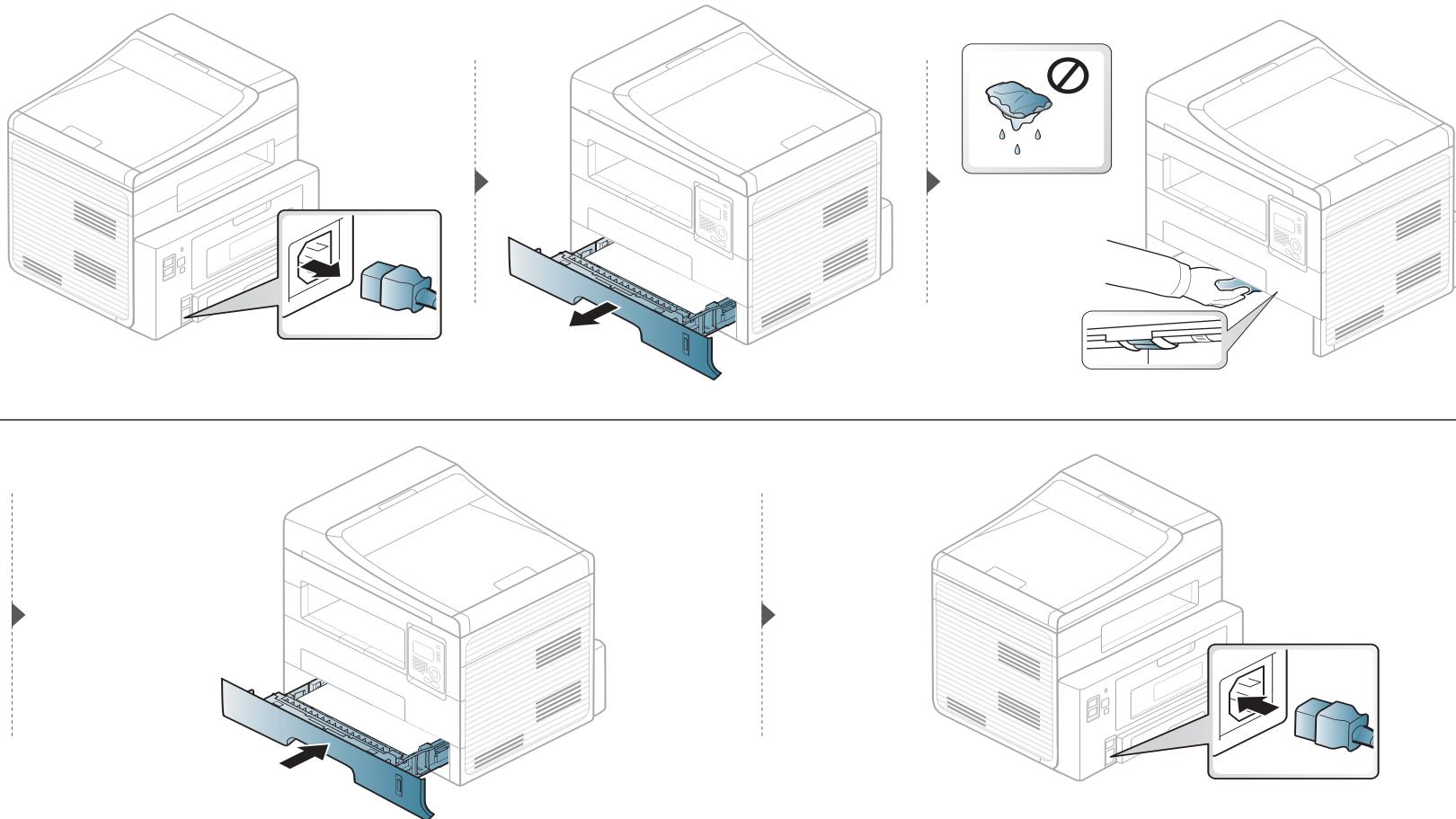

Cleaning the machine

Cleaning the scan unit

Keeping the scan unit clean helps ensure the best possible copies. We suggest that you clean the scan unit at the start of each day and during the day as needed.

- 1 Slightly dampen a soft, lint-free cloth or paper towel with water.
- 2 Lift and open the scanner lid.
- 3 Wipe the surface of the scanner glass until it is clean and dry.

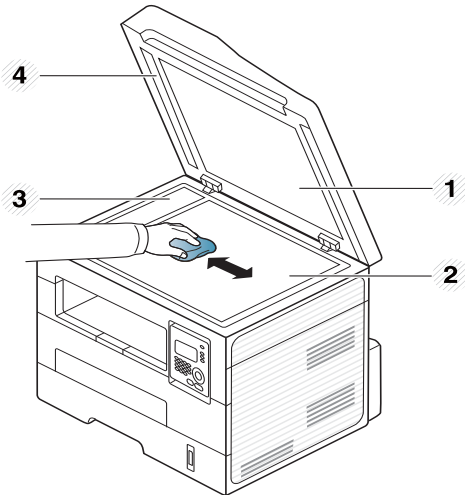

- 1 Scanner lid
- 2 Scanner glass
- 3 Document feeder glass
- 4 White bar

- 4 Wipe the underside of the scanner lid and white sheet until it is clean and dry.
- 5 Close the scanner lid.

Tips for moving & storing your machine

- When moving the machine, do not tilt or turn it upside down. Otherwise, the inside of the machine may be contaminated by toner, which can cause damage to the machine or reduce print quality.
- When moving the machine, make sure at least two people are holding the machine securely.



4. Troubleshooting

This chapter gives helpful information for what to do if you encounter an error.

- **Tips for avoiding paper jams** 75
- **Clearing original document jams** 76
- **Clearing paper jams** 80
- **Understanding the status LED** 85
- **Understanding display messages** 87



This chapter gives helpful information for what to do if you encounter an error. If your machine has a display screen, check the message on the display screen first to solve the error.

If you cannot find a solution to your problem in this chapter, refer to the **Troubleshooting** chapter in the Advanced User's Guide.

If you cannot find a solution in the User's Guide or the problem persists, call for service.

Tips for avoiding paper jams

By selecting the correct medias, most paper jams can be avoided. To avoid paper jams, refer to the following guidelines:

- Ensure that the adjustable guides are positioned correctly (see "Tray overview" on page 31).
- Do not overload the tray. Ensure that the paper level is below the paper capacity mark on the inside of the tray.
- Do not remove paper from the tray while your machine is printing.
- Flex, fan, and straighten paper before loading.
- Do not use creased, damp, or highly curled paper.
- Do not mix paper s in a tray.
- Use only recommended print media (see "Print media specifications" on page 94).

Clearing original document jams

When an original document jams in the document feeder, a warning message appears on the display.

 To avoid tearing the document, remove the jammed document slowly and carefully.

 To prevent document jams, use the scanner glass for thick, thin or mixed paper- originals.

Clearing original document jams

Original paper jam in front of scanner

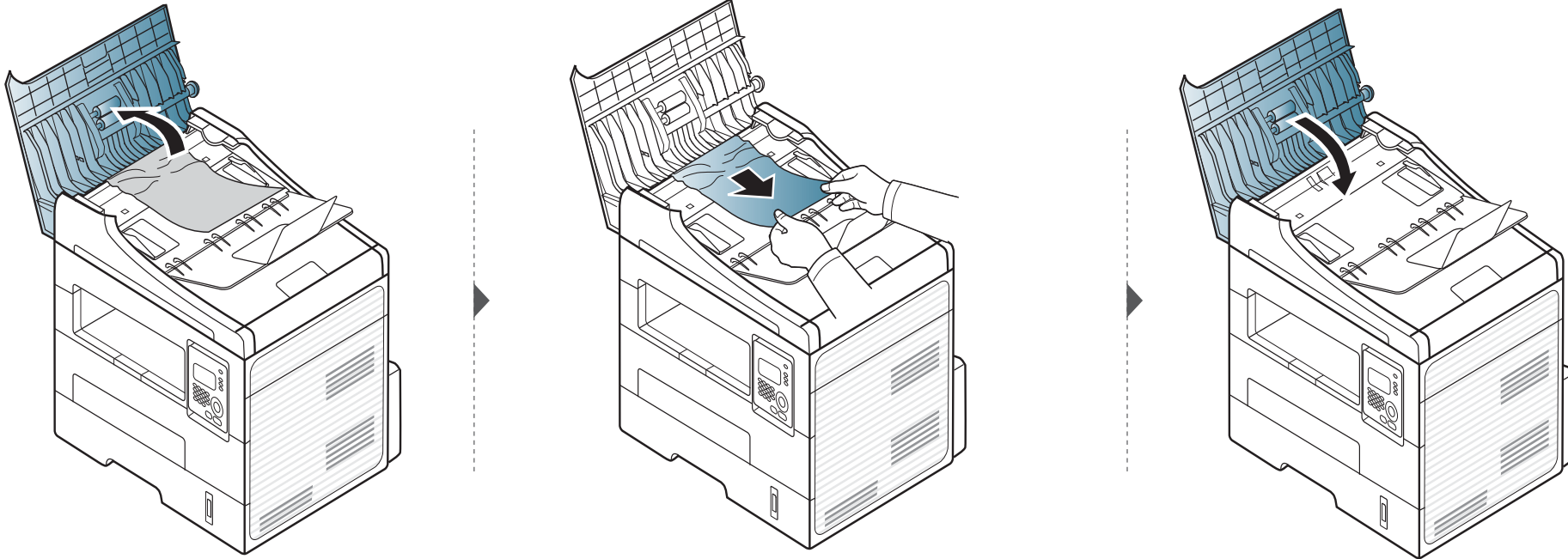

Clearing original document jams

Original paper jam inside of scanner

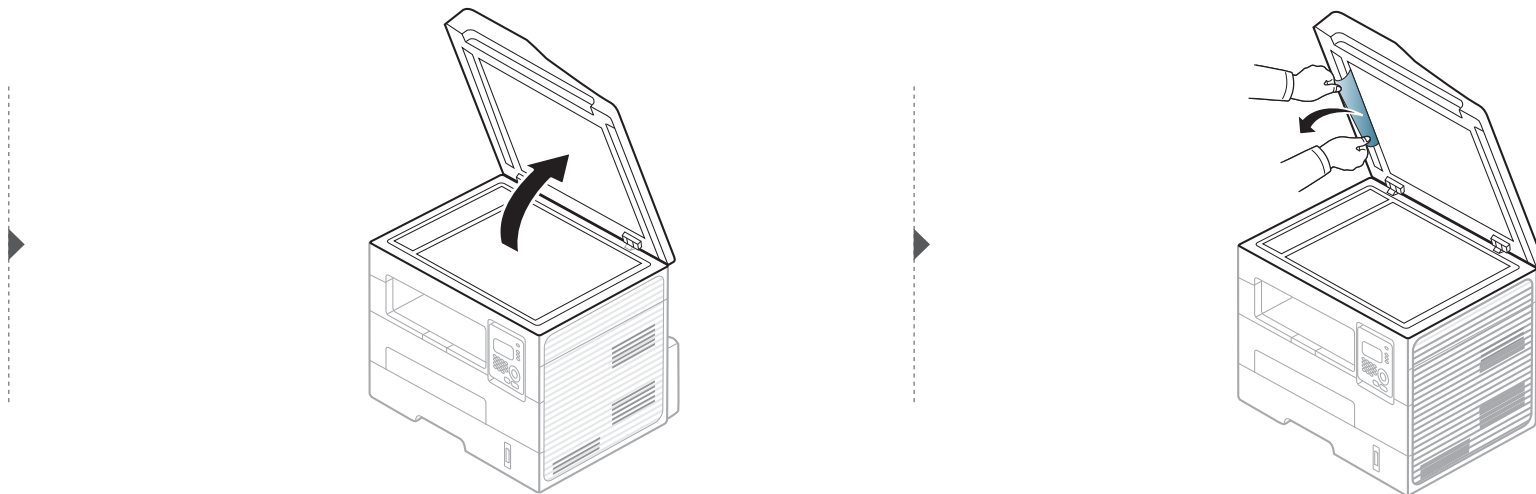
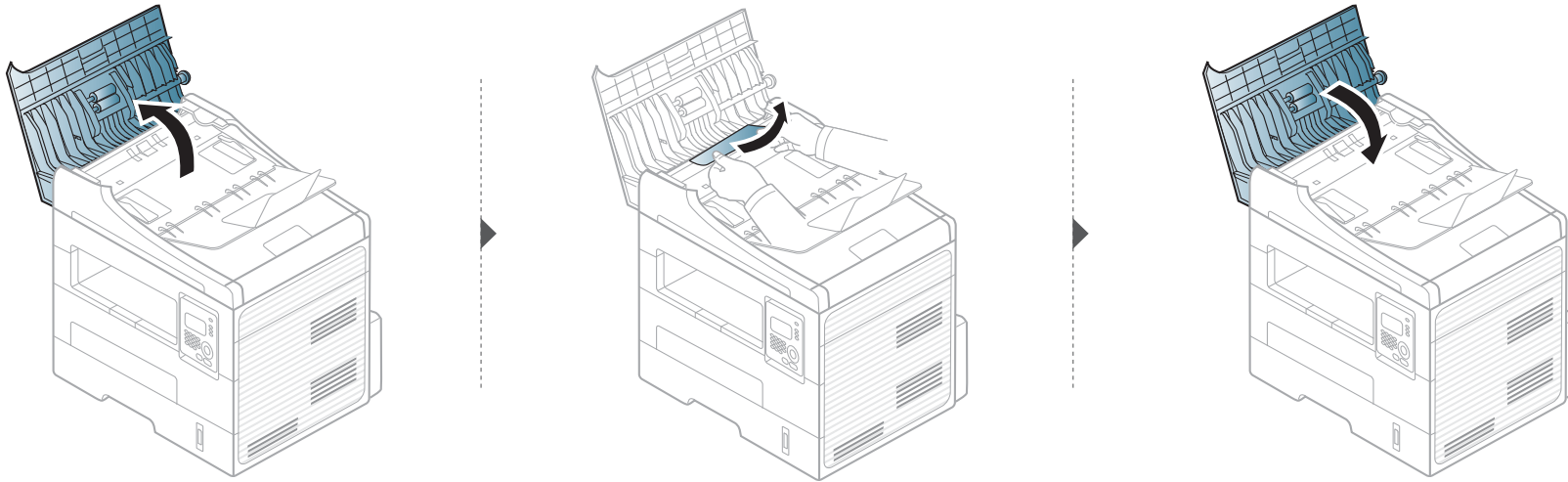

Clearing original document jams

Original paper jam in exit area of scanner

- 1 Remove any remaining pages from the document feeder.
- 2 Gently remove the jammed paper from the document feeder.

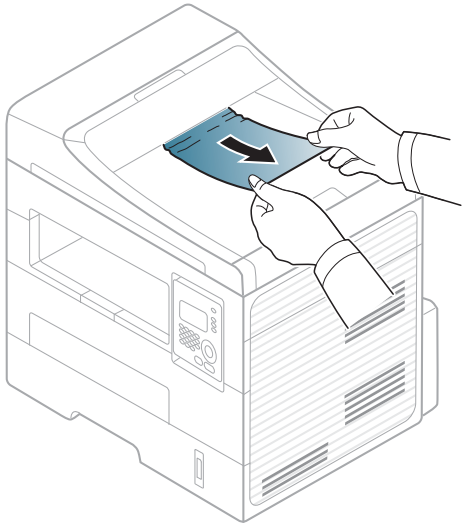

Clearing paper jams



To avoid tearing the paper, pull the jammed paper out slowly and gently.

In tray

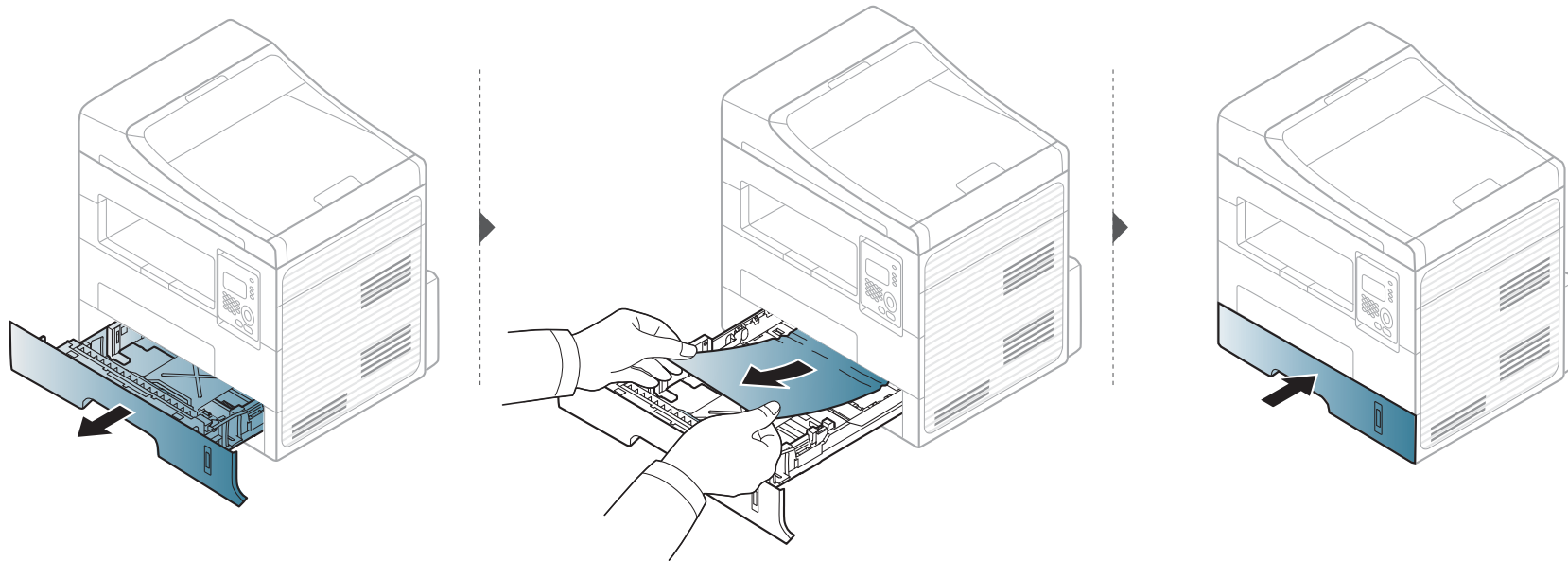

Clearing paper jams

In the manual tray

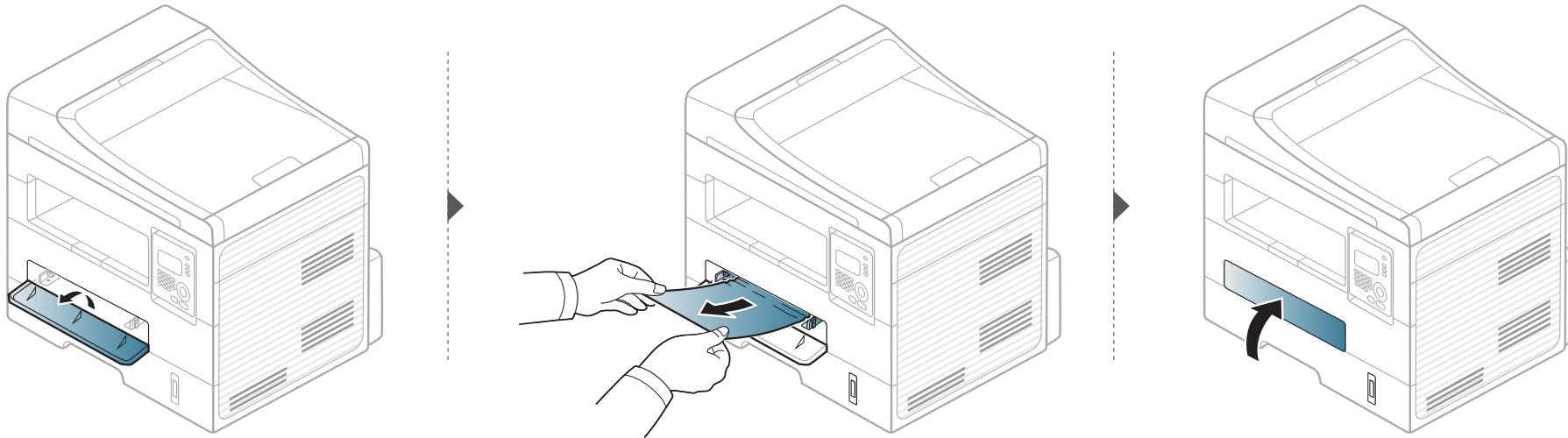

Clearing paper jams

Inside the machine



The fuser area is hot. Take care when removing paper from the machine.

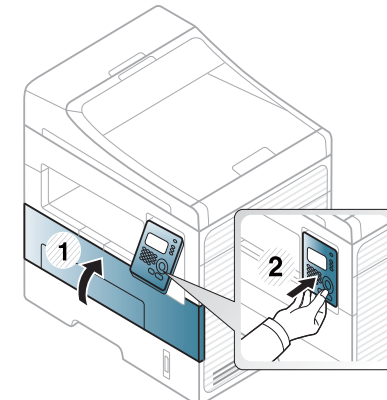
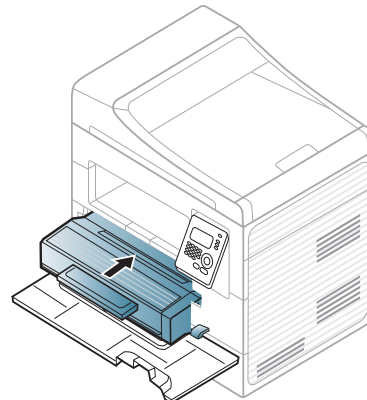
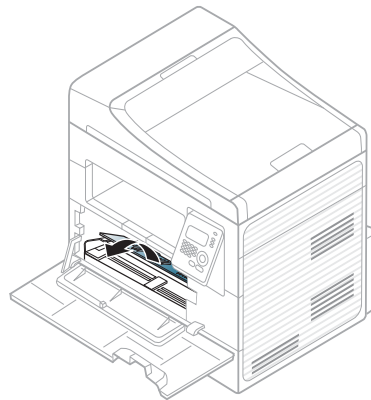
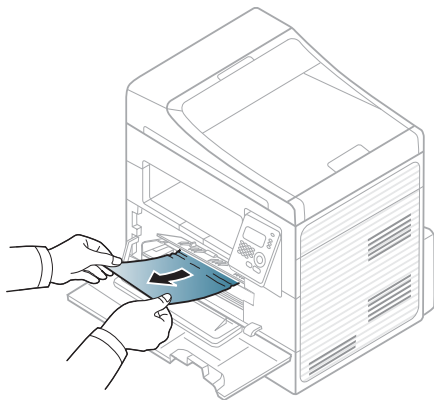
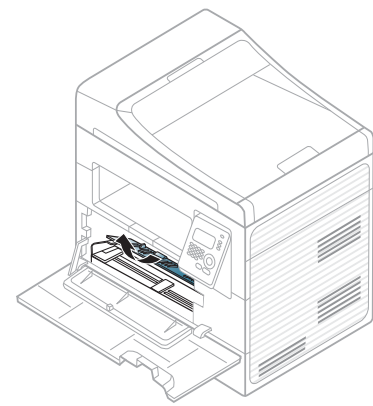
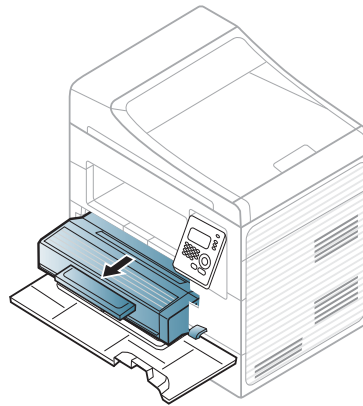
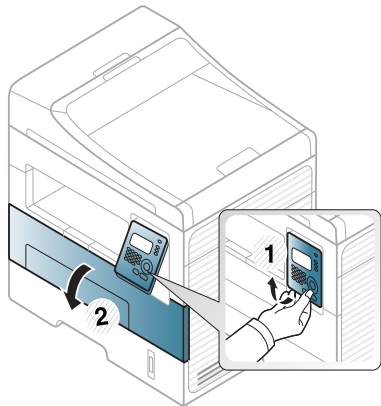

Clearing paper jams

In the exit area

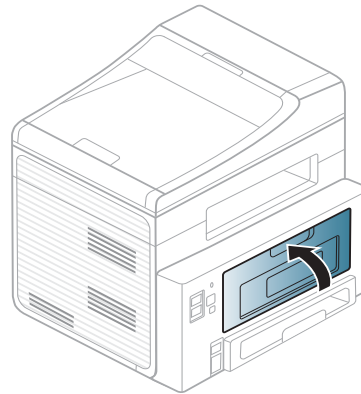
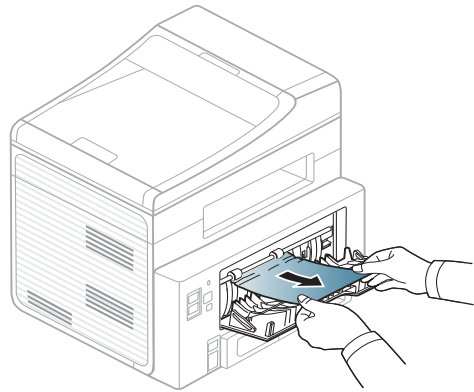
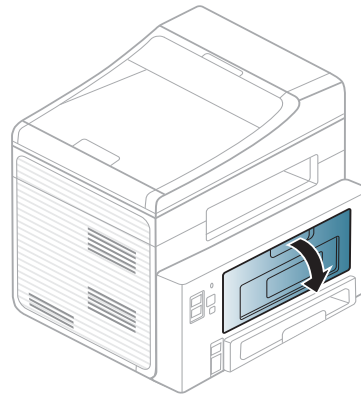
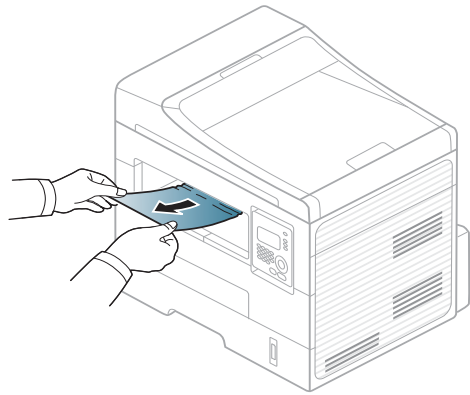

Clearing paper jams

In the duplex unit area

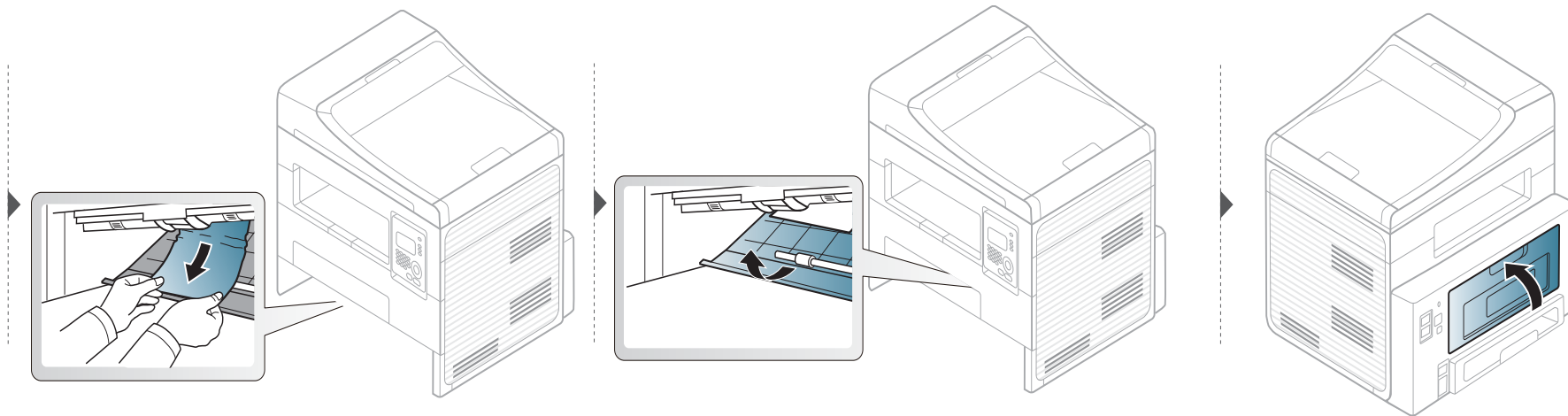
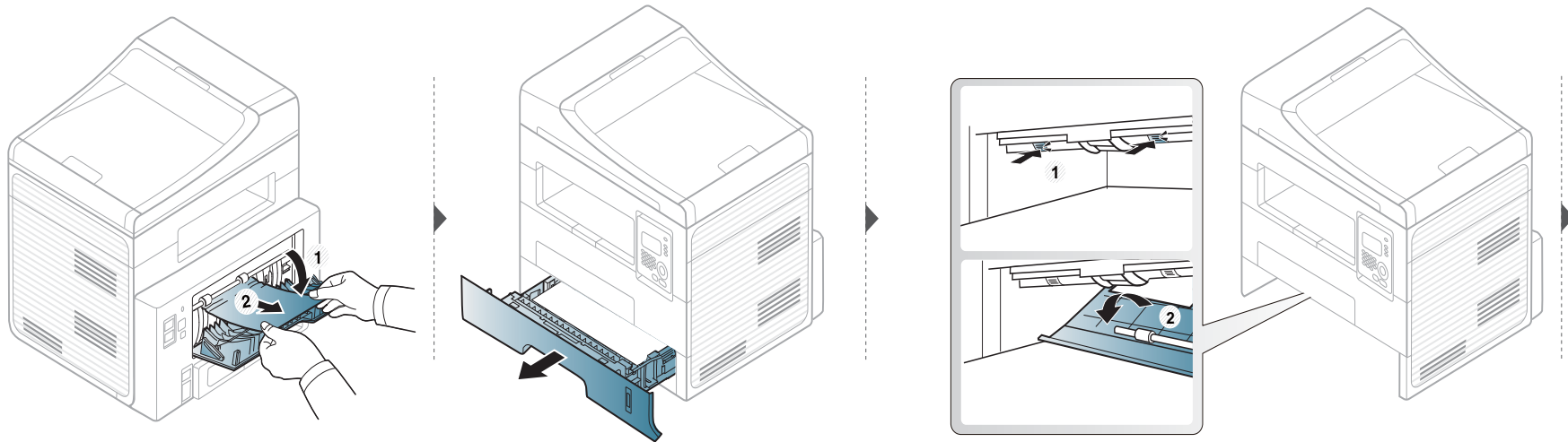

Understanding the status LED



The color of the LED indicates the machine's current status.



- Some LEDs may not be available depending on model or country.
- To resolve the error, look at the error message and its instructions from the troubleshooting part.
- You also can resolve the error with the guideline from the Printing Status Monitor program window.
- If the problem persists, call a service representative.

Status		Description	
Status LED	Off	The machine is off-line.	
	Green	Blinking	When the backlight blinks, the machine is receiving or printing data.
		On	<ul style="list-style-type: none">• The machine is on-line and can be used.
	Red	Blinking	<ul style="list-style-type: none">• A minor error has occurred and the machine is waiting for the error to be cleared. Check the display message. When the problem is cleared, the machine resumes. For some models that does not support the display screen on the control panel, this feature is not applicable.• Small amount of toner is left in the cartridge. The estimated cartridge life of toner is close. Prepare a new cartridge for replacement. You may temporarily increase the printing quality by redistributing the toner (see "Redistributing toner" on page 65).
On		<ul style="list-style-type: none">• A toner cartridge has almost reached its estimated cartridge life^a. It is recommended to replace the toner cartridge (see "Replacing the toner cartridge" on page 66).• The cover is opened. Close the cover.• There is no paper in the tray. Load paper in the tray.• The machine has stopped due to a major error. Check the display message (see "Understanding display messages" on page 87).	

Understanding the status LED

Status		Description
 Power LED	Blue	On The machine is in power save mode.
		Off The machine is in ready mode or machine's power is off.
 Eco button	Green	On Eco mode is on. Duplex, 2-up, toner save on, skip blank page feature will automatically be applied when printing (see "Eco printing" on page 48).
		Off Eco mode is off.

- a. Estimated cartridge life means the expected or estimated toner cartridge life, which indicates the average capacity of print-outs and is designed pursuant to ISO/IEC 19752. The number of pages may be affected by operating environment, percentage of image area, printing interval, graphics, media and media size. Some amount of toner may remain in the cartridge even when red LED is on and the printer stops printing.

Understanding display messages

Messages appear on the control panel display to indicate the machine's status or errors. Refer to the tables below to understand the messages' and their meaning, and correct the problem, if necessary.



- If a message is not in the table, reboot the power and try the printing job again. If the problem persists, call a service representative.
- When you call for service, provide the service representative with the contents of display message.
- Some messages may not appear on the display depending on the options or models.
- [error number] indicates the error number.
- [tray type] indicates the tray number.

Paper Jam-related messages

Message	Meaning	Suggested solutions
Document jam Remove jam	The loaded original document has jammed in the document feeder.	Clear the jam (see "Clearing original document jams" on page 76).
Paper Jam in tray	Paper has jammed in the paper feed area.	Clear the jam (see "In tray" on page 80).



Message	Meaning	Suggested solutions
Paper Jam in Manual Feeder	Paper has jammed in the manual feeder.	Clear the jam (see "In the manual tray" on page 81).
Paper Jam inside machine	Paper has jammed in the inside machine.	Clear the jam (see "Inside the machine" on page 82).
Paper Jam in exit area	Paper has jammed in the paper exit area.	Clear the jam (see "In the exit area" on page 83).
<ul style="list-style-type: none">• Paper Jam bottom of duplex• Paper Jam top of duplex	Paper has jammed in the duplex area.	Clear the jam (see "In the duplex unit area" on page 84).

Understanding display messages

Toner-related messages

Message	Meaning	Suggested solutions
Install Toner Cartridge	A toner cartridge is not installed.	Install a toner cartridge.
Not Compatible Toner cartridge	The toner cartridge you have installed is not for your machine.	Install a Dell-genuine toner cartridge, designed for your machine.
Prepare new cartridge	Small amount of toner is left in the indicated cartridge. The estimated cartridge life of toner is close.	Prepare a new cartridge for a replacement. You may temporarily increase the printing quality by redistributing the toner (see "Redistributing toner" on page 65).

Understanding display messages

Message	Meaning	Suggested solutions
<ul style="list-style-type: none">• Replace new cartridge• Toner Exhausted	<p>A toner cartridge has reached its estimated cartridge life. The machine stops printing.</p> <div data-bbox="492 395 1294 884"><p>Estimated cartridge life means the expected or estimated toner cartridge life, which indicates the average capacity of print-outs and is designed pursuant to ISO/IEC 19752 (see "Available supplies" on page 62). The number of pages may be affected by operating environment, percentage of image area, printing interval, media, percentage of image area, and media size. Some amount of toner may remain in the cartridge even when replace new cartridge appears and the machine stops printing.</p></div>	<ul style="list-style-type: none">• You can choose Stop or Continue as shown on the control panel. If you select Stop, the printer stops printing and you cannot print any more without changing the cartridge. If you select Continue, the printer keeps printing but the printing quality cannot be guaranteed.• Replace the toner cartridge for the best print quality when this message appears. Using a cartridge beyond this stage can result in printing quality issues (see "Replacing the toner cartridge" on page 66). <div data-bbox="1321 676 2197 995"><p>Dell does not recommend using a non-genuine Dell toner cartridge such as refilled or remanufactured. Dell cannot guarantee a non-genuine Dell toner cartridge's quality. Service or repair required as a result of using non-genuine Dell toner cartridges will not be covered under the machine warranty.</p></div> <ul style="list-style-type: none">• If the machine stops printing, replace the toner cartridge (see "Replacing the toner cartridge" on page 66).

Understanding display messages

Tray-related messages

Message	Meaning	Suggested solutions
Output bin full Remove paper	The output tray is full.	Remove papers from the output tray, the printer resumes printing.
Paper Empty in [tray type]	There is no paper in tray or manual feeder.	Load paper in tray (see "Loading paper in the tray" on page 33, "Loading paper in the tray" on page 33).
<ul style="list-style-type: none">• Tray Paper mismatch• Manual Paper mismatch	The paper size specified in the printer properties does not match the paper you are loading.	Load the required size paper.

Network-related messages

Message	Meaning	Suggested solutions
Network Problem: IP Conflict	The network IP address you have set is being used by someone else.	Check the IP address and reset it if necessary (see Advanced Guide).

Misc. messages

Message	Meaning	Suggested solutions
Door of scanner is open	The document feeder cover is not securely latched.	Close the cover until it locks into place.
Error [error number] Turn off then on	The machine unit cannot be controlled.	Reboot the power and try the printing job again. If the problem persists, please call for service.
Memory Full Remove Job	The memory is full.	Print or remove the received fax job in Secure Receive (see Advanced Guide).
Scanner Locked	The scanner is locked.	Reboot the power. If the problem persists, please call for service.



5. Appendix

This chapter provides product specifications and information concerning applicable regulations.

- **Specifications** 92
- **Dell technical support policy** 102
- **Contacting Dell** 103
- **Warranty and return policy** 104
- **Copyright** 105

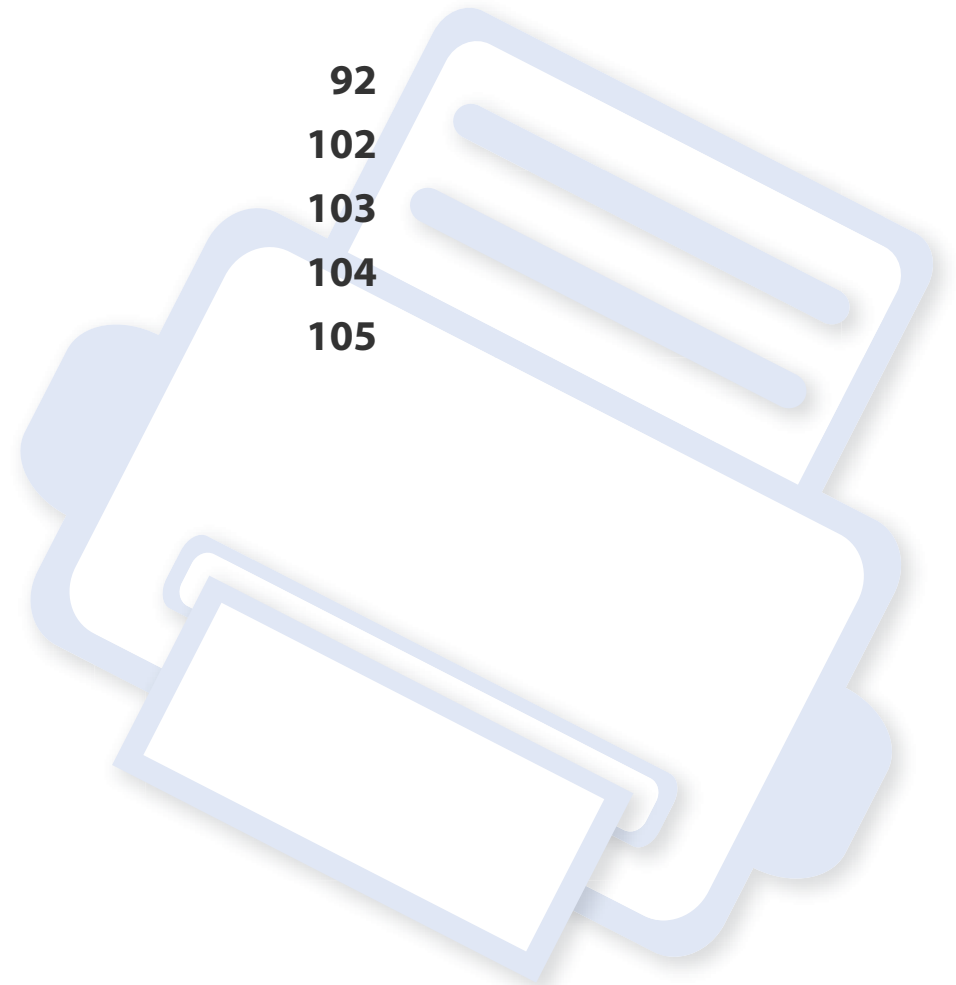

Specifications

General specifications



The specification values listed below are subject to change without notice. See www.dell.com or support.dell.com for possible changes in information.

Items		Description
Dimension	Width x Length x Height	406 x 338 x 384mm (15.98 x 13.30 x 15.12 inches)
Weight	Machine with consumables	10.4 Kg
Noise Level^a	Ready mode	26 dB (A)
	Print mode	Less than 50 dB (A)
	Copy mode	Less than 53 dB (A)
	Scan mode (scanner glass)	52 dB (A)
	Scan mode (document feeder)	53 dB (A)
Temperature	Operation	10 to 32°C (50 to 89.6°F)
	Storage (packed)	-20 to 40°C (-4 to 104°F)
Humidity	Operation	20 to 80% RH
	Storage (packed)	10 to 90% RH
Power rating^b	110 volt models	AC 110 - 127 V
	220 volt models	AC 220 - 240 V

Specifications

	Items	Description
Power consumption	Average operating mode	Less than 400W
	Ready mode	Less than 50 W
	Power save mode	Less than 3.0 W
	Power off mode	Less than 0.2 W
	Network Standby Mode (All Port Activation)	Less than 3.0 W

- a. Sound Pressure Level, ISO 7779. Configuration tested: basic machine installation, A4 paper, simplex printing.
- b. See the rating label on the machine for the correct voltage (V), frequency (hertz) and of current (A) for your machine.

Specifications

Print media specifications

Type	Size	Dimensions	Print media weight/Capacity ^a	
			Tray	Manual feeder ^b
Plain paper	Letter	216 x 279 mm (8.5 x 11 inches)	70 to 90 g/m ² (16 to 43 lbs bond) • 250 sheets of 80 g/m ² (21 lbs bond)	70 to 90 g/m ² (19 to 24 lbs bond) • 1 sheet of 80 g/m ² (21 lbs bond)
	Legal	216 x 356 mm (8.5 x 14 inches)		
	US Folio	216 x 330 mm (8.5 x 13 inches)		
	A4	210 x 297 mm (8.27 x 11.69 inches)		
	Oficio	216 x 343 mm (8.5 x 13.5 inches)		
	JIS B5	182 x 257 mm (7.17 x 10.12 inches)		
	ISO B5	176 x 250 mm (6.93 x 9.84 inches)		
	Executive	184 x 267 mm (7.25 x 10.5 inches)		
	A5	148 x 210 mm (5.83 x 8.27 inches)		
	A6	105 x 148 mm (4.13 x 5.83 inches)		

Specifications

Type	Size	Dimensions	Print media weight/Capacity ^a	
			Tray	Manual feeder ^b
Envelope	Envelope Monarch	98 x 191 mm (3.87 x 7.5 inches)	Not available in tray	60 to 220 g/m ² (16 to 59 lbs bond)
	Envelope No. 10	105 x 241 mm (4.12 x 9.5 inches)		
	Envelope DL	110 x 220 mm (4.33 x 8.66 inches)		
	Envelope C5	162 x 229 mm (6.38 x 9.02 inches)		
	Envelope C6	114 x 162 mm (4.49 x 6.38 inches)		
Thick paper	Refer to the Plain paper section	Refer to the Plain paper section	91 to 105 g/m ² (24 to 28 lbs bond)	91 to 105 g/m ² (24 to 28 lbs bond)
Thicker paper	Refer to the Plain paper section	Refer to the Plain paper section	Not available in tray	164 to 220 g/m ² (44 to 59 lbs bond)
Thin paper	Refer to the Plain paper section	Refer to the Plain paper section	60 to 70 g/m ² (16 to 19 lbs bond)	60 to 70 g/m ² (16 to 19 lbs bond)
Transparency	Letter, A4	Refer to the Plain paper section	Not available in tray	138 to 146 g/m ² (37 to 39 lbs bond)
Labels ^c	Letter, Legal, US Folio, A4, JIS B5, ISO B5, Executive, A5	Refer to the Plain paper section	Not available in tray	120 to 150 g/m ² (32 to 40 lbs bond)
Card stock	Letter, Legal, US Folio, A4, JIS B5, ISO B5, Executive, A5, Postcard 4x6	Refer to the Plain paper section	121 to 163 g/m ² (32 to 43 lbs bond)	121 to 163 g/m ² (32 to 43 lbs bond)

Specifications

Type	Size	Dimensions	Print media weight/Capacity ^a	
			Tray	Manual feeder ^b
Bond paper	Refer to the Plain paper section	Refer to the Plain paper section	106 to 120 g/m ² (28 to 32 lbs bond)	106 to 120 g/m ² (28 to 32 lbs bond)
Minimum size (custom)		<ul style="list-style-type: none"> • Manual feeder: 76 x 127 mm (3 x 5 inches) • Tray: 105 x 148.5 mm (4.13 x 5.85 inches) 	60 to 163 g/m ² (16 to 43 lbs bond) ^{d, e}	
Maximum size (custom)		216 x 356 mm (8.5 x 14 inches)		

a. Maximum capacity may differ depending on media weight, thickness, and environmental conditions.

b. 1 sheet for manual feeder.

c. The smoothness of the labels used in this machine is 100 to 250 (sheffield). This means the numeric level of smoothness.

d. The paper types available in the manual feeder: Plan, Thick, Thicker, Thin, Cotton, Colored, Pre-printed, Recycled, Envelope, Transparency, Labels, Cardstock, Bond, Archive

e. The paper types available in tray: Plan, Thick, Thin, Recycled, Cardstock, Bond, Archive

Specifications

System requirements

Microsoft® Windows®

Operating system	Requirement (recommended)		
	CPU	RAM	free HDD space
Windows® 2000	Intel® Pentium® II 400 MHz (Pentium III 933 MHz)	64 MB (128 MB)	600 MB
Windows® XP	Intel® Pentium® III 933 MHz (Pentium IV 1 GHz)	128 MB (256 MB)	1.5 GB
Windows Server® 2003	Intel® Pentium® III 933 MHz (Pentium IV 1 GHz)	128 MB (512 MB)	1.25 GB to 2 GB
Windows Server® 2008	Intel® Pentium® IV 1 GHz (Pentium IV 2 GHz)	512 MB (2 GB)	10 GB
Windows Vista®	Intel® Pentium® IV 3 GHz	512 MB (1 GB)	15 GB
Windows® 7	Intel® Pentium® IV 1 GHz 32-bit or 64-bit processor or higher	1 GB (2 GB)	16 GB
	<ul style="list-style-type: none">• Support for DirectX® 9 graphics with 128 MB memory (to enable the Aero theme).• DVD-R/W Drive		
Windows Server® 2008 R2	Intel® Pentium® IV 1 GHz (x86) or 1.4 GHz (x64) processors (2 GHz or faster)	512 MB (2 GB)	10 GB



- Internet Explorer 6.0 or higher is the minimum requirement for all Windows operating systems.
- Users who have administrator rights can install the software.
- **Windows Terminal Services** is compatible with your machine.
- For **Windows 2000, Services Pack 4** or higher is required.

Specifications

Macintosh

Operating system	Requirements (Recommended)		
	CPU	RAM	Free HDD space
Mac OS X 10.4	<ul style="list-style-type: none">• Intel® processors• PowerPC G4/G5	<ul style="list-style-type: none">• 128 MB for a powerPC based Mac (512 MB)• 512 MB for an Intel-based Mac (1 GB)	1 GB
Mac OS X 10.5	<ul style="list-style-type: none">• Intel® processors• 867 MHz or faster Power PC G4/G5	512 MB (1 GB)	1 GB
Mac OS X 10.6	<ul style="list-style-type: none">• Intel® processors	1 GB (2 GB)	1 GB
Mac OS X 10.7 ~ 10.10	<ul style="list-style-type: none">• Intel® processors	2 GB	4 GB

Specifications

Linux

Items	Requirements
Operating system	Redhat® Enterprise Linux WS 4, 5 (32/64 bit) Fedora 5 ~ 13 (32/64 bit) SuSE Linux 10.1 (32 bit) OpenSuSE® 10.2, 10.3, 11.0, 11.1, 11.2 (32/64 bit) Mandriva 2007, 2008, 2009, 2009.1, 2010 (32/64 bit) Ubuntu 6.06, 6.10, 7.04, 7.10, 8.04, 8.10, 9.04, 9.10, 10.04 (32/64 bit) SuSE Linux Enterprise Desktop 10, 11 (32/64 bit) Debian 4.0, 5.0 (32/64 bit)
CPU	Pentium IV 2.4GHz (Intel Core™2)
RAM	512 MB (1 GB)
Free HDD space	1 GB (2 GB)

Specifications

Unix

Items	Requirements
Operating system	Sun Solaris 9, 10 (x86, SPARC) HP-UX 11.0, 11i v1, 11i v2, 11i v3 (PA-RISC, Itanium) IBM AIX 5.1, 5.2, 5.3, 5.4
Free HDD space	Up to 100 MB

Specifications

Network environment

You need to set up the network protocols on the machine to use it as your network machine. The following table shows the network environments supported by the machine.

Items	Specifications
Network interface	<ul style="list-style-type: none">• Ethernet 10/100 Base-TX Wired Lan
Network operating system	<ul style="list-style-type: none">• Windows 2000/Server 2003 /Server 2008/XP/Vista/7/Server 2008 R2• Various Linux OS• Mac OS X 10.4 ~ 10.10• Unix
Network protocols	<ul style="list-style-type: none">• TCP/IPv4• DHCP, BOOTP• DNS, WINS, Bonjour, SLP, UPnP• Standard TCP/IP Printing (RAW), LPR, IPP, WSD• SNMPv 1/2/3, HTTP• TCP/IPv6 (DHCP, DNS, RAW, LPR, SNMPv 1/2/3, HTTP)

Dell technical support policy

Technician-assisted technical support requires the cooperation and participation of the customer in the troubleshooting process and provides for restoration of the Operating System, application software, and hardware drivers to the original default configuration as shipped from Dell, as well as the verification of appropriate functionality of the printer and all Dell-installed hardware. In addition to this technician assisted technical support, online technical support is available at Dell Support. Additional technical support options may be available for purchase.

Dell provides limited technical support for the printer and any Dell-installed software and peripherals. Support for third-party software and peripherals is provided by the original manufacturer, including those purchased and/or installed through Software & Peripherals (DellWare), ReadyWare, and Custom Factory Integration (CFI/DellPlus).

Contacting Dell

You can access Dell Support at **support.dell.com**. Select your region on the WELCOME TO DELL SUPPORT page, and fill in the requested details to access help tools and information.

You can contact Dell electronically using the following addresses:

- World Wide Web
 - **www.dell.com/**
 - **www.dell.com/ap/** (Asian/Pacific countries only)
 - **www.dell.com/jp/** (Japan only)
 - **www.euro.dell.com** (Europe only)
 - **www.dell.com/la/** (Latin American and Caribbean countries)
 - **www.dell.ca** (Canada only)
- Anonymous file transfer protocol (FTP)
 - **ftp.dell.com**

Log in as user: anonymous, and use your email address as your password.
- Electronic Support Service
 - **mobile_support@us.dell.com**
 - **support@us.dell.com**
 - **la-techsupport@dell.com** (Latin America and Caribbean countries only)
 - **apsupport@dell.com** (Asian/Pacific countries only)
 - **support.jp.dell.com** (Japan only)

- **support.euro.dell.com** (Europe only)
- Electronic Quote Service
 - **apmarketing@dell.com** (Asian/Pacific countries only)
 - **sales_canada@dell.com** (Canada only)

Warranty and return policy

Dell Inc. ("Dell") manufactures its hardware products from parts and components that are new or equivalent to new in accordance with industry-standard practices. For information about the Dell warranty for your printer, refer to the *Product Information Guide*.

Copyright

Information in this document is subject to change without notice.

©2012 Dell Inc. All rights reserved.

Reproduction of these materials in any manner whatsoever without the written permission of Dell Inc. is strictly forbidden.

Trademarks used in this text: *Dell*, the *Dell* logo, and *Dell Toner Management System* are trademarks of Dell Inc.; *Microsoft*, *Windows*, *Windows Vista*, and *Windows Server* are registered trademarks of Microsoft Corporation in the United States and/or other countries; *Adobe* and *Acrobat Reader* are either registered trademarks or trademarks of Adobe Systems Incorporated in the United States and/or other countries.

iPad, iPhone, iPod touch, TrueType, Mac and Mac OS are trademarks of Apple Inc., registered in the U.S and other countries. AirPrint and the AirPrint logo are trademarks of Apple Inc.

Other trademarks and trade names may be used in this document to refer to the entities claiming the marks and names of their products.

Dell Inc. disclaims any proprietary interest in trademarks and trade names other than its own.

Google Cloud Print is a trademark of Google Inc.

Google, Picasa, Google Docs, Android and Gmail are either registered trademarks or trademarks of Google Inc.

Refer to the '**LICENSE.txt**' file in the provided CD-ROM for the open source license information.

REV. 4.00

User's Guide

Dell B1265dnf

ADVANCED

This guide provides information about installation, advanced configuration, operation and troubleshooting on various OS environments.

Some features may not be available depending on models or countries.

BASIC

This guide provides information concerning installation, basic operation and troubleshooting on windows.



1. Software Installation

Installation for Macintosh	110
Reinstallation for Macintosh	112
Installation for Linux	113
Reinstallation for Linux	114



2. Using a Network-Connected Machine

Useful network programs	116
Wired network setup	117
Installing driver over the network	120
IPv6 configuration	126
AirPrint	129
Google Cloud Print™	130



3. Useful Setting Menus

Before you begin reading a chapter	134
Print menu	135
Copy menu	136
Fax menu	140

System setup

143



4. Special Features

Altitude adjustment	150
Entering various characters	151
Setting up the fax address book	152
Printing features	155
Scan features	167
Fax features	174



5. Useful Management Tools

Using Firmware update utility	184
Using Dell Supplies Ordering Utility	185
Using Embedded Web Service	186
Using Dell Printer Manager	188
Using Dell Printer Status	191
Using the Linux Unified Driver Configurator	193



6. Troubleshooting

Paper feeding problems	198
------------------------	-----

ADVANCED

Power and cable connecting problems	199
Printing problems	200
Printing quality problems	203
Copying problems	211
Scanning problems	212
Faxing problems	214
Operating system problems	216



1. Software Installation

This chapter provides instructions for installing essential and helpful software for use in an environment where the machine is connected via a cable. A locally connected machine is a machine directly attached to your computer using the cable. If your machine is attached to a network, skip the following steps below and go on to installing a network connected machine's driver (see "Installing driver over the network" on page 120).

- **Installation for Macintosh** **110**
- **Reinstallation for Macintosh** **112**
- **Installation for Linux** **113**
- **Reinstallation for Linux** **114**



- If you are a Windows OS user, refer to the Basic Guide for installing the machine's driver (see "Installing the driver locally" on page 21).
- Only use a USB cable no longer than 3 meter (118 inches).

Installation for Macintosh

- 1 Make sure that the machine is connected to your computer and powered on.
- 2 Insert the supplied software CD into your CD-ROM drive.
- 3 Double-click the CD-ROM icon that appears on your Macintosh desktop.
 - For Mac OS X 10.8 or higher, double-click the CD-ROM that appears on **Finder**.
- 4 Double-click the **MAC_Installer** folder > **Installer OS X** icon.
- 5 Click **Continue**.
- 6 Read the license agreement and click **Continue**.
- 7 Click **Agree** to agree to the license agreement.
- 8 When the message that warns that all applications will close on your computer appears, click **Continue**.
- 9 Click **Continue** on the **User Options Pane**.
- 10 Click **Install**. All components necessary for machine operations will be installed.
If you click **Customize**, you can choose individual components to install.
- 11 Enter the password and click **OK**.
- 12 Installing software requires you to restart your computer. Click **Continue Installation**.
- 13 After the installation is finished, click **Restart**.
- 14 Open the **Applications** folder > **Utilities** > **Print Setup Utility**.
 - For Mac OS X 10.5 or higher, open the **Applications** folder > **System Preferences** and click **Print & Fax**.
- 15 Click **Add** on the **Printer List**.
 - For Mac OS X 10.5 or higher, click the “+” folder icon; a display window will pop up.
- 16 Click **Default Browser** and find the USB connection.
 - For Mac OS X 10.5 or higher, click **Default** and find the USB connection.
- 17 For Mac OS X 10.4, if Auto Select does not work properly, select **Dell** in **Print Using** and your machine name in **Model**.
 - For Mac OS X 10.5 or higher, if Auto Select does not work properly, select **Select a driver to use...** and your machine name in **Print Using**.Your machine appears on the **Printer List**, and is set as the default machine.
- 18 Click **Add**.

Installation for Macintosh



To install the fax driver:

- a** Open the **Applications** folder > **Dell** > **Fax Queue Creator**.
- b** Your machine appears on the **Printer List**
- c** Select machine to use and click **Create** button

Reinstallation for Macintosh

If the printer driver does not work properly, uninstall the driver and reinstall it.

- 1 Make sure that the machine is connected to your computer and powered on.
- 2 Insert the supplied software CD into your CD-ROM drive.
- 3 Double-click the CD-ROM icon that appears on your Macintosh desktop.
- 4 Double-click the **MAC_Installer** folder > **Uninstaller OS X** icon.
- 5 Enter the password and click **OK**.
- 6 When the uninstall is done, click **OK**.



If a machine has already been added, delete it from the **Print Setup Utility** or **Print & Fax**.

Installation for Linux

You need to download Linux software packages from the Dell website to install the printer software (www.support.dell.com).

Installing the Unified Linux Driver

- 1 Make sure that the machine is connected to your computer and powered on.
- 2 When the **Administrator Login** window appears, type "root" in the **Login** field and enter the system password.



You must log in as a super user (root) to install the machine software. If you are not a super user, ask your system administrator.

- 3 From the Dell website, download the Unified Linux Driver package to your computer.
- 4 Right-click the **Unified Linux Driver** package and extract the package.
- 5 Double click **cdroot > autorun**.
- 6 When the welcome screen appears, click **Next**.
- 7 When the installation is complete, click **Finish**.

The installation program added the Unified Driver Configurator desktop icon and the Unified Driver group to the system menu for your convenience. If you have any difficulties, consult the on-screen help that is available through your system menu or from the driver package Windows applications, such as **Unified Driver Configurator** or **Image Manager**.

Reinstallation for Linux

If the printer driver does not work properly, uninstall the driver and reinstall it.

- 1 Make sure that the machine is connected to your computer and powered on.
- 2 When the **Administrator Login** window appears, type "root" in the **Login** field and enter the system password.
You must log in as a super user (root) to uninstall the printer driver. If you are not a super user, ask your system administrator.
- 3 Click the icon at the bottom of the desktop. When the Terminal screen appears, type in the following.

```
[root@localhost root]#cd /opt/Dell/mfp/uninstall/  
[root@localhost uninstall]#./uninstall.sh
```
- 4 Click **Uninstall**.
- 5 Click **Next**.
- 6 Click **Finish**.



2. Using a Network-Connected Machine

This chapter gives you step-by-step instructions for setting up a network connected machine and software.

- **Useful network programs** 116
- **Wired network setup** 117
- **Installing driver over the network** 120
- **IPv6 configuration** 126
- **AirPrint** 129
- **Google Cloud Print™** 130



Supported optional devices and features may differ according to your model (see "Features" on page 6).

Useful network programs

There are several programs available to setup the network settings easily in a network environment. For the network administrator especially, managing several machines on the network is possible.



Before using the programs below, set the IP address first.

Embedded Web Service

The web server embedded on your network machine allows you to do the following tasks (see "Using Embedded Web Service" on page 186).

- Check the supplies information and status.
- Customize machine settings.
- Set the email notification option. When you set this option, the machine status (toner cartridge shortage or machine error) will be sent to a certain person's email automatically.
- Configure the network parameters necessary for the machine to connect to various network environments.

SetIP wired network setup

This utility program allows you to select a network interface and manually configure the IP addresses for use with the TCP/IP protocol.

- See "IPv4 configuration using SetIP (Windows)" on page 117.
- See "IPv4 configuration using SetIP (Macintosh)" on page 118.
- See "IPv4 configuration using SetIP (Linux)" on page 119.



- The machine that does not support the network interface, it will not be able to use this feature (see "Rear view" on page 17).
- TCP/IPv6 is not supported by this program.

Wired network setup

Printing a network configuration report

You can print **Network Configuration Report** from the machine's control panel that will show the current machine's network settings. This will help you to set up a network.

Press the  (**Menu**) button on the control panel and select **Network > Network Config..**

Using this **Network Configuration Report**, you can find your machine's MAC address and IP address.

For example:

- MAC Address: 00:15:99:41:A2:78
- IP Address: 169.254.192.192

Setting IP address



- The machine that does not support the network interface, it will not be able to use this feature (see "Rear view" on page 17).
- TCP/IPv6 is not supported by this program.

First, you have to set up an IP address for network printing and managements. In most cases a new IP address will be automatically assigned by a DHCP (Dynamic Host Configuration Protocol) server located on the network.

IPv4 configuration using SetIP (Windows)

Before using the SetIP program, disable the computer firewall from **Control Panel > Security Center > Windows Firewall**.

- 1 Install this program from the supplied CD-ROM by double-click **Application > SetIP > Setup.exe**.
- 2 Follow the instructions in the installation window.
- 3 Connect your machine to the network with a network cable.
- 4 Turn on the machine.
- 5 From the Windows **Start** menu, select **All Programs > Dell > Printers > SetIP > SetIP**.
- 6 Click the  icon (third from left) in the SetIP window to open the TCP/IP configuration window.

Wired network setup

- 7 Enter the machine's new information into the configuration window as follows. In a corporate intranet, you may need to have this information assigned by a network manager before proceeding.

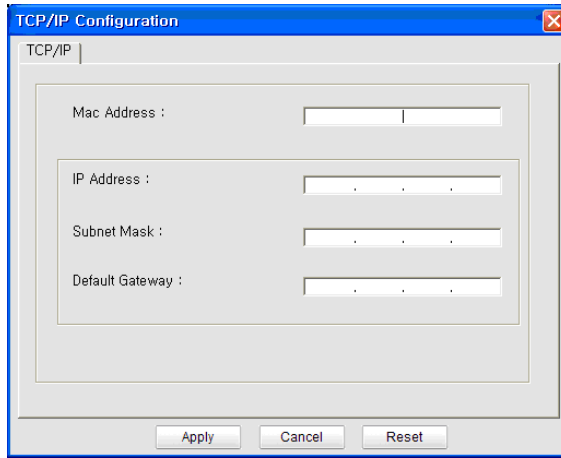

-  Find the machine's MAC address from the **Network Configuration Report** (see "Printing a network configuration report" on page 117) and enter it without the colons. For example, 00:15:99:29:51:A8 becomes 0015992951A8.

- 8 Click **Apply**, and then click **OK**. The machine will automatically print the **Network Configuration Report**. Confirm that all the settings are correct.

IPv4 configuration using SetIP (Macintosh)

Before using the SetIP program, disable the computer firewall from **System Preferences > Security > Firewall**.



The following instructions may vary from your model.

- 1 Connect your machine to the network with a network cable.
- 2 Insert the Installation CD-ROM, and open the disk window, select **MAC_Installer > MAC_Printer > SetIP > SetIPApplet.html**.
- 3 Double-click the file and **Safari** will automatically open, then select **Trust**. The browser will open the **SetIPApplet.html** page that shows the printer's name and IP address information.
- 4 Click the  icon (third from left) in the SetIP window to open the TCP/IP configuration window.
- 5 Enter the machine's new information into the configuration window. In a corporate intranet, you may need to have this information assigned by a network manager before proceeding.

Wired network setup



Find the machine's MAC address from the **Network Configuration Report** (see "Printing a network configuration report" on page 117) and enter it without the colons. For example, 00:15:99:29:51:A8 becomes 0015992951A8.

6 Select **Apply**, then **OK**, and **OK** again.

7 Quit **Safari**.



Find the machine's MAC address from the **Network Configuration Report** (see "Printing a network configuration report" on page 117) and enter it without the colons. For example, 00:15:99:29:51:A8 becomes 0015992951A8.

5 The machine will automatically print the **Network Configuration Report**.

IPv4 configuration using SetIP (Linux)

Before using the SetIP program, disable the computer firewall from **System Preferences** or **Administrator**.



The following instructions may vary from your model or operating systems.

1 Open `/opt/Dell/mfp/share/utils/`.

2 Double-click the **SetIPApplet.html** file.

3 Click to open the TCP/IP configuration window.

4 Enter the machine's new information into the configuration window. In a corporate intranet, you may need to have this information assigned by a network manager before proceeding.

Installing driver over the network



The machine that does not support the network interface, it will not be able to use this feature (see "Rear view" on page 17).

Windows

- 1 Make sure that the machine is connected to the network and powered on. Also, your machine's IP address should have been set.



If the "**Found New Hardware Wizard**" appears during the installation procedure, click **Cancel** to close the window.

- 2 Insert the supplied software CD into your CD-ROM drive.
The software CD should automatically run and an installation window will appear.
If the installation window does not appear, click **Start** > **All programs** > **Accessories** > **Run**.
X:**Setup.exe** replacing "X" with the letter, which represents your CD-ROM drive and click **OK**.

- 3 Select **Next**.

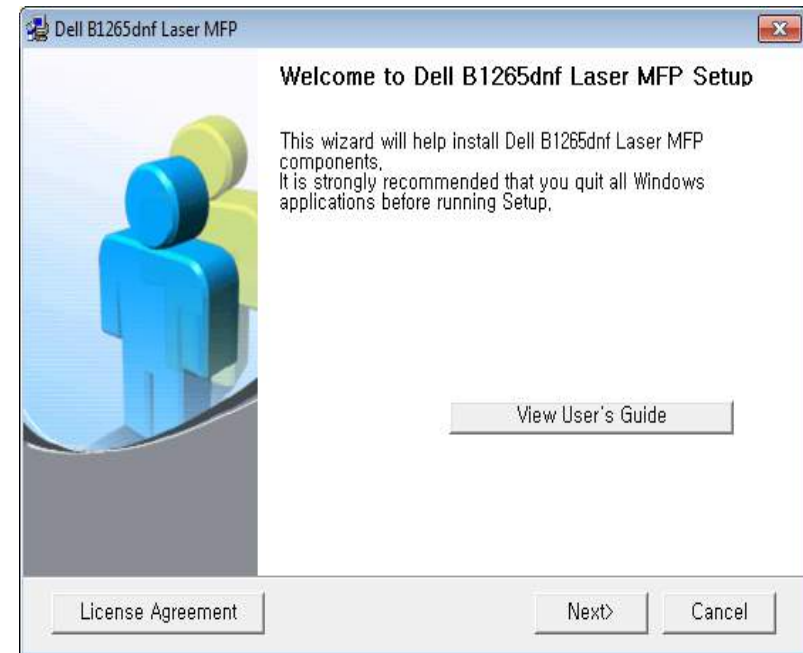

Installing driver over the network

- 4 Select **Connect a network printer to the computer**. Click **Next**.

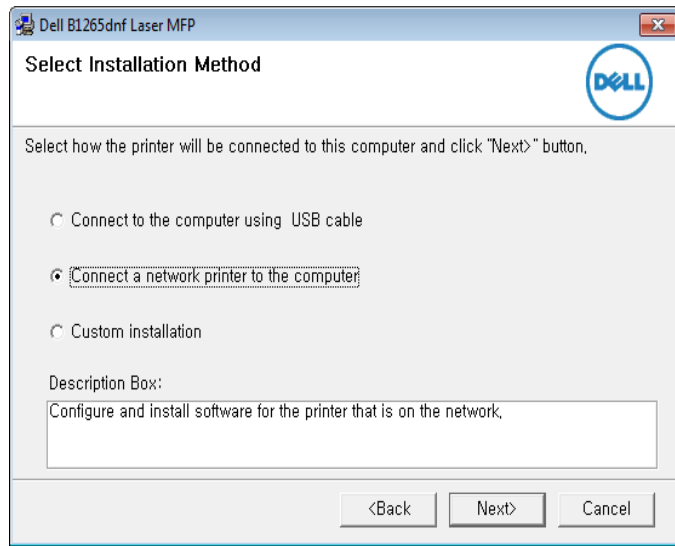

 The **Custom installation** allows you to select the machine's connection and choose individual components to install. Follow the instructions on the window.

- 5 The searched machines will be shown on the screen. Select the one you wish to use and click **Next**.

 If you cannot find your machine in network, turn off the firewall and click **Update**. For Windows operating system, **Start > Control Panel** and start windows firewall, and set this option unactivated. For other operating system, refer to its on-line guide.

- 6 Follow the instructions in the installation window.

Macintosh

- 1 Make sure that the machine is connected to your network and powered on.
- 2 Insert the supplied software CD into your CD-ROM drive.
- 3 Double-click the CD-ROM icon that appears on your Macintosh desktop.
 - For Mac OS X 10.8 or higher, double-click the CD-ROM that appears on **Finder**.
- 4 Double-click the **MAC_Installer** folder > **Installer OS X** icon.
- 5 Click **Continue**.
- 6 Read the license agreement and click **Continue**.
- 7 Click **Agree** to agree to the license agreement.
- 8 When the message which warns that all applications will close on your computer appears, click **Continue**.
- 9 Click **Continue** on the **User Options Pane**.

Installing driver over the network



If you have not set the IP address yet, click Set IP address and refer to "IPv4 configuration using SetIP (Macintosh)" on page 118.

- 10 Click **Install**. All components necessary for machine operations will be installed.
If you click **Customize**, you can choose individual components to install.
- 11 Enter the password and click **OK**.
- 12 Installing software requires you to restart your computer. Click **Continue Installation**.
- 13 After the installation is finished, click **Restart**.
- 14 Open the **Applications** folder > **Utilities** > **Print Setup Utility**.
 - For Mac OS X 10.5 or higher, open the **Applications** folder > **System Preferences** and click **Print & Fax**.
- 15 Click **Add** on the **Printer List**.
 - For Mac OS X 10.5 or higher, click the "+" icon. A display window will pop up.
- 16 For Mac OS X 10.4, click **IP Printer**.
 - For Mac OS X 10.5 or higher, click **IP**.
- 17 Select **HP Jetdirect - Socket** in **Protocol**.



When printing a document containing many pages, printing performance may be enhanced by choosing **Socket** for **Printer Type** option.

- 18 Enter the machine's IP address in the **Address** input field.
- 19 Enter the queue name in the **Queue** input field. If you cannot determine the queue name for your machine server, try using the default queue first.
- 20 For Mac OS X 10.4, if Auto Select does not work properly, select **Dell** in **Print Using** and your machine name in **Model**.
 - For Mac OS X 10.5 or higher, if Auto Select does not work properly, choose **Select Printer Software** and your machine name in **Print Using**.
- 21 Click **Add**.
Your machine appears in the **Printer List**, and is set as the default machine.

Linux

You need to download Linux software packages from the Dell website to install the printer software (www.dell.com or support.dell.com > find your product > Support or Downloads).

Installing driver over the network

Install the Linux driver and add network printer

- 1 Make sure that the machine is connected to your network and powered on. Also, your machine's IP address should have been set.
- 2 Download the Unified Linux Driver package from the Dell website.
- 3 Extract the UnifiedLinuxDriver.tar.gz file and open the new directory.
- 4 Double-click the **Linux** folder > **install.sh** icon.
- 5 The Dell installer window opens. Click **Continue**.
- 6 The add printer wizard window opens. Click **Next**.
- 7 Select network printer and click **Search** button.
- 8 The machine's IP address and model name appears on list field.
- 9 Select your machine and click **Next**.
- 10 Input the printer description and **Next**.
- 11 After the machine is added, click **Finish**.
- 12 When installation is done, click **Finish**.

Add a network printer

- 1 Double-click the **Unified Driver Configurator**.
- 2 Click **Add Printer**.
- 3 The **Add printer wizard** window opens. Click **Next**.
- 4 Select **Network printer** and click the **Search** button.
- 5 The printer's IP address and model name appears on list field.
- 6 Select your machine and click **Next**.
- 7 Enter the printer description and click **Next**.
- 8 After the machine is added, click **Finish**.

UNIX



- Make sure your machine supports the UNIX operating system before installing the UNIX printer driver (see "Operating System" on page 6).
- The commands are marked with "", when typing the commands, do not type "".

Installing driver over the network

To use the UNIX printer driver, you have to install the UNIX printer driver package first, then setup the printer.

Installing the UNIX printer driver package

The installation procedure is common for all variants of UNIX OS mentioned.

- 1 From the Dell website, download and unpack the UNIX Printer Driver package to your computer.
- 2 Acquire root privileges.
"su -"
- 3 Copy the appropriate driver archive to the target UNIX computer.

 See administration guide of your UNIX OS for details.

- 4 Unpack the UNIX printer driver package.
For example, on IBM AIX, use the following commands.
"gzip -d < enter the package name | tar xf -"
- 5 Go to the unpacked directory.

- 6 Run the install script.
"./install -i"

install is the installer script file which is used to install or uninstall the UNIX Printer Driver package.

Use "**chmod 755 install**" command to give the permission to the installer script.

- 7 Execute the ". /install -c" command to verify installation results.
- 8 Run "**installprinter**" from the command line. This will bring up the **Add Printer Wizard** window. Setup the printer in this window referring to the following procedures.



On some UNIX OS, for example on Solaris 10, just added printers may not be enabled and/or may not accept jobs. In this case run the following two commands on the root terminal:

"**accept <printer_name>**"

"**enable <printer_name>**"

Installing driver over the network

Uninstalling the printer driver package



The utility should be used to delete the printer installed in the system.

- a** Run “**uninstallprinter**” command from the terminal.
It will open the **Uninstall Printer Wizard**.
The installed printers are listed in the drop-down list.
- b** Select the printer to be deleted.
- c** Click **Delete** to delete the printer from the system.
- d** Execute the “**./install -d**” command to uninstall the whole package.
- e** To verify removal results, execute the “**./install -c**” command.

To re-install it, use the command “**./install**” to reinstall the binaries.

Setting up the printer

To add the printer to your UNIX system, run ‘installprinter’ from the command line. This will bring up the Add Printer Wizard window. Setup the printer in this window according to the following steps:

- 1** Type the name of the printer.
- 2** Select the appropriate printer model from the model list.
- 3** Enter any description corresponding to the type of the printer in the **Type** field. This is optional.

- 4** Specify any printer description in the **Description** field. This is optional.
- 5** Specify the printer location in the **Location** field.
- 6** Type the IP address or DNS name of the printer in the **Device** textbox for network-connected printers. On IBM AIX with **jetdirect Queue type**, only the DNS name is possible-numeric IP address is not allowed.
- 7** **Queue type** shows the connection as **lpd** or **jetdirect** in the corresponding list box. Additionally, **usb** type is available on Sun Solaris OS.
- 8** Select **Copies** to set the number of copies.
- 9** Check the **Collate** option to receive copies already sorted.
- 10** Check the **Reverse Order** option to receive copies in the reverse order.
- 11** Check the **Make Default** option to set this printer as default.
- 12** Click **OK** to add the printer.

IPv6 configuration



IPv6 is supported properly only in Windows Vista or higher.



If the IPv6 network seems to not be working, set all the network setting to the factory defaults and try again.

In the IPv6 network environment, follow the next procedure to use the IPv6 address.

From the control panel

- 1 Connect your machine to the network with a network cable.
- 2 Turn on the machine.
- 3 Print a **Network Configuration Report** that will check IPv6 addresses (see "Printing a network configuration report" on page 117).
- 4 Select **Start > Control Panel > Printers and Faxes**.
- 5 Click **Add a printer** in the left pane of the **Printers and Faxes** windows.
- 6 Click **Add a local printer** in the **Add Printer** windows.

7

The **Add Printer Wizard** window appears. Follow the instructions in the window.



If the machine does not work in the network environment, activate IPv6. Refer to the next section followed by.

Activating IPv6

- 1 Press the  (**Menu**) button on the control panel.
- 2 Press **Network > TCP/IP (IPv6) > IPv6 Activate**.
- 3 Select **On** and press **OK**.
- 4 Turn the machine off and turn it on again.
- 5 Reinstall your printer driver.

IPv6 configuration

Setting IPv6 addresses

The machine supports the following IPv6 addresses for network printing and managements.

- **Link-local Address:** Self-configured local IPv6 address (Address starts with FE80).
- **Stateless Address:** Automatically configured IPv6 address by a network router.
- **Stateful Address:** IPv6 address configured by a DHCPv6 server.
- **Manual Address:** Manually configured IPv6 address by a user.

DHCPv6 address configuration (Stateful)

If you have a DHCPv6 server on your network, you can set one of the following options for default dynamic host configuration.

- 1 Press the  (**Menu**) button on the control panel.
- 2 Press **Network > TCP/IP (IPv6) > DHCPv6 Config**.
- 3 Press **OK** to select the required value you want.
 - **DHCPv6 Addr.:** Always use DHCPv6 regardless of router request.
 - **DHCPv6 Off:** Never use DHCPv6 regardless of router request.
 - **Router:** Use DHCPv6 only when requested by a router.

From the Embedded Web Service



For models that do not have the display screen on the control panel, you need to access **Embedded Web Service** first using the IPv4 address and follow the below procedure to use IPv6.

- 1 Access a web browser, such as Internet Explorer, from Windows. Enter the machine IP address (http://xxx.xxx.xxx.xxx) in the address field and press the Enter key or click **Go**.
- 2 If it's your first time logging into **Embedded Web Service** you need to log-in as an administrator. Type in the below default ID and password.
 - **ID: admin**
 - **Password: dell00000**
- 3 When the **Embedded Web Service** window opens, move the mouse cursor over the **Settings** of the top menu bar and then click **Network Settings**.
- 4 Click **TCP/IPv6** on the left pane of the website.
- 5 Check the **IPv6 Protocol** check box to activate IPv6.
- 6 Check the **Manual Address** check box. Then, the **Address/Prefix** text box is activated.

IPv6 configuration

- 7 Enter the rest of the address (e.g.,:3FFE:10:88:194::**AAAA**. "A" is the hexadecimal 0 through 9, A through F).
- 8 Choose the DHCPv6 configuration.
- 9 Click the **Apply** button.

Using Embedded Web Service

- 1 Start a web browser, such as Internet Explorer, that supports IPv6 addressing as a URL.
- 2 Select one of the IPv6 addresses (**Link-local Address, Stateless Address, Stateful Address, Manual Address**) from **Network Configuration Report** (see "Printing a network configuration report" on page 117).
- 3 Enter the IPv6 addresses (e.g.,: http://[FE80::215:99FF:FE66:7701]).



Address must be enclosed in '['] brackets.

AirPrint



AirPrint allows you to wirelessly print directly from an iPhone, iPad, or iPod touch running iOS 4.2 or later.

Setting up AirPrint

Bonjour(mDNS) and IPP protocols are required on your machine to use the **AirPrint** feature. You can enable the **AirPrint** feature by one of the following methods.

- 1 Check whether the machine is connected to the network.
- 2 Start a web browser such as Internet Explorer, Safari, or Firefox and enter your machine's new IP address in the browser window.

For example,



- 3 Click **Login** in the upper right of the Embedded Web Service website.
- 4 Type in the **ID** and **Password**, then click **Login**. If it's your first time logging into Embedded Web Service, type in the below default ID and password.
 - **ID: admin**
 - **Password: dell00000**

- 5 When the **Embedded Web Service** window opens, click **Settings > Network Settings**.
- 6 Click **Raw TCP/IP, LPR, IPP or mDNS**.
You can enable the IPP protocol or mDNS protocol.

Printing via AirPrint

For example, the iPad manual provides these instructions:

- 1 Open your email, photo, web page, or document you want to print.
- 2 Touch the action icon ().
- 3 Select **your printer driver name** and option menu to set up.
- 4 Touch **Print** button. Print it out.



Cancelling print job: To cancel the printing job or view the print summary, click the print center icon () in multitasking area. You can click cancel in the print center.

Google Cloud Print™

Google Cloud Print™ is a service that allows you to print to a printer using your smart phone, tablet, or any other web-connected devices. Just register your Google account with the printer, and you are ready to use the Google Cloud Print™ service. You can print your document or email with Chrome OS, Chrome browser, or a Gmail™/ Google Docs™ application on your mobile device, so you don't need to install the printer driver on the mobile device. Refer to the Google website (<http://support.google.com/cloudprint>) for more information about Google Cloud Print™.

Registering your Google account to the printer



- Make sure the printer machine is turned on and connected to a wired or wireless network that has access to the Internet.
- You should create your Google account in the advance.

- 1 Open the Chrome browser.
- 2 Visit www.google.com.
- 3 Sign in to the Google website with your Gmail™ address.
- 4 Enter your printer's IP address in the address field and press the Enter key or click **Go**.

5 Click **Login** in the upper right corner of the Embedded Web Service website.

6 If it's your first time logging into **Embedded Web Service** you need to log-in as an administrator. Type in the below default **ID** and **Password**. We recommend you to change the default password for security reasons.

- **ID: admin**
- **Password: dell00000**



If the network environment is using a proxy server, you need to configure the proxy's IP and port number from **Settings > Network Settings > Google Cloud Print > Proxy Setting**. Contact your network service provider or network administrator for more information.

7 When the **Embedded Web Service** window opens, click **Settings > Network Settings > Google Cloud Print**.

8 Enter your printer's name and description.

9 Click **Register**.
The confirmation pop-up window appears.



If you set the browser to block pop-ups, the confirmation window will not appear. Allow the site to show pop-ups.

Google Cloud Print™

10 Click **Finish printer registration**.

11 Click **Manage your printers**.

Now your printer is registered with Google Cloud Print™ service.

Google Cloud Print™-ready devices will appear in the list.

Printing with Google Cloud Print™

The printing procedure varies depending on the application or the device you are using. You can see the application list that supports Google Cloud Print™ service.



Make sure the printer is turned on and connected to a wired or wireless network that has access to the Internet.

To share your printer with your freinds, please refer to the following web site.
<http://support.google.com/chromeos/bin/answer.py?hlen&answer1241064>

Printing from an application on mobile device

The following steps are an example of using the Google Docs™ app from Android mobile phone.

1 Install the Cloud Print application on your mobile device.



If you do not have the application, download it from the application store such as Android Market or App Store.

2 Access the Google Docs™ application from your mobile device and tap on the  icon to select document.

3 Tap the option  button of the document that you want to print.

4 Tap the send  button.

5 Tap the Cloud Print  button.

6 Set the printing options if you want.

7 Tap **Click here to Print**.

Printing from the Chrome browser

The following steps are an example of using the Chrome browser.

1 Run Chrome.

2 Open the document or email that you want to print.

Google Cloud Print™

- 3 Click the wrench icon  in the browser's top right corner.
- 4 Click **Print**. A new tab for printing appears.
- 5 Select **Print with Google Cloud Print**.
- 6 Click the **Print** button.



3. Useful Setting Menus

This chapter explains how to browse the current status of your machine, and the method of setting for advanced machine setup.

- **Before you begin reading a chapter** 134
- **Print menu** 135
- **Copy menu** 136
- **Fax menu** 140
- **System setup** 143





Before you begin reading a chapter

This chapter explains all the features available for this series' models to help users easily understand the features.

You can check the features available for each model in the Basic Guide (see "Menu overview" on page 25).

The following are tips for using this chapter

- The control panel provides access to various menus to set up the machine or use the machine's functions. These menus can be accessed by pressing  (**Menu**).
- Some menus may not appear on the display depending on options. If so, it is not applicable to your machine.
- For models that do not have the  (**Menu**) on the control panel, this feature is not applicable (see "Control panel overview" on page 18).

Print menu



Some menus may not appear in the display depending on options or models. If so, it is not applicable to your machine (see "Menu overview" on page 25).

To change the menu options:

- Press  (**Menu**) > **Print Setup** on the control panel.

Item	Description
Orientation	Selects the direction in which information is printed on a page.
Duplex	To print on both sides of the paper, choose the binding edge.
Copies	You can enter the number of copies using the number keypad.
Resolution	Specifies the number of dots printed per inch (dpi). The higher the setting, the sharper printed characters and graphics.
Darkness	Lightens or darkens the print on the page. The Normal setting usually produces the best result. Use the Light toner density setting to save toner.
Clear Text	Prints text darker than on a normal document.
Auto CR	Allows you to append the required carriage return to each line feed, which is useful for Unix or DOS users.

Item	Description
Emulation	Sets the emulation type and option.

Copy menu

Copy feature



Some menus may not appear in the display depending on options or models. If so, it is not applicable to your machine (see "Menu overview" on page 25).



To change the menu options:



- Press (copy) > (**Menu**) > **Copy Feature** on the control panel.

Item	Description
Scan Size	Sets the image size.
Copies	You can enter the number of copies using the number keypad.
Reduce/Enlarge	Reduces or enlarges the size of a copied image (see "Reduced or enlarged copy" on page 52). <div data-bbox="398 1161 452 1225" data-label="Image"> </div> If the machine is set Eco mode, reduce and enlarge features are not available.
Darkness	Adjusts the brightness level to make a copy that is easier to read, when the original contains faint markings and dark images (see "Darkness" on page 51)

Item	Description
Contrast	Adjusts the contrast level to scan an original that is easier to read, when the original contains too faint or too dark contents (see "Contrast" on page 52)
Original Type	Improves the copy quality by selecting the document type for the current copy job (see "Original" on page 52)
Layout	Adjusts the layout format such as poster, clone, ID copy, 2/4-up, booklet, etc.
Layout > 2-up or 4-up	Reduces the size of the original images and prints 2 or 4 pages onto one sheet of paper. <div data-bbox="1482 742 1751 922" data-label="Image"> </div> <div data-bbox="1496 992 1550 1056" data-label="Image"> </div> This copy feature is available only when you load originals into the document feeder.

Copy menu

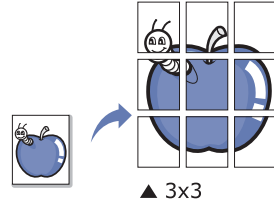
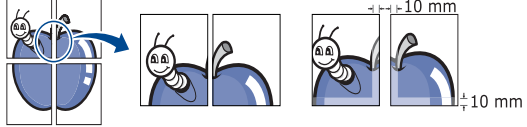
Item	Description
<p>Layout > ID copy</p>	<p>Your machine can print 2-sided originals on one sheet. The machine prints one side of the original on the upper half of the paper and the other side on the lower half without reducing the size of the original. This feature is helpful for copying a small-sized item such as business card.</p> <div data-bbox="383 576 1081 991" style="border: 1px solid #ccc; padding: 10px; background-color: #f9f9f9;">  <ul style="list-style-type: none"> The original must be placed on the scanner glass to use this feature. If the machine set to Eco mode, this feature is not available. For better image quality, Select  (copy) >  (Menu) > Copy Feature > Original Type > Photo on the control panel. </div>

Item	Description									
<p>Layout > Poster Copy</p>	<p>Prints a single-page document onto 4 (Poster 2x2), 9 (Poster 3x3), or 16 (Poster 4x4) sheets of paper, for the purpose of pasting the sheets together to form one poster-size document.</p> <div data-bbox="1491 475 2018 842">   </div> <div data-bbox="1491 879 2197 991" style="border: 1px solid #ccc; padding: 10px; background-color: #f9f9f9;">  <ul style="list-style-type: none"> This copy feature is available only when you place originals on the scanner glass. Your original is divided into 9 portions. Each portion is scanned and printed one by one in the following order: </div> <div data-bbox="1630 1150 1823 1385" style="margin: 10px 0;"> <table border="1" style="border-collapse: collapse; text-align: center; width: 80px; height: 80px;"> <tbody> <tr> <td>1</td> <td>2</td> <td>3</td> </tr> <tr> <td>4</td> <td>5</td> <td>6</td> </tr> <tr> <td>7</td> <td>8</td> <td>9</td> </tr> </tbody> </table> </div>	1	2	3	4	5	6	7	8	9
1	2	3								
4	5	6								
7	8	9								

Copy menu

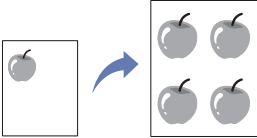
Item	Description
Layout > Clone Copy	<p>Prints multiple original images on a single page. The number of images is automatically determined by the original image and the paper size.</p>  <ul style="list-style-type: none">• This copy feature is available only when you place originals on the scanner glass.• You cannot adjust the copy size using Reduce/Enlarge for the Clone Copy feature.
Adjust Bkgd	<p>Prints an image without its background. This copy feature removes the background color and can be helpful when copying an original containing color in the background, such as a newspaper or a catalog.</p> <ul style="list-style-type: none">• Off: Does not use this feature.• Auto: Optimizes the background.• Enhance Lev. 1~2: The higher the number is, the more vivid the background is.• Erase Lev. 1~4: The higher the number is, the lighter the background is.

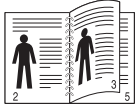
Item	Description
Duplex	<p>You can set the machine to print copies on both sides of paper.</p> <ul style="list-style-type: none">• Off: Prints in normal mode.• 1->2Side Short  <ul style="list-style-type: none">• 1->2Side Long 

Copy menu

Copy Setup



Some menus may not appear in the display depending on options or models. If so, it is not applicable to your machine (see "Menu overview" on page 25).

To change the menu options:

Press (copy) > (**Menu**) > **Copy Setup** on the control panel.

Item	Description
Change Default	Resets the value or setting to the printer's out-of-box state.

Fax menu

Fax Feature



Some menus may not appear in the display depending on options or models. If so, it is not applicable to your machine (see "Menu overview" on page 25).

To change the menu options:

- Press (fax) > **(Menu)** > **Fax Feature** on the control panel.

Item	Description
Darkness	Adjusts the brightness level to scan an original that is easier to read, when the original contains faint markings and dark images (see "Darkness" on page 51).
Contrast	Adjusts the contrast level to scan an original that is easier to read, when the original contains too faint or too dark contents.
Resolution	The default document settings procedure good results when using typical text-based originals. However, if you send originals that are of poor quality, or contain photographs, you can adjust the resolution to produce a higher quality fax (see "Resolution" on page 58).
Scan Size	Sets the image size.

Item	Description
Multi Send	<p>Sends a fax to multiple destinations (see "Sending a fax to multiple destinations" on page 57).</p> <p> You cannot send a color fax using this feature.</p>
Delay Send	<p>Sets your machine to send a fax at a later time when you will not be present (see "Delaying a fax transmission" on page 176).</p> <p> You cannot send a color fax using this feature.</p>
Priority Send	<p>Scans the original into memory and immediately transmits it when the current operation is finished. Priority transmission will interrupt a sending to multiple destinations between stations (example, when the transmission to station A ends, before transmission to station B begins) or between redial attempts (see "Sending a priority fax" on page 177).</p>
Forward	<p>Forwards the received or sent fax to other destination by a fax or PC. If you are out of office but have to receive the fax, this feature may be useful.</p> <ul style="list-style-type: none">• See "Forwarding a sent fax to another destination" on page 177.• See "Forwarding a received fax" on page 178.

Fax menu

Item	Description
Secure Receive	Stores the received fax in memory without printing out. To print received documents, you need to enter the password. You can prevent your received faxes from being accessed by unauthorized people (see "Receiving in secure receiving mode" on page 181).
Add Page	Adds additional documents to a reserved delay fax job (see "Adding documents to a reserved fax" on page 176).
Cancel Job	Cancels the delayed fax job which is saved in memory (see "Canceling a reserved fax job" on page 177).

Sending setup



Some menus may not appear in the display depending on options or models. If so, it is not applicable to your machine (see "Menu overview" on page 25).

To change the menu options:

- Press  (fax) >  (**Menu**) > **Fax Setup** > **Sending** on the control panel.

Item	Description
Redial Times	Sets the number of redial attempts. If you enter 0, the machine will not redial.
Redial Term	Sets the time interval before automatic redialling.
Prefix Dial	Sets a prefix of up to five digits. This number dials before any automatic dial number is started. It is useful for accessing a PABX exchange.
ECM Mode	Sends faxes using error correction mode (ECM) to make sure the faxes are sent smoothly without any error. It may take more time.
Send Report	Sets the machine to print a report whether a fax transmission was successfully completed or not. If you select On-Error , the machine prints a report only when a transmission is not successful.
Image TCR	Prints a transmission report with a minimized image of the first page of the fax sent.
Dial Mode	Sets the dialing mode to either tone or pulse. This setting may not be available depending on your country.

Fax menu

Receiving setup



Some menus may not appear in the display depending on options or models. If so, it is not applicable to your machine (see "Menu overview" on page 25).

To change the menu options:

- Press  (fax) >  (**Menu**) > **Fax Setup** > **Receiving** on the control panel.

Item	Description
Receive Mode	Selects the default fax receiving mode.
Ring To Answer	Specifies the number of times the machine rings before answering an incoming call.
Stamp RCV Name	Automatically prints the page number, and the date and time of reception at the bottom of each page of a received fax.
Rcv Start Code	Initiates fax reception from an extension phone plugged into the EXT socket on the back of the machine. If you pick up the extension phone and hear fax tones, enter the code. It is preset to *9* at the factory.

Item	Description
Auto Reduction	Automatically reduces an incoming fax page to fit the size of the paper loaded in the machine.
Discard Size	Discards a specific length from the end of the received fax.
Junk Fax Setup	Blocks any unwanted faxes that you stored in the memory as junk fax numbers. This setting may not be available depending on your country.
DRPD Mode	Enables a user to use a single telephone line to answer several different telephone numbers. You can set the machine to recognize different ring patterns for each number. This setting may not be available depending on your country (see "Receiving faxes using DRPD mode" on page 181).
Duplex Print	Prints the received fax data on both sides of the paper. You can save the paper usage.

System setup

Machine setup



Some menus may not appear in the display depending on options or models. If so, it is not applicable to your machine (see "Menu overview" on page 25).

To change the menu options:

- Press  **(Menu)** > **System Setup** > **Machine Setup** on the control panel.

Item	Description
Machine ID	Sets the machine ID which will be printed at the top of each fax page that you send.
Fax Number	Sets the fax number which will be printed at the top of each fax page that you send.
Date & Time	Sets the date and time.
Clock Mode	Selects the format for displaying time between 12 hr. and 24 hr.
Language	Sets the language of the text that appears on the control panel display.

Item	Description
PowerSave	Sets how long the machine waits before going to power save mode. When the machine does not receive data for an extended period of time, power consumption is automatically lowered.
Wakeup Event	You can set the condition to wake up from power-save mode. Set the item on. <ul style="list-style-type: none">Button Press: When you press any button except power button, the machine wake up from the power save mode.Scanner: When you insert paper in the document feeder, the machine wake up from the power save mode.Printer: When you open or close the scan unit, the machine wake up from the power save mode.
System Timeout	Sets the time that the machine remembers previously used copy settings. After the timeout, the machine restores the default copy settings.
Job Timeout	Sets the length of time the printer waits before printing the last page of a print job that does not end with a command to print the page.
Altitude Adj.	Optimize print quality according to the machine's altitude.

System setup

Item	Description
Auto Continue	<p>Determine whether or not the machine continues printing when it detects the paper does not match the paper settings.</p> <ul style="list-style-type: none">• Off: If a paper mismatch occurs, the machine waits until you insert the correct paper.• On: If a paper mismatch occurs, an error message will display. The machine waits for about 30 second, then automatically clear the message and continue printing.
Paper Mismatch	<p>Determine whether to disregard the paper mismatch error or not. Select Off, then the machine does not stop printing even if the paper mismatches.</p>
Paper Substit	<p>Automatically substitutes the printer driver's paper size to prevent the paper mismatch between Letter and A4. For example, if you have A4 paper in the tray but you set the paper size to Letter in the printer driver, the machine prints on A4 paper and vice versa.</p>
PrintBlankPage	<p>The printer detects the printing data from computer whether a page is empty or not. You can set to print or skip the blank page.</p>
Toner Save	<p>Activating this mode extends the life of your toner cartridge and reduces your cost per page beyond what one would experience in the normal mode, but it reduces print quality.</p>

Item	Description
Eco Settings	<p>Allows you to save print resources and enables eco-friendly printing.</p> <ul style="list-style-type: none">• Default Mode: Select whether to turn the Eco mode on or off. <div style="border: 1px solid #ccc; padding: 5px;"><p> On force (On-Forced): Sets the Eco mode on with password. If a user wants to turn the Eco mode on/off, the user needs to enter the password.</p></div> <ul style="list-style-type: none">• Select Template (Select Temp.): Selects the eco template set from the Embedded Web Service.

Paper setup



Some menus may not appear in the display depending on options or models. If so, it is not applicable to your machine (see "Menu overview" on page 25).

System setup

To change the menu options:

- Press  (**Menu**) > **System Setup** > **Paper Setup** on the control panel.

Item	Description
Paper Size	Sets the paper size as A4, Letter, or other paper sizes, according to your requirements.
Paper Type	Chooses the type of the paper for each tray.
Paper Source	Selects from which tray the paper is used.
Margin	Sets the margins for the document.



Sound / Volume



Some menus may not appear in the display depending on options or models. If so, it is not applicable to your machine (see "Menu overview" on page 25).

To change the menu options:

- Press  (**Menu**) > **System Setup** > **Sound/Volume** on the control panel.

Item	Description
Key Sound	Turns the key sound on or off. With this option set to on, a tone sounds each time a key is pressed.
Alarm Sound	Turns the alarm sound on or off. With this option set to on, an alarm tone sounds when an error occurs or fax communication ends.
Speaker	<p>Turns on or off the sounds from the telephone line through the speaker, such as a dial tone or a fax tone. With this option set to Comm. which means the speaker is on until the remote machine answers.</p> <div data-bbox="1464 906 2192 1430"><p> You can adjust the volume level using On Hook Dial. You can adjust the speaker volume only when the telephone line is connected.</p><ol style="list-style-type: none">Press  (fax) on the control panel.Press On Hook Dial. A dial tone sounds from the speaker.Press the arrows until you hear the volume you want.Press On Hook Dial to save the change and return to ready mode.</div>

System setup

Item	Description
Ringer	Adjusts the ringer volume. For the ringer volume, you can select off, low, middle, and high level.

Report



Some menus may not appear in the display depending on options or models. If so, it is not applicable to your machine (see "Menu overview" on page 25).

To change the menu options:

- Press  **(Menu)** > **System Setup** > **Report** on the control panel.

Item	Description
All Reports	Prints all kinds of reports that this machine provides.
Configuration	Prints a report on the machine's overall configuration.
Supplies Info.	Prints supplies' information page.
Address Book	Prints all of the email addresses currently stored in the machine's memory.

Item	Description
Fax Send	Prints a transmission report including the fax number, the number of pages, the elapsed time of the job, the communication mode, and the communication results for fax job. You can set up your machine to automatically print a transmission confirmation report after each fax job.
Fax Sent	Prints information on the faxes you have recently sent.
Fax Received	Prints information on the faxes you have recently received.
Scheduled Jobs	Prints the document list currently stored for delayed faxes along with the starting time and type of each operation.
JunkFax	Prints the fax numbers specified as junk fax numbers.
Network Conf.	Prints information on your machine's network connection and configuration.
Usage Counter	Prints a usage page. The usage page contains the total number of pages printed.
Fax Options	Prints the information of a fax reports.

System setup

Maintenance



Some menus may not appear in the display depending on options or models. If so, it is not applicable to your machine (see "Menu overview" on page 25).

To change the menu options:

- Press  **(Menu)** > **System Setup** > **Maintenance** on the control panel.

Item	Description
CLR Empty Msg.	When toner cartridge is empty, this option appears. You can clear the empty message.
Supplies Life	Shows the supply life indicators (see "Monitoring the supplies life" on page 67.)
Serial No.	Shows the machine's serial number. When you call for service or register as a user on the Dell website, you can find this.
TonerLow Alert	Customizes the level to alert toner low or toner empty (see "Setting the toner low alert" on page 68).

Clear setting



Some menus may not appear in the display depending on options or models. If so, it is not applicable to your machine (see "Menu overview" on page 25).

To change the menu options:

- Press  **(Menu)** > **System Setup** > **Clear Setting** on the control panel.

Item	Description
All Setting	Clears all of the data stored in memory and resets all of your settings to the factory default.
Printer Setup	Restores all of the printer options to the factory default.
Fax Setup	Restores all of the fax options to the factory default.
Copy Setup	Restores all of the copy options to the factory default.
System Setup	Restores all of the system options to the factory default.
Network Setup	Restores all of the network options to the factory default. (Reboot required.)

System setup

Item	Description
Address Book	Clears all of the email address entries stored in memory.
Fax Sent	Clears all records of sent faxes.
Email Sent	Clears all records of sent emails.
Fax Received	Clears all records of received faxes.

Network setup



Some menus may not appear in the display depending on options or models. If so, it is not applicable to your machine (see "Menu overview" on page 25).

- Press **(Menu)**> **Network** on the control panel,

Option	Description
TCP/IP (IPv4)	Selects the appropriate protocol and configure parameters to use the network environment. There are lots of parameters to be set. If you are not sure, leave as is, or consult the network administrator.
TCP/IP (IPv6)	Selects this option to use the network environment through IPv6 (see "IPv6 configuration" on page 126).
Ethernet Speed	Configure the network transmission speed.
Clear Setting	Reverts the network settings to the default values. (Reboot required.)
Network Conf.	This list shows information on your machine's network connection and configuration.



4. Special Features

This chapter explains special copying, scanning, faxing, and printing features.

- **Altitude adjustment** 150
- **Entering various characters** 151
- **Setting up the fax address book** 152
- **Printing features** 155
- **Scan features** 167
- **Fax features** 174



- The procedures in this chapter are mainly based on Windows 7.
- It may be necessary to press **OK** to navigate to lower-level menus for some models.

Altitude adjustment

Print quality is affected by atmospheric pressure, which is determined by the height of the machine above sea level. The following information will guide you on how to set your machine for the best print quality.

Before you set the altitude value, determine the altitude where you are.

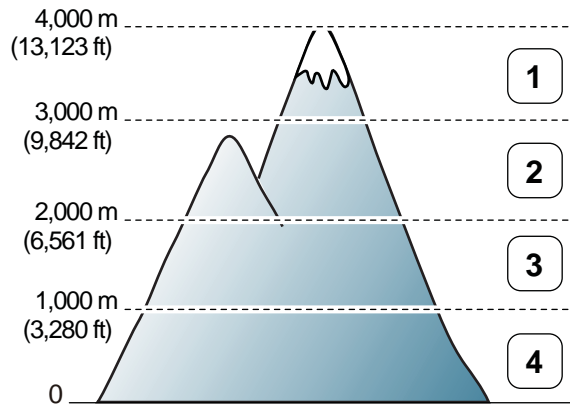

- 1 High 3
- 2 High 2
- 3 High 1
- 4 Normal

- For Windows and Macintosh users, see "Device Settings" on page 190.

You can set the altitude value from **Device Settings** in Dell Printer Manager program or **Machine** section in Printer Settings Utility program.



If your machine is connected to the network, you can set the altitude via Embedded Web Service (see "Using Embedded Web Service" on page 186).

Entering various characters

As you perform various tasks, you may need to enter names and numbers. For example, when you set up your machine, you enter your name or your company's name, and the fax number. When you store fax numbers or email addresses in memory, you may also enter the corresponding names.

Entering alphanumeric characters

Press the button until the correct letter appears on the display. For example, to enter the letter O, press 6, labeled with MNO. Each time you press 6, the display shows a different letter, M, N, O, m, n, o and finally 6. To find the letter that you want to enter, see "Keypad letters and numbers" on page 151.



- You can enter a space by pressing 1 twice.
- To delete the last digit or character, press the left/right or up/down arrow button.

Keypad letters and numbers





- Special character sets may differ from your machine depending on its options.
- Some of the follow key values may not appear depending on the job you are doing.



Key	Assigned numbers, letters, or characters
1	@ / . ' 1
2	A B C a b c 2
3	D E F d e f 3
4	G H I g h i 4
5	J K L j k l 5
6	M N O m n o 6
7	P Q R S p q r s 7
8	T U V t u v 8
9	W X Y Z w x y z 9
0	& + - , 0
*	* % ^ _ ~ ! # \$ () [] (These symbols are available when you type for network authentication.)
#	# = ? " : { } < > ; (These symbols are available when you type for network authentication.)

Setting up the fax address book

You can set up speed number with the fax numbers you use frequently via Embedded Web Service and then easily and quickly enter fax numbers by entering the location numbers assigned to them in address book.

Registering a speed dial number

- 1 Select  (fax) >  (**Address Book**) > **New & Edit** > **Speed Dial** on the control panel.
- 2 Enter a speed dial number and press **OK**.



 If an entry is already stored in the number you choose, the display shows the message to allow you to change it. To start over with another speed dial number, press  (**Back**).

- 3 Enter the name you want and press **OK**.
- 4 Enter the fax number you want and press **OK**.
- 5 Press the  (**Stop/Clear**) button to return to ready mode.



Using speed dial numbers

When you are prompted to enter a destination number while sending a fax, enter the speed dial number at which you stored the number you want.



- For a one-digit (0-9) speed dial number, press and hold the corresponding digit button on the number keypad for more than 2 seconds.
- For a two- or three-digit speed dial number, press the first digit button(s) and then hold down the last digit button for more than 2 seconds.
- You can print the address book list by selecting  (fax) >  (**Address Book**) > **Print**.

Editing speed dial numbers

- 1 Select  (fax) >  (**Address Book**) > **New & Edit** > **Speed Dial** on the control panel.
- 2 Enter the speed dial number you want to edit and press **OK**.
- 3 Change the name and press **OK**.
- 4 Change the fax number and press **OK**.



Setting up the fax address book

- 5 Press  (**Stop/Clear**) to return to ready mode.

Registering a group dial number



- 1 Select  (fax) >  (**Address Book**) > **New & Edit** > **Group Dial** on the control panel.

- 2 Enter a group dial number and press **OK**.

 If an entry is already stored in the number you choose, the display shows the message to allow you to change it. To start over with another speed dial number, press  (**Back**).

- 3 Search by entering the first few letters of the speed dial's name to put in the group.
- 4 Select the name and number you want and press **OK**.
- 5 Select **Yes** when **Another Number?** appears.
- 6 Repeat step 3 to include other speed dial numbers into the group.
- 7 When you have finished, select **No** when **Another Number?** appears and press **OK**.
- 8 Press  (**Stop/Clear**) to return to ready mode.



Editing group dial numbers

- 1 Select  (fax) >  (**Address Book**) > **New & Edit** > **Group Dial** on the control panel.
- 2 Enter the group dial number you want to edit and press **OK**.
- 3 Enter a new speed dial number to add and press **OK**, then **Add?** appears. Enter a speed dial number stored in the group and press **OK**, **Delete?** appears.
- 4 Press **OK** to add or delete the number.
- 5 Repeat step 3 to add or delete more numbers.
- 6 Select **No** at the **Another Number?** and press **OK**.
- 7 Press  (**Stop/Clear**) to return to ready mode.

Searching address book for an entry

There are two ways to search for a number in memory. You can either scan from A to Z sequentially, or you can search by entering the first letters of the name associated with the number.



Setting up the fax address book

- 1 Select **ct**  (fax) >  (**Address Book**) > **Search&Dial** > **Speed Dial** or **Group Dial** on the control panel.
- 2 Enter **All** or **ID** and press **OK**.
- 3 Press the name and number or the keypad button labeled with the letter you want to search.

For example, if you want to find the name "MOBILE," press the **6** button, which is labeled with "MNO."
- 4 Press  (**Stop/Clear**) to return to ready mode.

Printing address book

You can check your  (**Address Book**) settings by printing a list.

- 1 Select **ct**  (fax) >  (**Address Book**) > **Print** on the control panel.
- 2 The machine begins printing.

Printing features



For basic printing features, refer to the Basic Guide (see "Basic printing" on page 45).

Changing the default print settings

- 1 Click the Windows **Start** menu.
- 2 Select **Control Panel > Devices and Printers**.
- 3 Right-click on your machine.
- 4 Select **Printing preferences**.



If **Printing preferences** has a ►, you can select other printer drivers connected to the selected printer.

- 5 Change the settings on each tab.
- 6 Click **OK**.



If you want to change the settings for each print job, change it in **Printing Preferences**.

Setting your machine as a default machine

- 1 Click the Windows **Start** menu.
- 2 Select **Control Panel > Devices and Printers**.
- 3 Select your machine.
- 4 Right-click your machine and select **Set as Default Printer**.



If **Printing preferences** has a ►, you can select other printer drivers connected to the selected printer.

Using advanced print features



XPS printer driver: used to print XPS file format.

- The XPS printer driver can be installed only on Windows Vista OS or higher.
- You can install the XPS printer driver when you insert the software CD into your CD-ROM drive. When you install the Dell software, the XPS printer driver is automatically installed.

Printing features

Printing to a file (PRN)

You will sometimes need to save the print data as a file.

- 1 Check the **Print to file** box in the **Print** window.

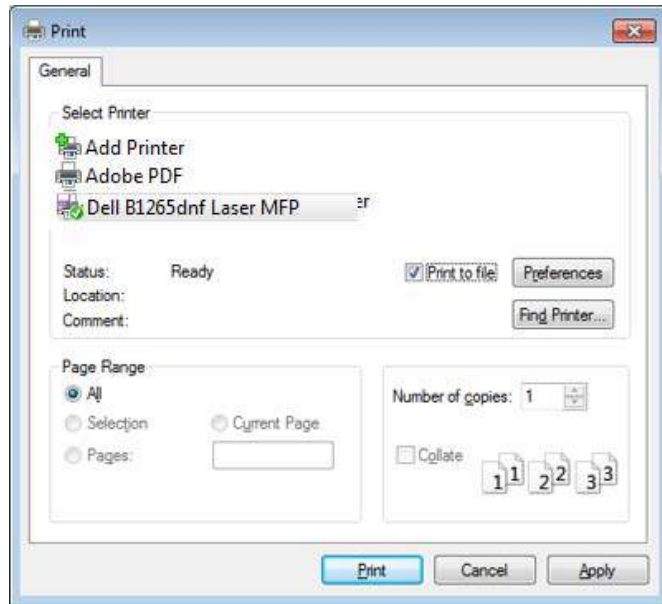

- 2 Click **Print**.
- 3 Type in the destination path and the file name, and then click **OK**.
For example, **c:\Temp\file name**.



If you type in only the file name, the file is automatically saved in **My Documents**, **Documents and Settings**, or **Users**. The saved folder may differ, depending on your operating system or the application you are using.

Understanding special printer features

You can use advanced printing features when using your machine.





To take advantage of the printer features provided by your printer driver, click **Properties** or **Preferences** in the application's **Print** window to change the print settings. The machine name, that appears in the printer properties window may differ depending on the machine in use.

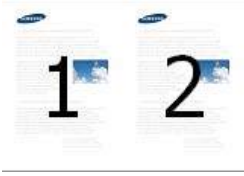
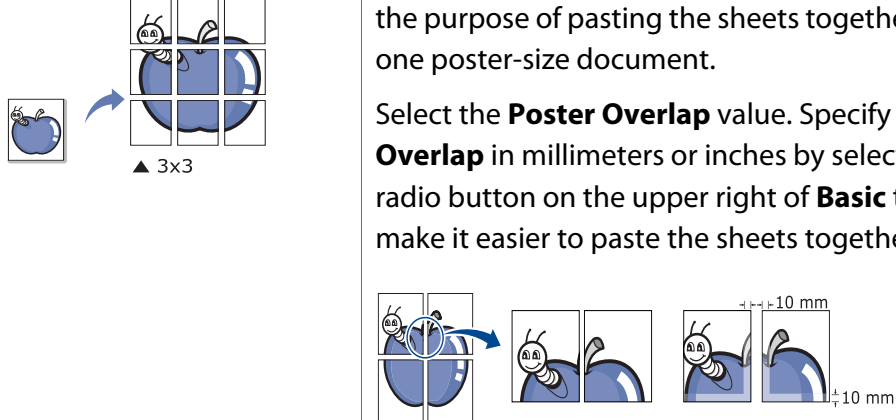

- Some menus may not appear on the display depending on options or models. If so, it is not applicable to your machine.
- Select the **Help** or click the  button from the window or press **F1** on your keyboard and click on any option you want to know about (see "Using help" on page 48).

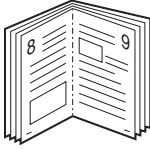
Printing features

Item	Description
<p data-bbox="49 288 383 323">Multiple Pages per Side</p> 	<p data-bbox="427 288 1079 491">Selects the number of pages to print on a single sheet of paper. To print more than one page per sheet, the pages will be reduced in size and arranged in the order you specify. You can print up to 16 pages on one sheet.</p>
<p data-bbox="49 571 259 606">Poster Printing</p> 	<p data-bbox="427 571 1079 730">Prints a single-page document onto 4 (Poster 2x2), 9 (Poster 3x3), or 16 (Poster 4x4) sheets of paper, for the purpose of pasting the sheets together to form one poster-size document.</p> <p data-bbox="427 751 1079 906">Select the Poster Overlap value. Specify Poster Overlap in millimeters or inches by selecting the radio button on the upper right of Basic tab to make it easier to paste the sheets together.</p>

Item	Description
<p data-bbox="1160 277 1406 312">Booklet Printing^a</p> 	<p data-bbox="1541 272 2199 389">Prints your document on both sides of a sheet of paper and arranges the pages so that the paper can be folded in half after printing to produce a booklet.</p> <p data-bbox="1541 410 2199 523">If you want to make a booklet, you need to print on Letter, Legal, A4, US Folio, or Oficio sized print media.</p> <div data-bbox="1547 576 2190 1050" style="border: 1px solid #ccc; padding: 10px; margin-top: 10px;"> <p data-bbox="1561 608 2132 810">  The Booklet Printing option is not available for all paper sizes. Select the available paper Size option under the Paper tab to see what paper sizes are available. </p> <p data-bbox="1637 836 2190 1002"> If you select an unavailable paper size, this option can be automatically canceled. Select only available paper (paper without  or  mark). </p> </div>

Printing features

Item	Description
<p>Double-sided Printing</p>	<p>Print on both sides of a sheet of paper (manual). Before printing, decide how you want your document oriented.</p> <div data-bbox="427 438 1079 999" style="border: 1px solid #ccc; padding: 10px; margin-top: 10px;">  <ul style="list-style-type: none"> • You can use this feature with Letter, Legal, A4, US Folio or Oficio sized paper • If your machine does not have a duplex unit, you should complete the printing job manually. The machine prints every other page of the document first. After that, a message appears on your computer. • We recommend not to print on both sides of the special media, such as labels, envelopes, or thick paper. It may cause a paper jam or damage the machine. </div>

Item	Description
<p>Double-sided Printing</p>	<ul style="list-style-type: none"> • None: Disables this feature. • Long Edge: This option is the conventional layout used in bookbinding. <div data-bbox="1576 432 1794 539" style="text-align: center;"> </div> <ul style="list-style-type: none"> • Short Edge: This option is the conventional layout used in calendars. <div data-bbox="1576 663 1794 799" style="text-align: center;"> </div> <ul style="list-style-type: none"> • Reverse Double-Sided Printing: Check this option to reverse the print order when duplex printing.
<p>Paper Options</p>	<p>Changes the size of a document to appear larger or smaller on the printed page by entering in a percentage by which to enlarge or decrease the document.</p>
<p>Watermark</p>	<p>The watermark option allows you to print text over an existing document. For example, you use it when you want to have large gray letters reading “DRAFT” or “CONFIDENTIAL” printed diagonally across the first page or all pages of a document.</p>

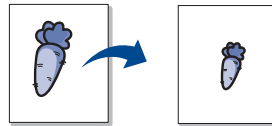



Printing features

Item	Description
Watermark (Creating a watermark)	<p>a To change the print settings from your software application, access Printing Preferences.</p> <p>b Click the Advanced tab, select Edit from the Watermark drop-down list. The Edit Watermarks window appears.</p> <p>c Enter a text message in the Watermark Message box. You can enter up to 256 characters. The message displays in the preview window.</p>
Watermark (Editing a watermark)	<p>a To change the print settings from your software application, access Printing Preferences.</p> <p>b Click the Advanced tab, select Edit from the Watermark drop-down list. The Edit Watermarks window appears.</p> <p>c Select the watermark you want to edit from the Current Watermarks list and change the watermark message and options.</p> <p>d Click Update to save the changes.</p> <p>e Click OK or Print until you exit the Print window.</p>

Item	Description
Watermark (Deleting a watermark)	<p>a To change the print settings from your software application, access Printing Preferences.</p> <p>b Click the Advanced tab, select Edit from the Watermark drop-down list. The Edit Watermarks window appears.</p> <p>c Select the watermark you want to delete from the Current Watermarks list and click Delete.</p> <p>d Click OK or Print until you exit the Print window.</p>

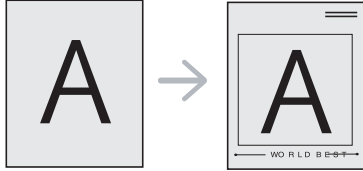
Printing features

Item	Description
<p data-bbox="53 277 174 309">Overlay^a</p> 	<p data-bbox="427 272 1084 344">This option is available only when you use the SPL/ PCL printer driver.</p> <p data-bbox="427 368 1084 483">An overlay is text and/or images stored in the computer hard disk drive (HDD) as a special file format that can be printed on any document. Overlays are often used to take the place of letterhead paper. Rather than using preprinted letterhead, you can create an overlay containing exactly the same information that is currently on your letterhead. To print a letter with your company's letterhead, you do not need to load preprinted letterhead paper in the machine: just print the letterhead overlay on your document.</p> <p data-bbox="427 839 1084 911">To use a page overlay, you must create a new page overlay containing your logo or image.</p> <div data-bbox="427 963 1084 1361"><ul data-bbox="524 995 1084 1310" style="list-style-type: none"><li data-bbox="524 995 1084 1142">• The overlay document size must be the same as the document you print with the overlay. Do not create an overlay with a watermark.<li data-bbox="524 1166 1084 1310">• The resolution of the overlay document must be the same as that of the document you will print with the overlay.</div>

Item	Description
<p data-bbox="1160 272 1512 400">Overlay (Creating a new page overlay)</p>	<ol data-bbox="1538 272 2204 919" style="list-style-type: none"><li data-bbox="1538 272 2204 344">a To save the document as an overlay, access Printing Preferences.<li data-bbox="1538 352 2204 467">b Click the Advanced tab, and select Edit from the Text drop-down list. Edit Overlay window appears.<li data-bbox="1538 475 2204 515">c In the Edit Overlay window, click Create.<li data-bbox="1538 523 2204 675">d In the Save As window, type a name up to eight characters in the File name box. Select the destination path, if necessary (The default is C:\Formover).<li data-bbox="1538 683 2204 754">e Click Save. The name appears on the Overlay List.<li data-bbox="1538 762 2204 919">f Click OK or Print until you exit the Print window. The file is not printed. Instead, it is stored on your computer hard disk drive.

Printing features

Item	Description
Overlay (Using a page overlay)	<p>a Click the Advanced tab.</p> <p>b Select the desired overlay from the Text drop-down list.</p> <p>c If the overlay file you want does not appear in the Text drop-down list, select Edit... from the list and click Load. Select the overlay file you want to use.</p> <p>If you have stored the overlay file you want to use in an external source, you can also load the file when you access the Open window.</p> <p>After you select the file, click Open. The file appears in the Overlay List box and is available for printing. Select the overlay from the Overlay List box.</p> <p>d If necessary, check Confirm Page Overlay When Printing box. If this box is checked, a message window appears each time you submit a document for printing, asking you to confirm printing an overlay on your document.</p> <p>If this box is not checked and an overlay has been selected, the overlay automatically prints with your document.</p> <p>e Click OK or Print until you exit the Print window.</p>

Item	Description
Overlay (Deleting a page overlay)	<p>a In the Printing Preferences window, click the Advanced tab.</p> <p>b Select Edit in the Text drop down list.</p> <p>c Select the overlay you want to delete from the Overlay List box.</p> <p>d Click Delete.</p> <p>e When a confirming message window appears, click Yes.</p> <p>f Click OK or Print until you exit the Print window. You can delete page overlays that you no longer use.</p>

a. This option is not available when you use XPS driver.

Macintosh printing



Some features may not be available depending on models or options. It means that the features are not supported.

Printing a document

When you print with a Macintosh, you need to check the printer driver settings in each application you use. Follow the steps below to print from a Macintosh:

Printing features

- 1 Open the document to print.
- 2 Open the **File** menu and click **Page Setup** (**Document Setup** in some applications).
- 3 Choose your paper size, orientation, scaling, other options, and make sure that your machine is selected. Click **OK**.
- 4 Open the **File** menu and click **Print**.
- 5 Choose the number of copies and indicate which pages to print.
- 6 Click **Print**.

Changing printer settings

You can use advanced printing features when using your machine.

Open an application and select **Print** from the **File** menu. The machine name, which appears in the printer properties window, may differ depending on the machine in use. Except for the name, the composition of the printer properties window is similar to the following.

Printing multiple pages on one sheet

You can print more than one page on a single sheet of paper. This feature provides a cost-effective way to print draft copies.

- 1 Open an application, and select **Print** from the **File** menu.
- 2 Select **Layout** from the drop-down list under **Orientation**. In the **Pages per Sheet** drop-down list, select the number of pages you want to print on one sheet of paper.
- 3 Select the other options to use.
- 4 Click **Print**.
The machine prints the selected number of pages to print on one sheet of paper.

Using help

Click the question mark on the bottom-left corner of the window and click on the topic you want to know about. A pop-up window appears with information about that option's feature, which is provided from the driver.

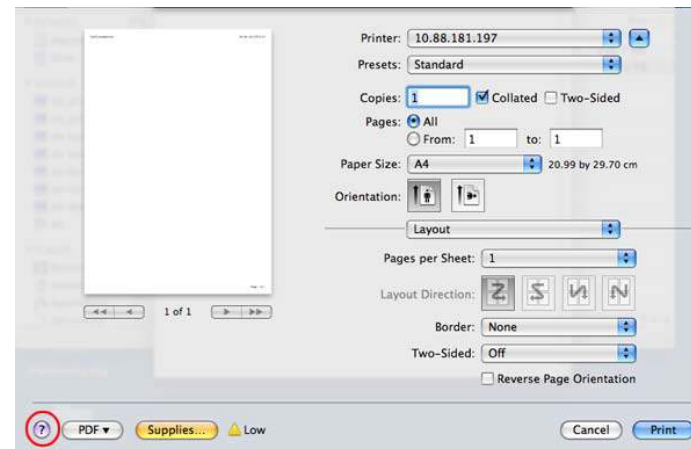

Printing features

Linux printing



Some features may not be available depending on models or options. It means that the features are not supported.

Printing from applications

There are a lot of Linux applications that allow you to print using Common UNIX Printing System (CUPS). You can print on your machine from any such application.

- 1 Open an application, and select **Print** from the **File** menu
- 2 Select **Print** directly using `lpr`.
- 3 In the LPR GUI window, select the model name of your machine from the printer list and click **Properties**.

- 4 Change the print job properties using the following four tabs displayed at the top of the window.

- **General:** Changes the paper size, the paper type, and the orientation of the documents. It enables the duplex feature, adds start and end banners, and changes the number of pages per sheet.



Automatic/manual duplex printing may not be available depending on models. You can alternatively use the `lpr` printing system or other applications for odd-even printing.

- **Text:** Specifies the page margins and set the text options, such as spacing or columns.
- **Graphics:** Sets image options that are used when printing image files, such as color options, image size, or image position.
- **Advanced:** Sets the print resolution, paper source, and destination.

- 5 Click **Apply** to apply the changes and close the **Properties** window.

- 6 Click **OK** in the **LPR GUI** window to start printing.

- 7 The Printing window appears, allowing you to monitor the status of your print job.

To abort the current job, click **Cancel**.

Printing features

Printing files

You can print many different types of files on your machine using the standard CUPS, directly from the command line interface. The CUPS lpr utility allows you to do that, but the driver's package replaces the standard lpr tool by a much more user-friendly LPR GUI program.

To print any document file:

- 1 Enter `lpr <file_name>` from the Linux shell command line and press Enter. The **LPR GUI** window appears.

When you type only `lpr` and press **Enter**, the **Select file(s) to print** window appears first. Just select any files you want to print and click **Open**.

- 2 In the **LPR GUI** window, select your machine from the list, and change the print job properties.
- 3 Click **OK** to start printing.

Configuring Printer Properties

Using the **Printer Properties** window provided by the **Printers configuration**, you can change the various properties for your machine as a printer.

- 1 Open the **Unified Driver Configurator**.
If necessary, switch to **Printers configuration**.
- 2 Select your machine on the available printers list and click **Properties**.
- 3 The **Printer Properties** window appears.
The following five tabs display at the top of the window:
 - **General:** Allows you to change the printer location and name. The name entered in this tab displays on the printer list in **Printers configuration**.
 - **Connection:** Allows you to view or select another port. If you change the machine port from USB to parallel or vice versa while in use, you must re-configure the machine port in this tab.
 - **Driver:** Allows you to view or select another machine driver. By clicking **Options**, you can set the default device options.
 - **Jobs:** Shows the list of print jobs. Click **Cancel job** to cancel the selected job and select the **Show completed jobs** check box to see previous jobs on the job list.
 - **Classes:** Shows the class that your machine is in. Click **Add to Class** to add your machine to a specific class or click **Remove from Class** to remove the machine from the selected class.
- 4 Click **OK** to apply the changes and close the **Printer Properties** window.

Printing features

Unix printing



Some features may not be available depending on models or options. It means that the features are not supported (see "Features" on page 6).

Proceeding the print job

After installing the printer, choose any of the image, text, PS files to print.

- 1 Execute "**printui <file_name_to_print>**" command.
For example, if you are printing "**document1**"
printui document1
This will open the UNIX Printer Driver **Print Job Manager** in which the user can select various print options.
- 2 Select a printer that has been already added.
- 3 Select the printing options from the window such as **Page Selection**.
- 4 Select how many copies are needed in **Number of Copies**.



To take advantage of the printer features provided by your printer driver, press **Properties**.

- 5 Press **OK** to start the print job.

Changing the machine settings

The UNIX printer driver **Print Job Manager** in which the user can select various print options in printer **Properties**.

The following hot keys may also be used: "H" for **Help**, "O" for **OK**, "A" for **Apply**, and "C" for **Cancel**.

General tab

- **Paper Size:** Set the paper size as A4, Letter, or other paper sizes, according to your requirements.
- **Paper Type:** Choose the type of the paper. Options available in the list box are **Printer Default**, **Plain**, and **Thick**.
- **Paper Source:** Select from which tray the paper is used. By default, it is **Auto Selection**.
- **Orientation:** Select the direction in which information is printed on a page.
- **Duplex:** Print on both sides of paper to save paper.

Printing features



Automatic/manual duplex printing may not be available depending on models. You can alternatively use the lpr printing system or other applications for odd-even printing.

- **Multiple pages:** Print several pages on one side of the paper.
- **Page Border:** Choose any of the border styles (e.g., **Single-line hairline**, **Double-line hairline**)

Image tab

In this tab, you can change the brightness, resolution, or image position of your document.

Text tab

Set the character margin, line space, or the columns of the actual print output.

Margins tab

- **Use Margins:** Set the margins for the document. By default, margins are not enabled. The user can change the margin settings by changing the values in the respective fields. Set by default, these values depend on the page size selected.
- **Unit:** Change the units to points, inches, or centimeters.

Printer-Specific Settings tab

Select various options in the **JCL** and **General** frames to customize various settings. These options are specific to the printer and depend on the PPD file.

Scan features



- For basic scanning features, refer to the Basic Guide (see "Basic scanning" on page 55).
- This feature may not be available depending on model or optional goods (see "Features" on page 6).
- The maximum resolution that can be achieved depends upon various factors, including computer speed, available disk space, memory, the size of the image being scanned, and bit depth settings. Thus, depending on your system and what you are scanning, you may not be able to scan at certain resolutions, especially using enhanced dpi.

Basic scanning method

You can scan the originals with your machine via an USB cable or the network. The following methodologies can be used for scanning your documents:

- **Scan to PC:** Scan the originals from the control panel. Then, the scanned data will be stored in the connected computers **My Documents** folder (see "Basic Scanning" on page 55).
- **TWAIN:** TWAIN is the one of a preset imaging applications. Scanning an image launches the selected application, enabling you to control the scanning process. This feature can be used via the local connection or the network connection (see "Scanning from image editing program" on page 168).

- **Dell Scan Assistant/SmarThru Office:** You can use this program to scan images or documents.
 - See "Scanning with Dell Scan Assistant" on page 169
 - See "Scanning with SmarThru Office" on page 170
- **WIA:** WIA stands for Windows Images Acquisition. To use this feature, your computer must be connected directly with the machine via an USB cable (see "Scanning using the WIA driver" on page 169).

Setting the scan settings in the computer

- 1 Open **Dell Printer Manager** (see "Using Dell Printer Manager" on page 188).
- 2 Select the appropriate machine from the **Printer List**.
- 3 Select **Scan to PC Settings** menu.
- 4 Select the option you want.
 - **Scan Activation:** Determines whether or not scanning is enabled on the device.
 - **Profile:** Displays the scanning profiles saved on the selected device.
 - **Basic tab:** Contains settings related to general scan and device settings.
 - **Image tab:** Contains settings related to image altering.

Scan features

5 Press **OK**.

Scanning from network connected machine

Make sure the printer driver is installed on your computer using the software CD, since the printer driver includes the scan program (see "Installing the driver locally" on page 21).

1 Place a single document face down on the document glass, or load the documents face up into the document feeder (see "Loading originals" on page 42).

2 Select  (**Scan**) > **Scan to PC** > **Network PC** on the control panel.

 If you see **Not Available** message, check the port connection.

3 Select your registered computer **ID**, and enter the **Password** if necessary.



• **ID** is the same ID as the registered scan ID for **Dell Printer Manager** >



Switch to advanced mode > **Scan to PC Settings**.

• **Password** is the 4 digit number registered password for **Dell Printer**



Manager > Switch to advanced mode > **Scan to PC Settings**.

4 Select the option you want and press **OK**.

5 Scanning begins.



Scanned image is saved in computer's **C:\Users\users name\Pictures\folder**. The saved folder may differ, depending on your operating system or the application you are using.

Scanning from image editing program

You can scan and import documents at the image editing software such as Adobe Photoshop, if the software is TWAIN-compliant. Follow the steps below to scan with TWAIN-compliant software:

Scan features

- 1 Make sure that the machine is connected to your computer and powered on.
- 2 Place a single document face down on the document glass, or load the documents face up into the document feeder (see "Loading originals" on page 42).
- 3 Open an application, such as Adobe Photoshop.
- 4 Click **File > Import**, and select the scanner device.
- 5 Set the scan options.
- 6 Scan and save your scanned image.

Scanning using the WIA driver

Your machine supports the Windows Image Acquisition (WIA) driver for scanning images. WIA is one of the standard components provided by Microsoft Windows 7 and works with digital cameras and scanners. Unlike the TWAIN driver, the WIA driver allows you to scan and easily adjust images without using additional software:



The WIA driver works only on Windows OS (not supported Windows 2000) with a USB port.

- 1 Make sure that the machine is connected to your computer and powered on.
- 2 Place a single document face down on the document glass, or load the documents face up into the document feeder (see "Loading originals" on page 42).
- 3 Click **Start > Control Panel > Hardware and Sound > Devices and Printers**.
- 4 Right-click on device driver icon in **Printers and Faxes > Start Scan**.
- 5 **New Scan** application appears.
- 6 Choose your scanning preferences and click **Preview** to see your preferences affect the picture.
- 7 Scan and save your scanned image.



Scanning with Dell Scan Assistant



You can use the OCR (Optical Character Reader) feature from Dell Scan Assistant program.

Scan features

- 1 Make sure that the machine is connected to your computer and powered on.
- 2 Place a single document face down on the document glass, or load the documents face up into the document feeder (see "Loading originals" on page 42).
- 3 Click **Start > All programs > Dell**, and start **Dell Scan Assistant**.



 Select the **Help** menu or click the  button from the window and click on any option you want to know about.



- 4 Set the scan options.
- 5 Click **Scan**.

Scanning with SmarThru Office

 You can use the OCR (Optical Character Reader) feature from SmarThru Office program.

- 1 Make sure that the machine is connected to your computer and powered on.
- 2 Place a single document face down on the document glass, or load the documents face up into the document feeder (see "Loading originals" on page 42).
- 3 Double-click the **SmarThru Office** icon.
- 4 The **SmarThru Office** appears.

 Click the **Help** or  button from the window and click on any option you want to know about.

- 5 Click the **SmarThru Office** icon () in the tray area of the Windows taskbar to activate the **SmarThru Office** launcher.
- 6 Click the scanning icon () to open the scanning window.
- 7 The **Scan Setting** window opens.
- 8 Set scan settings and click **Scan**.

Scan features

Macintosh scanning

Scanning from network connected machine

- 1 Make sure that your machine is connected to a network.
- 2 Place a single document face down on the document glass, or load the documents face up into the document feeder (see "Loading originals" on page 42).
- 3 Start **Applications** and click **Image Capture**.
- 4 According to OS, follow steps below.
 - For 10.4
 - Click **Devices > Browse Devices** on Menu bar.
 - Select your machine in Twain devices option. Make sure that **Use TWAIN software** checkbox is checked.
 - Click **Connect**.

If a warning message appears, click **Change Port..** to select port, or If TWAIN UI appears, click **Change Port..** from the **Preference** tab and select a new port.
 - For 10.5
 - Click **Devices > Browse Devices** on Menu bar.

- Make sure that **Connected** checkbox is checked beside your machine in **Bonjour Devices**.
- If you want to scan using TWAIN, refer to the Mac OS X10.4 steps above.
- For 10.7 or higher, select your device below **SHARED**.

5 Set the scan options on this program.

6 Scan and save your scanned image.



- If scanning does not operate in Image Capture, update Mac OS to the latest version. Image Capture operates properly Mac OS X 10.4.7 or higher.
- For more information, refer to the **Image Capture's** help.
- You can also scan using TWAIN-compliant software, such as Adobe Photoshop.

Scan features

Linux scanning

Scanning

- 1 Make sure that the machine is connected to your computer and powered on.
- 2 Double-click the **Unified Driver Configurator** on your desktop.
- 3 Click the  button to switch to Scanners Configuration.

- 4 Select the scanner on the list.

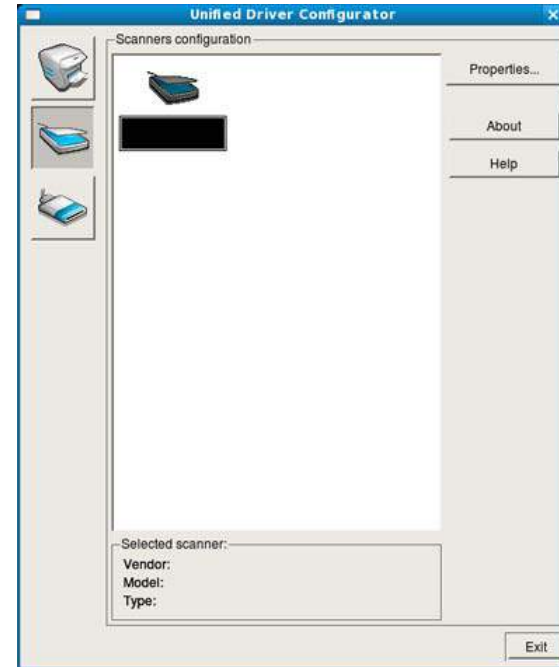

- 5 Click **Properties**.
- 6 Place a single document face down on the document glass, or load the documents face up into the document feeder (see "Loading originals" on page 42).
- 7 From the **Scanner Properties** window, click **Preview**.

Scan features

- 8 The document is scanned and the image preview appears in the **Preview Pane**.

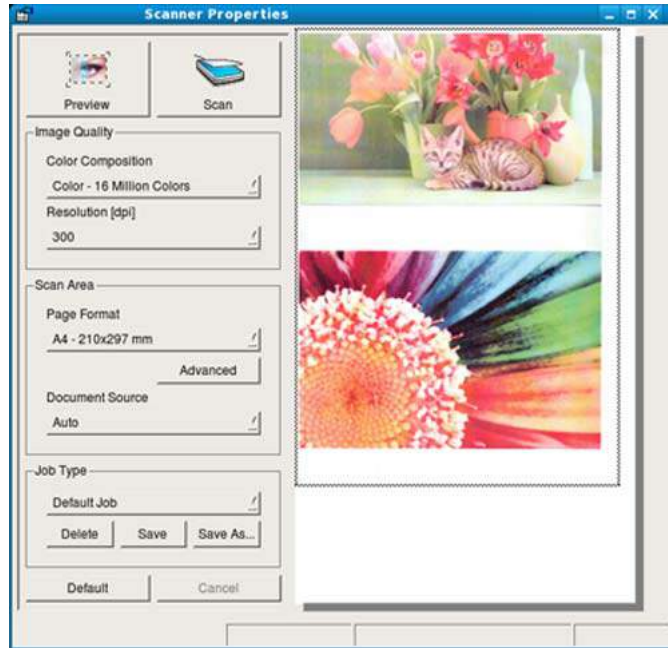

- 9 Drag the pointer to set the image area to be scanned in the **Preview Pane**.

- 10 Select the option you want.

- 11 Scan and save your scanned image.



For later use, you can save as your scan settings and add it to the **Job Type** drop-down list.

Editing an image with Image Manager

The Image Manager application provides you with menu commands and tools to edit your scanned image.

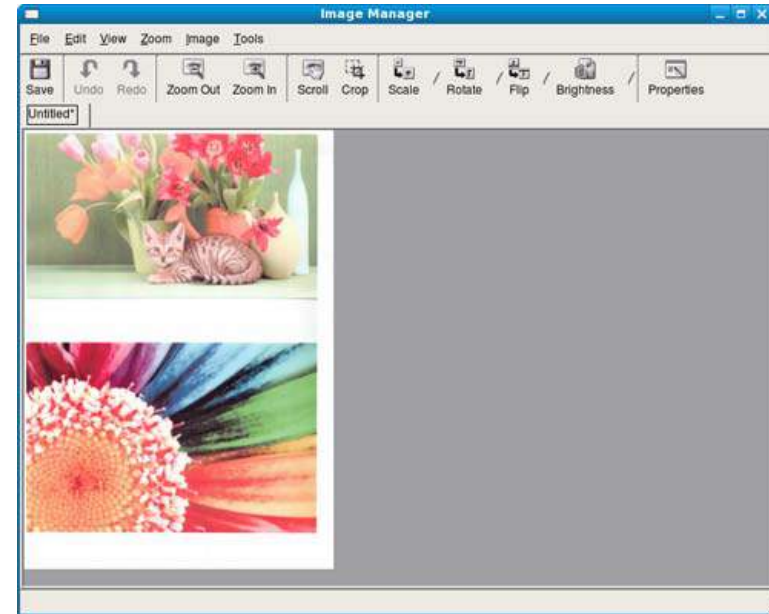



Fax features





For basic faxing features, refer to the Basic Guide (see "Basic faxing" on page 56).

Automatic redialing

When the number you have dialed is busy or there is no answer when you send a fax, the machine automatically redials the number. The redial time depends on the country's factory default setting.

When the display shows **Retry Redial?**, press  (**Start**) button to redial the number without waiting. To cancel the automatic redialing, press  (**Stop/Clear**).

To change the time interval between redials and the number of redial attempts.

- 1 Press  (fax) >  (**Menu**) > **Fax Setup** > **Sending** on the control panel.
- 2 Select **Redial Times** or **Redial Term** you want.
- 3 Select the option you want.

Redialing the fax number

- 1 Press  (**Redial/Pause**) button on the control panel.
- 2 Select the fax number you want.
Ten recently sent fax numbers with ten received Caller IDs are shown.
- 3 When an original is loaded in the document feeder, the machine automatically begins to send.
If an original is placed on the scanner glass, select **Yes** to add another page. Load another original and press **OK**. When you have finished, select **No** when **Another Page?** appears.



Confirming a transmission

When the last page of your original has been sent successfully, the machine beeps and returns to ready mode.

When something goes wrong while sending your fax, an error message appears on the display. If you receive an error message, press  (**Stop/Clear**) to clear the message and try to send the fax again.

Fax features



You can set your machine to print a confirmation report automatically each time sending a fax is completed. Press  (fax) >  (**Menu**) > **Fax Setup** > **Sending** > **Send Report** on the control panel.

Sending a fax in the computer

You can send a fax from your computer without going to the machine.

To send a fax from your computer, the **Dell Network PC Fax** program must be installed. This program will be installed when you installed the printer driver.

- 1 Open the document to be sent.
- 2 Select **Print** from the **File** menu.
The **Print** window will be displayed. It may look slightly different depending on your application.
- 3 Select **Dell Network PC Fax** from the **Print** window
- 4 Click **Print** or **OK**.

- 5 Enter the recipients' numbers and select the option

#	Name	Fax Number
---	------	------------

Fax number





Select the **Help** menu or click the  button from the window and click on any option you want to know about.

- 6 Click **Send**.

Fax features

Delaying a fax transmission

You can set your machine to send a fax at a later time when you will not be present. You cannot send a color fax using this feature.

- 1 Place a single document face down on the document glass, or load the documents face up into the document feeder.
- 2 Press  (fax) on the control panel.
- 3 Adjust the resolution and the darkness to suit your fax needs.
- 4 Press  **(Menu)** > **Fax Feature** > **Delay Send** on the control panel.
- 5 Enter the number of the receiving fax machine and press **OK**.
- 6 The display asks you to enter another fax number to send the document.
- 7 To enter more fax numbers, press **OK** when **Yes** highlights and repeat steps 5.



- You can add up to 10 destinations.
- Once you entered a group dial number, you cannot enter another group dial numbers anymore.

- 8 Enter the job name and the time.



If you set a time earlier than the current time, the fax will be sent at that time on the following day.

- 9 The original is scanned into memory before transmission.



The machine returns to ready mode. The display reminds you that you are in ready mode and that a delayed fax is set.



You can check the list of delayed fax jobs.



Press  **(Menu)** > **System Setup** > **Report** > **Schedule Jobs** on the control panel.

Adding documents to a reserved fax

- 1 Place a single document face down on the document glass, or load the documents face up into the document feeder.
- 2 Press  (fax) >  **(Menu)** > **Fax Feature** > **Add Pages** on the control panel.
- 3 Select the fax job and press **OK**.
When you have finished, select **No** when **Another Page?** appears. The machine scans the original into memory.
- 4 Press  **(Stop/Clear)** to return to ready mode.



Fax features

Canceling a reserved fax job

- 1 Press  (fax) >  (Menu) > **Fax Feature** > **Cancel Job** on the control panel.
- 2 Select the fax job you want and press **OK**.
- 3 Press **OK** when **Yes** highlights.
The selected fax is deleted from memory.
- 4 Press  (**Stop/Clear**) to return to ready mode.

Sending a priority fax

This function is used when a high priority fax need to be sent ahead of reserved operations. The original is scanned into memory and immediately transmitted when the current operation is finished.

- 1 Place a single document face down on the document glass, or load the documents face up into the document feeder.
- 2 Press  (**Fax**) >  (Menu) > **Fax Feature** > **Priority Send** on the control panel.
- 3 Enter the destination fax number and press **OK**.
- 4 Enter the job name and press **OK**.

- 5 If an original is placed on the scanner glass, select **Yes** to add another pages. Load another original and press **OK**.

When you have finished, select **No** when **Another Page?** appears.



The machine starts to scan and send a fax to destinations.

Forwarding a sent fax to another destination

You can set the machine to forward the received or sent fax to other destination by a fax. If you are out of office but have to receive the fax, this feature may be useful.



- When you forward a fax by an email, you must first set the mail server and IP address in Embedded Web Service (see "Using Embedded Web Service" on page 186).
- Though you sent or received a color fax, the data is forwarded in grayscale.

- 1 Place a single document face down on the document glass, or load the documents face up into the document feeder.
- 2 Press  (fax) >  (Menu) > **Fax Feature** > **Forward** > **Fax** > **Send Forward** > **On** on the control panel.

Fax features



Forward options may not be available depending on model or optional goods (see "Variety feature" on page 7).

- 3 Enter the destination fax number and press **OK**.
- 4 Press  (**Stop/Clear**) to return to ready mode.
Subsequent sent faxes will be forwarded to the specified fax machine.

Forwarding a received fax

You can set the machine to forward the received or sent fax to other destination by a fax. If you are out of office but have to receive the fax, this feature may be useful.



Though you sent or received a color fax, the data is forwarded in grayscale.

- 1 Press  (fax) >  (**Menu**) > **Fax Feature** > **Forward** > **Fax, Email, or Server** > **Receive Forward** > **Forward** on the control panel.



Forward options may not be available depending on model or optional goods (see "Variety feature" on page 7).

- 2 To set the machine to print out a fax when fax forwarding has been completed, select **Forward & Print**.
- 3 Enter the destination fax number, email address, or server address and press **OK**.
- 4 Enter the starting time and ending time, then press **OK**.
- 5 Press  (**Stop/Clear**) to return to ready mode.
Subsequent sent faxes will be forwarded to the specified fax machine.

Receiving a fax in the computer



- This feature may not be available depending on model or optional goods (see "Features" on page 6).
- To use this feature, set the option on the control panel:

Press  (fax) >  (**Menu**) > **Fax Feature** > **Forward** > **PC** > **On** the control panel.





- 1 Open the **Dell Printer Manager**.
- 2 Select the appropriate machine from the **Printer List**.
- 3 Select **Fax to PC Settings** menu.

Fax features

- 4 Use **Set Fax Receiving** to change the fax settings.
 - **Enable Fax Receiving** From Device: Select whether to use or not.
 - **Image Type:** Convert the received faxes to PDF or TIFF.
 - **Save Location:** Select location to save the converted faxes.
 - **Prefix:** Select file or folder scheme as prefix.
 - **Print received fax:** After receiving the fax, set prints information for the received fax.
 - **Notify me when complete:** Set to show the popup window to notify receiving a fax.
 - **Open with default application:** After receiving the fax, open it with default application.
 - **None:** After receiving a fax, the machine does not notify the user or opens the application.

- 5 Press **OK**.

Changing the receive modes

- 1 Press  (fax) >  (**Menu**) > **Fax Setup** > **Receiving** > **Receive Mode** on the control panel.
- 2 Select the option you want.
 - **Fax:** Answers an incoming fax call and immediately goes into the fax reception mode.
 - **Tel:** Receives a fax by pressing  (**On Hook Dial**) and then  (**Start**) button.
 - **Ans/Fax:** Is for when an answering machine attached to your machine. Your machine answers an incoming call, and the caller can leave a message on the answering machine. If the fax machine senses a fax tone on the line, the machine automatically switches to Fax mode to receive the fax.



To use the **Ans/Fax** mode, attach an answering machine to the EXT socket on the back of your machine.

- **DRPD:** you can receive a call using the Distinctive Ring Pattern Detection (DRPD) feature. Distinctive Ring is a telephone company service which enables an user to use a single telephone line to answer several different telephone numbers. For further details, see "Receiving faxes using DRPD mode" on page 181.

Fax features



This setting may not be available depending on your country.



3

Press **OK**.

4

Press  (**Stop/Clear**) to return to ready mode.

Receiving manually in Tel mode

You can receive a fax call by pressing  (**On Hook Dial**) button and then pressing  (**Start**) when you hear a fax tone. If your machine has a handset, you can answer calls using the handset (see "Features" on page 6).

Receiving in Answering Machine/Fax mode

To use this mode, you must attach an answering machine to the EXT socket on the back of your machine. If the caller leaves a message, the answering machine stores the message. If your machine detects a fax tone on the line, it automatically starts to receive the fax.



- If you have set your machine to this mode and your answering machine is switched off, or no answering machine is connected to EXT socket, your machine automatically goes into Fax mode after a predefined number of rings.
- If the answering machine has a user-selectable ring counter, set the machine to answer incoming calls within 1 ring.
- If the machine is in Tel mode, disconnect or switch off the answering machine with the fax machine. Otherwise, the outgoing message from the answering machine will interrupt your phone conversation.

Receiving faxes with an extension telephone

When you are using an extension telephone connected to the EXT socket, you can receive a fax from someone you are talking to on the extension telephone, without going to the fax machine.

When you receive a call on the extension phone and hear fax tones, press the keys ***9*** on the extension phone. The machine receives the fax.

9 is the remote receive code preset at the factory. The first and the last asterisks are fixed, but you can change the middle number to whatever you want.





While you are talking over the telephone connected to the EXT socket, copy and scan features are not available.

Fax features

Receiving faxes using DRPD mode

Distinctive Ring is a telephone company service which enables an user to use a single telephone line to answer several different telephone numbers. This feature is often used by answering services who answer telephones for many different clients and need to know which number someone is calling in on to properly answer the phone.

1 Select  (fax) >  (**Menu**) > **Fax Setup** > **Receiving** > **DRPD Mode** > **Waiting Ring** on the control panel.

2 Call your fax number from another telephone.

3 When your machine begins to ring, do not answer the call. The machine requires several rings to learn the pattern.

When the machine completes learning, the display shows **Completed DRPD Setup**. If the DRPD setup fails, **Error DRPD Ring** appears.



4 Press **OK** when DRPD appears and start over from step 2.

-  DRPD must be set up again if you re-assign your fax number, or connect the machine to another telephone line.
- After DRPD has been set up, call your fax number again to verify that the machine answers with a fax tone. Then have a call placed to a different number assigned to that same line to be sure the call is forwarded to the extension telephone or answering machine plugged into the EXT socket.



Receiving in secure receiving mode

 This feature may not be available depending on model or optional goods (see "Features" on page 6).

You may need to prevent your received faxes from being accessed by unauthorized people. Turn on secure receiving mode, then all incoming faxes go into memory. You can print the incoming faxes with entering the password.

 To use the secure receiving mode, activate the menu from  (fax) >  (**Menu**) > **Fax Feature** > **Secure Receive** on the control panel.

Printing received faxes

1 Select  (fax) >  (**Menu**) > **Fax Feature** > **Secure Receive** > **Print** on the control panel.

2 Enter a four-digit password and press **OK**.



3 The machine prints all of the faxes stored in memory.

Fax features

Printing faxes on both sides of the paper



- Some menus may not appear on the display depending on options or models. If so, it is not applicable to your machine.
- This feature may not be available depending on model or optional goods (see "Features" on page 6).

- 1 Place a single document face down on the document glass, or load the documents face up into the document feeder.
- 2 Press  (fax) >  (**Menu**) > **Fax Setup** > **Receiving** > **Duplex Print** on the control panel.

- **Off:** Prints in Normal mode.
- **Long Edge:** Prints pages to be read like a book.

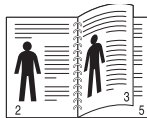

- **Short Edge:** Prints pages to be read by flipping like a note pad.



- 3 Press **OK**.
- 4 Press  (**Stop/Clear**) to return to ready mode.

Receiving faxes in memory



Since your machine is a multi-tasking device, it can receive faxes while you are making copies or printing. If you receive a fax while you are copying or printing, your machine stores incoming faxes in its memory. Then, as soon as you finish copying or printing, the machine automatically prints the fax.



If fax is received and being printed, other copy and print jobs cannot be processed at the same time.

Printing sent fax report automatically

You can set the machine to print a report with detailed information about the previous 50 communication operations, including time and dates.

- 1 Press  (fax) >  (**Menu**) > **Fax Setup** > **Auto Report** > **On** on the control panel.
- 2 Press  (**Stop/Clear**) to return to ready mode.



5. Useful Management Tools

This chapter introduces management tools provided to help you make full use of your machine.

- **Using Firmware update utility** 184
- **Using Dell Supplies Ordering Utility** 185
- **Using Embedded Web Service** 186
- **Using Dell Printer Manager** 188
- **Using Dell Printer Status** 191
- **Using the Linux Unified Driver Configurator** 193

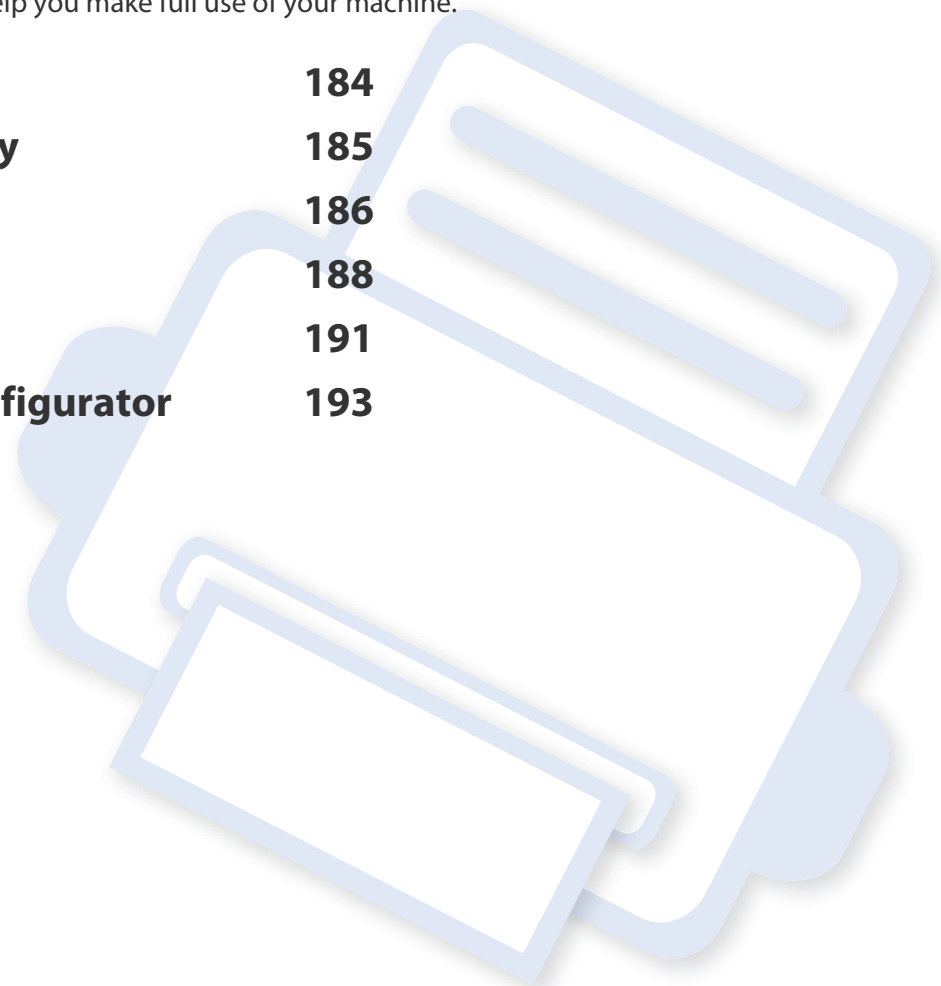

Using Firmware update utility

Firmware Update Utility allows you to maintain your machine by upgrading firmware.

- 1 From the **Start** menu, select **Programs** or **All Programs** > **Dell** > **Dell Printers** > **your printer driver name** > **Firmware Update Utility**.
- 2 Download the latest firmware. Click <http://www.support.dell.com>.
- 3 If your printer is connected with an USB cable, click **USB Connected Printer** or **Network Connected Printer**.

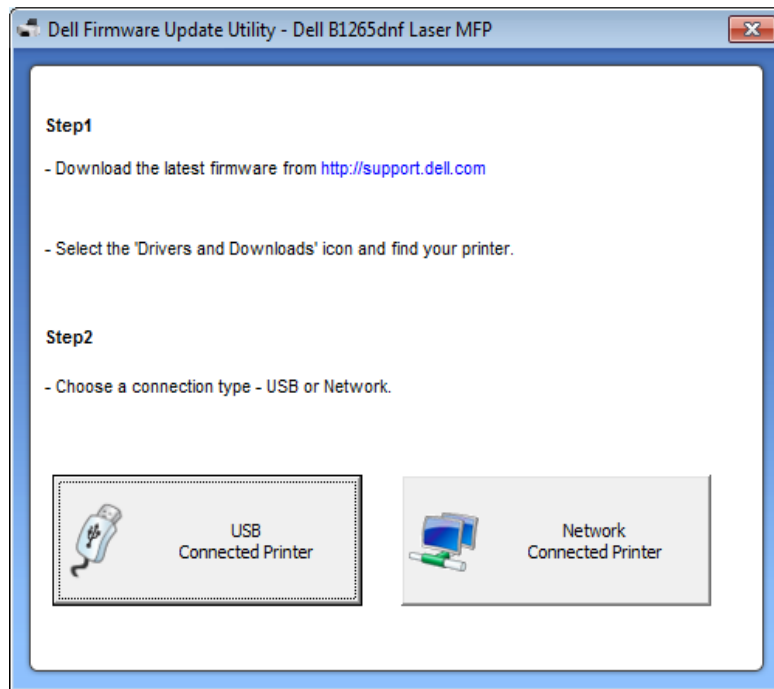

- 4 Click **Browse** and select the downloaded firmware file.
- 5 Click **Update Firmware**.

Using Dell Supplies Ordering Utility

To order replacement toner cartridges or supplies from Dell:



Available for Windows or Macintosh OS users only.

1 Double-click the **Dell Supplies Ordering Utility** icon on your desktop.



OR

From the **Start** menu, select **Programs** or **All Programs > Dell > Dell Printers > your printer driver name > Dell Supplies Ordering Utility**.



For Macintosh,

Open the **Applications** folder > **Dell** folder > **Dell Supplies Ordering Utility**.

2 The **Dell Supplies Ordering Utility** window opens.



Using Embedded Web Service



- Internet Explorer 6.0 or higher is the minimum requirement for Embedded Web Service.
- Embedded Web Service explanation in this user's guide may differ from your machine depending on its options or models.
- Network model only (see "Software" on page 6).

Accessing Embedded Web Service

- 1 Access a web browser, such as Internet Explorer, from Windows.
Enter the machine IP address of your printer (<http://xxx.xxx.xxx.xxx>) in the address field and press the Enter key or click **Go**.
- 2 Your machine's embedded website opens.

Logging into Embedded Web Service

Before configuring options in Embedded Web Service, you need to log-in as an administrator. You can still use Embedded Web Service without logging in but you won't have access to **Settings** tab and **Security** tab.

- 1 Click **Login** on the upper right of the Embedded Web Service website.
- 2 Type in the **ID** and **Password** then click **Login**.
 - **ID: admin**
 - **Password: dell00000**

Embedded Web Service overview



Some tabs may not appear depending on your model.



Information

Settings

Security

Maintenance

Information tab

This tab gives you general information about your machine. You can check things, such as remaining amount of toner. You can also print reports, such as an error report.

- **Active Alerts:** Shows the alerts that have occurred in the machine and their severity.
- **Supplies:** Shows how many pages are printed and amount of toner left in the cartridge.

Using Embedded Web Service

- **Usage Counters:** Shows the usage count by print types: simplex and duplex.
- **Current Settings:** Shows the machine's and network's information.
- **Print information:** Prints reports such as system related reports, e-mail address, and font reports.

Settings tab

This tab allows you to set configurations provided by your machine and network. You need to log-in as an administrator to view this tab.

- **Machine Settings** tab: Sets options provided by your machine.
- **Network Settings** tab: Shows options for the network environment. Sets options such as TCP/IP and network protocols.

Security tab

This tab allows you to set system and network security information. You need to log-in as an administrator to view this tab.

- **System Security:** Sets the system administrator's information and also enables or disables machine features.
- **Network Security:** IPv4/IPv6 filtering.

Maintenance tab

This tab allows you to maintain your machine by upgrading firmware and setting contact information for sending emails. You can also connect to Dell website or download drivers by selecting the **Link** menu.

- **Firmware Upgrade:** Upgrade your machine's firmware.
- **Contact Information:** Shows the contact information.
- **Link:** Shows links to useful sites where you can download or check information.

Using Dell Printer Manager



- Available for Windows and Macintosh OS users only (see "Software" on page 6).
- For Windows, Internet Explorer 6.0 or higher is the minimum requirement for Dell Printer Manager.

Dell Printer Manager is an application that combines Dell machine settings into one location. Dell Printer Manager combines device settings as well as printing environments, settings/actions and launching. All of these features provide a gateway to conveniently use your Dell machine. Dell Printer Manager provides two different user interfaces for the user to choose from: the basic user interface and the advanced user interface. Switching between the two interfaces is easy: just click a button.

Understanding Dell Printer Manager

To open the program:

For Windows,

Select **Start > Programs** or **All Programs > Dell > Dell Printers > Dell Printer Manager > Dell Printer Manager**.

For Macintosh,

Open the **Applications** folder > **Dell** folder > **Dell Printer Manager**.

The Dell Printer Manager interface is comprised of various basic sections as described in the table that follows:





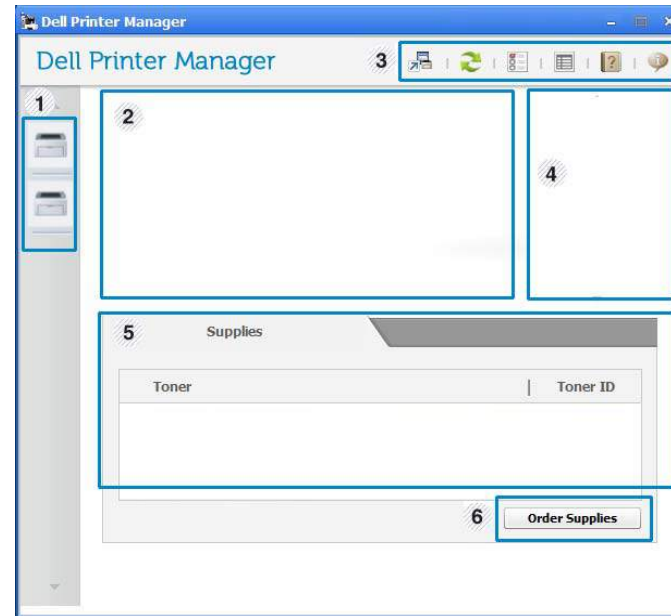

The screenshot may differ depending on operating system you are using.



1	Printer list	The Printer List displays printers installed on your computer and network printers added by network discovery (Windows only).
---	--------------	---

Using Dell Printer Manager

2	Printer information	<p>This area gives you general information about your machine. You can check information, such as the machine's model name, IP address (or Port name), and machine status.</p> <p> You can view the online User's Guide.</p>
3	Application information	<p>Includes links for changing to the advanced settings, preference, help, and about.</p> <p> The  button is used to change the user interface to the advanced settings user interface (see "Advanced settings user interface overview" on page 189).</p>
4	Quick links	<p>Displays Quick links to machine specific functions. This section also includes links to applications in the advanced settings.</p> <p> If you connect your machine to a network, the Embedded Web Service icon is enabled.</p>

5	Contents area	<p>Displays information about the selected machine, remaining toner level, and paper. The information will vary based on the machine selected. Some machines do not have this feature.</p>
6	Order supplies	<p>Click on the Order button from the supply ordering window. You can order replacement toner cartridge(s) from online.</p>



Select the **Help** menu or click the  button from the window and click on any option you want to know about.

Advanced settings user interface overview

The advanced user interface is intended to be used by the person responsible for managing the network and machines.



Some menus may not appear in the display depending on options or models. If so, it is not applicable to your machine.

Using Dell Printer Manager

Device Settings

You can configure various machine settings such as machine setup, paper, layout, emulation, network, and print information.

Scan to PC Settings

This menu includes settings to create or delete scan to PC profiles.

- **Scan Activation:** Determines whether or not scanning is enabled on the device.
- **Profile:** Displays the scanning profiles saved on the selected device.
- **Basic tab:** Contains settings related general scan and device settings.
- **Image tab:** Contains settings related to image altering.

Fax to PC Settings

This menu includes settings related to the basic fax functionality of the selected device.

- **Disable:** If **Disable** is **On**, incoming faxes will not be received on this device.
- **Enable Fax Receiving from Device:** Enables faxing on the device and allow more options to be set.

Alert Settings (Windows only)

This menu includes settings related to error alerting.

- **Printer Alert:** Provides settings related to when alerts will be received.
- **Email Alert:** Provides options relating to receiving alerts via email.
- **Alert History:** Provides a history of device and toner related alerts.

Using Dell Printer Status

The Dell Printer Status is a program that monitors and informs you of the machine status.



- The Dell Printer Status window and its contents shown in this user's guide may differ depending on the machine or operating system in use.
- Check the operating system(s) that are compatible with your machine (see "Specifications" on page 92).
- Available for Windows OS users only (see "Software" on page 6).

Dell Printer Status overview

If an error occurs while operating, you can check the error from the Dell Printer Status. Dell Printer Status is installed automatically when you install the machine software.

You can also launch Dell Printer Status manually. Go to the **Printing Preferences**, click the **Basic** tab > **Printer Status** button.

These icons appear on the Windows task bar:

Icon	Mean	Description
	Normal	The machine is in ready mode and experiencing no errors or warnings.
	Warning	The machine is in a state where an error might occur in the future. For example, it might be in toner low status, which may lead to toner empty status.
	Error	The machine has at least one error.

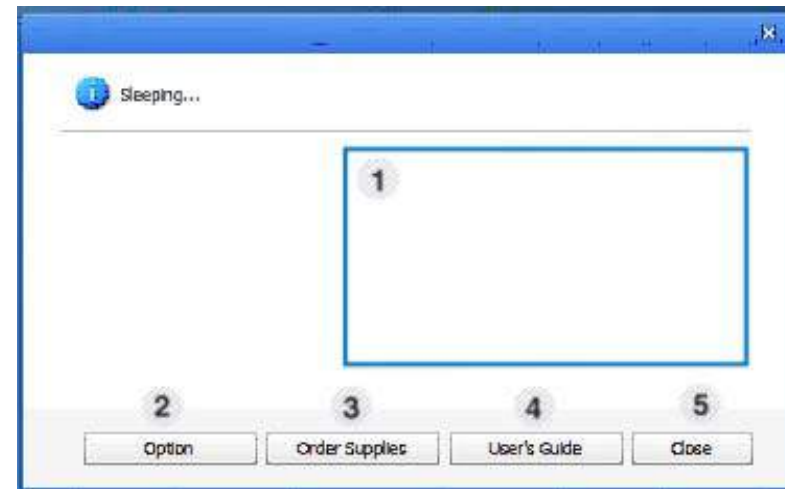

1	Toner Level	You can view the level of toner remaining in each toner cartridge. The machine and the number of toner cartridge(s) shown in the above window may differ depending on the machine in use. Some machines do not have this feature.
---	--------------------	---

Using Dell Printer Status

2	Option	You can set printing job alert related settings.
3	Order Supplies	You can order replacement toner cartridge(s) from online.
4	User's Guide	You can view the online User's Guide.
5	Close	Close the window.

Using the Linux Unified Driver Configurator

The Unified Driver Configurator is a tool primarily intended for configuring machine devices. You need to install Unified Linux Driver to use Unified Driver Configurator (see "Installation for Linux" on page 113).

After the driver is installed on your Linux system, the Unified Driver Configurator icon will automatically be created on your desktop.

Opening Unified Driver Configurator

- 1 Double-click the **Unified Driver Configurator** on the desktop. You can also click the **Startup** Menu icon and select **Dell Unified Driver > Unified Driver Configurator**.
- 2 Click each button on the left to switch to the corresponding configuration window.

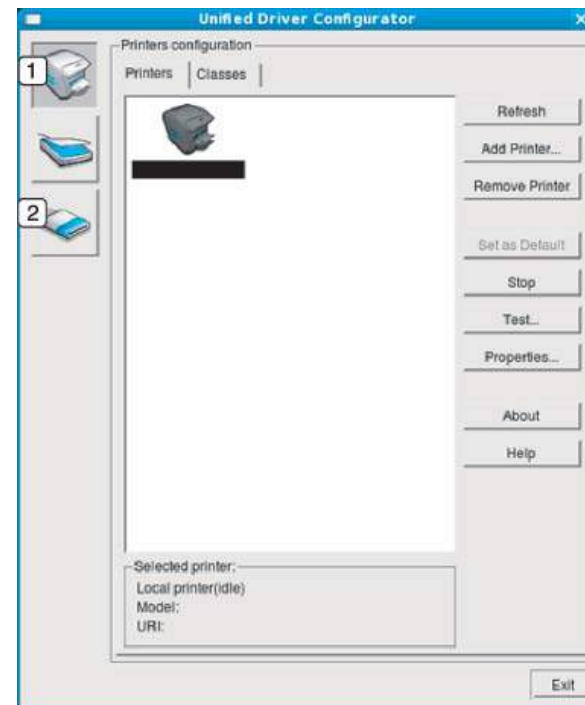

- 1 **Printer Configuration**
- 2 **Port Configuration**

Using the Linux Unified Driver Configurator



To use the on screen help, the **Help** or **?** button from the window.

- 3 After changing the configurations, click **Exit** to close the **Unified Driver Configurator**.

Printers configuration

Printers configuration has the two tabs: **Printers** and **Classes**.

Printers tab

View the current system's printer configuration by clicking on the machine icon button on the left side of the **Unified Driver Configurator** window.

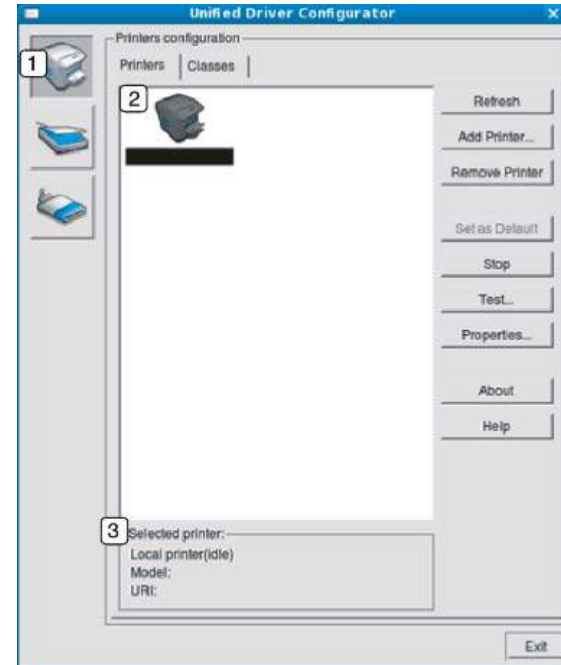

- | | |
|---|--|
| 1 | Switches to Printers configuration . |
| 2 | Shows all of the installed machines. |
| 3 | Shows the status, model name, and URI of your machine. |

Using the Linux Unified Driver Configurator

The printer control buttons are, as follows:

- **Refresh:** Renews the available machines list.
- **Add Printer:** Allows you to add a new machines.
- **Remove Printer:** Removes the selected machine.
- **Set as Default:** Sets the current selected machine as a default machine.
- **Stop/Start:** Stops/starts the machine.
- **Test:** Allows you to print a test page to ensure the machine is working properly.
- **Properties:** Allows you to view and change the printer's properties.

Classes tab

The Classes tab shows a list of available machine classes.

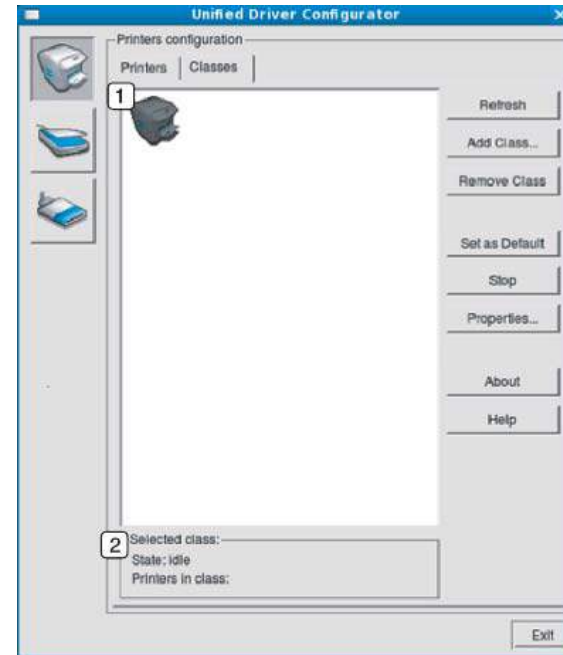

- | | |
|---|--|
| 1 | Shows all of the machine classes. |
| 2 | Shows the status of the class and the number of machines in the class. |

- **Refresh:** Renews the classes list.
- **Add Class:** Allows you to add a new machine class.
- **Remove Class:** Removes the selected machine class.

Using the Linux Unified Driver Configurator

Ports configuration

In this window, you can view the list of available ports, check the status of each port and release a port that is stalled in a busy state when its owner has terminated the job for any reason.

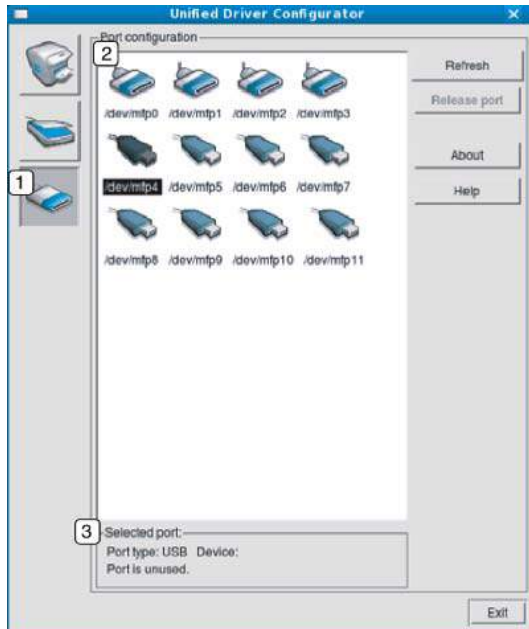

1	Switches to Ports configuration .
2	Shows all of the available ports.
3	Shows the port type, device connected to the port, and status.

- **Refresh:** Renews the available ports list.
- **Release port:** Releases the selected port.



6. Troubleshooting

This chapter gives helpful information for what to do if you encounter an error.

- **Paper feeding problems** 198
- **Power and cable connecting problems** 199
- **Printing problems** 200
- **Printing quality problems** 203
- **Copying problems** 211
- **Scanning problems** 212
- **Faxing problems** 214
- **Operating system problems** 216

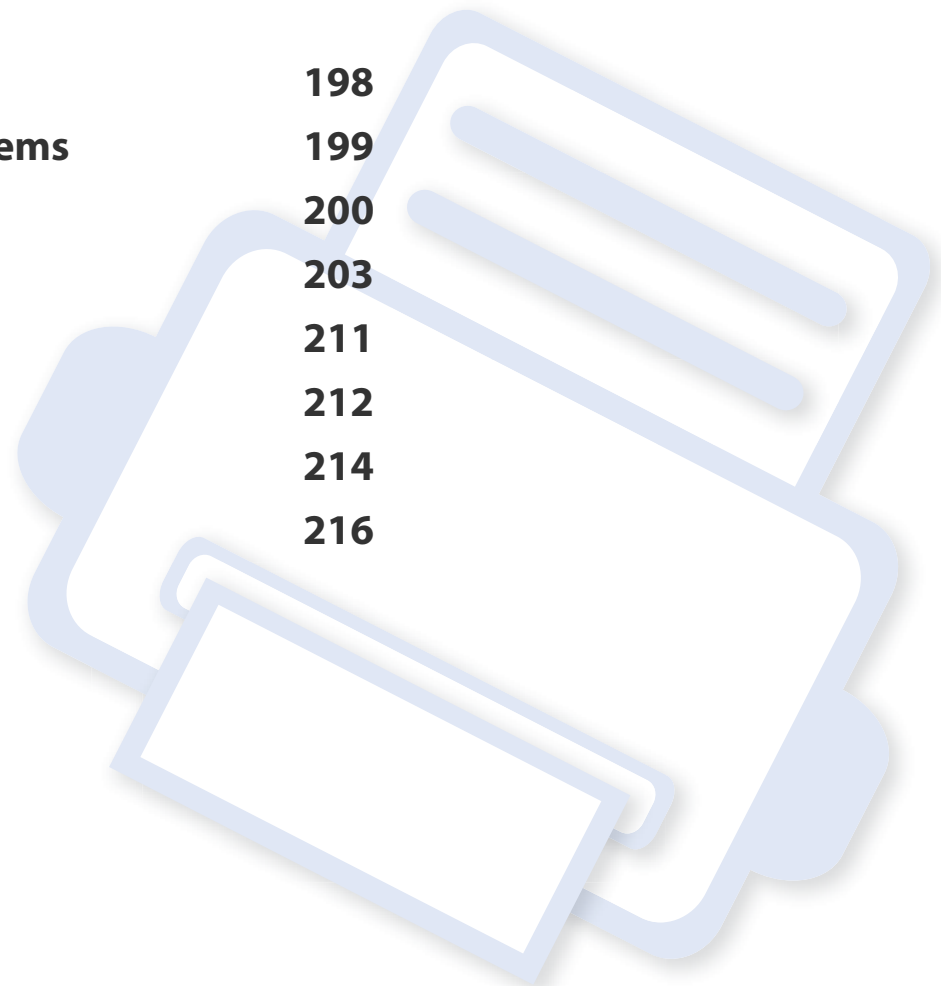

Paper feeding problems

Condition	Suggested solutions
Paper jams during printing.	Clear the paper jam.
Paper sticks together.	<ul style="list-style-type: none">• Check the maximum paper capacity of the tray.• Make sure that you are using the correct type of paper.• Remove paper from the tray and flex or fan the paper.• Humid conditions may cause some paper to stick together.
Multiple sheets of paper do not feed.	Different types of paper may be stacked in the tray. Load paper of only one type, size, and weight.
Paper does not feed into the machine.	<ul style="list-style-type: none">• Remove any obstructions from inside the machine.• Paper has not been loaded correctly. Remove paper from the tray and reload it correctly.• There is too much paper in the tray. Remove excess paper from the tray.• The paper is too thick. Use only paper that meets the specifications required by the machine.
The paper keeps jamming.	<ul style="list-style-type: none">• There is too much paper in the tray. Remove excess paper from the tray. If you are printing on special materials, use the manual feeding in tray.• An incorrect type of paper is being used. Use only paper that meets the specifications required by the machine.• There may be debris inside the machine. Open the front cover and remove any debris.
Transparencies stick together in the paper exit.	Use only transparencies specifically designed for laser printers. Remove each transparency as it exits from the machine.
Envelopes skew or fail to feed correctly.	Ensure that the paper guides are against both sides of the envelopes.

Power and cable connecting problems

Condition	Suggested solutions
The machine is not receiving power, or the connection cable between the computer and the machine is not connected properly.	<ul style="list-style-type: none"><li data-bbox="658 300 2168 341">• Connect the machine to the electricity supply first. If the machine has a  (Power) button on the control, press it.<li data-bbox="658 363 1323 405">• Disconnect the machine's cable and reconnect it.

Printing problems

Condition	Possible cause	Suggested solutions
The machine does not print.	The machine is not receiving power.	Connect the machine to the electricity supply first. If the machine has a  (Power) button on the control, press it.
	The machine is not selected as the default machine.	Select your machine as your default machine in Windows.
	Check the machine for the following:	
	<ul style="list-style-type: none">• The cover is not closed. Close the cover.• Paper is jammed. Clear the paper jam (see "Clearing paper jams" on page 80).• No paper is loaded. Load paper (see "Loading paper in the tray" on page 33).• The toner cartridge is not installed. Install the toner cartridge (see "Replacing the toner cartridge" on page 66).• Make sure the protect cover and sheets are removed from the toner cartridge (see "Replacing the toner cartridge" on page 66).	
	If a system error occurs, contact your service representative.	
	The connection cable between the computer and the machine is not connected properly.	Disconnect the machine cable and reconnect it (see "Rear view" on page 17).
	The connection cable between the computer and the machine is defective.	If possible, attach the cable to another computer that is working properly and print a job. You can also try using a different machine cable.
The port setting is incorrect.	Check the Windows printer settings to make sure that the print job is sent to the correct port. If the computer has more than one port, make sure that the machine is attached to the correct one.	

Printing problems



Condition	Possible cause	Suggested solutions
The machine does not print.	The machine may be configured incorrectly.	Check the Printing Preferences to ensure that all of the print settings are correct.
	The printer driver may be incorrectly installed.	Uninstall and reinstall the machine's driver.
	The machine is malfunctioning.	Check the display message on the control panel to see if the machine is indicating a system error. Contact a service representative.
	The document size is so big that the hard disk space of the computer is insufficient to access the print job.	Get more hard disk space and print the document again.
	The output tray is full.	Once the paper is removed from the output tray, the machine resumes printing.
The machine selects print materials from the wrong paper source.	The paper option that was selected in the Printing Preferences may be incorrect.	For many software applications, the paper source selection is found under the Paper tab within the Printing Preferences (see "Opening printing preferences" on page 47). Select the correct paper source. See the printer driver help screen (see "Using help" on page 48).
A print job is extremely slow.	The job may be very complex.	Reduce the complexity of the page or try adjusting the print quality settings.
Half the page is blank.	The page orientation setting may be incorrect.	Change the page orientation in your application (see "Opening printing preferences" on page 47). See the printer driver help screen (see "Using help" on page 48).
	The paper size and the paper size settings do not match.	Ensure that the paper size in the printer driver settings matches the paper in the tray. Or, ensure that the paper size in the printer driver settings matches the paper selection in the software application settings you use (see "Opening printing preferences" on page 47).
The machine prints, but the text is wrong, garbled, or incomplete.	The machine cable is loose or defective.	Disconnect the machine cable and reconnect. Try a print job that you have already printed successfully. If possible, attach the cable and the machine to another computer that you know works and try a print job. Finally, try a new machine cable.
	The wrong printer driver was selected.	Check the application's printer selection menu to ensure that your machine is selected.
	The software application is malfunctioning.	Try printing a job from another application.
	The operating system is malfunctioning.	Exit Windows and reboot the computer. Turn the machine off and back on again.

Printing problems

Condition	Possible cause	Suggested solutions
Pages print, but they are blank.	The toner cartridge is defective or out of toner.	Redistribute the toner, if necessary. If necessary, replace the toner cartridge. <ul style="list-style-type: none">• See "Redistributing toner" on page 65.• See "Replacing the toner cartridge" on page 66.
	The file may have blank pages.	Check the file to ensure that it does not contain blank pages.
	Some parts, such as the controller or the board, may be defective.	Contact a service representative.
The machine does not print PDF files correctly. Some parts of graphics, text, or illustrations are missing.	Incompatibility between the PDF file and the Acrobat products.	Printing the PDF file as an image may enable the file to print. Turn on Print As Image from the Acrobat printing options.  It will take longer to print when you print a PDF file as an image.
The print quality of photos is not good. Images are not clear.	The resolution of the photo is very low.	Reduce the photo size. If you increase the photo size in the software application, the resolution will be reduced.
Before printing, the machine emits vapor near the output tray.	Using damp paper can cause vapor during printing.	This is not a problem. Just keep printing.
The machine does not print special-sized paper, such as billing paper.	Paper size and paper size setting do not match.	Set the correct paper size in the Custom in Paper tab in Printing Preferences (see "Opening printing preferences" on page 47).
The printed billing paper is curled.	The paper type setting does not match.	Change the printer option and try again. Go to Printing Preferences , click Paper tab, and set type to Thick (see "Opening printing preferences" on page 47).

Printing quality problems

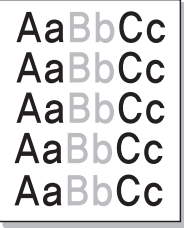

If the inside of the machine is dirty or paper has been loaded improperly, there might be a reduction in print quality. See the table below to clear the problem.

Condition	Suggested solutions
<p data-bbox="51 357 322 389">Light or faded print</p> 	<ul data-bbox="506 357 2186 751" style="list-style-type: none">• If a vertical white streak or faded area appears on the page, the toner supply is low. Install a new toner cartridge (see "Replacing the toner cartridge" on page 66).• The paper may not meet paper specifications; for example, the paper may be too moist or rough.• If the entire page is light, the print resolution setting is too low or the toner save mode is on. Adjust the print resolution and turn the toner save mode off. See the help screen of the printer driver.• A combination of faded or smeared defects may indicate that the toner cartridge needs cleaning. Clean the inside of your machine (see "Cleaning the machine" on page 69).• The surface of the LSU part inside the machine may be dirty. Clean the inside of your machine (see "Cleaning the machine" on page 69). If these steps do not correct the problem, contact a service representative.
<p data-bbox="51 786 472 903">The top half of the paper is printed lighter than the rest of the paper</p> 	<p data-bbox="506 786 1301 818">The toner might not adhere properly to this type of paper.</p> <ul data-bbox="506 842 2186 911" style="list-style-type: none">• Change the printer option and try again. Go to Printing Preferences, click the Paper tab, and set the paper type to Recycled (see "Opening printing preferences" on page 47).

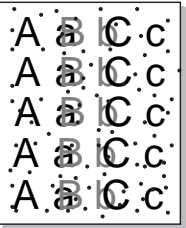
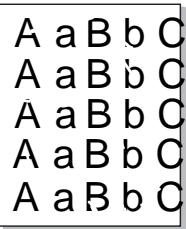
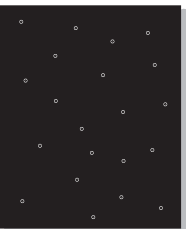
Printing quality problems

Condition	Suggested solutions
<p>Toner specks</p> 	<ul style="list-style-type: none">• The paper may not meet specifications; for example, the paper may be too moist or rough.• The transfer roller may be dirty. Clean the inside of your machine (see "Cleaning the machine" on page 69).• The paper path may need cleaning. Contact a service representative (see "Cleaning the machine" on page 69).
<p>Dropouts</p> 	<p>If faded areas, generally rounded, occur randomly on the page:</p> <ul style="list-style-type: none">• A single sheet of paper may be defective. Try reprinting the job.• The moisture content of the paper is uneven or the paper has moist spots on its surface. Try a different brand of paper.• The paper lot is bad. The manufacturing processes can cause some areas to reject toner. Try a different kind or brand of paper.• Change the printer option and try again. Go to Printing Preferences, click the Paper tab, and set type to Thick (see "Opening printing preferences" on page 47). <p>If these steps do not correct the problem, contact a service representative.</p>
<p>White Spots</p> 	<p>If white spots appear on the page:</p> <ul style="list-style-type: none">• The paper is too rough and a lot of dirt from paper falls to the inner components within the machine, so the transfer roller may be dirty. Clean the inside of your machine (see "Cleaning the machine" on page 69).• The paper path may need cleaning. Clean the inside of your machine (see "Cleaning the machine" on page 69). <p>If these steps do not correct the problem, contact a service representative.</p>

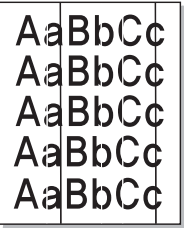
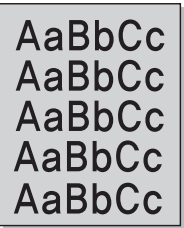
Printing quality problems

Condition	Suggested solutions
<p>Vertical lines</p> 	<p>If black vertical streaks appear on the page:</p> <ul style="list-style-type: none">• The surface (drum part) of the toner cartridge inside the machine has probably been scratched. Remove the toner cartridge and install a new one (see "Replacing the toner cartridge" on page 66). <p>If white vertical streaks appear on the page:</p> <ul style="list-style-type: none">• The surface of the LSU part inside the machine may be dirty. Clean the inside of your machine (see "Cleaning the machine" on page 69). If these steps do not correct the problem, contact a service representative.
<p>Black or color background</p> 	<p>If the amount of background shading becomes unacceptable:</p> <ul style="list-style-type: none">• Change to a lighter weight paper.• Check the environmental conditions: very dry conditions or a high level of humidity (higher than 80% RH) can increase the amount of background shading.• Remove the old toner cartridge and install a new one (see "Replacing the toner cartridge" on page 66).• Thoroughly redistribute the toner (see "Redistributing toner" on page 65).
<p>Toner smear</p> 	<ul style="list-style-type: none">• Clean the inside of the machine (see "Cleaning the machine" on page 69).• Check the paper type and quality.• Remove the toner cartridge and install a new one (see "Replacing the toner cartridge" on page 66).

Printing quality problems

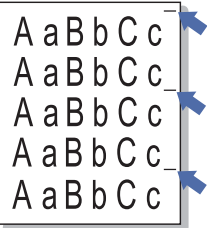
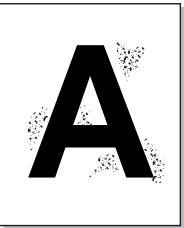
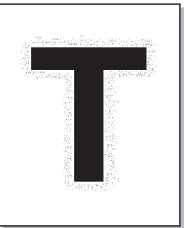
Condition	Suggested solutions
<p data-bbox="51 272 405 304">Vertical repetitive defects</p> 	<p data-bbox="506 272 1473 304">If marks repeatedly appear on the printed side of the page at even intervals:</p> <ul data-bbox="506 328 2190 544" style="list-style-type: none"><li data-bbox="506 328 2190 400">• The toner cartridge may be damaged. If you still have the same problem, remove the toner cartridge and, install a new one (see "Replacing the toner cartridge" on page 66).<li data-bbox="506 416 2190 488">• Parts of the machine may have toner on them. If the defects occur on the back of the page, the problem will likely correct itself after a few more pages.<li data-bbox="506 504 1464 544">• The fusing assembly may be damaged. Contact a service representative.
<p data-bbox="51 612 322 644">Background scatter</p> 	<p data-bbox="506 612 1621 644">Background scatter results from bits of toner randomly distributed on the printed page.</p> <ul data-bbox="506 668 2190 1059" style="list-style-type: none"><li data-bbox="506 668 2190 740">• The paper may be too damp. Try printing with a different batch of paper. Do not open packages of paper until necessary so that the paper does not absorb too much moisture.<li data-bbox="506 756 2190 876">• If background scatter occurs on an envelope, change the printing layout to avoid printing over areas that have overlapping seams on the reverse side. Printing on seams can cause problems. Or select Thick from the Printing Preferences window (see "Opening printing preferences" on page 47).<li data-bbox="506 892 2190 1011">• If background scatter covers the entire surface area of a printed page, adjust the print resolution through your software application or in Printing Preferences (see "Opening printing preferences" on page 47). Ensure the correct paper type is selected. For example: If Thicker Paper is selected, but Plain Paper actually used, an overcharging can occur causing this copy quality problem.<li data-bbox="506 1027 1872 1059">• If you are using a new toner cartridge, redistribute the toner first (see "Redistributing toner" on page 65).
<p data-bbox="51 1091 479 1163">Toner particles are around bold characters or pictures</p> 	<p data-bbox="506 1091 1249 1123">The toner might not adhere properly to this type of paper.</p> <ul data-bbox="506 1147 2190 1315" style="list-style-type: none"><li data-bbox="506 1147 2190 1219">• Change the printer option and try again. Go to Printing Preferences, click the Paper tab, and set the paper type to Recycled (see "Opening printing preferences" on page 47).<li data-bbox="506 1235 2190 1315">• Ensure the correct paper type is selected. For example: If Thicker Paper is selected, but Plain Paper actually used, an overcharging can occur causing this copy quality problem.

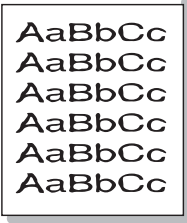
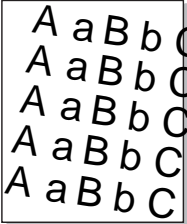
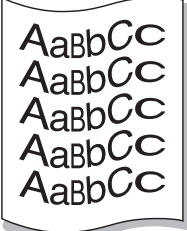

Printing quality problems

Condition	Suggested solutions
<p data-bbox="49 272 353 304">Misformed characters</p> 	<ul data-bbox="504 272 2072 304" style="list-style-type: none">• If characters are improperly formed and producing hollow images, the paper stock may be too slick. Try different paper.
<p data-bbox="49 608 203 639">Page skew</p> 	<ul data-bbox="504 608 1518 743" style="list-style-type: none">• Ensure that the paper is loaded properly.• Check the paper type and quality.• Ensure that the guides are not too tight or too loose against the paper stack.
<p data-bbox="49 951 226 983">Curl or wave</p> 	<ul data-bbox="504 951 1729 1086" style="list-style-type: none">• Ensure that the paper is loaded properly.• Check the paper type and quality. Both high temperature and humidity can cause paper curl.• Turn the stack of paper over in the tray. Also try rotating the paper 180° in the tray.

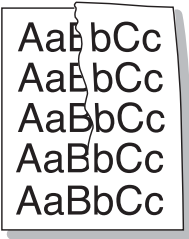
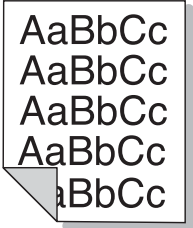
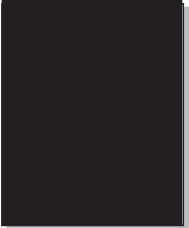
Printing quality problems

Condition	Suggested solutions
<p data-bbox="49 272 318 300">Wrinkles or creases</p> 	<ul data-bbox="504 272 1594 411" style="list-style-type: none">• Ensure that the paper is loaded properly.• Check the paper type and quality.• Turn the stack of paper over in the tray. Also try rotating the paper 180° in the tray.
<p data-bbox="49 619 412 646">Back of printouts are dirty</p> 	<ul data-bbox="504 619 1787 646" style="list-style-type: none">• Check for leaking toner. Clean the inside of the machine (see "Cleaning the machine" on page 69).
<p data-bbox="49 986 405 1013">Solid color or black pages</p> 	<ul data-bbox="504 986 2161 1161" style="list-style-type: none">• The toner cartridge may not be installed properly. Remove the cartridge and reinsert it.• The toner cartridge may be defective. Remove the toner cartridge and install a new one (see "Replacing the toner cartridge" on page 66).• The machine may require repairing. Contact a service representative.

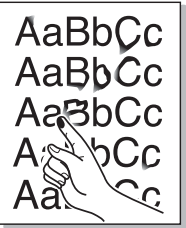
Printing quality problems

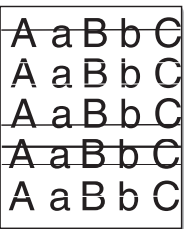
Condition	Suggested solutions
<p>Loose toner</p>  <p>AaBbCc AaBbCc AaBbCc AaBbCc AaBbCc</p>	<ul style="list-style-type: none">• Clean the inside of the machine (see "Cleaning the machine" on page 69).• Check the paper type and quality.• Remove the toner cartridge and then, install a new one (see "Replacing the toner cartridge" on page 66). <p>If the problem persists, the machine may require repair. Contact a service representative.</p>
<p>Character voids</p> 	<p>Character voids are white areas within parts of characters that should be solid black:</p> <ul style="list-style-type: none">• If you are using transparencies, try another type of transparency. Because of the composition of transparencies, some character voids are normal.• You may be printing on the wrong surface of the paper. Remove the paper and turn it around.• The paper may not meet paper specifications.
<p>Horizontal stripes</p>  <p>A a B b C A a B b C A a B b C A a B b C A a B b C</p>	<p>If horizontally aligned black streaks or smears appear:</p> <ul style="list-style-type: none">• The toner cartridge may be installed improperly. Remove the cartridge and reinsert it.• The toner cartridge may be defective. Remove the toner cartridge and install a new one (see "Replacing the toner cartridge" on page 66). <p>If the problem persists, the machine may require repairing. Contact a service representative.</p>

Printing quality problems

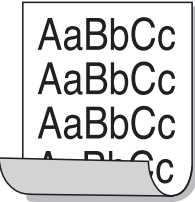
Condition	Suggested solutions
<p>Curl</p> 	<p>If the printed paper is curled or paper does not feed into the machine:</p> <ul style="list-style-type: none">• Turn the stack of paper over in the tray. Also try rotating the paper 180° in the tray.• Change the printer's paper option and try again. Go to Printing Preferences, click the Paper tab, and set type to Thin (see "Opening printing preferences" on page 47).
<ul style="list-style-type: none">• An unknown image repetitively appears on a few sheets• Loose toner• Light print or contamination occurs	<p>Your machine is probably being used at an altitude of 1,000 m (3,281 ft) or above.</p> <p>The high altitude may affect the print quality, such as loose toner or light imaging. Change the altitude setting for your machine (see "Altitude adjustment" on page 150).</p>

Copying problems

Condition	Suggested solutions
Copies are too light or too dark.	Adjust the darkness in copy feature to lighten or darken the backgrounds of copies (see "Changing the settings for each copy" on page 51).
If the defect still appears after cleaning the machine.	set the Copy Feature > Adjust Background > Auto . (see "Menu overview" on page 25).
Smears, lines, marks, or spots appear on copies.	<ul style="list-style-type: none">• If the defects are on the original, adjust darkness in copy feature to lighten the background of your copies.• If there are no defects on the original, clean the scan unit (see "Cleaning the scan unit" on page 72).
Copy image is skewed.	<ul style="list-style-type: none">• Ensure that the original is aligned with the registration guide.• The transfer roller may be dirty. Clean the inside of your machine (see "Cleaning the machine" on page 69).
Blank copies print out.	Ensure that the original is face down on the scanner glass or face up in the document feeder. If these steps do not correct the problem, contact a service representative.
Image rubs off the copy easily.	<ul style="list-style-type: none">• Replace the paper in the tray with paper from a new package.• In high humidity areas, do not leave paper in the machine for extended periods of time.
Frequent copy paper jams occur.	<ul style="list-style-type: none">• Fan the paper, then turn it over in the tray. Replace the paper in the tray with a fresh supply. Check/adjust the paper guides, if necessary.• Ensure that the paper is the proper type and weight (see "Print media specifications" on page 94).• Check for copy paper or pieces of copy paper remaining in the machine after a paper jam has been cleared.
Toner cartridge produces fewer copies than expected before running out of toner.	<ul style="list-style-type: none">• Your originals may contain pictures, solids, or heavy lines. For example, your originals may be forms, newsletters, books, or other documents that use more toner.• The scanner lid may be left open while copies are being made.• Turn the machine off and back on.

Scanning problems

Condition	Suggested solutions
The scanner does not work.	<ul style="list-style-type: none">• Make sure that you place the original to be scanned face down on the scanner glass, or face up in the document feeder (see "Loading originals" on page 42).• There may not be enough available memory to hold the document you want to scan. Try the Prescan function to see if that works. Try lowering the scan resolution rate.• Check that the machine printer cable is connected properly.• Make sure that the machine printer cable is not defective. Switch the printer cable with a known good cable. If necessary, replace the printer cable.• Check that the scanner is configured correctly. Check scan setting in the SmarThru Office or the application you want to use to make certain that the scanner job is being sent to the correct port (for example, USB001).
The unit scans very slowly.	<ul style="list-style-type: none">• Check if the machine is printing received data. If so, scan the document after the received data has been printed.• Graphics are scanned more slowly than text.• Communication speed slows in scan mode because of the large amount of memory required to analyze and reproduce the scanned image. Set your computer to the ECP printer mode through BIOS setting. It will help to increase the speed. For details about how to set BIOS, refer to your computer user's guide.

Scanning problems

Condition	Suggested solutions
<p>Message appears on your computer screen:</p> <ul style="list-style-type: none">• Device can't be set to the H/W mode you want.• Port is being used by another program.• Port is disabled.• Scanner is busy receiving or printing data. When the current job is completed, try again.• Invalid handle.• Scanning has failed.	<ul style="list-style-type: none">• There may be a copying or printing job in progress. Try your job again when that job is finished.• The selected port is currently being used. Restart your computer and try again.• The machine printer cable may be improperly connected or the power may be off.• The scanner driver is not installed or the operating environment is not set up properly.• Ensure that the machine is properly connected and the power is on, then restart your computer.• The USB cable may be improperly connected or the power may be off.

Faxing problems

Condition	Suggested solutions
The machine is not working, there is no display, or the buttons are not working.	<ul style="list-style-type: none">• Unplug the power cord and plug it in again.• Ensure that there is power being supplied to the electrical outlet.• Ensure that the power is turned on.
No dial tone.	<ul style="list-style-type: none">• Check that the phone line is properly connected (see "Rear view" on page 17).• Check that the phone socket on the wall is working by plugging in another phone.
The numbers stored in memory do not dial correctly.	Make sure that the numbers are stored in memory correctly. To check that, print an address book list.
The original does not feed into the machine.	<ul style="list-style-type: none">• Make sure that the paper is not wrinkled and you are inserting it in correctly. Check that the original is the right size, not too thick or thin.• Make sure that the document feeder is firmly closed.• The document feeder rubber pad may need to be replaced. Contact a service representative.
Faxes are not received automatically.	<ul style="list-style-type: none">• The receiving mode should be set to fax (see "Changing the receive modes" on page 179).• Make sure that there is paper in the tray (see "Print media specifications" on page 94).• Check to see if the display shows any error message. If it does, clear the problem.
The machine does not send.	<ul style="list-style-type: none">• Make sure that the original is loaded in the document feeder or on the scanner glass.• Check the fax machine you are sending to, to see if it can receive your fax.
The incoming fax has blank spaces or is of poor-quality.	<ul style="list-style-type: none">• The fax machine sending you the fax may be faulty.• A noisy phone line can cause line errors.• Check your machine by making a copy.• A toner cartridge has almost reached its estimated cartridge life. Replace the toner cartridge (see "Replacing the toner cartridge" on page 66).

Faxing problems

Condition	Suggested solutions
Some of the words on an incoming fax are stretched.	The fax machine sending the fax had a temporary document jam.
There are lines on the originals you sent.	Check your scan unit for marks and clean it (see "Cleaning the scan unit" on page 72).
The machine dials a number, but the connection with the other fax machine fails.	The other fax machine may be turned off, out of paper, or cannot answer incoming calls. Speak with the other machine operator and ask them to solve the problem on their side.
Faxes do not store in memory.	There may not be enough memory space to store the fax. If the display indicating the memory status shows, delete any faxes you no longer need from the memory, and then try to store the fax again. Call for service.
Blank areas appear at the bottom of each page or on other pages, with a small strip of text at the top.	You may have chosen the wrong paper settings in the user option setting. Check the paper size and type again.

Operating system problems

Common Windows problems

Condition	Suggested solutions
“File in Use” message appears during installation.	Exit all software applications. Remove all software from the startup group, then restart Windows. Reinstall the printer driver.
“General Protection Fault”, “Exception OE”, “Spool 32”, or “Illegal Operation” messages appear.	Close all other applications, reboot Windows and try printing again.
“Fail To Print”, “A printer timeout error occurred” message appear.	These messages may appear during printing. Just keep waiting until the machine finishes printing. If the message appears in ready mode or after printing has completed, check the connection and/or whether an error has occurred.



Refer to the Microsoft Windows User's Guide that came with your computer for further information on Windows error messages.

Operating system problems

Common Macintosh problems

Condition	Suggested solutions
The machine does not print PDF files correctly. Some parts of graphics, text, or illustrations are missing.	<p>Printing the PDF file as an image may enable the file to print. Turn on Print As Image from the Acrobat printing options.</p> <p> It will take longer to print when you print a PDF file as an image.</p>
Some letters are not displayed normally during cover page printing.	<p>Mac OS cannot create the font while printing the cover page. The English alphabet and numbers are displayed normally on the cover page.</p>
When printing a document in Macintosh with Acrobat Reader 6.0 or higher, colors print incorrectly.	<p>Make sure that the resolution setting in your machine driver matches the one in Acrobat Reader.</p>



Refer to the Macintosh User's Guide that came with your computer for further information on Macintosh error messages.

Operating system problems

Common Linux problems

Condition	Suggested solutions
The machine does not print.	<ul style="list-style-type: none">• Check if the printer driver is installed in your system. Open Unified Driver Configurator and switch to the Printers tab in the Printers configuration window to look at the list of available machines. Make sure that your machine is displayed on the list. If not, open Add new printer wizard to set up your device.• Check if the machine is started. Open Printers configuration and select your machine from the printers list. Look at the description in the Selected printer pane. If its status contains Stopped, press the Start button. Normal operation of the machine should be restored. The “stopped” status might be activated when some problems in printing occur.• Check if your application has special print options such as “-oraw”. If “-oraw” is specified in the command line parameter, then remove it to print properly. For Gimp front-end, select “print” -> “Setup printer” and edit the command line parameter in the command item.
Some color images come out all black.	<p>This is a known bug in Ghostscript (until GNU Ghostscript version 7.05) when the base color space of the document is indexed color space and it is converted through CIE color space. Because Postscript uses CIE color space for Color Matching System, you should upgrade Ghostscript on your system to at least GNU Ghostscript version 7.06 or later. You can find recent Ghostscript versions at www.ghostscript.com.</p>
Some color images come out in unexpected color.	<p>This is a known bug in Ghostscript (until GNU Ghostscript version 7.xx) when the base color space of the document is indexed RGB color space and it is converted through CIE color space. Because Postscript uses CIE color space for Color Matching System, you should upgrade Ghostscript on your system to at least GNU Ghostscript version 8.xx or later. You can find recent Ghostscript versions at www.ghostscript.com.</p>
The machine does not print whole pages, and output is printed on half the page.	<p>It is a known problem that occurs when a color machine is used on version 8.51 or earlier of Ghostscript, 64-bit Linux OS, and has been reported to bugs.ghostscript.com as Ghostscript Bug 688252. The problem is solved in AFPL Ghostscript v. 8.52 or above. Download the latest version of AFPL Ghostscript from http://sourceforge.net/projects/ghostscript/ and install it to solve this problem.</p>

Operating system problems

Condition	Suggested solutions
I cannot scan via Gimp Front-end.	<p>Check if Gimp Front-end has Xsane:Device dialog. on the Acquire menu. If not, you should install Xsane plug-in for Gimp on the your computer. You can find Xsane plug-in package for Gimp on Linux distribution CD or Gimp home page. For the detailed information, refer to the Help for Linux distribution CD or Gimp Front-end application.</p> <p>If you wish to use another kind of scan application, refer to application's Help.</p>
"Cannot open port device file" error message appears when printing a document.	<p>Avoid changing print job parameters (e.g., via LPR GUI) while a print job is in progress. Known versions of CUPS server break the print job whenever print options are changed and then try to restart the job from the beginning. Since Unified Linux Driver locks the port while printing, the abrupt termination of the driver keeps the port locked and unavailable for subsequent print jobs. If this situation occurs, try to release the port by selecting Release port in the Port configuration window.</p>
The machine does not appear on the scanners list.	<ul style="list-style-type: none">• Ensure your machine is attached to your computer, connected properly via the USB port, and is turned on.• Ensure the scanner driver for your machine is installed in your system. Open Unified Linux Driver configurator, switch to Scanners configuration, then press Drivers. Make sure that driver with a name corresponding to your machine's name is listed in the window.• Ensure the port is not busy. Since functional components of machine (printer and scanner) share the same I/O interface (port), the situation of simultaneous access of different user applications to the same port is possible. To avoid possible conflicts, only one of them at a time is allowed to gain control over the device. The other user will encounter "device busy" response. This usually happens when starting a scan procedure. An appropriate message box appears. <p>To identify the source of the problem, open the Ports configuration and select the port assigned to your scanner, port's symbol /dev/mfp0 corresponds to LP:0 designation displayed in the scanners' options, /dev/mfp1 relates to LP:1, and so on. USB ports start at /dev/mfp4, so scanner on USB:0 relates to /dev/mfp4 respectively and so forth sequentially. In the Selected port pane, you can see if the port is occupied by another application. If this is the case, you should either wait for completion of the current job or press the Release port button, if you are sure that the present port application is not functioning properly.</p>
The machine does not scan.	<ul style="list-style-type: none">• Ensure a document is loaded into the machine, ensure your machine is connected to the computer.• If there is an I/O error while scanning.



Refer to the Linux User's Guide that came with your computer for further information on Linux error messages.



The following glossary helps you get familiar with the product by understanding the terminologies commonly used with printing as well as mentioned in this user's guide.

802.11

802.11 is a set of standards for wireless local area network (WLAN) communication, developed by the IEEE LAN/MAN Standards Committee (IEEE 802).

802.11b/g/n

802.11b/g/n can share same hardware and use the 2.4 GHz band. 802.11b supports bandwidth up to 11 Mbps, 802.11n supports bandwidth up to 150 Mbps. 802.11b/g/n devices may occasionally suffer interference from microwave ovens, cordless telephones, and Bluetooth devices.

Access point

Access Point or Wireless Access Point (AP or WAP) is a device that connects wireless communication devices together on wireless local area networks (WLAN), and acts as a central transmitter and receiver of WLAN radio signals.

ADF

An Automatic Document Feeder (ADF) is a scanning unit that will automatically feed an original sheet of paper so that the machine can scan some amount of the paper at once.

AppleTalk

AppleTalk is a proprietary suite of protocols developed by Apple, Inc for computer networking. It was included in the original Macintosh (1984) and is now deprecated by Apple in favor of TCP/IP networking.

BIT Depth

A computer graphics term describing the number of bits used to represent the color of a single pixel in a bitmapped image. Higher color depth gives a broader range of distinct colors. As the number of bits increases, the number of possible colors becomes impractically large for a color map. 1-bit color is commonly called as monochrome or black and white.

BMP

A bitmapped graphics format used internally by the Microsoft Windows graphics subsystem (GDI), and used commonly as a simple graphics file format on that platform.

BOOTP

Bootstrap Protocol. A network protocol used by a network client to obtain its IP address automatically. This is usually done in the bootstrap process of computers or operating systems running on them. The BOOTP servers assign the IP address from a pool of addresses to each client. BOOTP enables 'diskless workstation' computers to obtain an IP address prior to loading any advanced operating system.

CCD

Charge Coupled Device (CCD) is a hardware which enables the scan job. CCD Locking mechanism is also used to hold the CCD module to prevent any damage when you move the machine.

Collation

Collation is a process of printing a multiple-copy job in sets. When collation is selected, the device prints an entire set before printing additional copies.

Control Panel

A control panel is a flat, typically vertical, area where control or monitoring instruments are displayed. They are typically found in front of the machine.

Coverage

It is the printing term used for a toner usage measurement on printing. For example, 5% coverage means that an A4 sided paper has about 5% image or text on it. So, if the paper or original has complicated images or lots of text on it, the coverage will be higher and at the same time, a toner usage will be as much as the coverage.

CSV

Comma Separated Values (CSV). A type of file format, CSV is used to exchange data between disparate applications. The file format, as it is used in Microsoft Excel, has become a de facto standard throughout the industry, even among non-Microsoft platforms.

DADF

A Duplex Automatic Document Feeder (DADF) is a scanning unit that will automatically feed and turn over an original sheet of paper so that the machine can scan on both sides of the paper.

Default

The value or setting that is in effect when taking a printer out of its box state, reset, or initialized.

DHCP

A Dynamic Host Configuration Protocol (DHCP) is a client-server networking protocol. A DHCP server provides configuration parameters specific to the DHCP client host requesting, generally, information required by the client host to participate on an IP network. DHCP also provides a mechanism for allocation of IP addresses to client hosts.

DIMM

Dual Inline Memory Module (DIMM), a small circuit board that holds memory. DIMM stores all the data within the machine like printing data, received fax data.

DLNA

The Digital Living Network Alliance (DLNA) is a standard that allows devices on a home network to share information with each other across the network.

DNS

The Domain Name Server (DNS) is a system that stores information associated with domain names in a distributed database on networks, such as the Internet.

Dot Matrix Printer

A dot matrix printer refers to a type of computer printer with a print head that runs back and forth on the page and prints by impact, striking an ink-soaked cloth ribbon against the paper, much like a typewriter.

DPI

Dots Per Inch (DPI) is a measurement of resolution that is used for scanning and printing. Generally, higher DPI results in a higher resolution, more visible detail in the image, and a larger file size.

DRPD

Distinctive Ring Pattern Detection. Distinctive Ring is a telephone company service which enables a user to use a single telephone line to answer several different telephone numbers.

Duplex

A mechanism that will automatically turn over a sheet of paper so that the machine can print (or scan) on both sides of the paper. A printer equipped with a Duplex Unit can print on both sides of paper during one print cycle.

Duty Cycle

Duty cycle is the page quantity which does not affect printer performance for a month. Generally the printer has the lifespan limitation such as pages per year. The lifespan means the average capacity of print-outs, usually within the warranty period. For example, if the duty cycle is 48,000 pages per month assuming 20 working days, a printer limits 2,400 pages a day.

ECM

Error Correction Mode (ECM) is an optional transmission mode built into Class 1 fax machines or fax modems. It automatically detects and corrects errors in the fax transmission process that are sometimes caused by telephone line noise.

Emulation

Emulation is a technique of one machine obtaining the same results as another.

An emulator duplicates the functions of one system with a different system, so that the second system behaves like the first system. Emulation focuses on exact reproduction of external behavior, which is in contrast to simulation, which concerns an abstract model of the system being simulated, often considering its internal state.

Ethernet

Ethernet is a frame-based computer networking technology for local area networks (LANs). It defines wiring and signaling for the physical layer, and frame formats and protocols for the media access control (MAC)/data link layer of the OSI model. Ethernet is mostly standardized as IEEE 802.3. It has become the most widespread LAN technology in use during the 1990s to the present.

EtherTalk

A suite of protocols developed by Apple Computer for computer networking. It was included in the original Macintosh (1984) and is now deprecated by Apple in favor of TCP/IP networking.

FDI

Foreign Device Interface (FDI) is a card installed inside the machine to allow a third party device such as a coin operated device or a card reader. Those devices allow the pay-for-print service on your machine.

FTP

A File Transfer Protocol (FTP) is a commonly used protocol for exchanging files over any network that supports the TCP/IP protocol (such as the Internet or an intranet).

Fuser Unit

The part of a laser printer that fuses the toner onto the print media. It consists of a heat roller and a pressure roller. After toner is transferred onto the paper, the fuser unit applies heat and pressure to ensure that the toner stays on the paper permanently, which is why paper is warm when it comes out of a laser printer.

Gateway

A connection between computer networks, or between a computer network and a telephone line. It is very popular, as it is a computer or a network that allows access to another computer or network.

Grayscale

A shades of gray that represent light and dark portions of an image when color images are converted to grayscale; colors are represented by various shades of gray.

Halftone

An image type that simulates grayscale by varying the number of dots. Highly colored areas consist of a large number of dots, while lighter areas consist of a smaller number of dots.

Mass storage device (HDD)

Mass storage device (HDD), commonly referred to as a hard drive or hard disk, is a non-volatile storage device which stores digitally-encoded data on rapidly rotating platters with magnetic surfaces.

IEEE

The Institute of Electrical and Electronics Engineers (IEEE) is an international non-profit, professional organization for the advancement of technology related to electricity.

IEEE 1284

The 1284 parallel port standard was developed by the Institute of Electrical and Electronics Engineers (IEEE). The term "1284-B" refers to a specific connector type on the end of the parallel cable that attaches to the peripheral (for example, a printer).

Intranet

A private network that uses Internet Protocols, network connectivity, and possibly the public telecommunication system to securely share part of an organization's information or operations with its employees. Sometimes the term refers only to the most visible service, the internal website.

IP address

An Internet Protocol (IP) address is a unique number that devices use in order to identify and communicate with each other on a network utilizing the Internet Protocol standard.

IPM

The Images Per Minute (IPM) is a way of measuring the speed of a printer. An IPM rate indicates the number of single-sided sheets a printer can complete within one minute.

IPP

The Internet Printing Protocol (IPP) defines a standard protocol for printing as well as managing print jobs, media size, resolution, and so forth. IPP can be used locally or over the Internet to hundreds of printers, and also supports access control, authentication, and encryption, making it a much more capable and secure printing solution than older ones.

IPX/SPX

IPX/SPX stands for Internet Packet Exchange/Sequenced Packet Exchange. It is a networking protocol used by the Novell NetWare operating systems. IPX and SPX both provide connection services similar to TCP/IP, with the IPX protocol having similarities to IP, and SPX having similarities to TCP. IPX/SPX was primarily designed for local area networks (LANs), and is a very efficient protocol for this purpose (typically its performance exceeds that of TCP/IP on a LAN).

ISO

The International Organization for Standardization (ISO) is an international standard-setting body composed of representatives from national standards bodies. It produces world-wide industrial and commercial standards.

ITU-T

The International Telecommunication Union is an international organization established to standardize and regulate international radio and telecommunications. Its main tasks include standardization, allocation of the radio spectrum, and organizing interconnection arrangements between different countries to allow international phone calls. A -T out of ITU-T indicates telecommunication.

ITU-T No. 1 chart

Standardized test chart published by ITU-T for document facsimile transmissions.

JBIG

Joint Bi-level Image Experts Group (JBIG) is an image compression standard with no loss of accuracy or quality, which was designed for compression of binary images, particularly for faxes, but can also be used on other images.

JPEG

Joint Photographic Experts Group (JPEG) is a most commonly used standard method of lossy compression for photographic images. It is the format used for storing and transmitting photographs on the World Wide Web.

LDAP

The Lightweight Directory Access Protocol (LDAP) is a networking protocol for querying and modifying directory services running over TCP/IP.

LED

A Light-Emitting Diode (LED) is a semiconductor device that indicates the status of a machine.

MAC address

Media Access Control (MAC) address is a unique identifier associated with a network adapter. MAC address is a unique 48-bit identifier usually written as 12 hexadecimal characters grouped in pairs (e. g., 00-00-0c-34-11-4e). This address is usually hard-coded into a Network Interface Card (NIC) by its manufacturer, and used as an aid for routers trying to locate machines on large networks.

MFP

Multi Function Peripheral (MFP) is an office machine that includes the following functionality in one physical body, so as to have a printer, a copier, a fax, a scanner and etc.

MH

Modified Huffman (MH) is a compression method for decreasing the amount of data that needs to be transmitted between the fax machines to transfer the image recommended by ITU-T T.4. MH is a codebook-based run-length encoding scheme optimized to efficiently compress white space. As most faxes consist mostly of white space, this minimizes the transmission time of most faxes.

MMR

Modified Modified READ (MMR) is a compression method recommended by ITU-T T.6.

Modem

A device that modulates a carrier signal to encode digital information, and also demodulates such a carrier signal to decode transmitted information.

MR

Modified Read (MR) is a compression method recommended by ITU-T T.4. MR encodes the first scanned line using MH. The next line is compared to the first, the differences determined, and then the differences are encoded and transmitted.

Glossary

NetWare

A network operating system developed by Novell, Inc. It initially used cooperative multitasking to run various services on a PC, and the network protocols were based on the archetypal Xerox XNS stack. Today NetWare supports TCP/IP as well as IPX/SPX.

OPC

Organic Photo Conductor (OPC) is a mechanism that makes a virtual image for print using a laser beam emitted from a laser printer, and it is usually green or rust colored and has a cylinder shape.

An imaging unit containing a drum slowly wears the drum surface by its usage in the printer, and it should be replaced appropriately since it gets worn from contact with the cartridge development brush, cleaning mechanism, and paper.

Originals

The first example of something, such as a document, photograph or text, etc, which is copied, reproduced or translated to produce others, but which is not itself copied or derived from something else.

OSI

Open Systems Interconnection (OSI) is a model developed by the International Organization for Standardization (ISO) for communications. OSI offers a standard, modular approach to network design that divides the required set of complex functions into manageable, self-contained, functional layers. The layers are, from top to bottom, Application, Presentation, Session, Transport, Network, Data Link and Physical.

PABX

A private automatic branch exchange (PABX) is an automatic telephone switching system within a private enterprise.

PCL

Printer Command Language (PCL) is a Page Description Language (PDL) developed by HP as a printer protocol and has become an industry standard. Originally developed for early inkjet printers, PCL has been released in varying levels for thermal, dot matrix printer, and laser printers.

PDF

Portable Document Format (PDF) is a proprietary file format developed by Adobe Systems for representing two dimensional documents in a device independent and resolution independent format.

PostScript

PostScript (PS) is a page description language and programming language used primarily in the electronic and desktop publishing areas. - that is run in an interpreter to generate an image.

Printer Driver

A program used to send commands and transfer data from the computer to the printer.

Print Media

The media like paper, envelopes, labels, and transparencies which can be used in a printer, a scanner, a fax or, a copier.

PPM

Pages Per Minute (PPM) is a method of measurement for determining how fast a printer works, meaning the number of pages a printer can produce in one minute.

PRN file

An interface for a device driver, this allows software to interact with the device driver using standard input/output system calls, which simplifies many tasks.

Protocol

A convention or standard that controls or enables the connection, communication, and data transfer between two computing endpoints.

PS

See PostScript.

PSTN

The Public-Switched Telephone Network (PSTN) is the network of the world's public circuit-switched telephone networks which, on industrial premises, is usually routed through the switchboard.

RADIUS

Remote Authentication Dial In User Service (RADIUS) is a protocol for remote user authentication and accounting. RADIUS enables centralized management of authentication data such as usernames and passwords using an AAA (authentication, authorization, and accounting) concept to manage network access.

Resolution

The sharpness of an image, measured in Dots Per Inch (DPI). The higher the dpi, the greater the resolution.

SMB

Server Message Block (SMB) is a network protocol mainly applied to share files, printers, serial ports, and miscellaneous communications between nodes on a network. It also provides an authenticated Inter-process communication mechanism.

SMTP

Simple Mail Transfer Protocol (SMTP) is the standard for e-mail transmissions across the Internet. SMTP is a relatively simple, text-based protocol, where one or more recipients of a message are specified, and then the message text is transferred. It is a client-server protocol, where the client transmits an email message to the server.

SSID

Service Set Identifier (SSID) is a name of a wireless local area network (WLAN). All wireless devices in a WLAN use the same SSID in order to communicate with each other. The SSIDs are case-sensitive and have a maximum length of 32 characters.

Subnet Mask

The subnet mask is used in conjunction with the network address to determine which part of the address is the network address and which part is the host address.

TCP/IP

The Transmission Control Protocol (TCP) and the Internet Protocol (IP); the set of communications protocols that implement the protocol stack on which the Internet and most commercial networks run.

TCR

Transmission Confirmation Report (TCR) provides details of each transmission such as job status, transmission result and number of pages sent. This report can be set to print after each job or only after failed transmissions.

TIFF

Tagged Image File Format (TIFF) is a variable-resolution bitmapped image format. TIFF describes image data that typically come from scanners. TIFF images make use of tags, keywords defining the characteristics of the image that is included in the file. This flexible and platform-independent format can be used for pictures that have been made by various image processing applications.

Toner Cartridge

A kind of bottle or container used in a machine like a printer which contains toner. Toner is a powder used in laser printers and photocopiers, which forms the text and images on the printed paper. Toner can be fused by by a combination of heat/pressure from the fuser, causing it to bind to the fibers in the paper.

TWAIN

An industry standard for scanners and software. By using a TWAIN-compliant scanner with a TWAIN-compliant program, a scan can be initiated from within the program. It is an image capture API for Microsoft Windows and Apple Macintosh operating systems.

UNC Path

Uniform Naming Convention (UNC) is a standard way to access network shares in Window NT and other Microsoft products. The format of a UNC path is:
\\<servername>\<sharename>\<Additional directory>

URL

Uniform Resource Locator (URL) is the global address of documents and resources on the Internet. The first part of the address indicates what protocol to use, the second part specifies the IP address or the domain name where the resource is located.

USB

Universal Serial Bus (USB) is a standard that was developed by the USB Implementers Forum, Inc., to connect computers and peripherals. Unlike the parallel port, USB is designed to concurrently connect a single computer USB port to multiple peripherals.

Watermark

A watermark is a recognizable image or pattern in paper that appears lighter when viewed by transmitted light. Watermarks were first introduced in Bologna, Italy in 1282; they have been used by papermakers to identify their product, and also on postage stamps, currency, and other government documents to discourage counterfeiting.

WEP

Wired Equivalent Privacy (WEP) is a security protocol specified in IEEE 802.11 to provide the same level of security as that of a wired LAN. WEP provides security by encrypting data over radio so that it is protected as it is transmitted from one end point to another.

WIA

Windows Imaging Architecture (WIA) is an imaging architecture that is originally introduced in Windows Me and Windows XP. A scan can be initiated from within these operating systems by using a WIA-compliant scanner.

WPA

Wi-Fi Protected Access (WPA) is a class of systems to secure wireless (Wi-Fi) computer networks, which was created to improve upon the security features of WEP.

WPA-PSK

WPA-PSK (WPA Pre-Shared Key) is special mode of WPA for small business or home users. A shared key, or password, is configured in the wireless access point (WAP) and any wireless laptop or desktop devices. WPA-PSK generates a unique key for each session between a wireless client and the associated WAP for more advanced security.

WPS

The Wi-Fi Protected Setup (WPS) is a standard for establishing a wireless home network. If your wireless access point supports WPS, you can configure the wireless network connection easily without a computer.

XPS

XML Paper Specification (XPS) is a specification for a Page Description Language (PDL) and a new document format, which has benefits for portable document and electronic document, developed by Microsoft. It is an XML-based specification, based on a new print path and a vector-based device-independent document format.

Index

A

address book	
editing	152
group editing	153
group registering	153
registering	152
using	152
address book setup	152
AirPrint	129

C

cleaning	
inside	69
outside	69
pickup roller	71
scan unit	72
cleaning a machine	69
control panel	18
convention	9
copy	
general setup	136
copy button	18
copying	

basic copying	51
reducing or enlarging copies	52

D

default settings	
tray setting	41
Dell Printer Status	191
driver installation	
Unix	123

E

eco printing	48
Embedded Web Service	186
entering character	151
error message	87

F

favorites settings, for printing	48
fax	
adding documents to a reserved fax	176
automatic redialing	174
canceling a reserved fax job	177
changing the receive modes	179
delaying a fax transmission	176

forwarding a received fax to another destination	178
forwarding a sent fax to another destination	177
general setup	140
printing faxes on both sides of the paper	182
Printing sent fax report automatically	182
receiving a fax in the computer	178
receiving faxes in memory	182
receiving in Answering Machine mode	180
receiving in DRPD mode	181
receiving in Fax mode	180
receiving in secure mode	181
receiving in Tel mode	180
receiving with ext. telephone	180
redialing the last number	174
sending a fax in the computer	175
sending a priority fax	177
fax feature	174
fax sending	
multi sending	57
faxing	
adjusting darkness	59
adjusting resolution	58

Index

preparing to fax	56
receiving in Fax mode	58
features	5
machine features	133
print media feature	94
firmware update utility	184
front view	16

G

general icons	9
general settings	143
glossary	220
google cloud printing	130

I

id copy	53
ID copy button	18

J

jam	
clearing original document	76
clearing paper	80
tips for avoiding paper jams	75

L

LCD display	
browsing the machine status	136, 139, 140, 146
Linux	
common Linux problems	218
driver installation for network connected	122
driver installation for USB cable connected	113
driver reinstallation for USB cable connected	114
printer properties	164
printing	163
scanning	172
system requirements	100
unified driver configurator	193
using SetIP	119
linux scanning	172
loading	
paper in manual feeder/multi-purpose tray	34
paper in the tray1	33
special media	36
loading originals	42

M

machine information	136, 139, 140, 146
machine setup	
machine status	136, 139, 140, 146
Macintosh	
common Macintosh problems	217
driver installation for network connected	121
driver installation for USB cable connected	110
driver reinstallation for USB cable connected	112
printing	161
scanning	171
system requirements	98
using SetIP	118
macintosh scanning	171
manual feeder/multi-purpose tray	
loading	34
menu overview	25
multi-purpose tray	
tips on using	34
using special media	36

Index

N

network	
driver installation	
Linux	122
Macintosh	121
UNIX	123
Windows	120
general setup	148
installing environment	101
introducing network programs	116
IPv6 configuration	126
SetIP program	117, 118, 119
wired network setup	117
n-up printing	
Macintosh	162
O	
on hook dial button	19
optional tray	
loading paper	33
overlay printing	
create	160
delete	161
print	161

P

placing a machine	
adjusting the altitude	150
preparing originals type	41
print	
general setup	135
print media	
card stock	40
envelope	37
labels	39
output support	94
preprinted paper	40
setting the paper size	41
setting the paper type	41
special media	36
transparency	38
print menu	135
print resolution set	
Linux	163
printer preferences	
Linux	164
Printing	45
printing	

changing the default print settings	155
Linux	163
Macintosh	161
multiple pages on one sheet of paper	
Macintosh	162
printing a document	
Windows	45
printing to a file	156
setting as a default machine	155
UNIX	165
printing a document	
Linux	163
Macintosh	161
UNIX	165
printing feature	155
problem	
operating system problems	216
problems	
copying problems	211
faxing problems	214
paper feeding problems	198
power problems	199
printing problems	200
printing quality problems	203

Index

scanning problems	212	Scanning from network connected machine	168	replacing the cartridge	66
				storing	63
R		Scanning using the WIA driver	169	tray	
rear view	17	Scanning with SmarThru Office	170	adjusting the width and length	31
redial/pause button	18	SetIP program	117	changing the tray size	31
reports		SmarThru Office	170	loading paper in manual	
machine information	136, 140, 141, 142, 143, 146	Special features	149	feeder/multi-purpose tray	34
resolution		specifications	92	setting the paper size and type	41
faxing	58	print media	94		
S		status	19	U	
safety		supplies		understanding the status LED	85
information	10	available supplies	62	UNIX	
symbols	10	estimated toner cartridge life	64	driver installation for network connected	
Scan Assitant	169	monitoring the supplies life	67	123	
scan feature	167	ordering	62	printing	165
Scanning		replacing toner cartridge	66	Unix	
Scanning with Dell Scan Assitant	169	Supplies Ordering Utility	185	system requirements	99
scanning		T		USB cable	
basic information	167	toner cartridge		driver installation	21, 23, 110, 113
Linux scanning	172	estimated life	64	driver reinstallation	112, 114
Macintosh scanning	171	handling instructions	63	using help	48, 162
Scanning from image editing program	168	non-Dell and refilled	63	W	
		redistributing toner	65	watermark	
				create	159

delete	159
edit	159

Windows

common Windows problems	216
driver installation for network connected	
120	
driver installation for USB cable connected	
21,	23
system requirements	97
using SetIP	117