

# Coronis Fusion 4MP/6MP

User Guide



**BARCO**

Visibly yours

(This page intentionally left blank.)

# Welcome!

Thank you for choosing this CORONIS FUSION 4MP/6MP display!







Coronis Fusion is an ingenious PACS display system designed to further enhance flexibility and productivity in diagnostic imaging.

Featuring the industry's first 30-inch color LCD that can be used as two seamless heads or one wide-screen display, Coronis Fusion offers you the freedom to organize your workspace just the way you want it. It allows you to read CT, MR, cath and echo cardiogram images, or any other combination, side by side on a single diagnostic screen.

Coronis Fusion features the latest, breakthrough In-Plane Switching (IPS-Pro) LCD technology. This technology brings the most advanced LCD viewing characteristics on the market, setting new standards for brightness and contrast, even from a wide viewing angle.

Use the instructions in this guide to install your CORONIS FUSION 4MP/6MP display and discover all these interesting features yourself!

Following symbols may be used throughout this guide:

	Warning: Risk of injury to human beings		Caution: Risk of damage to the product
	Important notice or remark		Note
	Hint, tip		Additional information



Read all the safety information starting on page 51 before operating your CORONIS FUSION 4MP/6MP display.

(This page intentionally left blank.)

# Table of contents

<b>What's in the box.....</b>	<b>6</b>
<b>Parts, controls and connectors .....</b>	<b>7</b>
Front view .....	7
Rear view .....	8
<b>Display installation .....</b>	<b>11</b>
Removing the covers .....	11
Unlocking the height mechanism .....	13
Adjusting the display position .....	14
Connecting the signal cables.....	15
Connecting the power cables.....	16
Routing the cables.....	16
Re-attaching the covers .....	17
VESA-mount installation.....	18
First time starting up .....	20
<b>Daily operation .....</b>	<b>21</b>
Recommendations for daily operation .....	21
Stand-by switching .....	23
Bringing up the OSD menu.....	23
Navigating through the OSD menus.....	24
Making selections in the OSD menus.....	25
Changing values in the OSD menus .....	25
<b>Advanced operation .....</b>	<b>26</b>
Info messages.....	26
On-screen display (OSD).....	28
Luminance and color menu .....	28
Display Function menu.....	30
Settings menu .....	35

Information menu.....	37
Changing the viewing mode.....	38
Enabling/disabling User Controls.....	38
Switching Power LED on/off.....	40
Switching DPMS on/off.....	40
Changing Display Functions.....	41
Concepts.....	41
Display function selection.....	42
ALC & DICOM Options.....	43
<b>Cleaning your display .....</b>	<b>48</b>
Front glass.....	48
Cabinet.....	49
<b>Important information .....</b>	<b>50</b>
Safety information.....	50
Environmental information.....	53
Regulatory compliance information.....	56
Explanation of symbols.....	57
Legal disclaimer.....	59
Technical specifications.....	60
Warranty statement.....	66

# What's in the box

Your CORONIS FUSION 4MP/6MP display comes with:

- this CORONIS FUSION 4MP/6MP display guide
- a system CD
- two DVI cables
- a USB cable
- a set of AC power cords
- an external power supply

If you ordered a Barco display controller, it's also in the box together with its accessories. A dedicated user guide is available on the system CD.



Keep your original packaging. It is designed for this display and is the ideal protection during transport.

# Parts, controls and connectors

## Front view

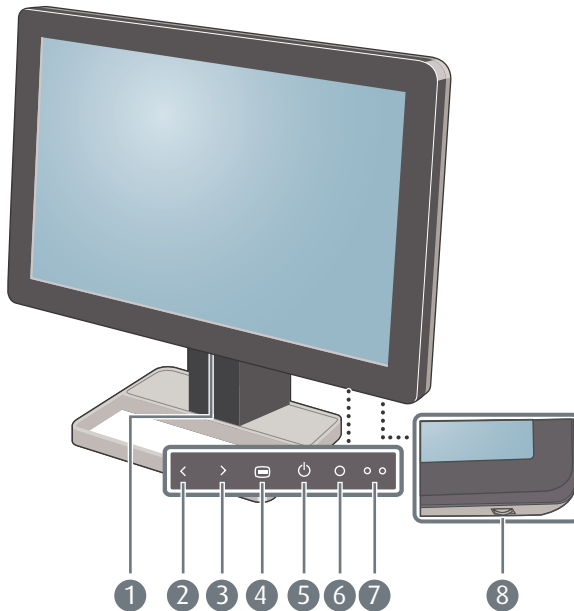

- 
- |   |                              |   |                      |
|---|------------------------------|---|----------------------|
| 1 | USB downstream connectors    | 2 | Left/Down key        |
| 3 | Right/Up key                 | 4 | Enter key            |
| 5 | Stand-by key                 | 6 | Ambient light sensor |
| 7 | Power status indicator light | 8 | Control wheel        |
-



## Rear view

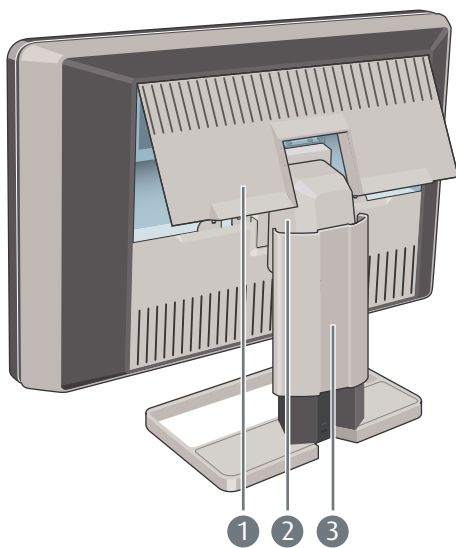

---

1 Connector compartment cover

2 Neck cover

---

3 Display stand cover

---

## CORONIS FUSION 4MP

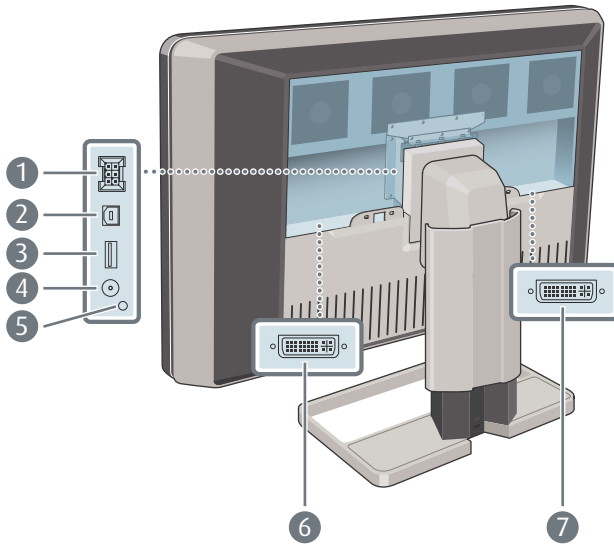

- |   |  |   |   |
|---|--|---|---|
| 1 | +24 VDC power input                    | 2 | USB upstream connector                      |
| 3 | USB downstream connector               | 4 | +5 VDC, 0.25 A power output for accessories |
| 5 | +3.3 VDC, 0.25A auxiliary power output | 6 | DVI 1 video input                           |
| 7 | DVI 2 video input                      |   |   |

## CORONIS FUSION 6MP

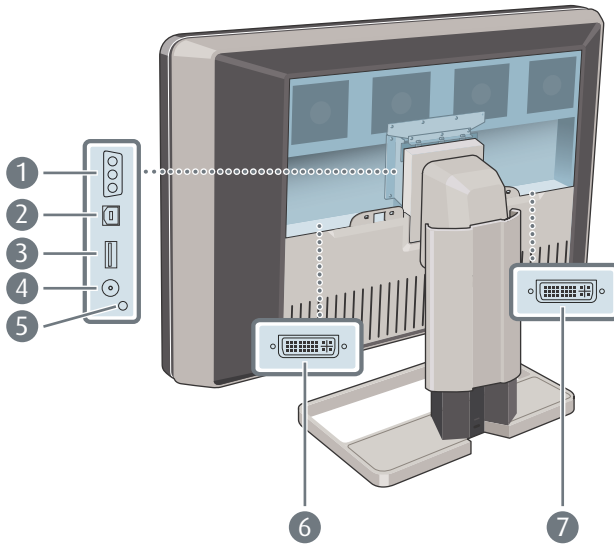

- |   |  |   |   |
|---|--|---|---|
| 1 | +24 VDC power input                    | 2 | USB upstream connector                      |
| 3 | USB downstream connector               | 4 | +5 VDC, 0.25 A power output for accessories |
| 5 | +3.3 VDC, 0.25A auxiliary power output | 6 | DVI 1 video input                           |
| 7 | DVI 2 video input                      |   |   |

# Display installation



Prior to installing your CORONIS FUSION 4MP/6MP display and connecting all necessary cables, make sure to have a suitable display controller physically installed in your computer. If you are using a Barco display controller, please consult the dedicated user guide available on the system CD.

## Removing the covers

### CONNECTOR COMPARTMENT COVER

The connector compartment cover should be removed to get access to the connectors. To remove the cover, proceed as follows:

- 1 Gently lift the clips at one of the handles of the connector compartment cover to release that side of the cover.
- 2 Do the same at the other side of the cover.
- 3 Remove the cover.

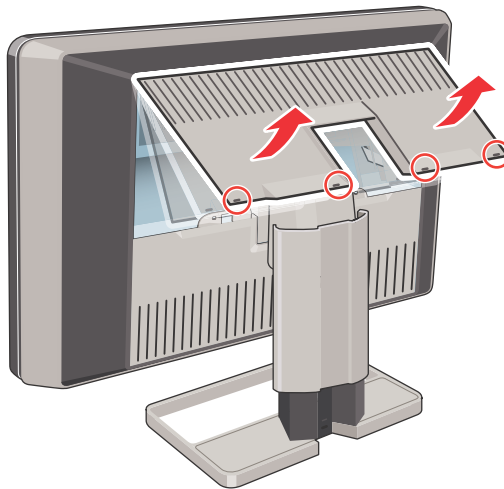

## DISPLAY STAND COVER

To get access to the cable routing channel, the display stand cover should be removed. This can be done as follows:

- 1 Gently press and hold the clips at the inside top of the cover.

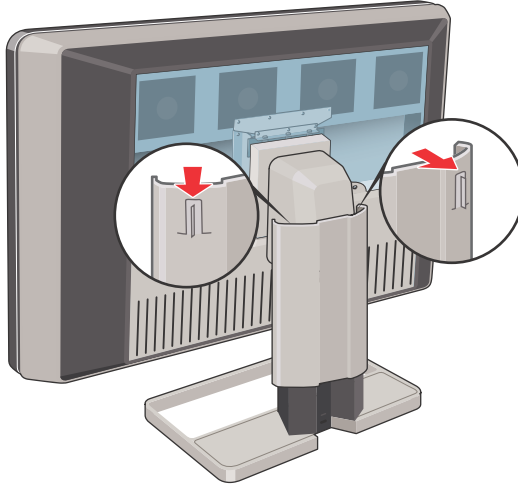

- 2 Slide the cover upwards while holding the clips pressed.

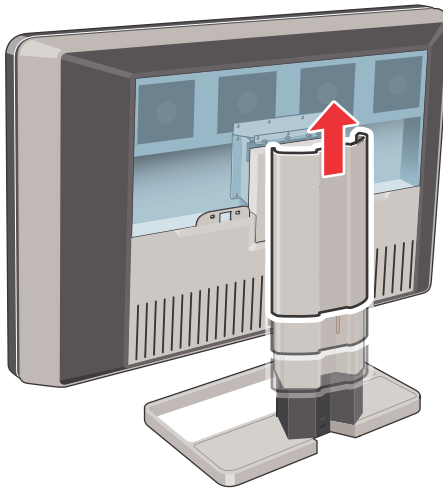

## Unlocking the height mechanism

In the factory, the height-positioning system in the display stand is locked with a red hook to prevent damage during transportation. You'll have to remove this hook before adjusting your display height position.

- 1 While holding the display panel pushed down, pull out the red hook in the display stand.

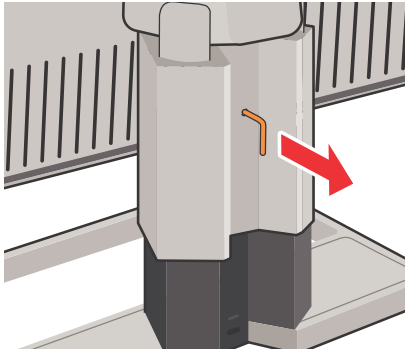

To retain the hook for possible future transportation, insert the short, red end of the hook back into the stand of your display.

## Adjusting the display position

Now that the height-positioning system of your display is unlocked, you can tilt, swivel, raise and lower the display as desired.



Do not try to pivot your display when attached to the stand. Trying to do so could cause serious damage to your display and its stand.

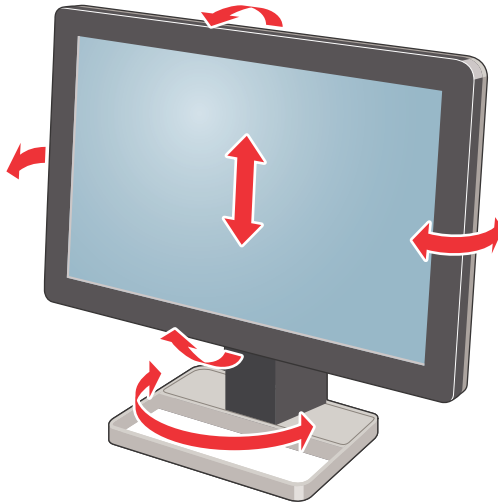

## Connecting the signal cables

- 1 Connect one head of the display controller to the DVI 1 connector with one of the supplied DVI cables.
- 2 Connect another head of the display controller to the DVI 2 connector with one of the supplied DVI cables.

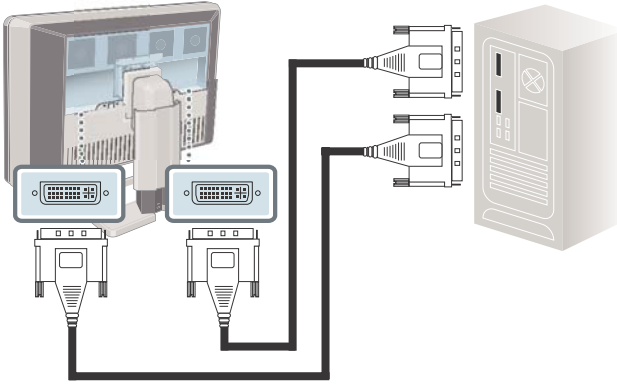

- 3 If you want to make use of your display's USB downstream connectors, connect a PC USB downstream connector to the display's USB upstream connector by means of the supplied USB 2.0 cable.

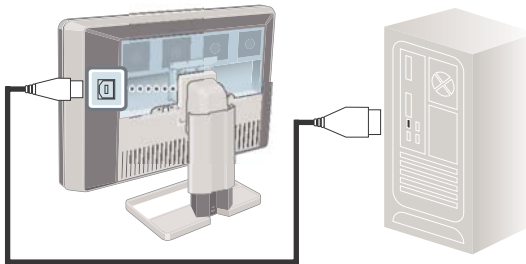



## Connecting the power cables

- 1 Connect the supplied external DC power supply to the +24 VDC power input of your CORONIS FUSION 4MP/6MP display.
- 2 Plug the other end of the external DC power supply into a **grounded** power outlet by means of the proper power cord delivered in the packaging.

## Routing the cables

Route all connected cables through the cable routing channel in the stand of your display.



The cable straps at the inside of the connector compartment allow you to fix the cables for better shielding of the cables.

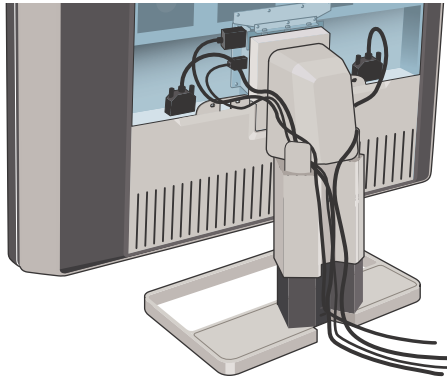

## Re-attaching the covers

- 1 Re-attach the display stand cover by sliding it downward. You'll hear a "click" sound of the cover's clips when the display stand cover is in position.



Pay attention that all cables stay in the cable channel while replacing the cover.

- 2 Re-attach the connector compartment cover by sliding the cover's top in position and then push the cover's bottom. You'll hear a "click" sound of the cover's clips when the connector compartment cover is in position.

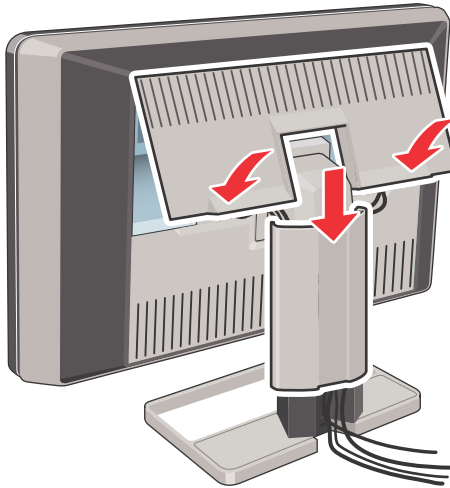

## VESA-mount installation

The panel, standard attached to a stand, is compatible with the VESA 100 mm standard. Thus, it can be used with an arm that is approved by VESA. This chapter shows you how to release the panel from the stand and how to attach it to an arm. If you're not using an arm, you can skip this chapter.

- 1 Gently pull open both lower sides of the cover.

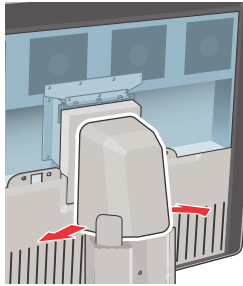

- 2 Slide the cover upwards while holding the lower sides pulled open.

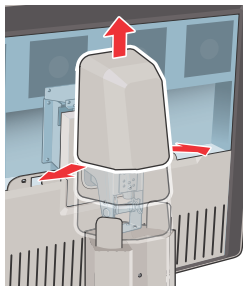

- 3 Lift the plastic frame that covers the fixation of the panel to the stand. Turn it for 45 degrees to uncover the fixation screws.

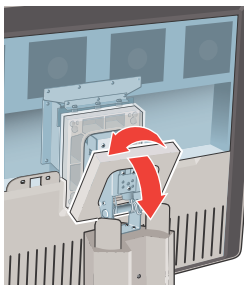

- 4 Unscrew the four fixation screws fixing the panel to the stand.

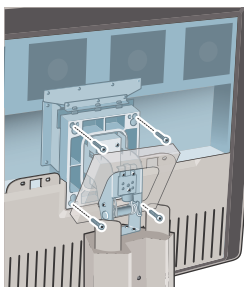

- 5 Attach the panel **firmly** to the arm using 4 screws M4 x 10 mm.



You should mount the panel in landscape position. Portrait position is possible but not supported.



Use an arm that can support a weight of at least 21.6 kg (47.62 lbs). Failure to do so could make the panel fall, causing serious injury to a child or adult, and serious damage to the equipment.

# First time starting up

You are now ready to start up your CORONIS FUSION 4MP/6MP display system for the first time.

- 1 Switch on your CORONIS FUSION 4MP/6MP display as described in “**Stand-by switching**” on page 24.
- 2 Turn on the computer connected to your display.

If you have properly installed your display and display controller, the Windows start-up messages will appear once the boot procedure is finished.



Your CORONIS FUSION 4MP/6MP display will be running in a basic video mode at a default refresh rate when first time starting up.

If you are using a Barco display controller, please consult the dedicated user guide available on the system CD to install the drivers, software and documentation. When this is done, your display will automatically detect the connected video input signal(s) and apply the correct video mode and refresh rate.

# Daily operation

## Recommendations for daily operation

### OPTIMIZE THE LIFETIME OF YOUR DISPLAY

Enabling the Display Power Management System (DPMS) of your display will optimize its diagnostic lifetime by automatically switching off the backlight when the display is not used for a specified period of time. By default, DPMS is enabled on your display, but it also needs to be activated on your workstation. To do this, go to “Power Options Properties” in the “Control Panel”.



Barco recommends setting DPMS activation after 20 minutes of non-usage.

### USE A SCREEN SAVER TO AVOID IMAGE RETENTION

Prolonged operation of an LCD with the same content on the same screen area may result in a form of image retention.

You can avoid or significantly reduce the occurrence of this phenomenon by using a screen saver. You can activate a screen saver in the “Display properties” window of your workstation.



Barco recommends setting screen saver activation after 5 minutes of non-usage. A good screen saver displays moving content.

In case you are working with the same image or an application with static image elements for several hours continuously (so that the screen saver is not activated), change the image content regularly to avoid image retention of the static elements.

### UNDERSTAND PIXEL TECHNOLOGY

LCD displays use technology based on pixels. As a normal tolerance in the manufacturing of the LCD, a limited number of these pixels may remain either dark or permanently lit, without affecting the diagnostic

performance of the product. To ensure optimal product quality, Barco applies strict selection criteria for its LCD panels.



To learn more about LCD technology and missing pixels, consult the dedicated white papers available at [www.barco.com/medical](http://www.barco.com/medical).

## ENHANCE USER COMFORT

Every Barco multi-head display system is color matched with the highest specification in the market.



Barco recommends keeping color-matched displays together. Furthermore, it is important to use all displays of a multi-head configuration at the same rate to preserve color matching throughout the economic lifetime of the system.

## MAXIMIZE QUALITY ASSURANCE



The 'MediCal QAWeb' system offers online service for high-grade Quality Assurance, providing maximum diagnostic confidence and uptime.



Barco recommends to install MediCal QAWeb Agent and apply the default QAWeb policy at least. This policy includes calibration on regular intervals. Upgrading to MediCal QAWeb Server offers even more possibilities. Learn more and sign up for the free MediCal QAWeb Essential level at [www.barco.com/medical/qa](http://www.barco.com/medical/qa)

# Stand-by switching

## USING THE TOUCH KEYS:

- 1 While the OSD is not on the screen, touch any touch key. As a result, the control panel illumination is switched on for a few seconds.
- 2 While the control panel illumination is on, touch the stand-by  touch key. A message appears on the screen.
- 3 Touch the stand-by  touch key once more to confirm.
- 4 To switch the display on while it is in stand-by, touch any touch key. Next, while the control panel illumination is on, touch the stand-by  touch key.

## USING THE CONTROL WHEEL:

- 1 While the OSD is not on the screen, click the control wheel shortly. A message appears on the screen.
- 2 Click the control wheel once more to confirm.
- 3 To switch the display on while it is in stand-by, click the control wheel shortly.

# Bringing up the OSD menu

## USING THE TOUCH KEYS:

- 1 While the OSD is not on the screen, touch any touch key. As a result, the control panel illumination is switched on for a few seconds.
- 2 While the control panel illumination is on, touch the Enter  touch key.

## USING THE CONTROL WHEEL:

While the OSD is not on the screen, rotate the control wheel.



# Navigating through the OSD menus

## USING THE TOUCH KEYS:

- 1 Use the Up > and Down < keys to move through the menus.
- 2 To go into a submenu, use the Up > or Down < key to highlight the submenu. Next, touch the Enter  key to go into the submenu.
- 3 When you select **Exit**, the OSD exits the submenu and jumps to the previous (higher-level) menu. When you select **Exit** in the main menu, the OSD is hidden.

## USING THE CONTROL WHEEL:

- 1 Rotate the control wheel to move up and down through the menus.
- 2 To go into a submenu, rotate the control wheel to highlight the submenu. Next, click the control wheel to go into the submenu.
- 3 When you click on **Exit**, the OSD exits the submenu and jumps to the previous (higher-level) menu. When you click on **Exit** in the main menu, the OSD is hidden.

# Making selections in the OSD menus

## USING THE TOUCH KEYS:





- 1 Navigate through the menus and highlight the parameter you wish to select.
- 2 Touch the Enter  key to make a selection or toggle between several settings.

## USING THE CONTROL WHEEL:

- 1 Navigate through the menus and highlight the parameter you wish to select.
- 2 Click the control wheel to make a selection or to toggle between several settings.

# Changing values in the OSD menus

## USING THE TOUCH KEYS:

- 1 Navigate through the menus and highlight the parameter you wish to adjust.
- 2 Touch the Enter  key to go into edit mode.
- 3 Use the Up  or Down  key to change the value.
- 4 Touch the Enter  key to enter the new value and return to the menu.

## USING THE CONTROL WHEEL:

- 1 Navigate through the menus and highlight the parameter you wish to adjust.
- 2 Click the control wheel to go into edit mode.
- 3 Rotate the wheel to change the value.
- 4 Click the wheel to enter the new value and return to the menu.

# Advanced operation

## Info messages

The following messages may appear automatically on the screen:

### INPUT SELECTION

The Input selection menu appears in case 2 video signals are connected and the resolution of one or both video signals is too high to display them both.

In that case the input selection menu allows you to select one of both video signals.

### NO SIGNAL SELECTED

This message appears in case the display finds no proper video signal at its inputs.

### RESOLUTION TOO HIGH

This message appears in case the resolution of the selected video signal is too high to display.

### TEXT MODE / DIAGNOSTIC MODE

These messages appear for a few seconds directly after switching to Text mode or Diagnostic mode.

In text mode, the display luminance is approximately half of the luminance in diagnostic mode. Text mode is intended for using the display with office applications such as word processing. You can switch between both modes by touching the up > and down < keys at the same time.

## LCM TEMPERATURE TOO HIGH



This is a serious error message. You should power off the display and call for service.

The warning means the LCD panel temperature is too high. As a result the display switches to a safe operating mode (with decreased backlight value). The message will not disappear until the display is powered off.

## LCM TEMPERATURE SENSOR OFF LINE



This is a serious error message. You should power off the display and call for service.

The warning means the LCD panel temperature sensor has lost communication. As a result the display switches to a safe operating mode (with decreased backlight value). The message will not disappear until the display is powered off.

# On-screen display (OSD)

## Luminance and color menu

<b>Measured luminance</b>	Indicates the actual luminance measured by the internal sensor. This is a read-only value. It is expressed in cd/m <sup>2</sup> .
<b>Luminance target</b>	Allows to manually adjust the luminance target. See note below.
<b>Color target</b>	Allows to select from a list of factory-defined and user-defined color targets.
<b>Viewing mode</b>	Allows to select the viewing mode: Diagnostic or Text. In text mode the luminance is approximately half of the luminance in diagnostic mode. This is intended for use with office applications such as word processing. You can also switch between both modes by touching the up <b>&gt;</b> and down <b>&lt;</b> keys at the same time while the OSD is not on the screen.
<b>Color definition</b>	Jumps to the color definition submenu, which allows to change the definition of the user-defined color targets.



When you change the luminance target, the display will adjust its backlight to reach the target. This can be seen in the Measured luminance line.

When the luminance target cannot be reached, e.g., due to aging of the backlight, the Measured luminance line changes to *Minimum value reached* or *Maximum value reached*.

## COLOR DEFINITION SUBMENU

A color target is defined by its luminance target and color temperature. The color definition submenu allows to edit these values.

<b>Color name</b>	Indicates the color target you are editing. You can select another color target to edit by using the Up > and Down < touch keys or by rotating the control wheel.
<b>Luminance target</b>	Allows to select the luminance target that corresponds to the color target.
<b>Defined in</b>	<p>Indicates how the color temperature is defined: in (x,y) co-ordinates or Kelvin (K). You can switch between both by using the Up &gt; and Down &lt; touch keys or by rotating the control wheel.</p> <p>This function is available only when the User color target is selected.</p>
<b>x</b>	<p>Allows to define the x co-ordinate of the color temperature that corresponds to the color target.</p> <p>This function is available only when the color target is defined in (x,y) co-ordinates.</p> <p>This function is not available when the Native White color target is selected.</p>
<b>y</b>	<p>Allows to define the y co-ordinate of the color temperature that corresponds to the color target.</p> <p>This function is available only when the color target is defined in (x,y) co-ordinates.</p> <p>This function is not available when the Native White color target is selected.</p>

<b>Color temperature</b>	<p>Allows to define the color temperature that corresponds to the color target in Kelvin units.</p> <p>This function is available only when the color target is defined in Kelvin units.</p> <p>This function is available only when the User color target is selected.</p>
<b>Restore factory x, y values</b>	<p>Allows to reset the (x,y) co-ordinates of the color temperature to the factory values.</p> <p>This function is not available when the Native White color target is selected.</p>

## Display Function menu

<b>Display function</b>	<p>Allows to select from a list of pre-defined display functions.</p> <p>If the DICOM DF is selected, a number of additional settings is available.</p>
<b>ALC &amp; DICOM options</b>	<p>Jumps to the ALC &amp; DICOM Options submenu, which allows to edit the settings for the DICOM display function.</p> <p>This function is available only when the DICOM DF is selected.</p>

## ALC & DICOM OPTIONS SUBMENU

<b>Measured ambient light</b>	Indicates the ambient light actually measured by the ambient light sensor on the front of the display. This is a read-only value.
<b>Averaged ambient light</b>	<p>Shows the average of the measured ambient light since the display was switched on.</p> <p>When you execute the function “Measure ALC Value”, this value will be stored as the Measured ALC correction value for the selected reading room, unless this value is higher than the maximum ambient light determined for the selected reading room.</p>
<b>Correction value</b>	Shows the ambient light correction value that is taken into account in the calculation of the display function.
<b>Cont. DICOM ALC</b>	<p>Allows to switch continuous DICOM ALC on/off.</p> <p>When switched on, the DICOM DF is recalculated <i>continuously</i> taking the averaged ambient light into account.</p> <p>When switched off, the DICOM DF is recalculated <i>only</i> at the moment the DICOM Offset is changed (see below).</p>



<p><b>DICOM offset</b></p>	<p>This function is available only when the DICOM DF is selected. When Continuous DICOM ALC is switched off, the DICOM DF is recalculated at the moment the DICOM Offset is changed, taking the new DICOM Offset into account.</p> <ul style="list-style-type: none"> <li>• When set to “Dark Room”, the ambient light is not taken into account.</li> <li>• When set to “Preset”, a preset ambient light value determined by the selected reading room is taken into account.</li> <li>• When set to “Measured ALC”, the averaged ambient light, determined by the selected reading room, is taken into account.</li> </ul> <p>This function is available only when Continuous DICOM ALC is off.</p>
<p><b>Reading room</b></p>	<p>Allows to select from a pre-defined list of reading room types.</p> <p>You must select a reading room that corresponds to the type of room the display is installed in.</p> <p>This function is available only when Continuous DICOM ALC is off.</p>
<p><b>Reading room def.</b></p>	<p>Jumps to the reading room definition submenu, which allows to edit the reading room condition settings.</p> <p>This function is available only when Continuous DICOM ALC is off.</p>

<b>Calibration info</b>	Jumps to the calculation information submenu, which displays information about the values taken into account to recalculate the DICOM DF.
-------------------------	---

## READING ROOM DEFINITION SUBMENU

<b>Measured ambient light</b>	Indicates the ambient light actually measured by the ambient light sensor on the front of the display. This is a read-only value.
<b>Averaged ambient light</b>	Shows the average of the measured ambient light since the display was switched on. This is a read-only value.
<b>Reading room</b>	Indicates the reading room type you are editing. You can select another room to edit by using the Up > or Down < touch keys or rotating the control wheel.
<b>Max. ambient light</b>	<p>This indicates the maximum ambient light that corresponds to the selected reading room.</p> <p>If the measured ambient light is higher than the value entered here, you should take measures to darken the room or select another reading room type.</p>
<b>Preset corr. value</b>	<p>This value is taken into account in the calculation of the DICOM DF if Continuous DICOM ALC is switched off and DICOM Offset is set to "Preset".</p> <p>To each reading room type corresponds another preset value.</p>

<b>Measured ALC value</b>	<p>The value shown here is taken into account in the calculation of the DICOM DF if Continuous DICOM ALC is switched off and DICOM Offset is set to "Measured ALC".</p> <p>When you select this line and confirm the selection, the actual averaged ambient light value is stored here, overwriting the former value.</p> <p>However, if the averaged ambient light value is higher than the maximum ambient light value that corresponds to the selected reading room, a warning is displayed prompting you to dim the light in the room, and the value will be limited to the maximum ambient light value.</p> <p>If you dim the light in the room you can execute the Measure ALC Value function again to enter the new, lower value.</p>
---------------------------	--

## CALIBRATION INFORMATION SUBMENU

<b>Preset ambient value / Measured ALC ambient value / Average ambient value</b>	<p>Shows the ambient light correction value taken into account to calculate the DICOM DF, expressed in lux.</p>
<b>Bright luminance</b>	<p>Shows the bright luminance value taken into account to calculate the DICOM DF.</p>
<b>Dark luminance</b>	<p>Shows the dark luminance value taken into account to calculate the DICOM DF.</p>
<b>Ambient correction</b>	<p>Shows the ambient light correction value taken into account to calculate the DICOM DF, expressed in cd/m<sup>2</sup>.</p>

## Settings menu

<b>DPMS</b>	Allows to switch the display power management system on/off. See note below.
<b>Power LED</b>	Allows to switch the power LED's on state on/off. The LED's orange DPMS state is not influenced by this setting. So, when the display goes into power-saving mode, the LED will turn orange, even if it was switched off by this setting
<b>User controls</b>	<p>Allows to disable the user controls on the front.</p> <p>When switched off, the user cannot display the OSD until the user controls keycode is entered.</p> <p>To enable the user controls again, <b>To enable the user controls again using the touch keys:</b>, on page 40 or <b>To enable the user controls again using the control wheel:</b>, on page 40</p>
<b>Sound</b>	Allows to switch the sound on/off. When switched on, a short beep sounds each time you touch a soft touch key.
<b>Auto menu exit</b>	Allows to switch the automatic menu exit on/off. When switched on, the OSD is closed automatically when left idle for a certain time.

<b>OSD Orientation</b>	<p>Select the desired orientation of the on-screen display. The default position is Landscape, but if you put the display in portrait orientation (possible but not supported), you should select Portrait as OSD orientation as well. If not, the OSD will not be easily readable.</p>
<b>Input Switch Mode</b>	<p>Select “Auto” if you wish the display to select the video inputs automatically. If only one video input is connected, the image will be shown in the center of the screen. If both video inputs are connected, the video signal connected to the “Left” input is shown on the left side of the screen and the signal connected to the “Right” connector is shown on the right side. If one of the video signals exceeds the resolution of 1640x2048, the signal is suppressed.</p> <p>Select “Left” to display only the signal connected to the “Left” video input.</p> <p>Select “Right” to display only the signal connected to the “Right” video input.</p>
<b>Preferred Input</b>	<p>Select the video resolution you wish the connected graphic board(s) to reproduce. Before changing this setting you must switch off the PC. After changing the setting, switch on the PC so that the graphic board changes its resolution.</p> <p>This function takes effect with plug-and-play graphic boards only.</p> <p>More information can also be found in the Getting Started manual.</p>

<b>Exclude I Guard zone</b>	When switched on, the video resolution of the preferred input is set to a value with a reduced number of lines. The image will be displayed below the I-Guard patch.
<b>Scaling</b>	When switched on, the display will enlarge (scale up) low resolution video signals if possible.



The DPMS system will power down the display when the connected computer is left idle for a certain time.



Barco recommends to switch DPMS on to prevent image burn-in (image retention) on the LCD panel..

## Information menu

<b>Product</b>	The display type
<b>Serial No</b>	Indicates the display serial number
<b>SW Number</b>	The order no. of the internal software
<b>SW Version</b>	Displays the current internal software version
<b>Display Runtime</b>	Indicates the total time the display has been operating, including the time in stand-by
<b>Backlight Runtime</b>	Indicates the total time the display has been operating, excluding the time in stand-by

# Changing the viewing mode

## ABOUT VIEWING MODES

The display contains two viewing modes. Diagnostic viewing mode provides the full calibrated luminance. This mode is intended for using the display in diagnostic applications.

In Text mode, the luminance is approximately half of the luminance in Diagnostic mode. This is intended for using the display with office applications such as word processing.

## SWITCHING VIEWING MODES BY MEANS OF THE KEYS

While the OSD is not on the screen, touch the Up > and Down < touch keys at the same time. As a result the display switches to another viewing mode. The viewing mode is indicated by a message that appears for a few seconds after switching the viewing mode.

## SWITCHING VIEWING MODES BY MEANS OF THE OSD MENU

You can also switch viewing modes in the Luminance and color menu.





# Enabling/disabling User Controls

## TO DISABLE THE USER CONTROLS:

- 1 Open the OSD main menu.
- 2 Open the **Settings** menu.
- 3 Select **User Controls**.
- 4 Select **Off**.
- 5 Return to the Settings menu.
- 6 Exit the OSD

Now the user cannot display the OSD again until the user controls keycode is entered (see below).

### TO ENABLE THE USER CONTROLS AGAIN USING THE TOUCH KEYS:

- 1 To enter the **user controls** keycode, the OSD must not be visible.
- 2 Touch any of the soft touch keys to switch on the front illumination.
- 3 While the illumination is on, touch the following keys in successive order:  
Enter , Down , Up , Down , Enter .

As a result, the **User Controls** setting in the Settings menu is switched on again.

### TO ENABLE THE USER CONTROLS AGAIN USING THE CONTROL WHEEL:

- 1 The OSD must not be visible.
- 2 Press and hold the control wheel for at least 5 seconds.
- 3 Rotate the control wheel **1 step clockwise**.
- 4 Press the control wheel **2 times**.
- 5 Rotate the control wheel **1 step counterclockwise**. The on-screen display appears.



Steps 3 to 5 must be performed in maximum 3 seconds.

As a result, the **User Controls** setting in the Settings menu is switched on again.



# Switching Power LED on/off

## To SWITCH THE POWER LED ON/OFF:

- 1 Open the OSD main menu.
- 2 Open the **Settings** menu.
- 3 Select **Power LED**.
- 4 Select On or Off.
- 5 Return to the Settings menu.



When the display is switched in stand-by, the power LED will turn orange, even if the power LED setting is switched off. When the power LED setting is switched off, the LED will still turn on (green) when the display is on but receives no video signal.

# Switching DPMS on/off

## To SWITCH DPMS ON/OFF:

- 1 Open the main menu.
- 2 Open the **Settings** menu.
- 3 Select **DPMS**.
- 4 Select On or Off.
- 5 Return to the Settings menu.

# Changing Display Functions

## Concepts

- The Display Function menu lets you select a display function (DF).
- When you select the DICOM DF you can define the DICOM DF to be recalculated taking the ambient light into account. This can be a continuous recalculation (“Continuous DICOM ALC” on) or single recalculation (“Continuous DICOM ALC” off).
- When you choose for a single recalculation, the recalculation can be based on an illuminance of 0 lux (“Dark Room”) a preset value (“Preset”) or a single, real-time measurement (“Measured ALC”). Both Preset and Measured ALC correction values are determined by the selected reading room.
- In the case of “Preset” or “Measured ALC” you must select a reading room that corresponds to the type of room the display is installed in. E.g. if the display is installed in a room where CT scans are observed, the “CT/MR/NM” reading room is the preferred selection.
- The reading room is defined by 3 parameters:
  - **Maximum Ambient Light** defines the maximum light allowed in this type of room. This value can be adjusted within certain limits determined by the selected reading room.
  - **Preset Correction Value** is the predefined correction value for this reading room. This value can be adjusted within certain limits determined by the selected reading room.
  - **Measured ALC Value** is the averaged measured ambient light for this reading room. It can be changed by executing the “Measure ALC Value” function.
- The reading room parameters are pre-defined in the display according to the AAPM (American Association of Physicists in Medicine). However they can be changed within certain limits.

# Display function selection

## TO SELECT A DISPLAY FUNCTION (DF):

- 1 Open the main menu.
- 2 Open the **Display Function** menu.
- 3 Select **Display Function**.
- 4 Select the desired DF.
- 5 Return to the Display Function menu.

You can select the following DFs:

<b>DICOM</b>	Select a DICOM display function for most medical viewing applications.  The DICOM function results in more visible grayscales in the images.
<b>Dynamic Gamma 2.2</b> <b>Dynamic Gamma 1.8</b>	These are gamma functions that are shifted to take into account the non-zero luminance of an LCD panel when driven with a "black" signal.  They are especially useful in CT applications to improve the perception of low Hounsfield values.
<b>Native</b>	If you select Native, the native panel behavior will not be corrected.
<b>Test</b>	This is identical to the Native DF.
<b>Gamma 2.2</b> <b>Gamma 1.8</b>	Select one of these display functions in case the display is to replace a CRT display with a gamma of 1.8 or 2.2 respectively.
<b>User</b>	This is a user-definable DF.

# ALC & DICOM Options

## Continuous DICOM ALC

### INTRODUCTION

When you select the DICOM DF, the display offers the possibility to take the ambient light into account for calculating the DICOM display function. This function is called **Continuous DICOM ALC** (ALC is short for Ambient Light Compensation).

When Continuous DICOM ALC is switched **on**, the display will *continuously* adapt the DICOM DF based on the average measured ambient light.

When it is switched **off**, the DICOM DF will be recalculated *only* when another DICOM Offset is selected.

### TO SWITCH CONTINUOUS DICOM ALC ON/OFF:

- 1 Select the DICOM display function. See **To select a display function (DF)**:, on page 43
- 2 In the Display Function menu, select **ALC & DICOM Options**.
- 3 In the ALC & DICOM Options submenu, select **Cont. DICOM ALC**.
- 4 Select On or Off.
- 5 Return to the ALC & DICOM Options menu.



The ambient light is measured by the ALC sensor at the front.

## DICOM offset

### INTRODUCTION

When Continuous DICOM ALC is switched **off**, the DICOM DF will be recalculated *only* when another DICOM Offset is selected. The DICOM DF will be recalculated based on the new offset setting.

## TO SELECT A DICOM OFFSET:

- 1 Select the DICOM display function. See **To select a display function (DF)**, on page 43.
- 2 Switch Continuous DICOM ALC off. See **To switch continuous DICOM ALC on/off**, on page 44.
- 3 In the ALC & DICOM Options menu, select **DICOM Offset**.
- 4 Select an offset.
- 5 Return to the ALC & DICOM Options menu.

You can select the following offsets:

<b>Dark room</b>	The DICOM DF will be recalculated taking an ambient light value of 0 lux into account.  This means that the measured ambient light does <b>not</b> influence the DICOM DF.
<b>Preset</b>	The DICOM DF will be recalculated taking a preset ambient light value into account. This value is determined by the selected Reading Room and can be adjusted manually within certain limits.
<b>Measured ALC</b>	The DICOM DF will be recalculated taking the averaged measured ambient light value into account that is determined by the selected Reading Room. This value can be changed by executing the "Measure ALC Value" function in the Reading Room Definition submenu.

## Reading room selection

This function is available only when the DICOM display function is selected and Continuous DICOM ALC is off.

## TO SELECT A READING ROOM SETTING:

- 1 Select the DICOM display function. See **To select a display function (DF)**, on page 43.
- 2 Switch Continuous DICOM ALC off. See **To switch continuous DICOM ALC on/off**, on page 44.
- 3 In the ALC & DICOM Options menu, select **Reading Room**.
- 4 Select the reading room that corresponds to the room type the display is installed in.
- 5 Return to the menu.

You can select the following reading room types:

<b>DRR CR/DR/MAMMO</b>	Corresponds to light conditions in diagnostic reading rooms for computed radiology, digital radiology or mammography. This setting has the lowest maximum ambient light.
<b>DRR CT/MR/NM</b>	Corresponds to light conditions in diagnostic reading rooms for computed tomography, magnetic resonance or nuclear medicine scans.
<b>Staff Office</b>	Corresponds to light conditions in office rooms.
<b>Clinical Viewing</b>	Corresponds to light conditions in diagnostic reading rooms for clinical viewing.
<b>Emergency Room</b>	Corresponds to light conditions in emergency rooms.
<b>Operating Room</b>	Corresponds to light conditions in operating rooms. This setting has the highest maximum ambient light.

## Reading room definition

This function is available only when the DICOM display function is selected and Continuous DICOM ALC is off.

### TO MODIFY A READING ROOM DEFINITION:

- 1 Select the DICOM display function. See **To select a display function (DF)**, on page 43.
- 2 Switch Continuous DICOM ALC off. See **To switch continuous DICOM ALC on/off**, on page 44.
- 3 In the ALC & DICOM Options menu, select **Reading Room Def.**
- 4 Select the reading room definition you wish to modify. There to, first select **Reading Room**. Select the appropriate reading room.
- 5 To modify the *maximum ambient light* for this reading room, select **Max. Ambient Light** and change the value.

You can change this value within certain limits determined by the selected reading room.

- 6 To modify the *Preset correction value* for this reading room, select **Preset Corr. Value** and change the value.

You can change this value within certain limits determined by the selected reading room.



- 7 To modify the *Measured ALC Value* for this reading room, select **Measure ALC Value** and execute the function.

If the “Averaged Ambient Light” at that moment is lower than the defined “Maximum Ambient Light”, the averaged ambient light value is copied as Measured ALC value.

If the “Averaged Ambient Light” at that moment is higher than the defined “Maximum Ambient Light”, the display will prompt a warning for the user to take measures to adapt the ambient light in the room to the selected reading room. Proceed as follows:

- Use Enter  or click the control wheel. As a result the Measured ALC value will be limited to the maximum ambient

light value. Use Enter  or click the control wheel again to store the value.

- However, if you wish to adapt the ambient light conditions to the definition of the selected reading room, dim the light in the room so that the measured ambient light becomes lower than the maximum ambient light.
- Then use Enter  or click the control wheel again to execute the Measure ALC Value function once more. As a result the actually measured ambient light value will be copied as Measured ALC Value. Finally use Enter  or click the control wheel again to store the value.



# Cleaning your display

## Front glass

Clean the front glass using a sponge, cleaning cloth or soft tissue, **lightly**



Before cleaning the front glass, unplug the power cable from the mains to prevent the keys from being activated inadvertently by sweeping over them.

moistened with one of the following tested products:

- Flux
- Windex Glass Plus
- Bohle glass cleaner
- Mr. Proper
- Pril
- Ajax glass cleaner
- Sidolin glass cleaner
- 25% ethanol solution (EtOH)

In case none of the above cleaning products is available, use plain water.



Take care not to damage or scratch the front glass. Be careful with rings or other jewelry and do not apply excessive pressure on the front glass.



Do not apply or spray liquid directly to the front glass as excess liquid may cause damage to internal electronics. Instead, apply the liquid to the cleaning cloth.



Do not use following products:

- Alcohol/solvents at higher concentration > 5%
- Strong alkalis lye, strong solvents
- Acid
- Detergents with fluoride
- Detergents with ammonia
- Detergents with abrasives
- Steel wool
- Sponge with abrasives
- Steel blades
- Cloth with steel thread

## Cabinet

- 1 Clean the cabinet using a soft cotton cloth, **lightly** moistened with a recognized cleaning product for medical equipment.

The cabinet has been tested for resistance to the following products:

- Cidex, Betadine
- Alcohol (Isopropyl and Ethyl)
- Ammonia-based cleaners (Windex)
- Aquasonic Gel

In case none of the above cleaning products is available, use plain water.



Do not apply or spray liquid directly to the cabinet as excess liquid may cause damage to internal electronics. Instead, apply the liquid to the cleaning cloth.

- 2 Repeat with water only.
- 3 Wipe dry with a dry cloth.

# Important information

## Safety information

### GENERAL RECOMMENDATIONS

Read the safety and operating instructions before operating the display.

Retain safety and operating instructions for future reference.

Adhere to all warnings on the display and in the operating instructions manual.

Follow all instructions for operation and use.

### ELECTRICAL SHOCK

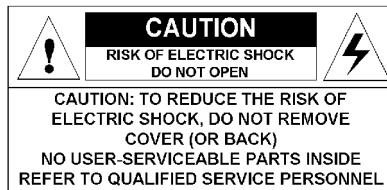

### TYPE OF PROTECTION (ELECTRICAL):

Display with external power supply: Class I equipment

### DEGREE OF SAFETY (FLAMMABLE ANESTHETIC MIXTURE):

Equipment not suitable for use in the presence of a flammable anesthetic mixture with air or with oxygen or nitrous oxide.

### NON-PATIENT CARE EQUIPMENT

Equipment primarily for use in a health care facility that is intended for use where contact with a patient is unlikely.

## **POWER CONNECTION - DISPLAY WITH EXTERNAL 24 VDC POWER SUPPLY**

- Power requirements: The display must be powered using the delivered medical approved 24 VDC SELV power supply.
- The medical approved DC power supply must be powered by the AC mains voltage (protective earth terminal).

### **POWER CORDS:**

- Utilize a UL-listed detachable power cord, 3-wire, type SJ or equivalent, 18 AWG min., rated 300 V min., provided with a hospital-grade type plug 5-15P configuration for 120V application, or 6-15P for 240V application.
- Do not overload wall outlets and extension cords as this may result in fire or electric shock.
- Mains lead protection (U.S.: Power cord): Power cords should be routed so that they are not likely to be walked upon or pinched by items placed upon or against them, paying particular attention to cords at plugs and receptacles.

### **WATER AND MOISTURE**

Never expose the display to rain or moisture.

Never use the display near water - e.g. near a bathtub, washbasin, swimming pool, kitchen sink, laundry tub or in a wet basement.

### **VENTILATION**

Do not cover or block the ventilation openings in the cover of the set. When installing the display in a cupboard or another closed location, heed the necessary space between the set and the sides of the cupboard.

### **INSTALLATION**

Place the display on a flat, solid and stable surface that can support the weight of at least 3 displays. If you use an unstable cart or stand, the

display may fall, causing serious injury to a child or adult, and serious damage to the equipment.

### **THE CORONIS FUSION 4MP CONFORMS TO:**

UL 60601-1 1ST EDITION, CAN/CSA-C22.2 NO. 601.1-M90, IEC 60601-1 2ND ED:1988 + A1:1991 + A2:1995, IEC 60950-1:2001 1ST EDITION, CE - 89/336/EEC, CE - 93/42/EEC, DEMKO - EN 60601-1, BSMI - CNS13438(95) + CNS14336(94), VCCI, FCC class B, ICES-001 Level B, MDD class IIb, FDA 510k, RoHS

### **THE CORONIS FUSION 6MP CONFORMS TO:**

UL 60601-1 1ST EDITION, CAN/CSA-C22.2 NO. 601.1-M90, IEC 60601-1 2ND ED:1988 + A1:1991 + A2:1995, IEC 60950-1:2001 1ST EDITION, CE - 89/336/EEC, CE - 93/42/EEC, DEMKO - EN 60601-1, CCC - GB9254-1998 + GB4943-2001 + GB17625.1-2003,, BSMI - CNS13438(95) + CNS14336(94), VCCI, FCC class B, ICES-001 Level B, KETI (eK) Level B, BSMI, MDD class IIb, FDA 510k, RoHS

### **NATIONAL SCANDINAVIAN DEVIATIONS FOR CL. 1.7.2:**

Finland: "Laitte on liitettävä suojamaadoituskoskettimilla varustettuun pistorasiaan"

Norway: "Apparatet må tilkoples jordet stikkontakt"

Sweden: "Apparaten skall anslutas till jordat uttag"

# Environmental information

## DISPOSAL INFORMATION (WASTE ELECTRICAL AND ELECTRONIC EQUIPMENT)



This symbol on the product indicates that, under European Directive 2002/96/EC governing waste from electrical and electronic equipment, this product must not be disposed of with other municipal waste. Please dispose of your waste equipment by handing it over to a designated collection point for the recycling of waste electrical and electronic equipment. To prevent possible harm to the environment or human health from uncontrolled waste disposal, please separate these items from other types of waste and recycle them responsibly to promote the sustainable reuse of material resources.

For more information about recycling of this product, please contact your local city office, your municipal waste disposal service or the shop where you purchased the product.

## MERCURY NOTICE

This Barco product consists of materials that may contain mercury, which must be recycled or disposed of in accordance with local, state, or country laws:

- Within this system, the backlight lamps in the monitor display contain mercury



## TURKEY RoHS COMPLIANCE



Republic of Turkey: In conformity with the EEE Regulation  
Türkiye Cumhuriyeti: EEE Yönetmeliğine Uygundur

## 中国大陆 RoHS (CHINESE MAINLAND ROHS)

根据中国大陆《电子信息产品污染控制管理办法》（也称为中国大陆 RoHS），以下部分列出了 Barco 产品中可能包含的有毒和/或有害物质的名称和含量。中国大陆 RoHS 指令包含在中国信息产业部 MCV 标准：“电子信息产品中有毒物质的限量要求”中。

According to the "China Administration on Control of Pollution Caused by Electronic Information Products" (Also called RoHS of Chinese Mainland), the table below lists the names and contents of toxic and/or hazardous substances that Barco's product may contain. The RoHS of Chinese Mainland is included in the MCV standard of the Ministry of Information Industry of China, in the section "Limit Requirements of toxic substances in Electronic Information Products".

零件项目 (名称) Component Name	有毒有害物质或元素 Hazardous Substances or Elements					
	铅 (Pb)	汞 (Hg)	镉 (Cd)	六价铬 (Cr6+)	多溴联苯 (PBB)	多溴二苯醚 (PBDE)
印制电路配件 Printed Circuit Assemblies	X	0	0	0	0	0
液晶面板 LCD panel	X	X	0	0	0	0
外接电(线)缆 External cables	X	0	0	0	0	0
内部线路 Internal wiring	0	0	0	0	0	0
金属外壳 Metal enclosure	0	0	0	0	0	0
塑胶外壳 Plastic enclosure	0	0	0	0	0	0
散热片(器) Heatsinks	0	0	0	0	0	0
风扇 Fan	0	0	0	0	0	0

电源供应器 Power supply unit	X	0	0	0	0	0
文件说明书 Paper manuals	0	0	0	0	0	0
光盘说明书 CD manual	0	0	0	0	0	0
<p>O: 表示该有毒有害物质在该部件所有均质材料中的含量均在 SJ/T 11363-2006 标准规定的限量要求以下。 O: Indicates that this toxic or hazardous substance contained in all of the homogeneous materials for this part is below the limit requirement in SJ/T11363-2006.</p> <p>X: 表示该有毒有害物质至少在该部件的某一均质材料中的含量超出 SJ/T 11363-2006 标准规定的限量要求。 X: Indicates that this toxic or hazardous substance contained in at least one of the homogeneous materials used for this part is above the limit requirement in SJ/T11363 2006.</p>						

在中国大陆销售的相应电子信息产品（EIP）都必须遵照中国大陆《电子信息产品污染控制标识要求》标准贴上环保使用期限（EFUP）标签。Barco 产品所采用的 EFUP 标签（请参阅实例，徽标内部的编号用于制定产品）基于中国大陆的《电子信息产品环保使用期限通则》标准。

All Electronic Information Products (EIP) that are sold within Chinese Mainland must comply with the "Electronic Information Products Pollution Control Labeling Standard" of Chinese Mainland, marked with the Environmental Friendly Use Period (EFUP) logo. The number inside the EFUP logo that Barco uses (please refer to the photo) is based on the "Standard of Electronic Information Products Environmental Friendly Use Period" of Chinese Mainland.





# Regulatory compliance information

## INDICATIONS FOR USE: CORONIS FUSION 4MP

The Coronis Fusion 4MP (MDCC-4130) display is a display device capable of displaying two 2MP display images electronically fused together on the one panel. It is intended to be used in displaying and viewing digital images for review and analysis by trained medical practitioners. It provides a screen resolution of 2560x 1600 pixels at a pixel pitch of 0.2505mm. This provides the equivalent resolution of 2 x 2MP displays.

The Coronis Fusion 4MP (MDCC-4130) display is not intended for primary diagnostic review of Mammography images.

Caution (USA): Federal law restricts this device to sale by or on the order of a physician or a practitioner trained on its use.

## INDICATIONS FOR USE: CORONIS FUSION 6MP

The Coronis Fusion 6MP DL (MDCC-6130) display is a display device capable of displaying two 3MP display images electronically fused together on the one panel. It is intended to be used in displaying and viewing digital images for review and analysis by trained medical practitioners. It provides a screen resolution of 3280 x 2048 pixels at a pixel pitch of 0.1995mm. This provides the equivalent resolution of 2 x 3MP displays.

The Coronis Fusion 6MP DL (MDCC-6130) display is not intended for primary diagnostic review of Mammography images.

Caution (USA): Federal law restricts this device to sale by or on the order of a physician or a practitioner trained on its use.

## FCC CLASS B

This device complies with Part 15 of the FCC Rules. Operation is subject to the following two conditions: (1) this device may not cause harmful interference, and (2) this device must accept any interference received, including interference that may cause undesired operation.

This equipment has been tested and found to comply with the limits for a Class B digital device, pursuant to Part 15 of the FCC Rules. These limits

are designed to provide reasonable protection against harmful interference in a residential installation. This equipment generates, uses and can radiate radio frequency energy and, if not installed and used in accordance with the instructions, may cause harmful interference to radio communications. However, there is no guarantee that interference will not occur in a particular installation. If this equipment does cause harmful interference to radio or television reception, which can be determined by turning the equipment off and on, the user is encouraged to try to correct the interference by one or more of the following measures:



- Reorient or relocate the receiving antenna.
- Increase the separation between the equipment and receiver.
- Connect the equipment into an outlet on a circuit different from that to which the receiver is connected.
- Consult the dealer or an experienced radio/TV technician for help.









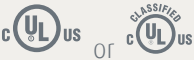

### CANADIAN NOTICE

This ISM device complies with Canadian ICES-001.  
Cet appareil ISM est conforme à la norme NMB-001 du Canada.

## Explanation of symbols

On the display or power supply, you may find the following symbols (nonrestrictive list):

	Indicates compliance to the essential requirements of the Directive 93/42/EEC
	Indicates compliance with Part 15 of the FCC rules (Class A or Class B)
	Indicates the display is approved according to the UL regulations

	<p>Indicates the display is approved according to the c-UL regulations</p>
	<p>Indicates the display is approved according to the DEMKO regulations</p>
	<p>Indicates the display is approved according to the CCC regulations</p>
	<p>Indicates the display is approved according to the VCCI regulations</p>
	<p>Indicates the USB connectors on the display</p>
	<p>Indicates the manufacturing date</p>
	<p>Indicates the temperature limitations for the display to operate within specs</p>
	<p>Indicates the display serial no.</p>
	<p>Consult the operating instructions</p>
	<p>Indicates this apparatus must not be thrown in the trash but must be recycled, according to the European WEEE (Waste Electrical and Electronic Equipment) directive</p>

# Legal disclaimer

## DISCLAIMER NOTICE

Although every attempt has been made to achieve technical accuracy in this document, we assume no responsibility for errors that may be found. Our goal is to provide you with the most accurate and usable documentation possible; if you discover errors, please let us know.

Barco software products are the property of Barco. They are distributed under copyright by Barco N.V. or Barco, Inc., for use only under the specific terms of a software license agreement between Barco N.V. or Barco Inc. and the licensee. No other use, duplication, or disclosure of a Barco software product, in any form, is authorized.

The specifications of Barco products are subject to change without notice.

## TRADEMARKS

All trademarks and registered trademarks are property of their respective owners.

## COPYRIGHT NOTICE

This document is copyrighted. All rights are reserved. Neither this document, nor any part of it, may be reproduced or copied in any form or by any means - graphical, electronic, or mechanical including photocopying, taping or information storage and retrieval systems - without written permission of Barco.

© 2011 Barco N.V. All rights reserved.

## PATENT INFORMATION

This product is covered under the following intellectual property rights:

US Patent 7,639,849  
US Patent 7,038,186  
US Patent 7,166,829  
US Patent 6,950,098  
European Patent 1 274 066.

# Technical specifications

## CORONIS FUSION 4MP

Product acronym	MDCC-4130
Screen technology	TFT AM Color LCD Dual Domain IPS-Pro
Active screen size (diagonal)	758.36 mm (29.9")
Active screen size (H x V)	641.208 x 404.808 mm (25.25 x 15.94")
Aspect ratio (H:V)	16:10
Resolution	native 4MP (2560 x 1600) configurable to 2 x 2MP+ (1280 x 1600) configurable to 2 x 2MP (1200 x 1600)
Pixel pitch	0.2505 mm
Color imaging	Yes
Gray imaging	Yes
Color support	30 bit
Viewing angle (H, V)	170°
Uniform Luminance Technology (ULT)	Yes
Per Pixel Uniformity (PPU)	No
Ambient Light Compensation (ALC)	Yes
Backlight Output Stabilization (BLOS)	Yes (1x)
I-Guard	Yes
Maximum luminance*	950 cd/m <sup>2</sup>
DICOM calibrated luminance (ULT off)*	500 cd/m <sup>2</sup>
Contrast ratio (typical)*	1100:1

<b>Response time (Tr + Tf)</b>	20 ms
<b>Scanning frequency (H; V)</b>	30-150 kHz; 15-80 Hz
<b>Housing color</b>	Black/Silver
<b>Video input signals</b>	DVI-D Dual Link (2x)
<b>Video inout terminals</b>	NA
<b>USB ports</b>	1 upstream (endpoint), 3 downstream
<b>USB standard</b>	2.0
<b>Power requirements (nominal)</b>	100-240V
<b>Power consumption (nominal)</b>	135W
<b>Power save mode</b>	Yes
<b>Power management</b>	DVI-DMPM
<b>Dot clock</b>	280 MHz
<b>OSD languages</b>	English, French, German, Spanish, Italian
<b>Dimensions with stand (W x H x D)</b>	Portrait: NA Landscape: 731 x 580-676 x 265 mm
<b>Dimensions w/o stand (W x H x D)</b>	Portrait: NA Landscape: 731 x 485 x 141 mm
<b>Dimensions packaged (W x H x D)</b>	869 x 764 x 400 mm
<b>Net weight with stand</b>	28.1 kg
<b>Net weight w/o stand</b>	21.6 kg
<b>Net weight packaged with stand</b>	37.6 kg
<b>Net weight packaged w/o stand</b>	NA
<b>Height adjustment range</b>	96 mm

<b>Tilt</b>	-5° / +25°
<b>Swivel</b>	-45° / +45°
<b>Pivot</b>	NA
<b>Mounting standard</b>	VESA (100 mm)
<b>Screen protection</b>	Protective, non-reflective glass cover
<b>Recommended modalities</b>	CT, MR, US, DR, CR, NM, Film
<b>Certifications</b>	UL 60601-1 1ST EDITION, CAN/CSA-C22.2 NO. 601.1-M90, IEC 60601-1 2ND ED:1988 + A1:1991 + A2:1995, IEC 60950-1:2001 1ST EDITION, CE - 89/336/EEC, CE - 93/42/EEC, DEMKO - EN 60601-1, BSMI - CNS13438(95) + CNS14336(94), VCCI, FCC class B, ICES-001 Level B, MDD class IIb, FDA 510k, RoHS
<b>Supplied accessories</b>	Getting Started Guide Quick-Installation Sheet Video cables (2 x DVI Dual Link) Main cables (UK, European (CEBEC/KEMA), USA (UL/CSA; adaptor plug NEMA 5-15P), Chinese (CCC)) USB 2.0 cable External power supply
<b>Optional accessories</b>	NA
<b>QA software</b>	MediCal QAWeb
<b>Unit per pallet</b>	NA
<b>Pallet dimensions</b>	NA
<b>Warranty</b>	5 years
<b>Operating temperature</b>	0°C to 35°C (15°C to 30°C within specs)
<b>Storage temperature</b>	-20°C to 60°C
<b>Operating humidity</b>	8% - 80% (non-condensing)
<b>Storage humidity</b>	5% - 95% (non-condensing)
<b>Operating altitude</b>	3000 m

\* In dark reading room conditions (0 lux)

## CORONIS FUSION 6MP

<b>Product acronym</b>	MDCC-6130 DL
<b>Screen technology</b>	TFT AM Color LCD Dual Domain IPS-Pro
<b>Active screen size (diagonal)</b>	772 mm (30.4")
<b>Active screen size (H x V)</b>	654 x 409 mm (25.8 x 16.1")
<b>Aspect ratio (H:V)</b>	16:10
<b>Resolution</b>	native 6MP (3280 x 2048) configurable to 2 x 3MP+ (1640 X 2048) configurable to 2 x 3MP (1536 X 2048)
<b>Pixel pitch</b>	0.1995 mm
<b>Color imaging</b>	Yes
<b>Gray imaging</b>	Yes
<b>Color support</b>	30 bit
<b>Viewing angle (H, V)</b>	178°
<b>Uniform Luminance Technology (ULT)</b>	Yes
<b>Per Pixel Uniformity (PPU)</b>	No
<b>Ambient Light Compensation (ALC)</b>	Yes
<b>Backlight Output Stabilization (BLOS)</b>	Yes (2x)
<b>I-Guard</b>	Yes
<b>Maximum luminance*</b>	800 cd/m <sup>2</sup>
<b>DICOM calibrated luminance (ULT off)*</b>	500 cd/m <sup>2</sup>
<b>Contrast ratio (typical)*</b>	1000:1
<b>Response time (Tr + Tf)</b>	18 ms



<b>Scanning frequency (H; V)</b>	30-150 kHz; 15-80 Hz
<b>Housing color</b>	Black/Silver
<b>Video input signals</b>	DVI-D Dual Link (2x)
<b>Video inout terminals</b>	NA
<b>USB ports</b>	1 upstream (endpoint), 3 downstream
<b>USB standard</b>	2.0
<b>Power requirements (nominal)</b>	100-240V
<b>Power consumption (nominal)</b>	166W
<b>Power save mode</b>	Yes
<b>Power management</b>	DVI-DMPM
<b>Dot clock</b>	280 MHz
<b>OSD languages</b>	English, French, German, Spanish, Italian
<b>Dimensions with stand (W x H x D)</b>	Portrait: NA Landscape: 731 x 580-676 x 265 mm
<b>Dimensions w/o stand (W x H x D)</b>	Portrait: NA Landscape: 731 x 485 x 141 mm
<b>Dimensions packaged (W x H x D)</b>	869 x 764 x 400 mm
<b>Net weight with stand</b>	26.9 kg
<b>Net weight w/o stand</b>	20.4 kg
<b>Net weight packaged with stand</b>	36.1 kg
<b>Net weight packaged w/o stand</b>	NA
<b>Height adjustment range</b>	96 mm
<b>Tilt</b>	-5° / +25°

<b>Swivel</b>	-45° / +45°
<b>Pivot</b>	NA
<b>Mounting standard</b>	VESA (100 mm)
<b>Screen protection</b>	Protective, non-reflective glass cover
<b>Recommended modalities</b>	CT, MR, US, DR, CR, NM, Film
<b>Certifications</b>	UL 60601-1 1ST EDITION, CAN/CSA-C22.2 NO. 601.1-M90, IEC 60601-1 2ND ED:1988 + A1:1991 + A2:1995, IEC 60950-1:2001 1ST EDITION, CE - 89/336/EEC, CE - 93/42/EEC, DEMKO - EN 60601-1, CCC - GB9254-1998 + GB4943-2001 + GB17625.1-2003,, BSMI - CNS13438(95) + CNS14336(94), VCCI, FCC class B, ICES-001 Level B, KETI (eK) Level B, BSMI, MDD class IIb, FDA 510k, RoHS
<b>Supplied accessories</b>	Getting Started Guide Quick-Installation Sheet Video cables (2 x DVI Dual Link) Main cables (UK, European (CEBEC/KEMA), USA (UL/CSA; adaptor plug NEMA 5-15P), Chinese (CCC)) USB 2.0 cable External power supply
<b>Optional accessories</b>	NA
<b>QA software</b>	MediCal QAWeb
<b>Unit per pallet</b>	NA
<b>Pallet dimensions</b>	NA
<b>Warranty</b>	5 years
<b>Operating temperature</b>	0°C to 35°C (15°C to 30°C within specs)
<b>Storage temperature</b>	-20°C to 60°C
<b>Operating humidity</b>	8% - 70% (non-condensing)
<b>Storage humidity</b>	5% - 95% (non-condensing)
<b>Operating altitude</b>	3000 m

\* In dark reading room conditions (0 lux)

# Warranty statement

## BARCO MID GENERAL WARRANTY TERMS AND CONDITIONS

Applicable from Jan 1st 2008

### ARTICLE 1: PRODUCT WARRANTY

Barco nv, Medical Imaging Division warrants that the equipment will be free of defects in workmanship or material for the warranty period or the specific period of a warranty extension program.

Hardware: Barco warrants that upon delivery hereunder the Products shall (i) conform to its specifications in effect at the date of delivery and (ii) be free from defects in material and workmanship (the "Warranties").

Software: Barco warrants that software written by Barco shall perform substantially in accordance with the specifications in effect at the date of delivery. Software is inherently susceptible to bugs and errors. Barco makes no warranties with respect to the software which is provided to Customer on an "as-is" basis and does not warrant uninterrupted or error-free operation of the Products.

Unless otherwise indicated in Barco's Product manual or in the agreement between Barco and Customer, the Warranty Period shall be

(a) Hardware: 12 months commencing on the Barco date of invoice.

(b) Software: 3 months commencing on the Barco date of invoice.

Notwithstanding the provisions of clause 2, repair and replacement of defects in material and/or workmanship under this warranty shall be accomplished in our works according to the terms and conditions as set forth hereafter:

1.1 Any claim under the Warranties must be notified to Barco in writing within 8 days from the date the defect or failure has been discovered or noticed the first time. The Customer, upon the occurrence of any equipment failure, shall contact Barco nv, MID customer support centre (or an authorised service centre) by telephone, fax or e-mail and shall provide the applicable customer support person with a complete description of the problem being encountered, including the model and serial number of the equipment in which the problem has arisen.

1.2 The customer support person shall diagnose the problem experienced by the Customer and shall advise the Customer on how to proceed. Customer support may ask to return the faulty equipment or faulty subassemblies to the Barco nv, or a MID customer support centre (or an authorised service centre) for repair activities. In no event shall Customer return a defective Product or part thereof to Barco without Barco's prior written approval.

In the event the return to Barco of the defective Product is authorized by Barco, Barco shall issue to Customer an RMA (Return Material Authorization).

The Customer shall apply for an RMA number to the closest Barco nv, MID Customer support centre (or an authorised service centre) as listed at [www.barcomedical.com](http://www.barcomedical.com), unless otherwise indicated.

The one-way cost of packing, transport and insurance related to shipping the alleged defective Product or part to Barco for repair or replacement shall be borne by Customer. The one-way cost of packing, transport and insurance related to shipping of the repaired or replacement Product or part to Customer shall be borne by Barco.

1.3 The Customer shall return, freight prepaid, the defective equipment or subassemblies in its original packaging with the assigned RMA number for repair to the Barco nv, MID Customer support centre (or an authorised service centre).

1.4 Replacement parts used shall be new or equivalent to new parts for the revision level of the equipment. A replacement LCD panel will be new or similar run time. The warranty period for the replacement parts will expire at the same moment as the original warranty period of the equipment. All parts replaced hereunder and returned to Barco nv, MID (or an authorised service centre) shall become the property of Barco nv, MID (or the authorised service centre).

1.5 The repaired equipment shall be returned to the Customer, by regular freight, at Barco nv, MID's charge.

1.6 Barco nv, MID will replace a product that fails within 90 days after shipment from Barco with a new one, ensuring color matching in the event of a diagnostic multi head display configuration.

Barco aims to ship the new replacement product within 2 business days after receipt of the Customers notification in writing.

### ARTICLE 2: CONDITIONS PRECEDENT FOR WARRANTY AND ITEMS EXCLUDED FROM WARRANTY

- A. The Warranties shall apply only to the extent the Products or any parts thereof have
- (i) been transported and stored at all times in the original packaging in the conditions as specified by Barco (such as covered and secure location, minimum and maximum temperature, maximum humidity, ...) or, in absence thereof, at least in conditions consistent with generally accepted practice for this type of products;
  - (ii) been handled at all times in accordance with Barco's instructions or, in absence thereof, at least with the care and caution consistent with generally accepted practice for this type of products;
  - (iii) been installed strictly in accordance with the instructions and directions given by Barco (if and to the extent the

- Products have not been installed by Barco or its authorized subcontractors);
- (iv) not been subject to any unauthorized access, alteration, modification or repair or attempts thereto;
  - (v) been at all times "normally used" for the intended purpose and operated in strict accordance with the operating instructions set forth in the operating manual of the Product in question and shall not have been otherwise misused, abused, damaged. For the purpose hereof, "normally used" shall mean a regular, ordinary and routine usage of the Product in question as intended and/or recommended by Barco;
  - (vi) been maintained at all times in accordance with Barco's instructions or, in absence thereof, at least with intervals and in a manner consistent with generally accepted practice for this type of products;
- B. The warranty described herein shall not include the following:
- 2.1 Any hardware or software item procured from a source other than Barco nv, MID or their official agent or distributor and integrated by Customer or a third party into Barco nv, MID supplied equipment.
  - 2.2 Any host configuration not explicitly supported by Barco nv, MID.
  - 2.3 All software installed on the system, whether they are acquired from Barco nv, MID or third party. An exception is made for software delivered by Barco nv, MID that would prove to be a cause for the mal functioning of the hardware covered under this Agreement.
  - 2.4 Normal wear and tear, use under circumstances exceeding specifications, such as use in dusty environment or under excessive temperature conditions, abuse, unauthorised repair or alteration, lack of proper configuration or maintenance, damaged or modified or removed serial number, cosmetic refurbishment.
  - 2.5 Repair or replacement of consumables<sup>1</sup> or specific parts that by definition are subject to wear and tear, including but not limited to:
    - a. CRT's, LCD panels
    - b. Backlights in diagnostic LCD displays, when the backlight run time<sup>2</sup> is beyond the Guaranteed Backlight Lifetime<sup>3</sup> of that model, when used at the Factory Calibrated Luminance<sup>4</sup>
      - Eg1.
        - A display is used at 8 hours/day; ie. +/-2.920hours/year
        - The display system is covered with a warranty period of 5 year
        - The Guaranteed Backlight Lifetime of that model is 17.000hours.
        - The Factory Calibrated Luminance cannot be achieved anymore after 4 year, thus corresponding to +/- 11.680hours
        - Result: the backlight replacement is performed under warranty
      - Eg2.
        - A display is used at 24 hours/day; ie. 8.760hours/year
        - The display system is covered with a warranty program of 5 year
        - The Guaranteed Backlight Lifetime of that model is 17.000hours.
        - The Factory Calibrated Luminance cannot be achieved anymore after 2.5years, thus corresponding to +/- 21.900hours
        - Result: the backlight replacement does not make part of the warranty coverage.
    - (1): 'Consumable' is a part that can be replaced by the user
    - (2): 'Backlight run time' is the total time that an image (including use of a screen saver) has been applied to the screen; this value can be consulted via the OSD buttons (On Screen Display).
    - (3): 'Guaranteed Backlight Lifetime' is the number of backlight hours during which a predefined luminance value, ie. the Factory Calibrated Luminance, will be provided by a specific diagnostic display model. This figure is printed on the Warranty certificate of each display or can be requested at your local Barco office.
    - (4): 'Factory Calibrated Luminance': is the typical luminance value that a specific diagnostic display model is calibrated at during the production process. This figure is printed on the Warranty certificate of each display or can be requested at your local Barco office.
  - c. Lamps, optical components in projectors
  - d. Replacement because of:
    - i. image retention as a result of:
      - not correctly using screen saver and/or Display Power Management System (DPMS) as explained in the user manual
      - prolonged operation of the display with a static image on the same screen area
    - ii. a number of missing pixels that is lower than the total allowable number as mentioned in the product specifications.

- iii. difference in color temperature that is lower than the total allowable difference as mentioned in the product specifications
- iv. difference in color temperature as a result of not using all displays of a multi-head configuration at the same rate.
- v. LCD luminance uniformity that is in within the product specifications or luminance uniformity performance that is inherent to LCD technology.

Barco nv, MID does not warrant a minimum life time nor a performance of any of the consumables.

- 2.6 Replacement of moveable parts such as power cords, remote controls, ...
- 2.7 Any product disassembly and installation costs at the operation site, travel expenses and travel time to and from the operation site for the personnel in charge of the repair works and transport charges.
- 2.8 Any failures resulting from an accident, negligence (such as but not limited to removing or deleting system files & licensed software product files), misuse, circuit failure or any change, damage due to fire, water, thunder or lightning, power failure or fluctuation, disruption of communication lines or due to force majeure, or any reason foreign to the equipment.
- 2.9 Any specific services or procedures, asked for by Customer, related to verification of repaired equipment.
- 2.10 The evaluation cost in case of a returned product deemed functional is not covered under warranty and will be charged to the Customer, at Barco's sole discretion, based on a case-by-case evaluation.

### **ARTICLE 3: OBLIGATIONS OF THE CUSTOMER**

Customer hereby assumes the following obligations as partial consideration for Barco nv, MID performance of its requirements under the warranty condition; failure by Customer to meet its obligations under this paragraph shall excuse Barco nv, MID's performance hereunder:

- 3.1 Customer shall not expose Barco nv, MID personnel to any unsafe working conditions.
- 3.2 Repairs to equipment under warranty resulting from improper maintenance or repair performed by the Customer, or its officers, agents, employees, or representatives, shall be borne by the Customer at its additional cost and expense.
- 3.3 The Customer is responsible for installing the Barco nv, MID equipment in an environment for which it was intended. If there is an indication that the equipment was used – even temporary – outside its specifications, Barco nv, MID is entitled not to perform warranty repairs and terminate the warranty agreement. Any actions that have been taken by Barco nv, MID in this respect, may be invoiced to the Customer at normal pricing.

### **ARTICLE 4: REMEDIES UNDER WARRANTY**

- (a) Hardware: If during the Warranty Period a Product or any part thereof, fails to meet any of the Warranties then, upon Customer's request, Barco shall, at its sole option and cost, promptly and within 20 working days, either: (i) repair or correct the Product or part in question; or (ii) replace the Product or supply part(s) or component(s) according to the terms and conditions contained in article 1. A replacement part shall be at least functionally equivalent to the original part. The replaced Product, parts and/or components shall become the property of Barco and shall, at Barco's request, be returned by Customer to Barco at Barco's cost.
- (b) Software: Barco's sole obligation shall be to rectify substantial malfunctions of the software (to the extent technically reasonably possible) by amending the software or supplying an alternative version of the software.
- (c) The repair or replacement under the Warranties covers the cost of material and labor.

### **ARTICLE 5: DISCLAIMER OF WARRANTIES**

BARCO NV, MID DISCLAIMS ALL WARRANTIES, EXPRESSED OR IMPLIED, INCLUDING ALL IMPLIED WARRANTIES OF MERCHANTABILITY AND FITNESS FOR A PARTICULAR PURPOSE.

### **ARTICLE 6: LIMITATION OF LIABILITY**

The remedies specified in these Terms and Conditions shall constitute Customer's sole and exclusive remedy and Barco's sole and exclusive liability for Barco's breach of the Warranties hereunder.

BARCO NV, MID SHALL NOT UNDER ANY CIRCUMSTANCES BE LIABLE TO CUSTOMER OR ANY THIRD PARTY FOR DIRECT, INDIRECT, INCIDENTAL, SPECIAL OR CONSEQUENTIAL DAMAGES, SUCH AS BUT NOT LIMITED TO, DAMAGE TO OR LOSS OF TANGIBLE OR INTANGIBLE PROPERTY OR EQUIPMENT, LOSS OF PROFITS OR REVENUES, COST OF CAPITAL, COST OF PURCHASE OF REPLACEMENT GOODS, OR CLAIMS OF USER FOR SERVICE INTERRUPTIONS. THE LIABILITY OF BARCO NV, MID FOR MANUFACTURING, SALE, DELIVERY, RESALE, INSTALLATION, OPERATION OR SUITABILITY FOR USE OF ANY PRODUCTS OR SERVICES COVERED BY OR FURNISHED UNDER THIS WARRANTY CONDITION, WHETHER ARISING OUT OF CONTRACT, NEGLIGENCE, STRICT TORT, WARRANTY OR OTHERWISE, SHALL NOT EXCEED THE PRICE OF THE ITEM OR ITEMS OF GOODS OR SERVICES UPON WHICH SUCH LIABILITY IS BASED.

### **ARTICLE 7: FORCE MAJEURE**

Either party shall be released from performance of its obligations under this agreement to the extent, and for so long as, the performance of this agreement is impeded by reason of force majeure. For the purposes of this clause the

expression "force majeure" means, but shall not be limited to, industrial dispute, fire, mobilisation, requisition, embargo, currency transfer prohibitions, insurrection, lack of means of transport, restrictions of the use of energy, and generally any circumstances which are beyond the control of the parties and hinder performance by one party of his obligations.

**ARTICLE 8: GENERAL**

8.1 Customer acknowledges its understanding that all software and electronic devices, including Barco nv, MID products are subject to possible error, mechanical or electrical failure, and should not be relied upon in inappropriate applications or without proper backup and/or other safety precautions whenever personal injury or property damage may result from failure or error of the product.

8.2 Barco nv, MID shall not be responsible for machine failure and/or its failure to render service or maintenance due to causes beyond its reasonable control.

(This page intentionally left blank.)

**K5902015-07**  
October 2011

**CE**  
**0120**

**Barco n.v.**  
President Kennedypark 35  
8500 Kortrijk  
Belgium  
[www.barco.com](http://www.barco.com)