



# intuos<sup>®</sup>.4



## User's manual for Windows<sup>®</sup> & Macintosh<sup>®</sup>

Using a pen

Customizing your pen

Troubleshooting

Using a tablet

Customizing your tablet

Digital inking

Using a cordless mouse

Customizing your cordless mouse

Using the Radial Menu

Application-specific settings

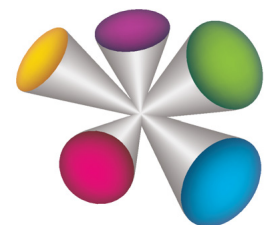

Intuos<sup>®</sup> 4

User's Manual for Windows<sup>®</sup> & Macintosh<sup>®</sup>

Version 2.0, Rev G2209

Copyright © Wacom Co., Ltd., 2009

All rights reserved. No part of this manual may be reproduced except for your express personal use. Wacom reserves the right to revise this publication without obligation to provide notification of such changes. Wacom does its best to provide current and accurate information in this manual. However, Wacom reserves the right to change any specifications and product configurations at its discretion, without prior notice and without obligation to include such changes in this manual.

The above year indicates when this manual was prepared. However, the date of release to the users of the "manual" is simultaneous with the introduction into the market of the applicable Wacom product.



**Reuse, recycling, and recovery.** You are urged to recycle this product when replacing it with a newer product or when it has outlived its useful life by bringing it to an appropriate collection point for recyclable materials in your community or region. By doing this, you can help improve the environment of your community as well as minimize the potential negative effects created should any hazardous substance that may possibly be present within waste material reach the environment during the disposal process.

Within the European Union, users are required not to dispose of Waste Electrical and Electronic Equipment (WEEE) as unsorted municipal waste, according to the Directive 2002/96/EC of the European Parliament and of the Council of 27 January 2003, or the corresponding local laws of the Member States. Products for which this is applicable will be marked with the WEEE symbol shown at the beginning of this note unless this is not feasible because of the size or the function of the product. Wacom products are subject to the Directive 2002/96/EC and therefore you should always collect them separately and bring them to the appropriate collection point in your community or region.

Wacom professional pen tablet products comply with the European Union RoHS Directive 2002/95/EC (RoHS Directive).

Tool ID, QuickPoint, and DuoSwitch are trademarks, and Intuos and Wacom are registered trademarks of Wacom Co., Ltd.

Adobe, Reader, and Photoshop are either registered trademarks or trademarks of Adobe Systems Incorporated in the United States and/or other countries. Microsoft, Windows, and Vista are either registered trademarks or trademarks of Microsoft Corporation in the United States and/or other countries. Apple, the Apple logo, and Macintosh are registered trademarks of Apple Computer, Inc., registered in the U.S. and other countries. Any additional company and product names mentioned in this documentation may be trademarked and/or registered as trademarks. Mention of third-party products is for information purposes only and constitutes neither an endorsement nor a recommendation. Wacom assumes no responsibility with regard to the performance or use of these products.

ExpressKey is a registered trademark of Ginsan Industries, Inc., and is used with permission.



## CONTENTS

About the manual	5	Tablet to screen mapping	36
Navigating the manual	6	Orientation	38
<b>WORKING WITH INTUOS4</b>	7	Screen area	38
Tablet features	8	Force proportions	39
Input tools and accessories	10	Tablet area	40
Setting up your work area	11	Mapping to multiple monitors	41
Using the Grip Pen	12	Button functions	42
Holding the pen	12	Using and customizing the Radial Menu	47
Pointing	13	Working with Display Toggle	48
Clicking	14	Working with multiple tools	50
Dragging	14	Application-specific settings	51
Using the side switch	15	Creating an application-specific setting	52
Drawing with pressure sensitivity	16	Changing application-specific settings	53
Drawing with tilt	16	Removing application-specific settings	53
Erasing	17	<b>TROUBLESHOOTING</b>	54
Eye-hand coordination exercise	17	Testing your tablet	55
Using the Intuos4 Mouse	18	Testing your tools	56
Working with the tablet	19	Testing a pen	57
Configuring the tablet orientation	20	Testing the Touch Ring	58
USB cable installation	20	Testing the ExpressKeys	58
Understanding the tablet active area	21	Testing the mouse	59
Using the ExpressKeys	22	Troubleshooting tables	60
Using the Touch Ring	23	General problems	60
<b>CUSTOMIZING</b>	24	Windows-specific problems	63
Opening the control panel	24	Macintosh-specific problems	64
Control panel overview	25	Technical support options	66
Control panel settings	26	Obtaining driver downloads	67
Customizing the pen	27	<b>APPENDIX</b>	68
Adjusting tip feel and double-click	28	Caring for your tablet and tools	68
Adjusting eraser feel	29	Replacing the pen tip	69
Advanced tip and eraser pressure settings	29	Uninstalling the software	70
Customizing tool buttons	30	Managing your tablet preferences	70
Customizing tilt sensitivity	31	Changing the tablet mode	71
Customizing the mouse	31	Installing multiple tablets	71
Customizing the mouse buttons	32	Advanced options	72
Customizing the tablet functions	33	Optimizing the ExpressKeys display	73
Customizing the ExpressKeys	34	Using applications integrated for tablet control	73
Customizing the Touch Ring	35	Using the optional Airbrush and Art Pen	74





Intuos4 Lens Cursor	75	Radio and television interference	88
Customizing the lens cursor	76	FCC notice	88
Testing the lens cursor	76	Industry Canada (Canada only)	88
Working with AutoCAD	77	CE declaration	89
Configuring AutoCAD for		Precautions	90
a Wintab compatible digitizer	77	Warnings	90
Configuring tablet menus and		Cautions	90
screen pointing areas in AutoCAD	78	License and Warranties	
Calibrating Intuos4 for AutoCAD	79	(Worldwide, Except for Europe,	
Pen and digital ink capabilities in Windows Vista	80	Africa and Middle East)	91
About the Windows Vista Tablet PC Input Panel	81	Software License	91
Product specifications	82	Limited Warranty (U.S.A. and Canada)	91
General specifications for all Intuos4 tablets	82	Warranty Service in the U.S.A. and Canada	92
Intuos4 S tablet (model PTK-440)	82	Warranty on Sales Outside of	
Intuos4 M tablet (model PTK-640)	82	the U.S.A. and Canada	93
Intuos4 L tablet (model PTK-840)	83	Licence warranty conditions	
Intuos4 XL tablet (model PTK-1240)	83	(Europe, Africa and Middle East)	94
Intuos4 Grip Pen (model KP-501E)	83	Software Licence Agreement	94
Intuos4 Mouse (model KC-100)	83	Limited Warranty	95
Intuos4 Airbrush (model KP-400E)	83	GLOSSARY	97
Intuos4 Inking Pen (model KP-130)	84	INDEX	100
Intuos4 Art Pen (model KP-701E)	84		
Intuos4 Classic Pen (model KP-300E)	84		
Intuos4 Lens Cursor (model KC-210)	84		
Product information	85		
Ordering parts and accessories	85		
Available parts and accessories	86		



## ABOUT THE MANUAL

This manual provides quick access to information about Intuos4. The information is common to Windows and Macintosh computers and Windows screen captures are shown, unless otherwise noted.

- Go directly to a [contents](#) or [index](#) topic by clicking on it.
- [Working with Intuos4](#) is the learning chapter. It describes the various tablet features and functions of each Intuos4 tool, and includes exercises for new users.
- [Customizing](#) describes how you can change the control panel settings to optimize your Intuos4 tablet and tools for the way you like to work.
- Want to test your tablet and tools? Need troubleshooting guidelines? [Troubleshooting](#) is where you will find the answers to most common questions.
- The [appendix](#) includes tips on caring for your tablet and tools, a how-to on uninstalling the software, your license and warranty, and more. Also included are tips on working with AutoCAD, as well as an overview of the pen and [digital inking](#) capabilities found in Microsoft Windows Vista.

**Note:** This manual does not describe how to install your Wacom tablet. Please refer to your product Quick Start Guide and to the automated software installer (located on the Intuos installation CD) for details.

If you are new to electronic documentation, read [navigating the manual](#).

- SMALL CAPITAL LETTERS are used to identify the names of keyboard keys, dialog boxes, and control panel options.
- You can use your viewer zoom-in tool to increase the size of the manual on your display screen.
- The following information is not included with this product: information about your specific computer hardware or operating system, or information about your application software. Your best source for this information is the set of manuals and discs that came with your hardware, operating system, or application.
- Many applications have built-in support for Intuos4 features (such as pressure sensitivity, tilt, and the pen eraser). For information on how best to use these and other Intuos4 features within a specific application, see the instructions in that application's manuals. See also [product information](#).

Wacom's philosophy is to continually improve all of its products. As a result, engineering changes and improvements are made from time to time. Therefore, some changes, modifications, and improvements may not be covered in this manual.



## NAVIGATING THE MANUAL

Use the navigation controls to move through the manual.



Go to front page.

**Contents**

Go to table of contents.

**Index**

Go to index.



Go back to previous view.



Page back, or page forward.

[topic](#)

Go to topic.



Topic continued.

Adobe® Reader® provides additional tools for using and printing the manual. See the Adobe Reader help for more information.





## WORKING WITH INTUOS4

This section introduces you to the Intuos4 professional pen tablet. Intuos4 consists of two basic elements: a tablet that serves as your work area, and the [input tools](#) you use on the tablet.

If you are new to using a pen tablet and tablet input tools, read the following sections.

[Tablet features](#)

[Input tools and accessories](#)

[Setting up your work area](#)

[Using the Grip Pen](#)

[Using the Intuos4 Mouse](#)

[Working with the tablet](#)



# TABLET FEATURES

## Status LEDs

An LED will glow dimly when power is on, and brighten when a tool button is pressed. LEDs also indicate which of the four Touch Ring functions is active.

## Touch Ring

Includes toggle button at center of ring.

## ExpressKeys

Intuos4 M tablet shown.

Intuos4 S tablet models are equipped with six ExpressKeys, and do not include the ExpressKeys display.

## ExpressKeys display

Shows the current ExpressKey settings.

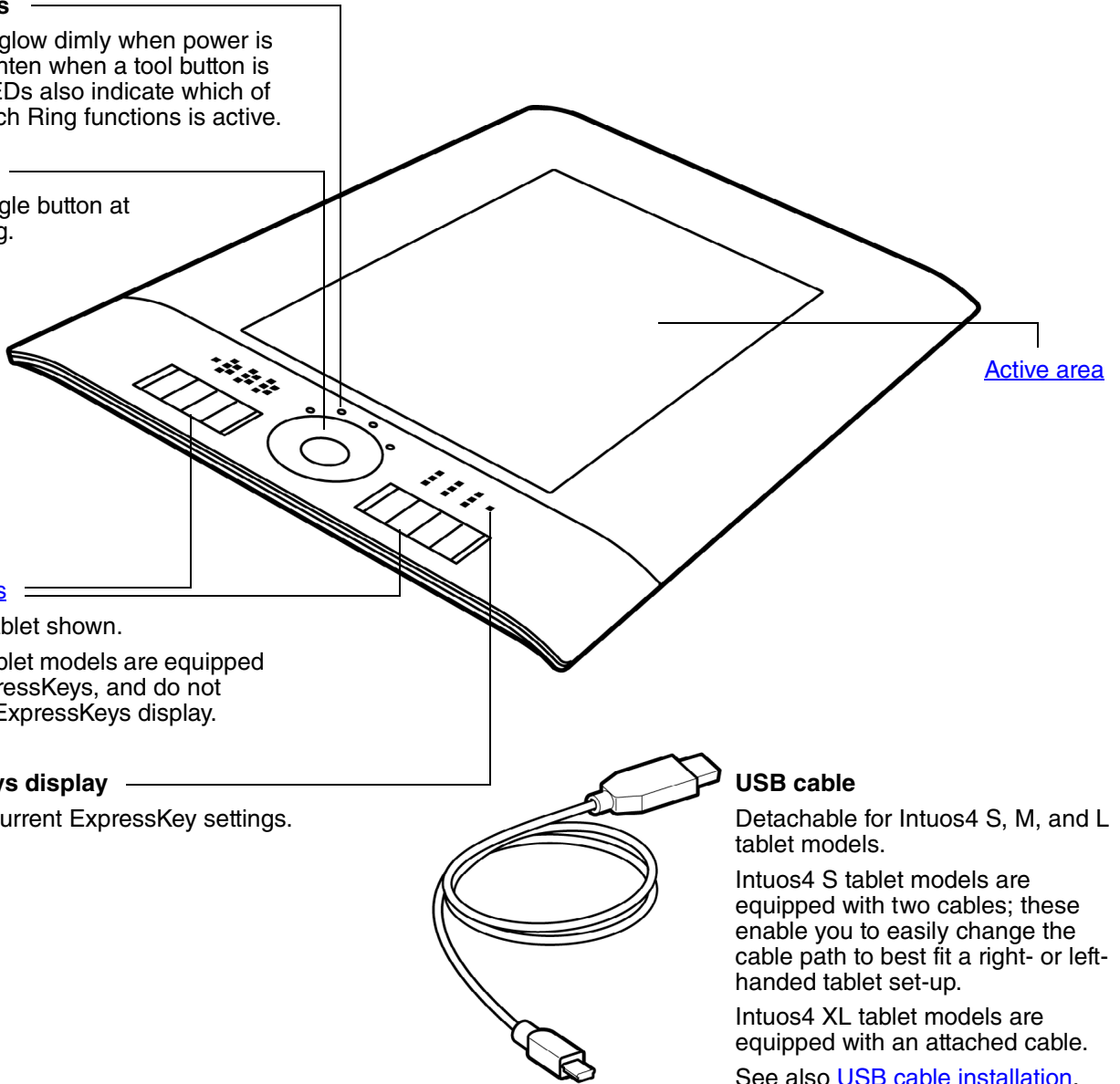

Active area

## USB cable

Detachable for Intuos4 S, M, and L tablet models.

Intuos4 S tablet models are equipped with two cables; these enable you to easily change the cable path to best fit a right- or left-handed tablet set-up.

Intuos4 XL tablet models are equipped with an attached cable.

See also [USB cable installation](#).





**USB port**

For right-handed configuration. Intuos4 M and L tablet models only.

**USB port access cover**

Slide this cover to access the USB port that applies to your operating configuration. See [configuring the tablet orientation](#).

**Important:** Intuos4 S tablet models have only one USB port and no access cover. Intuos4 XL models do not have a USB port and are equipped with an attached USB cable.

**USB port**

For left-handed configuration. Intuos4 M and L tablet models only.

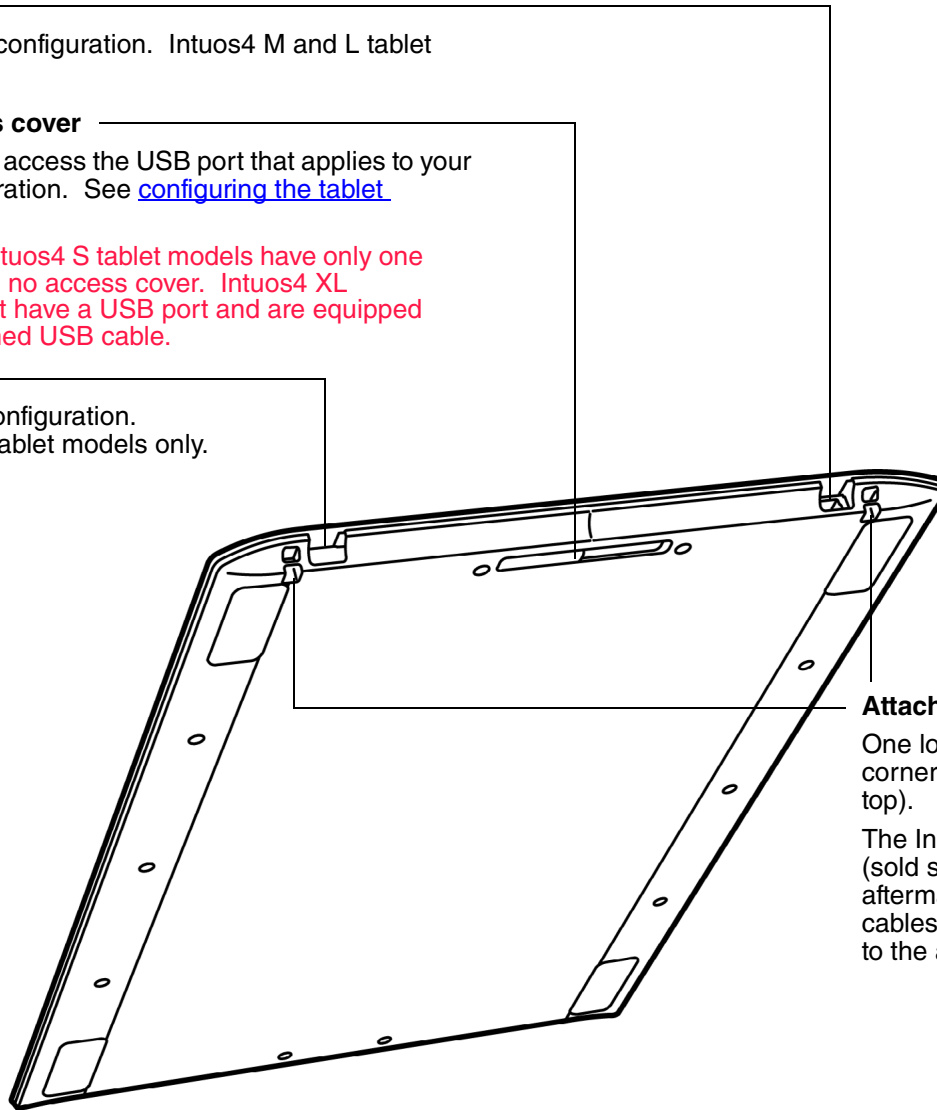

**Attachment points**

One located on each corner (not visible from top).

The Intuos4 pen tether (sold separately) or aftermarket security cables can be connected to the attachment points.

## INPUT TOOLS AND ACCESSORIES

All Intuos4 input tools are cordless and battery free. Each tool features a unique [Tool ID](#), which enables you to work with multiple tools and to customize each tool differently.

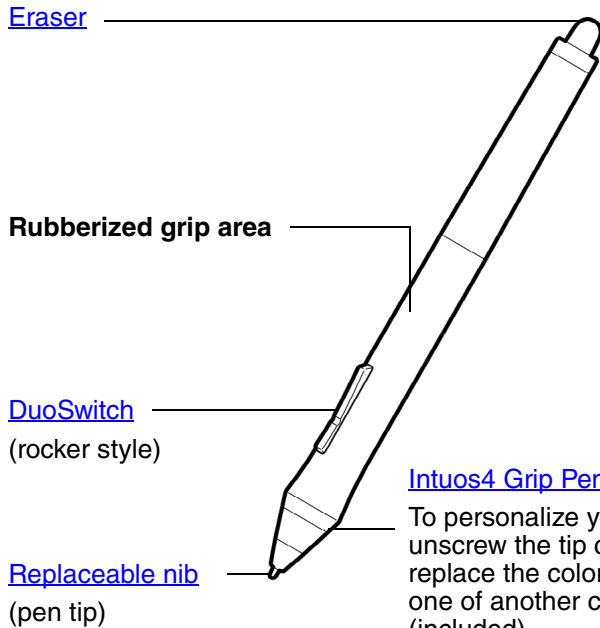

**Intuos4 Grip Pen**  
To personalize your pen, unscrew the tip cone and replace the colored ring with one of another color (included).

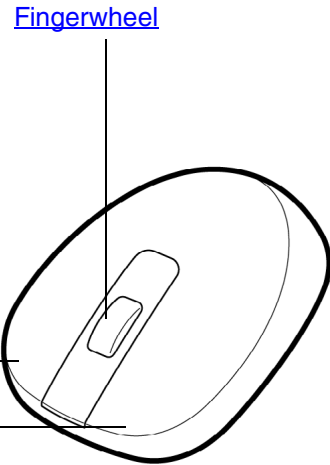

**Intuos4 Mouse**  
**Notes:**

- Product configurations may vary.
- Some product configurations may not include the mouse.
- Some Intuos4 XL tablets may come equipped with the [Intuos4 Lens Cursor](#) instead of the Intuos4 Grip Pen.

**Pen stand**  
Unscrew the base to access a nib extraction tool and assorted replacement nibs.

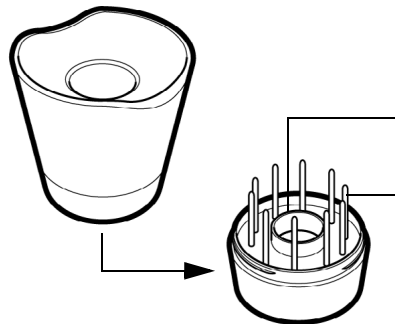

**Nib extractor**  
**Replacement nibs**

- 5 standard nibs, black
- 1 flex nib, white and black
- 1 stroke nib, white
- 3 hard felt nibs, gray

See [available parts and accessories](#) for information on additional input tools and accessories.

## SETTING UP YOUR WORK AREA

To minimize fatigue, comfortably organize your work area. Position your tablet, input tools, and keyboard for easy access without unnecessary reaching. Position your monitor so you can view it with a minimum of eyestrain. For best results, position the tablet so the screen cursor follows the same direction as your hand movements on the tablet.



- Take short breaks between tasks to stretch and relax your muscles.
- Use a gentle grip when working with your tools.
- Alternate tasks and tools throughout the day.
- Maintain a good posture at all times. Minimize awkward postures and repetitive movements that cause discomfort.
- Change your position if you feel any discomfort due to your work position.

For right-handed use, position the tablet so the drawing (active) area is located to the right of the ExpressKeys. For left-handed use, position the tablet with the drawing area to the left of the ExpressKeys. See [configuring the tablet orientation](#) for details.

**Note:** Wacom makes no representation, promise or guarantee that Wacom products will cure or prevent, in whole or in part, mouse-induced repetitive stress symptoms, injuries or conditions. Individual results may vary. Always obtain competent medical advice to determine the most appropriate treatment for your specific situation.

## USING THE GRIP PEN

There are four basic techniques for using the pressure-sensitive pen on the active area of the tablet: pointing, clicking, double-clicking, and dragging. If you are unfamiliar with using the pen, try the exercises on the following pages.

[Holding the pen](#)

[Pointing](#)

[Clicking](#)

[Dragging](#)

[Using the side switch](#)

[Drawing with pressure sensitivity](#)

[Drawing with tilt](#)

[Erasing](#)

[Eye-hand coordination exercise](#)

## HOLDING THE PEN

Hold the Grip Pen like you would a normal pen or pencil. Make sure the DuoSwitch is in a convenient location where you can toggle it with your thumb or forefinger, but not accidentally press the switch while drawing or navigating with the pen. Tilt the pen in any way that feels most comfortable.

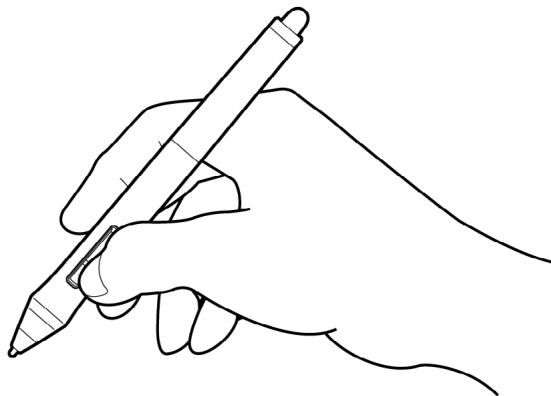

Position for drawing and navigating

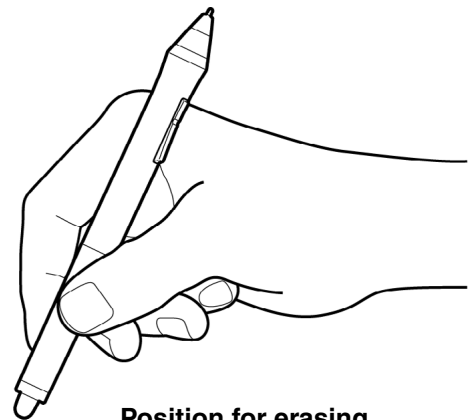

Position for erasing

Place the pen stand within easy reach of your tablet. The stand allows for vertical or horizontal placement of the pen.

**Important:** When the pen is not in use, place it in the pen stand or lay it flat on your desk. To maintain the sensitivity of your pen, do not store the pen in a container where it will rest on its tip or eraser.

Leaving an Intuos4 tool on the tablet may interfere with screen cursor positioning when using other pointing devices, or may prevent your computer from going to sleep.

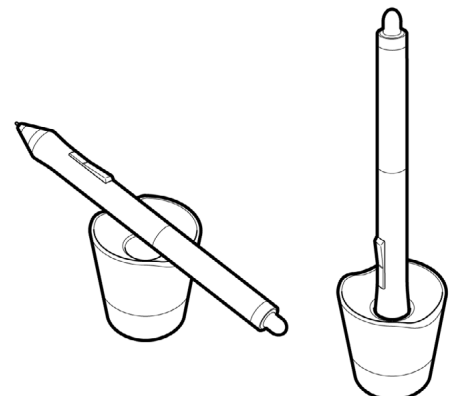

## POINTING

The Intuos4 pen positions the pointer (or cursor) on your screen.

Move the screen cursor by lifting the pen and placing the pen tip in a new location on the tablet active area. The cursor instantly jumps to the new location.

See [understanding the tablet active area](#).

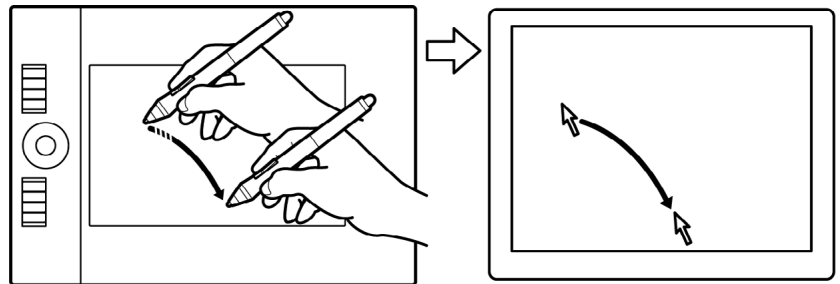

To select an icon or folder, use your pen to position the screen cursor over the object. Press down to select.

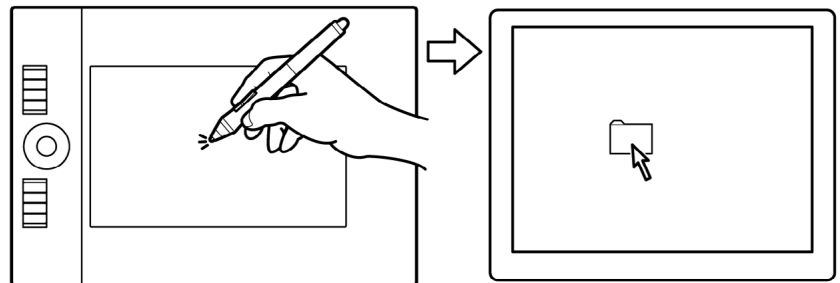

### Hints:

- If you find that using a pen is somewhat difficult, try the [eye-hand coordination exercise](#).
- Pointing is easier when you orient the tablet so the screen cursor follows the same direction as your hand movements on the tablet.

You can position the screen cursor two different ways: like a pen ([PEN MODE](#)) or like a mouse ([MOUSE MODE](#)).

- In [PEN MODE](#), the tablet active area is a mapped representation of your computer screen; wherever you place the pen on the tablet, the screen cursor will jump to a corresponding point on the display screen. This is the default setting for the pen.
- In [MOUSE MODE](#), the default setting for the Intuos4 Mouse, you move the cursor with a “pick up and slide” action similar to using a traditional mouse.

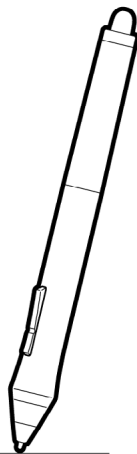

10 mm (0.39 inch)

When using the pen, the pen tip needs to be within 10 mm (0.39 inch) of the tablet surface. The pen tip does not need to touch the tablet in order to move the screen cursor or use the side switch.

All Intuos4 tools, including the Intuos4 Mouse, work only over the active area of the tablet.

## CLICKING

Click to highlight or select something on the screen. Double-click to open it.

**Clicking.** Tap the pen tip once on the tablet, or press the pen tip on the tablet with enough force to register a click. (There is no audible pen tip “click” sound.) Try clicking on a folder icon by moving the screen cursor over the icon and pressing down on the pen tip. The folder should highlight when you press.

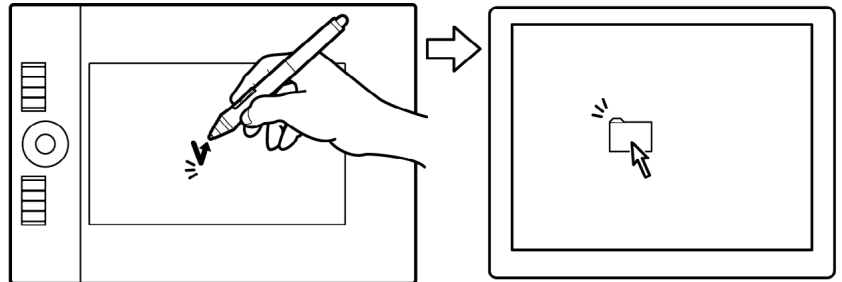

**Hint:** You can configure Windows to select when the pen is over an icon and to launch the icon with a single click. To turn on this feature, first open a folder.

- **Windows Vista:** From the ORGANIZE pull-down menu choose FOLDER AND SEARCH OPTIONS.... From the GENERAL tab select SINGLE-CLICK TO OPEN AN ITEM (POINT TO SELECT).
- **Windows XP:** From the TOOLS pull-down menu choose FOLDER OPTIONS.... From the GENERAL tab select the option SINGLE-CLICK TO OPEN AN ITEM (POINT TO SELECT).

**Double-clicking.** Quickly tap the tablet twice in the same place with the pen tip. This is like clicking twice with a mouse button. Try double-clicking on a folder icon to open it.

**Hint:** Press the upper side switch to double-click. This is easier than tapping twice with the pen tip.

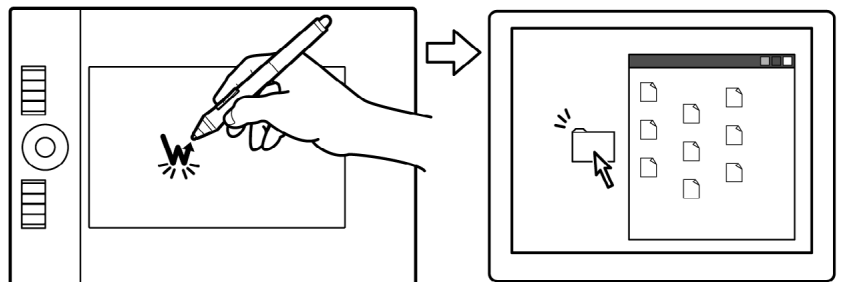

## DRAGGING

To drag, first point to an object. Then press the pen tip to the tablet and slide it across the tablet surface. The selected object will move across the monitor or display screen.

To select text within a document, move the screen cursor to the beginning of a text line, then drag the pen across the tablet to highlight the text.

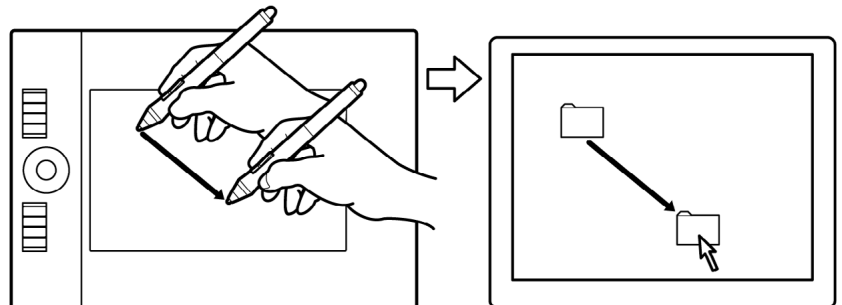



## USING THE SIDE SWITCH

The DuoSwitch on the Intuos4 Grip Pen has two programmable [functions](#) that can be selected by rocking the switch in either direction.

**Note:** You can use the DuoSwitch whenever the pen tip is within 10 mm (0.39 inch) of the tablet active area – you do not have to touch the pen tip to the tablet in order to use the switch.

The default switch positions are:

Upper: DOUBLE CLICK

Lower: RIGHT CLICK

**Double-clicking.** Press the upper side switch to double-click. This is easier than tapping twice with the pen tip.

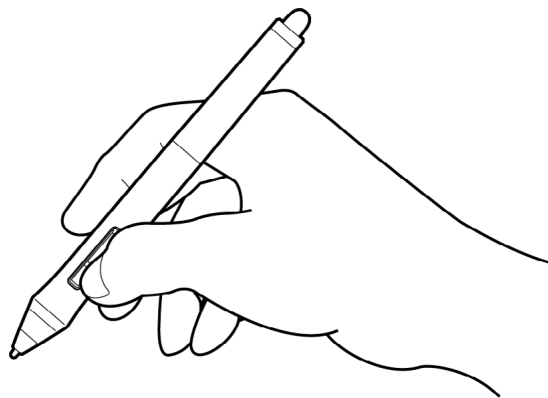

**Right-clicking.** Press the lower pen switch to bring up application-specific or icon-specific menus.

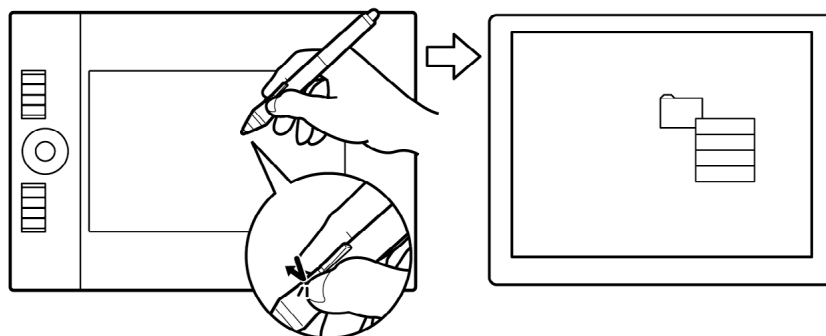

To assign new switch functions, see [customizing tool buttons](#).



## DRAWING WITH PRESSURE SENSITIVITY

The Intuos4 pen responds to your hand movements, enabling you to create natural-looking pen and brush strokes. Many graphics applications have drawing tools that respond to the pressure you place on the pen. The [digital ink](#) tools in Microsoft Windows Vista and Office 2007 also respond to the pressure you place on the pen.

To draw with pressure sensitivity, first select a pressure-sensitive tool from your application's tool palette. Then draw along the surface of the tablet while applying various amounts of pressure downward on the tip of the pen.

Press hard for thick lines or dense color, and press gently for thin lines or softer color.

To adjust the tip feel, see [adjusting tip feel and double-click](#).

Visit our web site for a list of applications that support pressure. See [product information](#).

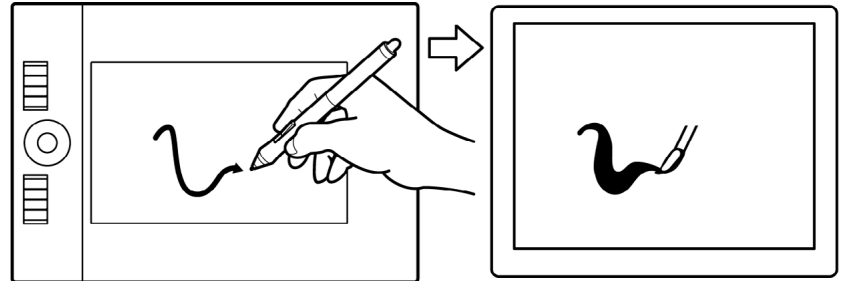

## DRAWING WITH TILT

The tablet recognizes when you tilt the pen from vertical to inclined positions. In some drawing applications, tilt can be used to control line shape and thickness. This is like working with an airbrush where tilt can be used to make a line thin when the tool is vertical, or wide when the tool is tilted. In other applications, you can adjust tilt to define brush characteristics such as width, color, and opacity.

To test tilt, draw a curve in a graphics application (such as Painter™) that supports tilt. Be sure the tilt function in your application is active, then change the tilt of the pen as you draw to vary the shape and thickness of the brush stroke.

As an example, when the brush shape dynamics in Adobe Photoshop have been configured for tilt operation, tilting the pen results in an elongated pattern.

This simulates the effects of an airbrush spray that is angled away from the paint surface.

To adjust the amount of pen tilt required to produce a desired tilt effect in your application, see [customizing tilt sensitivity](#).

Visit our web site for a list of applications that support tilt. See [product information](#).

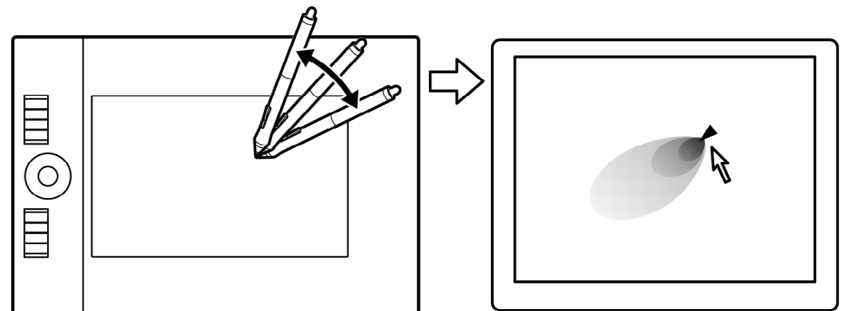



## ERASING

The Intuos4 pen eraser works like the eraser on a pencil.

You can erase intuitively and naturally in graphics applications that support the pen eraser. When you use the pen eraser, the application will automatically switch to the eraser tool.

In applications that support pressure sensitivity, you can select pressure-sensitive tools in the application's tool palette to vary the width and depth of your erasures as you change the amount of pressure you exert upon the pen.

See [adjusting eraser feel](#) for more information.

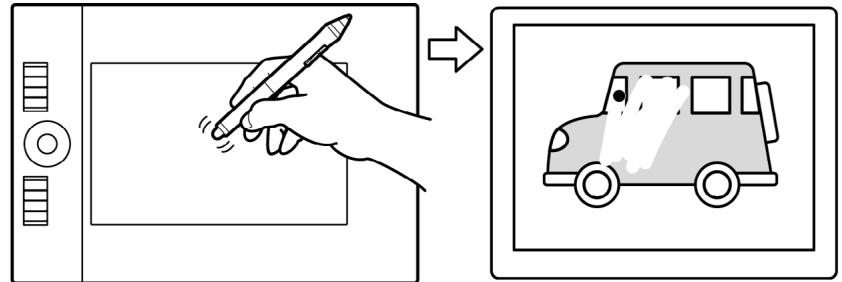

For Microsoft Windows Vista and Office 2007, you can use the eraser to erase notes or sketches made with [digital ink](#), and to select and delete text or spreadsheet cells within an application.

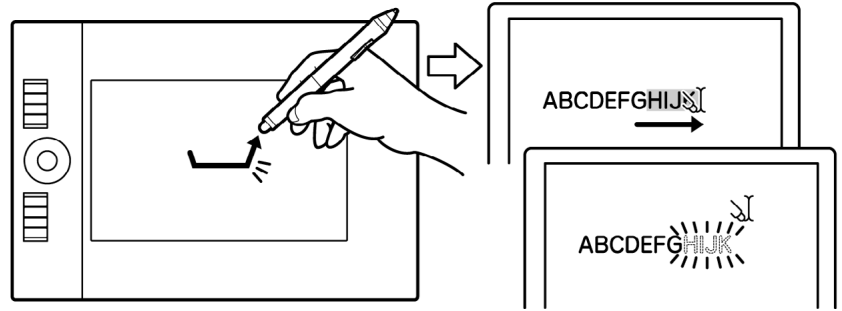

Visit our web site for a list of applications that support the eraser (see [product information](#)). If the eraser is not supported in an application, you can still use the eraser for navigating, drawing, or annotation.

## EYE-HAND COORDINATION EXERCISE

This exercise is designed to retrain your eye-hand coordination for using the pen:

1. Open any graphics application. Use the line tool to draw a rectangular grid with line spacings of about 20-25 mm (3/4 to 1 inch). You can use your traditional mouse to do this.
2. Choose a free-hand tool in your application and use the pen to draw a dot at each grid intersection.
3. Draw an X at each grid intersection.
4. Now draw a circle around each intersection. Your screen should look like this:

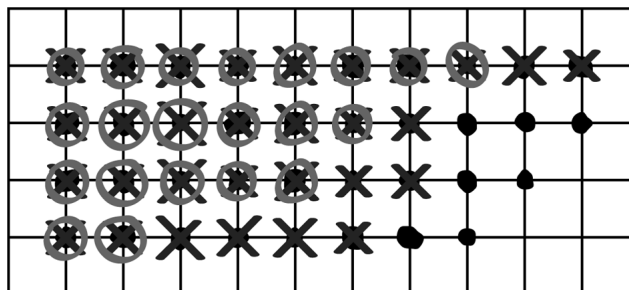

5. Clear your screen and make a simple drawing of your own. The more you use your pen, the easier drawing and navigation will become.

## USING THE INTUOS4 MOUSE

The Intuos4 Mouse is cordless, battery free, and works on any Intuos4 tablet. Some product configurations may not include the mouse.

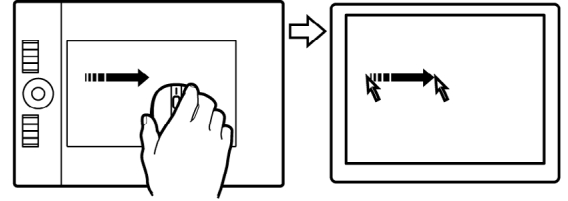

### Fingerwheel

Can be rolled, or pressed for an additional button function.

- Roll the fingerwheel to scroll in most windows and applications. Move the wheel forward to scroll up, and back to scroll down.

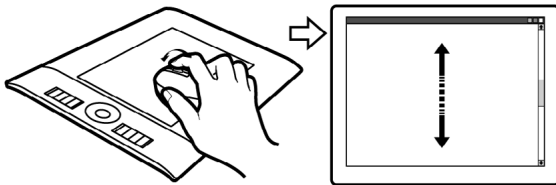

- Press down on the wheel to perform a MIDDLE CLICK.

**Hint:** For Microsoft Office applications that support a wheel mouse, press the CTRL key and move the fingerwheel to zoom in and out.

### Right button

Displays a context menu when pressed.

### Left button

This is the primary button used to CLICK and select.

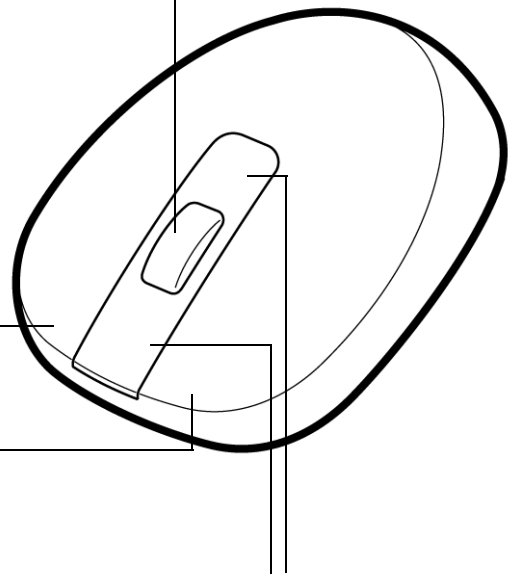

### Front and rear buttons

These are set for FORWARD and BACK functionality within your Internet browser.

The default mouse button positions are:

Left:	CLICK
Right:	RIGHT CLICK
Middle:	MIDDLE CLICK
Front:	FORWARD
Rear:	BACK

**Important:** When the Intuos4 Mouse is not in use, place it on your desk. Leaving an Intuos4 tool on the tablet may interfere with screen cursor positioning when using other pointing devices, or may prevent your computer from going to sleep.

See also [customizing the mouse](#).

## WORKING WITH THE TABLET

The middle section of the tablet is the working, or active, area for the pen or mouse. Wherever you place your pen on the tablet active area, the screen cursor will jump to a corresponding point on the screen. See [using the Grip Pen](#) and [using the Intuos4 Mouse](#) for more information.

Intuos4 M tablet shown.

Intuos4 S tablet models are equipped with six ExpressKeys, and do not include the ExpressKeys display.

**Active area**

**ExpressKeys**

Press the customizable ExpressKeys to perform frequently used functions or keystrokes, or to emulate button clicks or modifier keys.

**Touch Ring**

Slide your finger around the ring to zoom, scroll, or perform other custom actions.

Press the toggle (center) button to toggle between four customizable states. As you toggle between settings, a corresponding status LED illuminates.

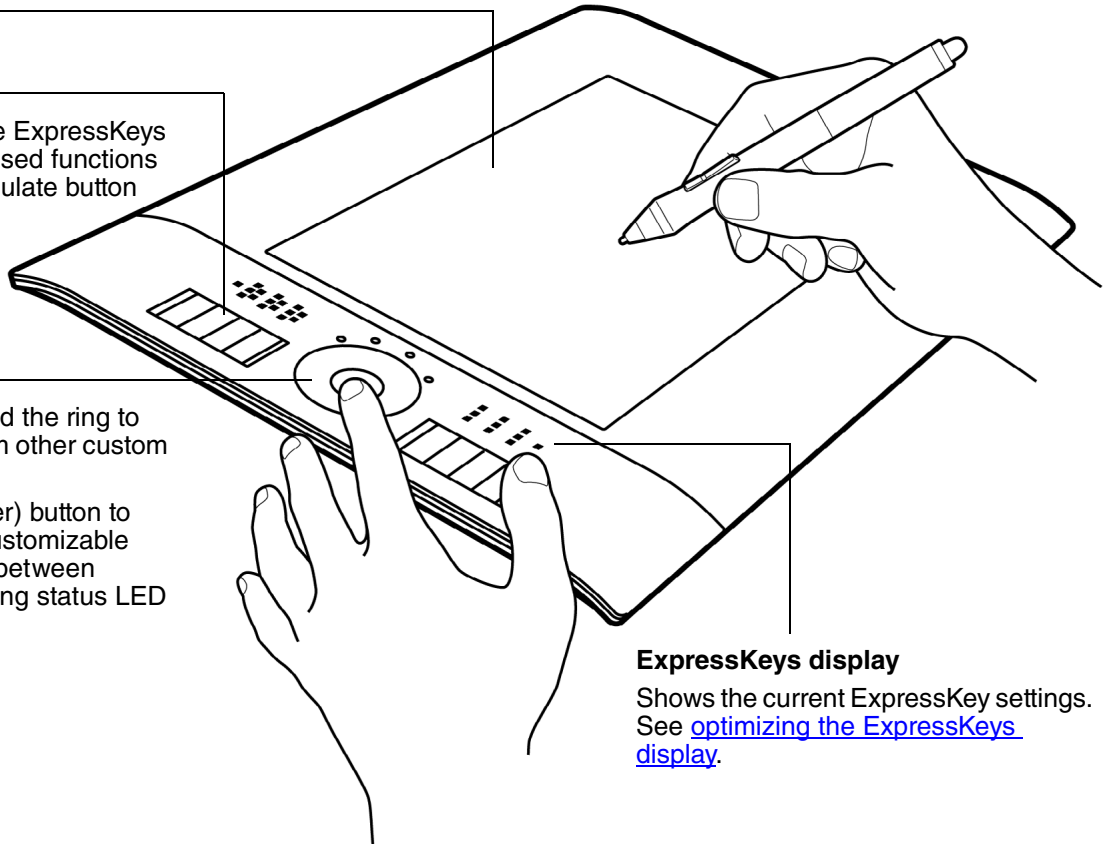

**ExpressKeys display**

Shows the current ExpressKey settings. See [optimizing the ExpressKeys display](#).

## CONFIGURING THE TABLET ORIENTATION

Set up Intuos4 as shown below for right- or left-handed operation.

### Tablet setup for right-handed operation

Open the Wacom Tablet control panel and select the MAPPING tab. Choose the EXPRESSKEYS LEFT [orientation](#) option – the tablet driver automatically configures all aspects of the tablet (including the Wacom Tablet control panel options) for correct right-handed use.

Next, physically rotate your tablet so the tablet ExpressKeys are positioned to the left. As desired, reconfigure the [USB cable installation](#).

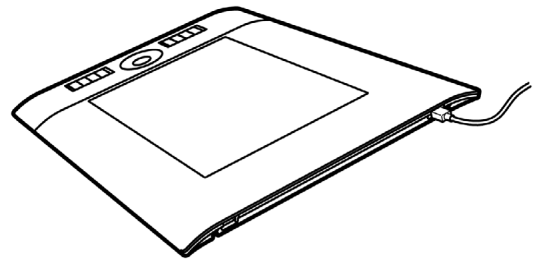

### Tablet setup for left-handed operation

Open the Wacom Tablet control panel and select the MAPPING tab. Choose the EXPRESSKEYS RIGHT [orientation](#) option – the tablet driver automatically configures all aspects of the tablet (including the Wacom Tablet control panel options) for correct left-handed use.

Next, physically rotate your tablet so the tablet ExpressKeys are positioned to the right. As desired, reconfigure the [USB cable installation](#).

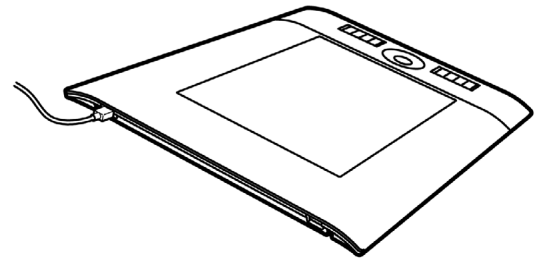

**Note:** You are prompted to choose a default tablet orientation when installing the tablet software from the Intuos installation CD. At the log-in and user switching screens, the tablet orientation will use the default setting selected when the driver was installed.

You can always change how your tablet is oriented using the above procedure. But if you want to change the tablet default orientation, you must re-install the driver from the Intuos installation CD.

## USB CABLE INSTALLATION

Depending on your tablet model, choose the [USB port](#) or cable routing solution that best applies to your operating configuration.

- For Intuos4 M or L tablet models, slide the USB port access cover to one side or the other. Then attach the USB cable.
- For Intuos4 S tablet models, select the right- or left-handed USB cable and attach it to the tablet port. Be careful to correctly match the cable connector to the tablet USB port.
- For Intuos4 XL tablet models, route the USB cable using the tablet cable guides.

Next, connect the other end of the USB cable to your computer.

Cable paths, Intuos4 S Right-handed use.

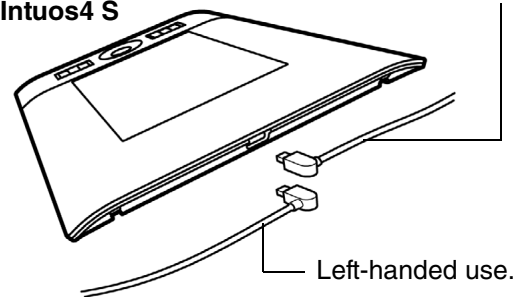

Left-handed use.

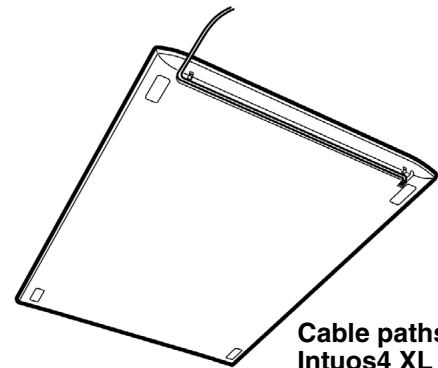

Cable paths, Intuos4 XL



## UNDERSTANDING THE TABLET ACTIVE AREA

The [active area](#) is the area of the tablet that senses pen movement.

Wherever you place the pen on the tablet, the screen pointer will jump to the corresponding point on the screen. This is the default setting for the pen.

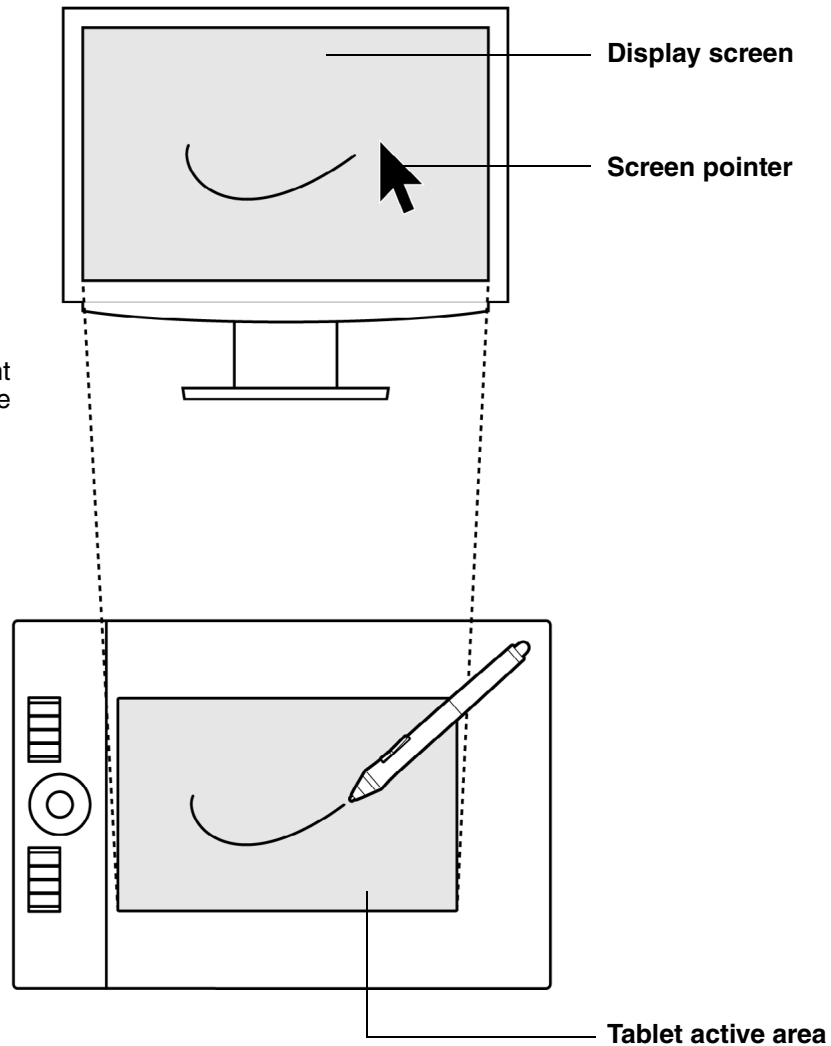

The screen pointer indicates pen position, and follows the movement of the pen across the tablet's active area.

Your Intuos4 input tools work only on the active area of the tablet.

**Note:** The tablet active area is a mapped representation of your computer screen(s), and by default uses the entire screen or all screens if you have multiple displays. To customize the mapping relationship, see [tablet to screen mapping](#).



## USING THE EXPRESSKEYS

ExpressKeys can be pressed individually or in combination with other ExpressKeys. They can also be used together with your Intuos4 input tools. This allows you to modify a tool property with your secondary hand while using the pen with your primary hand.

ExpressKeys configuration when positioned on the left side of the tablet (EXPRESSKEYS LEFT).

ExpressKeys configuration when positioned on the right side of the tablet (EXPRESSKEYS RIGHT).

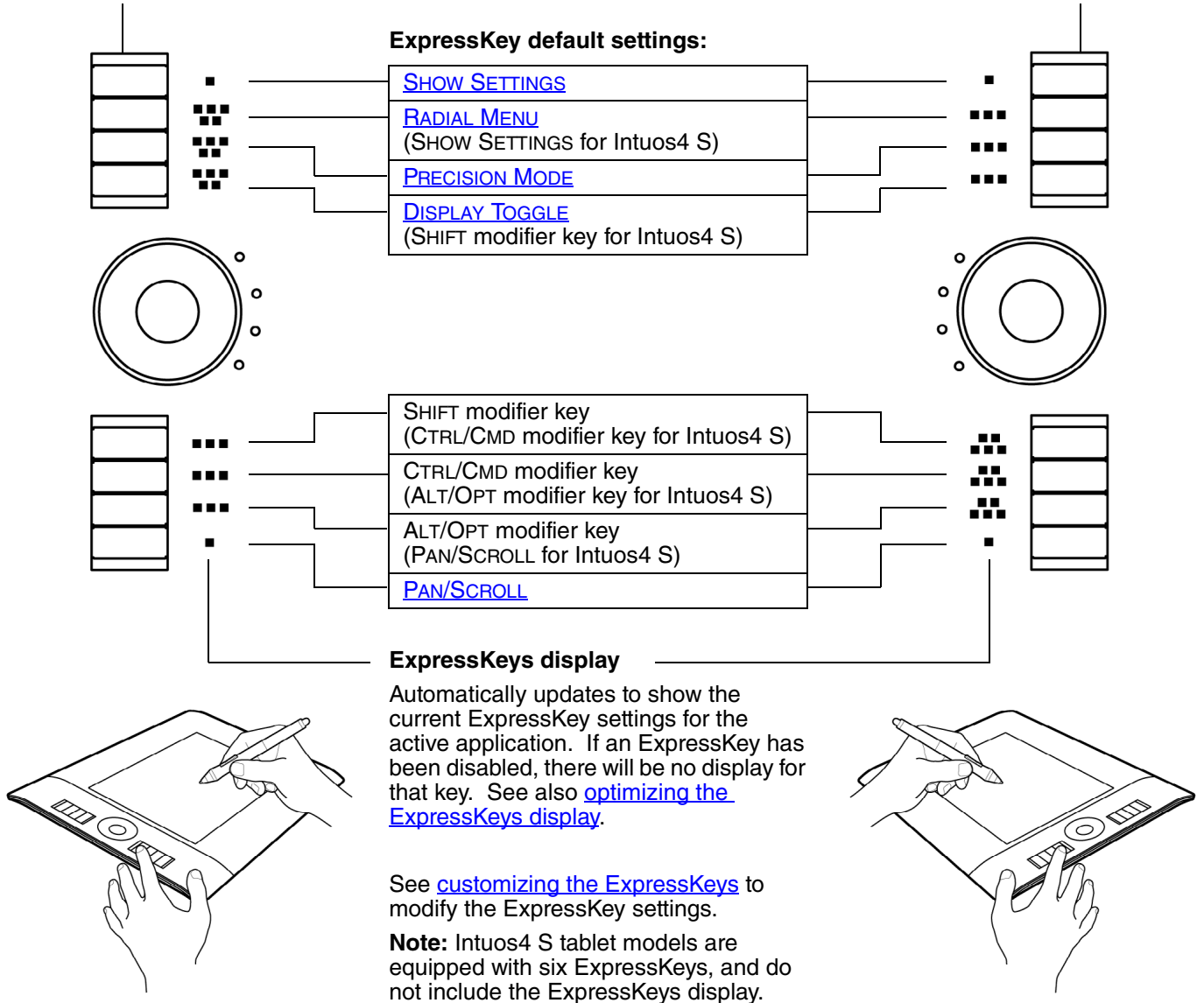

**Important:** Some applications can override and control the ExpressKey functions. For details, see [using applications integrated for tablet control](#).

**Tip:** In Adobe Photoshop and many other graphics applications, the ALT, CTRL, and SHIFT keys can be used to modify a tool (or switch to a complementary tool) while the key is pressed.

## USING THE TOUCH RING

Slide your finger around the ring to zoom in or out, scroll up or down, or to issue the assigned keystroke functions.

### Example of zooming in

Move your finger clockwise along the ring to zoom in or scroll down in most applications.

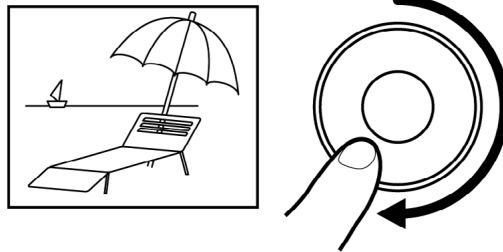

### Example of zooming out

Move your finger counter-clockwise to zoom out or scroll up.

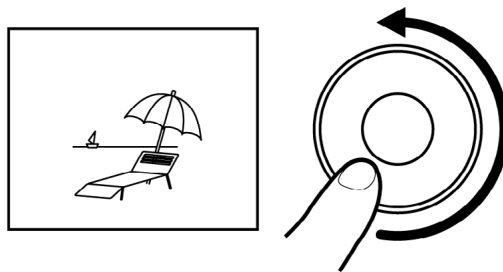

### Touch Ring default settings:

Press the toggle button to switch between four customizable states. As you toggle between settings, a corresponding status LED illuminates. Any disabled settings are skipped in the toggle sequence.

Intuos4 M tablet shown.

<p><b>Setting 1:</b> AUTO SCROLL/ZOOM. Sets the ring to zoom in most graphics applications and scroll in most other applications. Page scrolling is not supported.</p> <p><b>Note:</b> Some applications may interpret zoom events as scroll events, or may completely ignore zooming. Likewise, scroll events may be interpreted as zoom events, or ignored completely.</p>
<p><b>Setting 2:</b> KEYSTROKE... CYCLE LAYERS. Enables you to cycle up or down through a stack of layers when working in Adobe Photoshop. Move your finger clockwise along the ring to cycle up through layers.</p>
<p><b>Setting 3:</b> KEYSTROKE... BRUSH SIZE. Sets the ring to increase or decrease the brush size of your drawing tool when working in Adobe Photoshop.</p>
<p><b>Setting 4:</b> KEYSTROKE... CANVAS ROTATION. Enables you to rotate or flip an entire image when working in Adobe Photoshop. (Requires Adobe Photoshop CS4 or later.)</p>

See [customizing the Touch Ring](#) to modify the way your tablet Touch Ring works.

**Important:** Some applications can override and control the Touch Ring functions. For details, see [using applications integrated for tablet control](#).

## CUSTOMIZING

After you master the basics of using Intuos4, you may want to customize the way the tablet or input tools work. This chapter describes how to adjust your tablet and tool settings.

Advanced users can learn how to further optimize Intuos4 by creating [application-specific settings](#).

[Opening the control panel](#)

[Control panel overview](#)

[Control panel settings](#)

[Using and customizing the Radial Menu](#)

[Working with Display Toggle](#)

[Working with multiple tools](#)

[Application-specific settings](#)

### OPENING THE CONTROL PANEL

To open the Wacom Tablet control panel, use the Intuos4 tool you wish to customize on the tablet:

- **Windows.** Click on the Windows START button and choose ALL PROGRAMS. Then select WACOM TABLET and choose the WACOM TABLET PROPERTIES option.
- **Macintosh.** Open SYSTEM PREFERENCES from either the Dock, the Apple menu, or from the APPLICATIONS folder. Then click on the WACOM TABLET icon.

After opening the control panel, you can begin customizing Intuos4.

**Note:** User-specific preferences are supported. After logging in, each user can customize their personal settings in the Wacom Tablet control panel. Switching to another user will automatically load the settings for that user.



## CONTROL PANEL OVERVIEW

Use the Wacom Tablet control panel to customize your Intuos4 tablet or input tools.

The upper portion of the control panel displays icons representing your TABLET, TOOL, and the APPLICATION settings.

The screenshot shows the 'Wacom Tablet Properties' window. At the top, there are three tabs: 'Tablet' (set to 'Intuos4 M'), 'Tool' (set to 'Grip Pen'), and 'Application' (set to 'All'). Below these are three sub-tabs: 'Pen', 'Eraser', and 'Mapping'. The 'Pen' sub-tab is active, showing settings for 'Tilt Sensitivity' (Normal to High), 'Tip Feel' (Soft to Firm), 'Current Pressure' (Click to Full), and 'Click' (Double Click, Right Click, Tip Double Click Distance). A central image of the pen is shown with a 'Click' label. At the bottom are buttons for 'About', 'Options...', and 'Help'. A 'Default' button is also present near the 'Tip Double Click Distance' slider.

Choose FUNCTIONS to customize your ExpressKeys, Touch Ring, and [Radial Menu](#) settings.

Choose PEN to customize your Intuos4 pen settings.

Choose MOUSE to customize your Intuos4 Mouse settings.

Choose FUNCTIONS to customize your ExpressKeys, Touch Ring, and [Radial Menu](#) settings.

Choose PEN to customize your Intuos4 pen settings.

Choose MOUSE to customize your Intuos4 Mouse settings.

Choose MOUSE to customize your Intuos4 Mouse settings.

Returns the selected tab to its default settings.

Displays [advanced options](#).

Displays help options.

Experiment with different settings to find what works best for you. Any changes you make will take effect immediately. Click DEFAULT to return a tab to the factory settings.

Tool Tips are available for most control panel items. Position the screen cursor over an item and let it rest there; in a few moments the Tool Tip will pop up.

Your keyboard tab and arrow keys can be used to navigate the control panel.



**Control panel lists and tabs:** The control panel TABLET, TOOL, and APPLICATION lists allow you to select the tablet, tool, or application for which to change settings.

To change tool settings, open the control panel using the tool you wish to customize. The tool will be automatically selected in the TOOL list, and the appropriate tabs will be displayed.

To customize settings for a different tool, select it from the TOOL list by clicking on its icon (the appropriate tabs will be displayed). See [customizing the pen](#), [customizing the mouse](#), and [customizing the tablet functions](#) for more information.

The TABLET list displays an icon for any supported tablet that has been installed on your system. All settings shown below this list apply to the selected tablet.

The TOOL list displays an icon for the tablet FUNCTIONS, and for each Intuos4 tool that has been used on the tablet.

**Note:** When a new tool is first used on the tablet it is automatically added to the list, and functions with the default settings. See also [working with multiple tools](#).

The APPLICATION list lets you define tool settings that apply only to a specific application. See [application-specific settings](#).

See also [installing multiple tablets](#) and [changing the tablet mode](#).

**Note:** The APPLICATION list is for advanced users; it is not necessary to select or add applications in order to customize your Intuos4 tool(s).

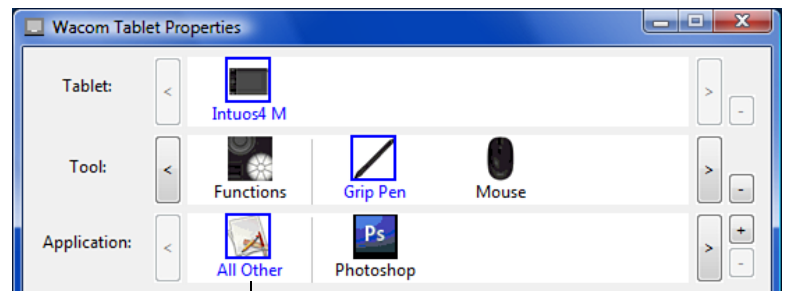

Your current selections are highlighted.

## CONTROL PANEL SETTINGS

The following sections provide detailed information about each control panel tab and some of the more difficult concepts. Many of the sections also contain useful customizing tips.

[Customizing the pen](#)

[Customizing the mouse](#)

[Customizing the tablet functions](#)

[Tablet to screen mapping](#)

[Button functions](#)



## CUSTOMIZING THE PEN

Use the pen to open the Wacom Tablet control panel. The pen will be selected in the TOOL list and the appropriate tabs will be displayed. Select a tab and choose from the available options.

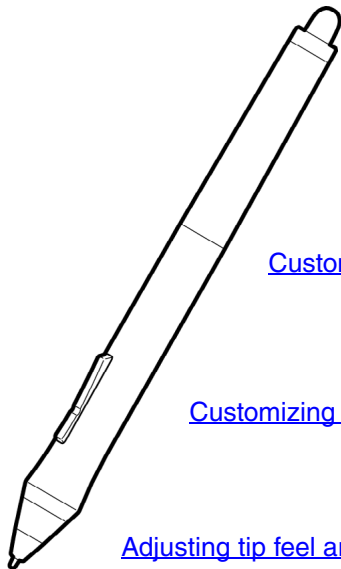

[Adjusting eraser feel](#)

[Customizing tilt sensitivity](#)

[Customizing tool buttons](#)

[Adjusting tip feel and double-click](#)

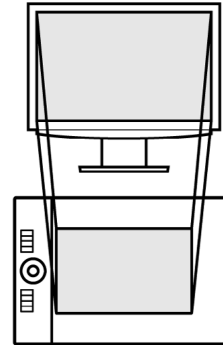

[Tablet to screen mapping](#)

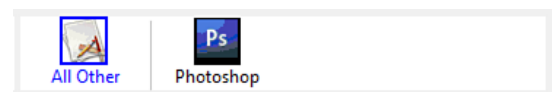

[Application-specific settings](#)



## ADJUSTING TIP FEEL AND DOUBLE-CLICK

Select the PEN tab.

Customizes the amount of pressure needed to click, draw, or ink.

Displays the tip [FEEL DETAILS](#) dialog box where you can further customize the tip sensitivity.

Press the pen tip on the tablet to test the TIP FEEL setting. Adjust the TIP FEEL so that you can comfortably reach full pressure.

Adjusts the size of the double-click area. Drag the slider to OFF to disable [double-click assist](#).

### Hints:

- Use a soft TIP FEEL to reach the full pressure range with a lighter touch.
- In some applications a soft pressure setting can make the pen overreact – any small press on the pen is magnified on the screen. If you experience this, try a firmer TIP FEEL setting.
- To make double-clicking easier, expand the tap area that accepts a double-click (the double-click distance).

**Note:** A large double-click distance may cause a delay at the beginning of brush strokes in some drawing applications. This may also cause a delay at the beginning of a drag action or inking stroke. If you notice such effects, try setting a smaller double-click distance or using the side switch to double-click (see [using the side switch](#)). You can also set an ExpressKey to double-click.

## ADJUSTING ERASER FEEL

Select the ERASER tab.

Select the [function](#) to perform when using the eraser.

Customizes the amount of pressure needed to erase.

Displays the eraser FEEL DETAILS dialog box where you can further customize the eraser sensitivity.

With your screen cursor positioned over an empty area of your desktop, press the pen's eraser on the tablet to test the ERASER FEEL setting. Adjust the ERASER FEEL so that you can comfortably reach full pressure.

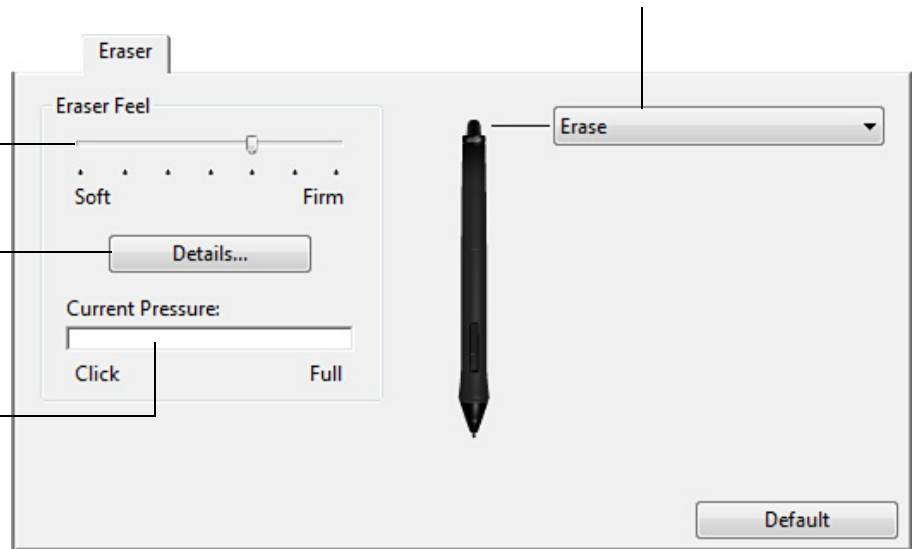

## ADVANCED TIP AND ERASER PRESSURE SETTINGS

To further customize tip or eraser pressure settings from the PEN or ERASER tab, click on the DETAILS... button. The options within the FEEL DETAILS dialog box enable you to change the tip or eraser pressure sensitivity and click threshold settings independently.

**Important:** In the PEN and ERASER tabs, these settings are adjusted simultaneously with the TIP FEEL or ERASER FEEL slider, which override the detailed pressure settings.

Drag the slider to select a pressure sensitivity setting.

If you have a soft touch, choose a softer setting.

Drag the slider to adjust the click threshold level.

This setting determines the amount of force required to generate a tip click.

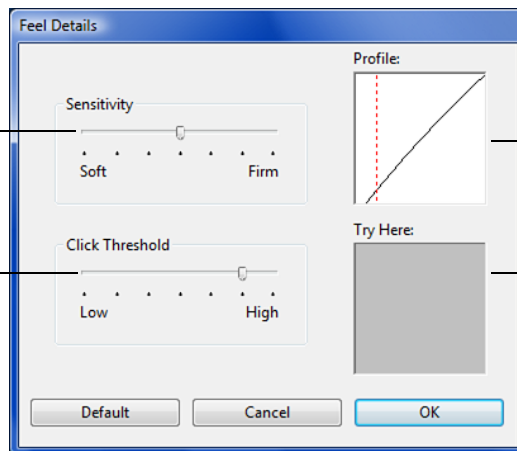

Graphically displays the selected pressure SENSITIVITY curve and CLICK THRESHOLD settings.

A curve that increases quickly makes the pen feel more sensitive.

Using your pen tip or eraser, make several strokes within the box to test the results of your changes.

## CUSTOMIZING TOOL BUTTONS

Select the PEN tab.

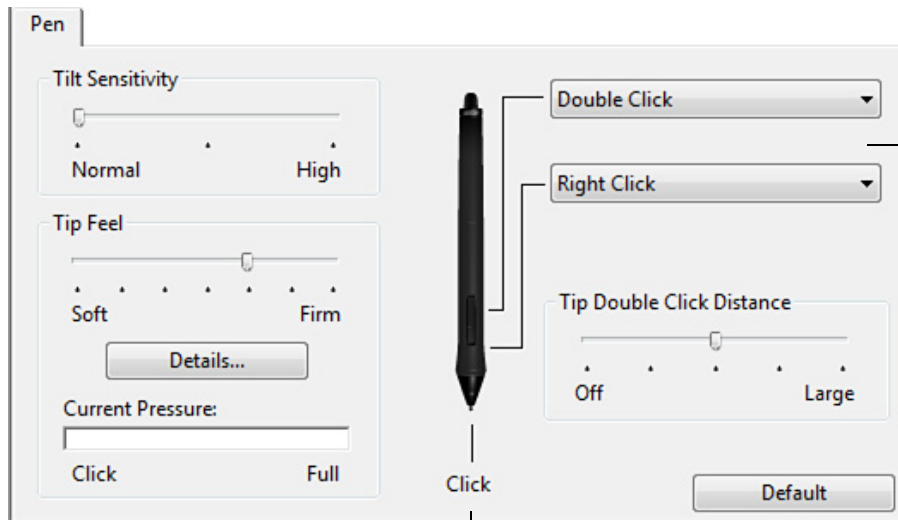

Select the [function](#) to perform when pressing the upper or lower side switch.

**Hint:** To make double-clicking easier, set the side switch to double-click automatically by selecting DOUBLE CLICK.

Double-click here to change the function assigned to the pen tip.

- At least one tool button should be set to the CLICK function.
- The tip must be set to CLICK in order to draw in most graphics applications.

**Note:** You can change how the side switch operates for right clicks or other click functions. See [advanced options](#) for details.

## CUSTOMIZING TILT SENSITIVITY

To adjust the tilt sensitivity of your Intuos4 pen, select the PEN tab.

Tilt sensitivity determines how far you must tilt the tool to produce the maximum tilt effect; you need to tilt the pen less at high sensitivity than at low sensitivity.

Drag the slider to increase or decrease TILT SENSITIVITY. Then test the new setting in an application that supports tilt. The tilt setting applies to both the tip and eraser of your tool.

**Note:** Tilt is direction-sensitive and can be used in some applications to control brush orientation or other characteristics.

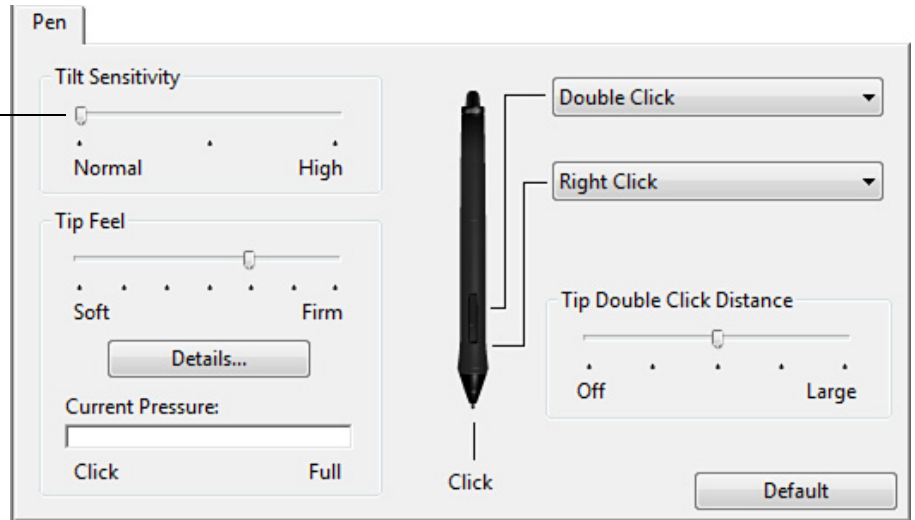

Visit Wacom’s web site for a list of applications that currently support tilt. See [product information](#).

## CUSTOMIZING THE MOUSE

Use the Intuos4 Mouse to open the Wacom Tablet control panel. The MOUSE tool will be selected in the TOOL list and the appropriate tabs will be displayed. Select a tab and choose from the available options. Some product configurations may not include the mouse.

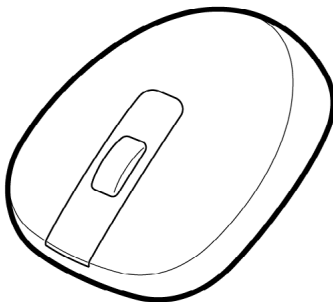

[Customizing the mouse buttons](#)

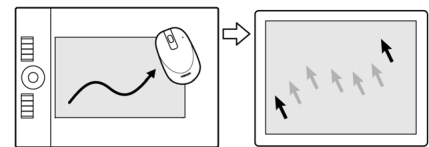

[Mouse mode settings](#)

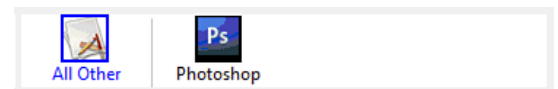

[Application-specific settings](#)

## CUSTOMIZING THE MOUSE BUTTONS

Use your Intuos4 Mouse to open the Wacom Tablet control panel and select the MOUSE tab.

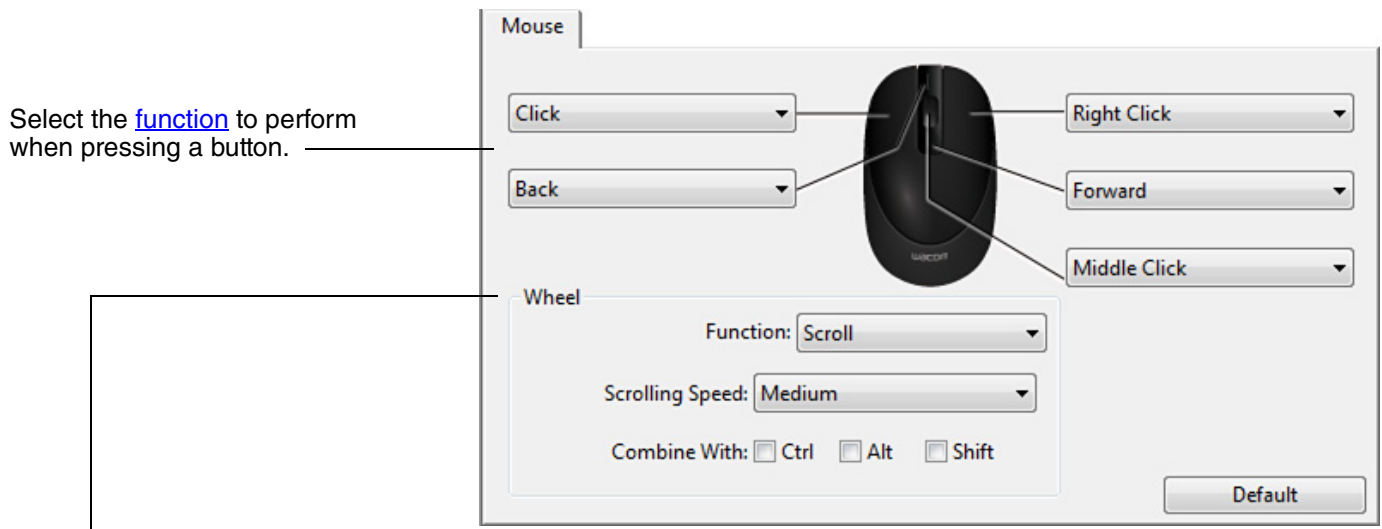

WHEEL options (SCROLL, KEYSTROKE, or DISABLED) control the fingerwheel function. The default setting is SCROLL.

**SCROLL** When selecting SCROLL, the tab displays custom scroll options. Choose a SCROLLING SPEED to use for each notch of wheel movement.

When you select one or more COMBINE WITH: modifier key options, the selected option(s) will be sent to the application along with each scroll event. For example, you can create custom zooming or other actions within an application.

**Macintosh:** The available options are OPTION, COMMAND (Apple key), CONTROL, and SHIFT.

**KEYSTROKE** Select the [KEYSTROKE](#) option to assign custom functions to the fingerwheel. This is useful when working with repetitive functions. Keystroke(s) that you define are sent once for each notch of wheel movement.

**Hint:** To double the speed of a keystroke action, enter the keystroke sequence twice within the DEFINE KEYSTROKE dialog box.

**DISABLED** Disables the wheel function.

The mouse buttons are chordable; you can press two or more buttons simultaneously. For example, if you program one button to simulate the CTRL key and another to simulate an ALT keystroke, when you press both buttons a CTRL+ALT is simulated.

**Note:** To configure the Intuos4 Mouse for left-handed use, simply reassign the button functions as needed. You can also open the Wacom Tablet control panel, click on OPTIONS... and select LEFT in the MOUSE HANDEDNESS group.



## CUSTOMIZING THE TABLET FUNCTIONS

To customize the ExpressKeys, Touch Ring, and other tablet features, open the Wacom Tablet control panel and select the FUNCTIONS icon in the TOOL list. Select a tab to customize, and change settings using the available options.

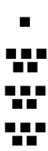

[Customizing the ExpressKeys](#)

[Customizing the Touch Ring](#)

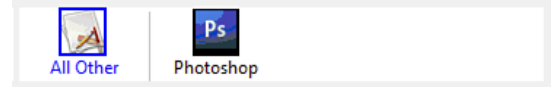

[Application-specific settings](#)

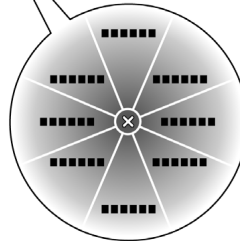
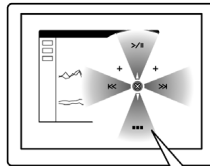
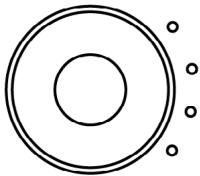

[Using and customizing the Radial Menu](#)

## CUSTOMIZING THE EXPRESSKEYS

When you open the EXPRESSKEYS tab, the current functions are shown in the corresponding pull-down menus. As an additional reference, the tablet ExpressKeys display provides a visual indication of the ExpressKey settings.

When using Intuos4, the ExpressKeys display automatically updates to show the key settings for the application that is currently in the foreground. If an ExpressKey has been disabled, there will be no display for that key.

**Note:** To set the brightness of the Touch Ring status LEDs and ExpressKeys display, select the OPTIONS... button located at the bottom of the control panel. In the OPTIONS dialog box adjust the EXPRESSKEY DISPLAY BRIGHTNESS slider as needed.

To customize a key, choose a [function](#) that will be performed when the key is pressed. The default settings are described in [using the ExpressKeys](#).

Intuos4 S tablet models are only equipped with six ExpressKeys, and do not include the ExpressKeys display.

**Note:** ExpressKey functions can be defined for use with [specific applications](#).

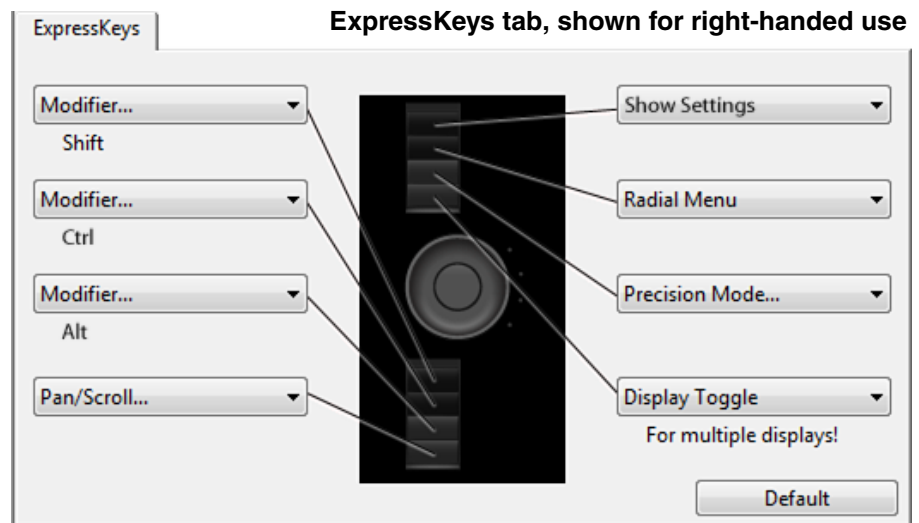

The ExpressKeys will be rotated 180 degrees when the tablet [orientation](#) is set to EXPRESSKEYS RIGHT.

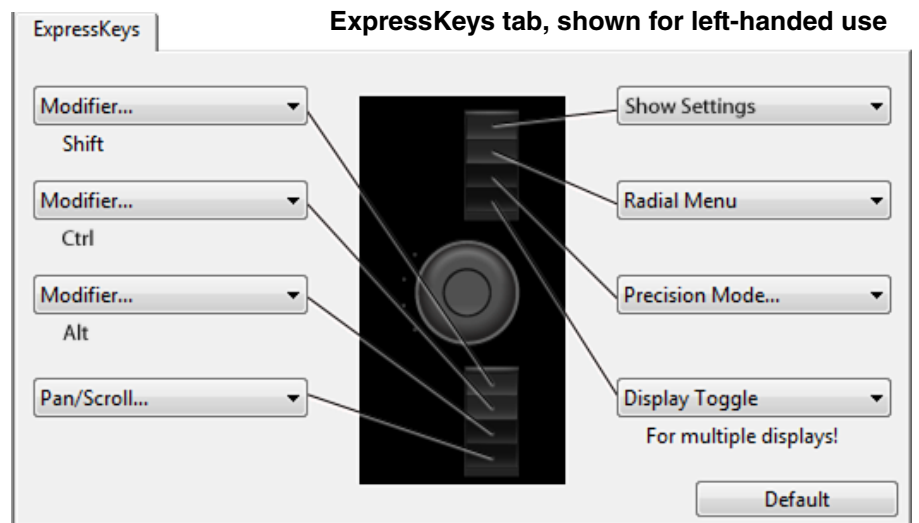

**Important:** Some applications can override and control the ExpressKey functions. For details, see [using applications integrated for tablet control](#).

## CUSTOMIZING THE TOUCH RING

When you select the tablet TOUCH RING tab, the currently set Touch Ring functions are displayed. You can customize the Touch Ring to issue zooming, scrolling, or custom keystroke actions.

**Note:** Touch Ring functions can be defined for use with specific applications. Any changes you make on this tab apply to the currently selected icon in the control panel's APPLICATION list.

The below control panel tab depicts a tablet configured for right-handed (EXPRESSKEYS LEFT) use.

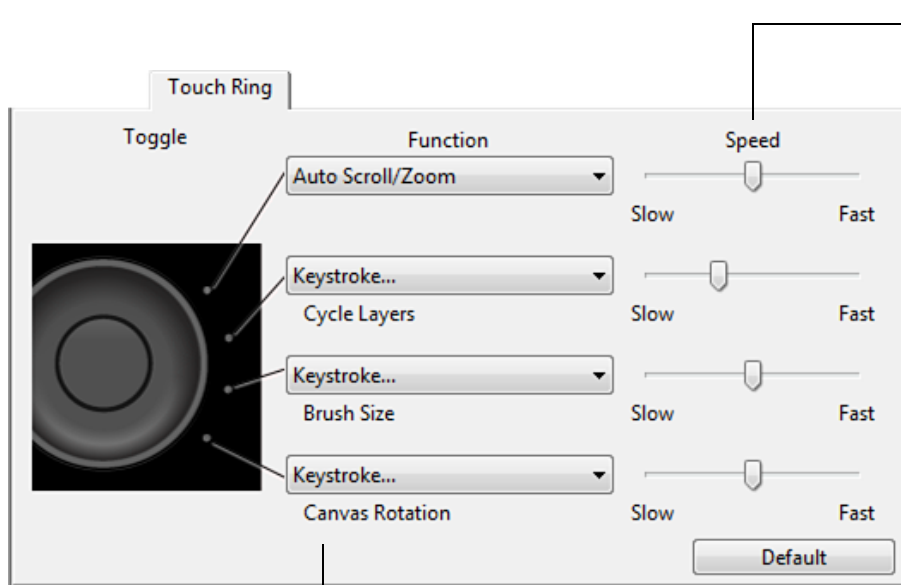

The SPEED setting can be customized for each function. This controls the rate at which zooming and scrolling occurs, or the speed at which keystroke events are sent to an application.

**Tip:** To zoom images around the current position of the screen cursor when working in Adobe Photoshop CS3 or later, open the Adobe Photoshop general preferences pane, check the ZOOM WITH SCROLL WHEEL option, and click OK.

Choose a function to perform when the ring is in use. Default settings are:

**AUTO SCROLL/ZOOM**

Sets the Touch Ring to zoom in most graphics applications and scroll in most other applications. Page scrolling is not supported.

Move your finger clockwise along the ring to zoom in or scroll down. Move your finger counter-clockwise to zoom out or scroll up.

**Note:** Some applications may interpret zoom events as scroll events, or may completely ignore zooming. Likewise, scroll events may be interpreted as zoom events, or ignored completely.

**KEYSTROKE... CYCLE LAYERS**

Sets the ring to cycle up or down through a stack of layers.

**KEYSTROKE... BRUSH SIZE**

Sets the ring to increase or decrease the brush size of your drawing tool.

**KEYSTROKE... CANVAS ROTATION**

Enables you to rotate or flip an entire image in Adobe Photoshop CS4 or later.

To customize the ring for other actions, select the KEYSTROKE... option. You can then define a custom [keystroke](#) function. To learn which keystroke shortcuts are supported by a particular application, see the documentation that came with the application.

Choose SKIP to set the Touch Ring toggle button to skip a function state in the toggle sequence.

See [using the Touch Ring](#) for more information.

**Important:** Some applications can override and control the Touch Ring functions. For details, see [using applications integrated for tablet control](#).

## TABLET TO SCREEN MAPPING

Select the **MAPPING** tab to change the relationship between tool movement on your tablet surface and cursor movement on the monitor screen.

MODE options control how the screen cursor moves. Select **PEN MODE** to set the screen cursor movement to correspond with the position of your Intuos4 tool on the tablet – wherever you place your tool on the tablet, the cursor will jump to a corresponding point on the screen.

The screenshot shows the 'Mapping' settings window. On the left, a monitor and tablet are shown with red lines indicating the mapping relationship. The settings on the right include:

- Orientation:** A dropdown menu currently set to 'ExpressKeys Left'. A callout explains: 'Select the **ORIENTATION** of your tablet. This setting is tablet specific, and applies to all tools and applications. Other **MAPPING** tab settings can be customized for a specific tool and application.'
- Mode:** Radio buttons for 'Pen' (selected) and 'Mouse'.
- Screen Area:** A dropdown menu set to 'Full'. A callout explains: '**SCREEN AREA**. Select a monitor screen area for tablet to screen mapping.'
- Force Proportions:** An unchecked checkbox. A callout explains: '**FORCE PROPORTIONS**. When checked, forces a proportional tablet to screen mapping relationship.'
- Tablet Area:** A dropdown menu set to 'Full'. A callout explains: 'Select a **TABLET AREA** for tablet to screen mapping.'
- Default:** A button at the bottom right.

The tablet-to-screen image dynamically updates to illustrate the selected mapping relationship.



When MOUSE MODE is selected, you can decide how you would like the mouse to track. (MOUSE TRACKING options apply only to the Intuos4 Mouse.)

- When USE TABLET ORIENTATION is selected, moving the mouse toward the top of the tablet moves the screen cursor up. In this mode the entire active area of the tablet is available for mouse tracking.
- When USE MOUSE ORIENTATION is selected, moving the mouse forward moves the screen cursor up. In this mode a reduced inset portion of the active area is available for mouse tracking. This is the default setting for all Intuos4 tablets (except Intuos4 S).

**Note:** For Intuos4 S tablets, the USE MOUSE ORIENTATION option is not recommended due to the smaller active area.

The screenshot shows the 'Mapping' control panel with the following settings:

- Mouse Tracking:**  Use Tablet Orientation,  Use Mouse Orientation
- Orientation:** ExpressKeys Left
- Mode:**  Pen,  Mouse
- Mouse Acceleration:** Slider set between Off and High.
- Mouse Speed:** Slider set between Slow and Fast.
- Default:** Button at the bottom right.

Annotations with arrows point to specific elements:

- An arrow from the top left points to the 'Mapping' title bar.
- An arrow from the top right points to the 'Mouse' radio button in the Mode section.
- An arrow from the middle left points to the 'Mouse Acceleration' slider.
- An arrow from the bottom right points to the 'Mouse Speed' slider.

Select [MOUSE MODE](#) to move the screen cursor with a “pick up and slide” motion similar to using a traditional mouse.

Sets the screen cursor acceleration.

Select a slower or faster screen cursor tracking speed.

**Notes:**

- You can switch between PEN MODE and MOUSE MODE by using the screen [Radial Menu](#).
- If you frequently switch between PEN MODE and MOUSE MODE, you also can assign the MODE TOGGLE... function to one of your tool buttons.

## ORIENTATION

From the MAPPING tab, you can choose a different tablet ORIENTATION and then physically rotate your tablet to match the selection you have made. This feature allows you to set up the tablet controls for left- or right-handed use, or to configure your tablet to work with a tall monitor. See [configuring the tablet orientation](#).

EXPRESSKEYS LEFT	Tablet orientation is horizontal, with Touch Ring and ExpressKeys located to the left. This is the orientation for right-handed users.
EXPRESSKEYS TOP	Tablet is rotated 90 degrees clockwise, with Touch Ring and ExpressKeys oriented toward the top.
EXPRESSKEYS RIGHT	Tablet orientation is horizontal, with Touch Ring and ExpressKeys located to the right. When this option is selected, the tablet operation and the Wacom Tablet control panel options are automatically configured for correct left-handed use. <b>Note:</b> If you have an Intuos4 Mouse or Lens Cursor, click the control panel OPTIONS button to set the device for right- or left-handed use. See <a href="#">advanced options</a> .
EXPRESSKEYS BOTTOM	Tablet is rotated 90 degrees counter-clockwise, with Touch Ring and ExpressKeys oriented toward the bottom.

After making changes, verify you have correctly set the orientation by moving your pen “up” on the tablet – the screen cursor should move up as well. The selected orientation is a global tablet setting and applies to all applications.

## SCREEN AREA

Use the MAPPING tab SCREEN AREA options to define the portion of the display screen your tablet will map to.

FULL	Maps the entire monitor(s) area. This is the default setting. See also <a href="#">mapping to multiple monitors</a> .
MONITOR	Maps the entire area of a single monitor that you choose. If more than one monitor is connected to your system, an option will be available for each detected monitor.
PORTION...	Selecting PORTION... brings up the PORTION OF SCREEN dialog box.

Choose a method for defining a portion of the display:

- Drag corners of the foreground graphic to select the screen area.
- Select the CLICK TO DEFINE SCREEN AREA button and move the screen cursor to select the screen area. Be sure to follow any MESSAGE prompts.
- Enter coordinate values.

After defining a portion of the screen, you may need to use a different input device to access other portions of the screen area.

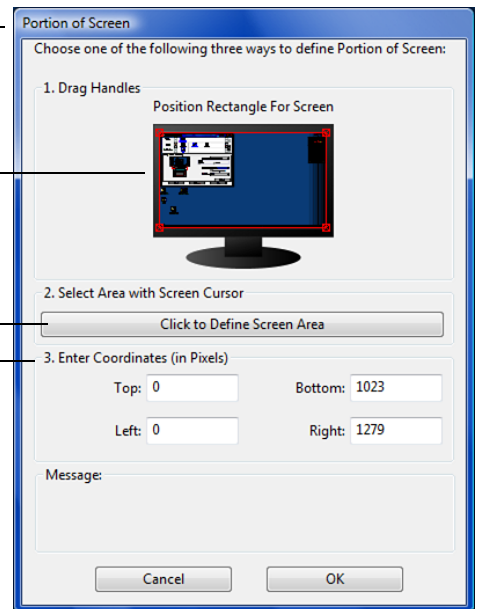

## FORCE PROPORTIONS

In the MAPPING tab, check or uncheck the FORCE PROPORTIONS box to determine the tablet to screen mapping relationship.

When FORCE PROPORTIONS is unchecked, the correct scale or proportions are not maintained. The selected tablet area is mapped to the selected display area. Drawing a circle on the tablet may create an ellipse on the display screen.

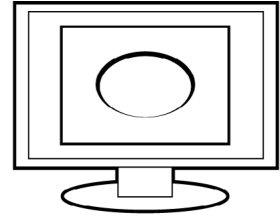

When FORCE PROPORTIONS is checked, the correct vertical and horizontal proportions are maintained. Drawing a circle on the tablet results in a circle on the display screen. Depending on your settings, some portions of the tablet active area may no longer be usable when this option is selected.

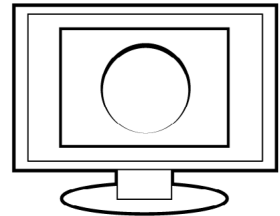

**Note:** Although Intuos4 is optimized for use with 16 : 10 aspect ratio displays, the default settings automatically adjust for use with other aspect ratio displays.

## TABLET AREA

In the MAPPING tab, use the TABLET AREA options to define the tablet area that will be mapped to the screen area:

FULL The entire active area of the tablet is mapped. This is the default setting.

PORZION... Selecting PORZION... brings up the PORTION OF TABLET dialog box.

Choose a method for defining a portion of the tablet:

- Drag corners of the foreground graphic to select the tablet area that will be mapped to your selected screen area.
- Select the CLICK TO DEFINE TABLET AREA button and use your tool on the tablet to select the tablet area. Be sure to follow any MESSAGE prompts.
- Enter coordinate values.

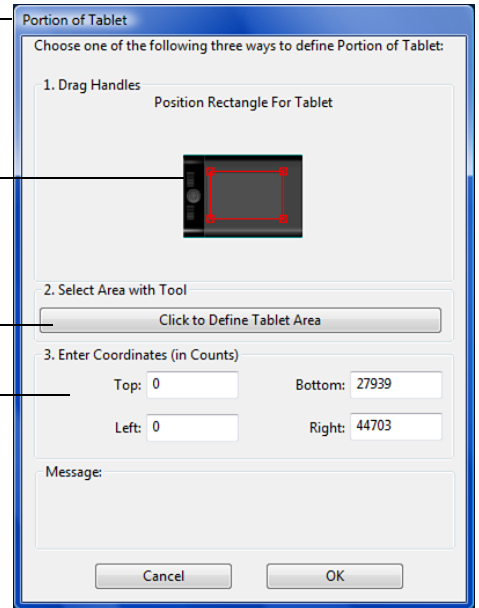

QUICKPOINT LEFT and QUICKPOINT RIGHT

Available with Intuos4 L and XL tablet models, these options divide the tablet into two independent areas: a large area for drawing, and a small area for quick navigation. Both areas are mapped to the entire display by default, and can be mapped to the screen area defined in the PORTION OF SCREEN dialog box.

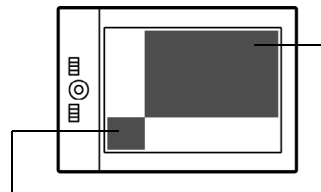

QUICKPOINT LEFT sets the QuickPoint area to the lower left corner of the tablet.

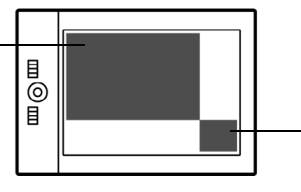

QUICKPOINT RIGHT sets the QuickPoint area to the lower right corner of the tablet.

**Note:** The QuickPoint area and drawing area are indicated by crop marks on the tablet work surface.



## MAPPING TO MULTIPLE MONITORS

If your computer is equipped with more than one monitor, Intuos4 will map to the monitors based upon how they are configured in the DISPLAY PROPERTIES control panel.

- If more than one monitor is in use and you are in extended monitor mode, the tablet maps to all monitors as if they were one large display. The below image illustrates how two monitors display the system desktop in extended mode.

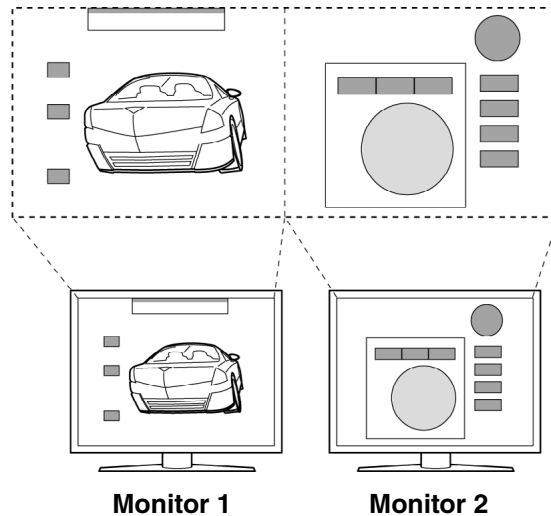

- If you are in mirror mode, the tablet maps to the entire space on each monitor and the screen cursor is displayed on each monitor simultaneously.

See your hardware and operating system documentation for details on configuring your computer and operating system for use with multiple monitors.

After you have correctly configured your computer for use with multiple monitors, you can then adjust the tablet mapping by opening the Wacom Tablet control panel and changing the appropriate options.

**Hint:** When your system is configured with multiple monitors, you can assign the DISPLAY TOGGLE function to an ExpressKey. This enables you to toggle the current tablet mapping and screen cursor between the system desktop or primary display and your other displays. See [working with Display Toggle](#).

## BUTTON FUNCTIONS

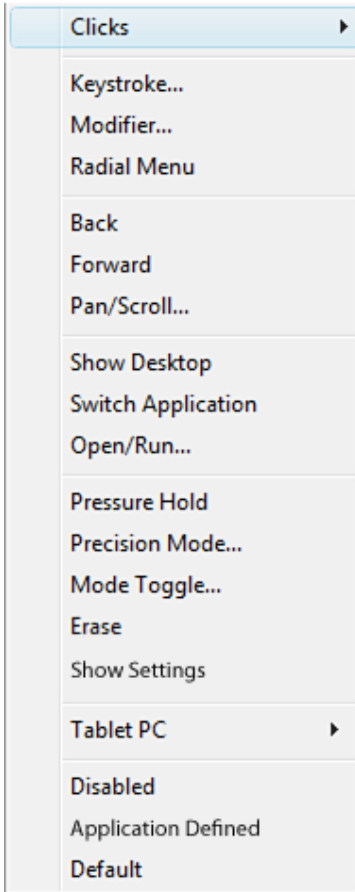

The following options are available for tool and tablet settings. Not all options are available for all controls.

Function name	Description
<b>CLICKS</b>	
• <b>CLICK</b>	Simulates a primary mouse button click. Be sure at least one button performs this function so you can always navigate and click.
• <b>RIGHT CLICK</b>	Simulates a right mouse button click, which displays a context menu.
• <b>MIDDLE CLICK</b>	Simulates a middle mouse button click.
• <b>DOUBLE CLICK</b>	Simulates a double-click. For easier double-clicking, use this function instead of tapping twice with the tip of your pen.
• <b>CLICK LOCK</b>	Simulates holding down the primary mouse button. Press the tool button once to initiate click lock. Press the button again to release click lock. Click lock is useful for dragging objects or selecting blocks of text.
• <b>4TH CLICK</b>	Simulates a 4th mouse button click.
• <b>5TH CLICK</b>	Simulates a 5th mouse button click.



**Function name**                      **Description**

**KEYSTROKE...**

Enables you to simulate keystrokes. Select this option to display the DEFINE KEYSTROKE dialog box.

Enter a keystroke or keystroke combination in the KEYS entry box. Keystroke combinations can include letters, numbers, function keys (such as F3) and modifier keys (such as SHIFT, ALT, or CTRL for Windows, or SHIFT, OPTION, COMMAND, and CONTROL for Macintosh).

You can also select special keystrokes or keystroke combinations from the ADD SPECIAL drop-down menu.

After defining a keystroke sequence, click OK.

**Important:** Because the ENTER (Windows) and RETURN (Macintosh) keys can be selected as a defined keystroke, they cannot be used to select OK. You must use your Intuos4 tool to click on the OK button.

If prompted, enter a name for the keystroke definition. The name will be displayed with the respective control or in the Radial Menu, as applicable.

You can create different keystroke functions for different applications. See [application-specific settings](#).

Deletes only the last entry in the keystroke entry box.

Clears the keystroke entry box.

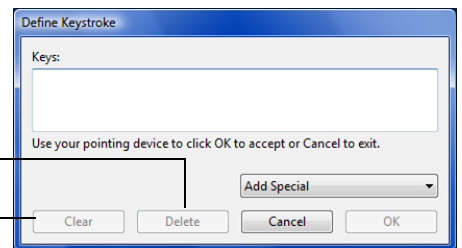

When defining keystrokes for the Touch Ring or mouse fingerwheel, the dialog box provides two KEYS entry boxes.

Assign keystroke functions as described above for clockwise and counter-clockwise movement on the ring, or front and back movement of the mouse fingerwheel.

Enter a NAME for the defined keystrokes pair and click OK.

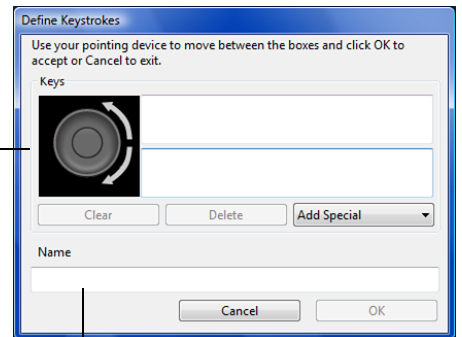

To learn which keystroke shortcuts are supported by a particular application, see the documentation that came with the application.

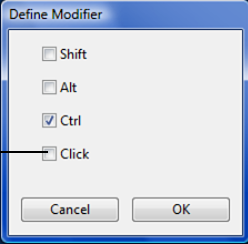
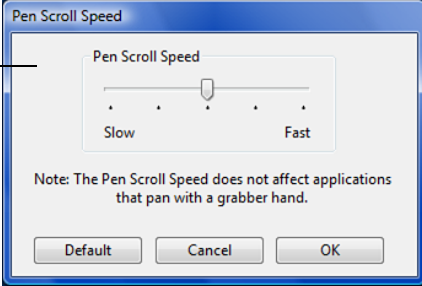
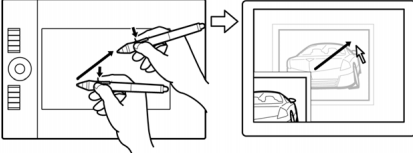

Function name	Description
<b>MODIFIER...</b>	<p>Enables you to simulate modifier key(s) (such as SHIFT, ALT, or CTRL for Windows, or SHIFT, OPTION, COMMAND, and CONTROL for Macintosh). Many applications use modifier keys to constrain the size or placement of objects.</p> <p>Choose one or more modifier key options. Select the CLICK box if you want a mouse click to occur whenever you press the tool button.</p> 
<b>RADIAL MENU</b>	<p>Displays a <a href="#">Radial Menu</a> on your screen. Each level of the hierarchical menu consists of eight menu slices which may contain various features and options to choose from.</p>
<b>BACK</b>	<p>Simulates the BACK command in browser applications.</p>
<b>FORWARD</b>	<p>Simulates the FORWARD command in browser applications.</p>
<b>PAN/SCROLL</b>	<p>Enables you to position a document or image in any direction within the active pane by pressing a tablet or pen button set for PAN/SCROLL and then dragging with the pen tip across the tablet's active area.</p> <p>When you select PAN/SCROLL, the PEN SCROLLING SPEED dialog box prompts you to set a scrolling speed for use in applications that do not support grabber hand (pixel-level) panning within a document or image.</p>  <p>A slower setting reduces the scroll rate and is useful for close-up and detail work where you need precise control of the image.</p> <p>As you move the pen tip, the document or image is repositioned to follow the direction of pen movement on the tablet.</p> <p>Release the button or lift the pen tip from the tablet surface when you are done.</p> 

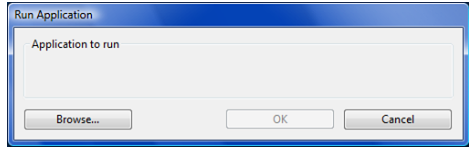

Function name	Description
<b>AUTO SCROLL/ZOOM</b>	Sets the Touch Ring to zoom in most graphics applications and scroll in most other applications.
<b>SCROLL</b>	Sets the Touch Ring for scrolling only action.
<b>ZOOM</b>	Sets the Touch Ring for zooming only action.
<b>SHOW DESKTOP</b>	Minimizes all open windows to display a clean desktop.
<b>SWITCH APPLICATION</b>	Brings up the application switching dialog with focus on the next open application. On Windows Vista systems running Aero, Flip 3D will be activated with focus on the next open applications.
<b>OPEN/RUN...</b>	<p>Opens a dialog box where you can select a specific application, file, or script to launch.</p> <p>Click <b>BROWSE...</b> to locate an application, file, or script to launch. The selection you make appears in the <b>APPLICATION TO RUN</b> box. Click <b>OK</b> to accept the selection.</p>  <p>The dialog box will close and the <b>OPEN/RUN...</b> option you have selected will be assigned as your tool button option. Simply press the tool button to launch the assigned option.</p> <p>If your selection is for the Radial Menu, it will be displayed in the Radial Menu.</p>
<b>INK TOGGLE</b>	(Macintosh.) Toggles the “ink in any application” function of Ink on and off. Ink automatically recognizes and converts your handwriting into text and inserts it into a document. Handwriting recognition must be turned on for this function to work. See your Macintosh help for information on working with Ink.
<b>EXPOSÉ</b>	(Macintosh.) Tiles all open windows. To access this option, first choose <b>KEYSTROKE...</b> and then click on the <b>ADD SPECIAL</b> menu within the dialog box.
<b>PRESSURE HOLD</b>	Locks the pressure at the current pressure level until the button is released. For example, you can paint with pressure sensitivity until you reach the brush size that you like. You can then press the button and continue painting with the same size brush until the button is released.
<b>PRECISION MODE</b>	<p>Changes the mapping around the current pen tip position such that you must move the pen twice as far for the screen cursor to cover the same distance on the display screen. To activate, press and hold the tool button to which this function is assigned. Releasing the button returns to normal mapping.</p> <p>When your tool is in <b>MOUSE MODE</b>, screen cursor movement is adjusted to act as if acceleration were off and speed set to slow.</p>
<b>DISPLAY TOGGLE</b>	For multiple monitor systems. Enables you to toggle the current tablet mapping and screen cursor between different displays when you press an ExpressKey that has been assigned this function. See <a href="#">working with Display Toggle</a> .

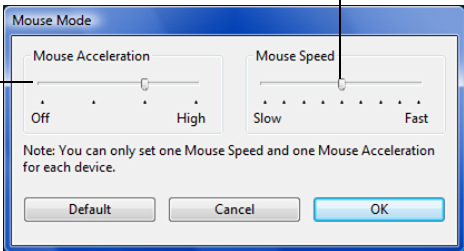

Function name	Description
<b>MODE TOGGLE...</b>	<p>Toggles between <a href="#">PEN MODE</a> and <a href="#">MOUSE MODE</a>. When first setting a tool button to MODE TOGGLE..., the MOUSE MODE dialog box is displayed where you can adjust the mouse acceleration and speed.</p> <p>Sets the screen cursor tracking speed when in MOUSE MODE.</p> <p>Sets the screen cursor acceleration when in MOUSE MODE.</p> 
<b>ERASE</b>	Default setting for the eraser. See <a href="#">erasing</a> for information on using the eraser.
<b>SHOW SETTINGS</b>	Displays (on your display screen) a diagram of the tablet ExpressKeys and Touch Ring, showing the current function settings for each control.
<b>TABLET PC</b>	
<ul style="list-style-type: none"> <li><b>TABLET PC INPUT PANEL</b></li> <li><b>JOURNAL</b></li> <li><b>TABLET PC DEFINED</b></li> </ul>	<p>(Tablet PCs and Windows Vista systems that support the Tablet PC Input Panel.) Opens the Tablet PC Input Panel when you press a tool button set to this function.</p> <p>(Windows Vista and Tablet PC systems that include Microsoft Journal.) Opens Microsoft Journal.</p> <p>(Tablet PCs and Windows Vista systems that support the Tablet PC Input Panel.) Sets the button function according to settings found in the:</p> <ul style="list-style-type: none"> <li><b>Windows Vista</b> TABLET PC SETTINGS and PEN AND INPUT DEVICES control panels.</li> <li><b>Windows XP Tablet Edition</b> TABLET AND PEN SETTINGS control panel.</li> </ul>
<b>DISABLED</b>	Disables the control function.
<b>APPLICATION DEFINED</b>	<p>Reports only the button number to the application. This is for applications, such as CAD programs, that have built-in support for the Intuos4 Mouse or Lens Cursor.</p> <p>This function may also be used by some highly integrated applications for direct control of the pen tablet ExpressKeys and Touch Ring.</p>
<b>SKIP</b>	Sets the Touch Ring toggle button to skip a function state that has been assigned this option in the toggle sequence.
<b>DEFAULT</b>	Returns a control to its default setting.

## USING AND CUSTOMIZING THE RADIAL MENU

The Radial Menu is a circular pop-up menu that provides quick access to editing, navigation, and media control functions, and more.

- To display the Radial Menu, set a tool button or ExpressKey to the RADIAL MENU function. Whenever you press that button, the Radial Menu is displayed centered at the screen cursor position.
- The hierarchical Radial Menu appears in circular format, extending over the entire desktop. Each level of the menu consists of eight control slices which may contain various features and options to choose from.
- Select an option by clicking on it within the Radial Menu. Some selections may display a submenu where you can then choose from the available options.  
Holding down the button that opens the Radial Menu allows you to click on a menu item without closing the Radial Menu.
- The menu closes after you make a selection. To close the Radial Menu without making a selection, click on the 'X' located at the center of the menu or on a control slice that has no function assigned to it. You can also again press the button used to display the menu.

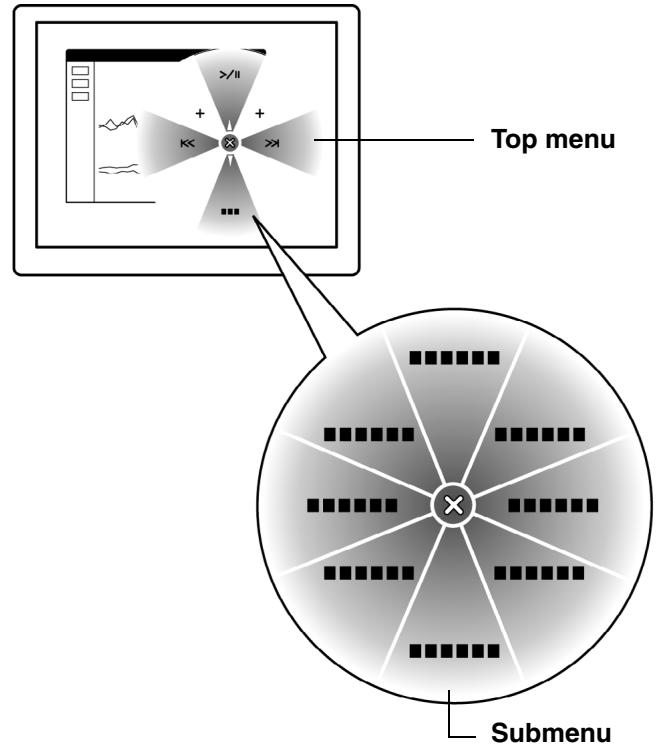

Use the RADIAL MENU tab to customize the available functions on the Radial Menu:

1. Select a menu or submenu to customize.
2. Select a control slice for which to customize settings.
3. Choose the FUNCTION(s) to perform.

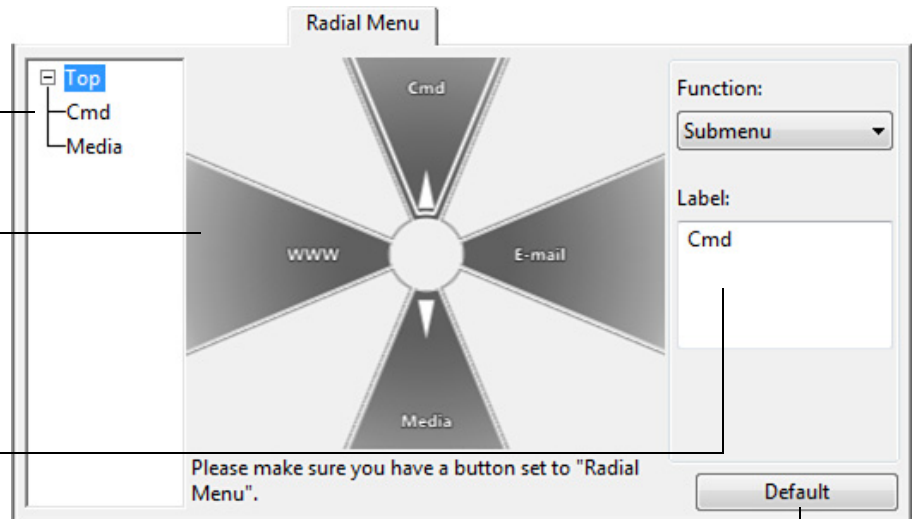

**Note:** Press the ENTER (RETURN) key to add multiple lines of text.

Returns the currently displayed Radial Menu layout to its default values.

## WORKING WITH DISPLAY TOGGLE

DISPLAY TOGGLE is available only on multiple monitor systems. This feature allows you to work with your tablet on all displays or on one display at a time. (See [mapping to multiple monitors](#).)

After setting an ExpressKey to DISPLAY TOGGLE, you can then press that button to sequentially toggle the current tablet mapping between a base mapping (the current setting from the MAPPING tab) and other monitors. As an example:

1. The entire display area of a multi-monitor system is set up for extended mode and assigned to the active area of the Intuos4 tablet.

2. Pressing a tool button to which the DISPLAY TOGGLE function has been assigned toggles the tablet mapping to the next display in sequence

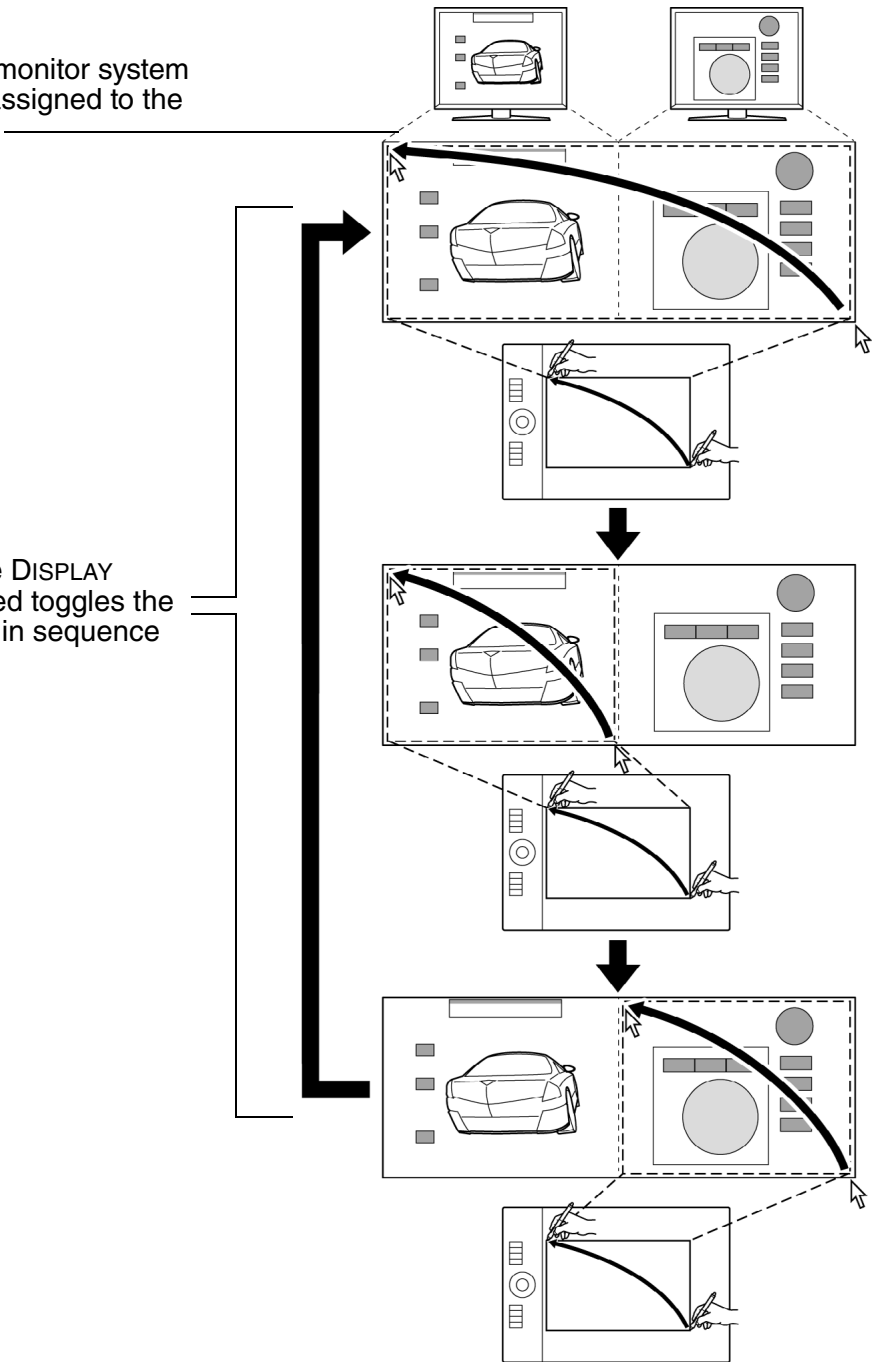



In the Wacom Tablet control panel, the DISPLAY TOGGLE tab is automatically available when the Intuos4 tablet is installed on a multi-monitor system. This tab lets you set which monitor(s) will be included in the toggle sequence.

On the DISPLAY TOGGLE tab all monitors are selected in the toggle sequence by default. Uncheck any monitor you want removed from the toggle sequence.

- The base mapping is the tablet and display mapping that is defined in the MAPPING tab. By default, this would include all monitors unless you have defined a specific monitor as your primary monitor in the MAPPING tab.
- As you toggle to the next monitor, each tool's active tablet area is mapped to that monitor (in PEN MODE).
- Toggling one more time after the last checked monitor returns the system to the base mapping.

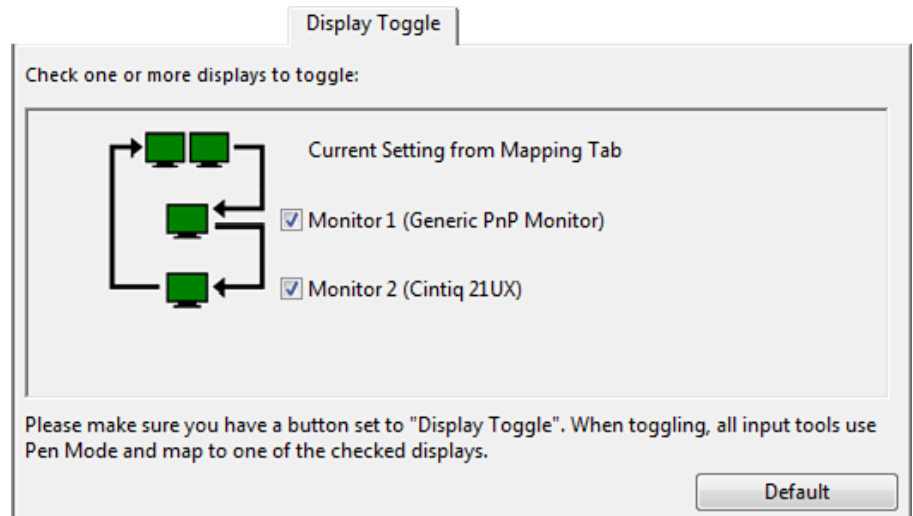

**Important:** When using application-specific settings with DISPLAY TOGGLE, make sure that each customized application in the APPLICATION list (including ALL OTHER) has a tool button assigned to DISPLAY TOGGLE. The easiest way to do this is to assign DISPLAY TOGGLE to an ExpressKey prior to creating any application-specific settings.

Note that any of the following actions will return the toggle sequence to the base mapping:

- Launching a graphics application that supports pressure sensitivity.
- Logging out of or rebooting the system.
- Switching users (Fast User Switching).
- Placing the system in sleep mode.
- Changing the MAPPING or DISPLAY TOGGLE tab settings.
- Changing the resolution or number of displays on your system.
- Using the MODE TOGGLE... function.
- Selecting PEN MODE or MOUSE MODE from the [Radial Menu](#).

**Tip:** To toggle between monitors without including the 'full display' option, disable the first display on the DISPLAY TOGGLE tab. Then go to the MAPPING tab and set the current SCREEN AREA to the first display.

## WORKING WITH MULTIPLE TOOLS

The Wacom Tablet control panel is designed to help you customize and keep track of your Intuos4 tool settings. The tool you use to open the control panel is automatically selected, and the appropriate tabs for that tool are displayed.

Each Intuos4 tool has a Tool ID that makes it unique. Any custom settings apply only to the specific tool for which they were made. Identical Intuos4 tools appear as numbered devices. The selected tool is highlighted.

The TOOL list displays an icon for the tablet FUNCTIONS and for each Intuos4 tool that has been used on the tablet.

If application-specific settings have not been added, the ALL icon is displayed and the tool settings apply to all applications.

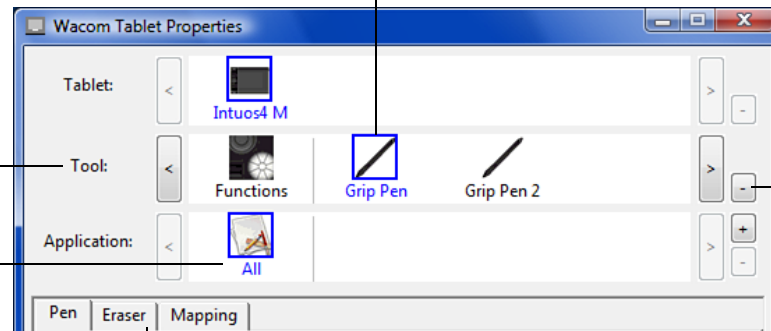

Tab settings apply only to the selected tool and application.

Removes the selected tool.

The button is inactive when there is only one item in the list.

The FUNCTIONS icon cannot be deleted.

**Tip:** You can rename any tool by double-clicking on the tool's icon and entering a new name. You cannot rename the FUNCTIONS icon.

**To add a tool to the control panel's TOOL list,** simply use the tool on your Intuos4 tablet.

- When a new tool is first placed on the tablet it will function with the appropriate default settings for that tool, and not the custom settings of other tools – even if they are identical devices. If the Wacom Tablet control panel is open, the tool is automatically added to the TOOL list and you can customize the tool by changing the tab settings.
- When you select a tool that you have added to the TOOL list, the appropriate tab settings for that tool are displayed. Any changes you make to the tab settings will then apply to that tool. Your changes take effect immediately.

**To remove a selected tool from the TOOL list,** click on the TOOL list's [ – ] button. In the dialog box that appears, click DELETE to confirm your selection. The selected tool is removed from the list, along with any custom settings you may have created for it. (A removed tool can be added back to the TOOL list by placing it back onto the tablet.)

## APPLICATION-SPECIFIC SETTINGS

You can customize your Intuos4 tools for use with a particular application. For example, you may prefer a firm pen tip pressure setting in one application and a soft pressure setting in another. The APPLICATION list enables you to add an individual application to the list and then customize your tool settings for that application.

- **When no application-specific settings have been created** and a tool is selected from the TOOL list, the APPLICATION list displays the ALL icon which contains tool settings that apply to all of your applications. In the example below, no application-specific settings have been added for the MOUSE – the ALL icon is displayed and the MOUSE will have the same settings in all applications.



- **When application-specific settings are added** to the APPLICATION list, the ALL icon changes to ALL OTHER, and an application icon is displayed for the newly added application(s).

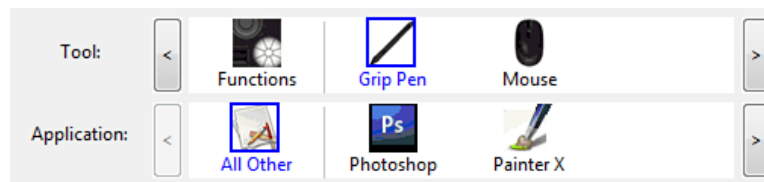

In the above example, application-specific settings have been added for the GRIP PEN. If you select the ALL OTHER icon and make changes to the tab settings, your changes will apply to the GRIP PEN in all applications except those which you have added to the APPLICATION list. If you select an application icon and make changes to the tab settings, your changes will apply to the GRIP PEN only while you are using that application.

When you create application-specific settings, you are creating a separate group of settings for the selected tool and application. See the following sections for more details:

[Creating an application-specific setting](#)

[Changing application-specific settings](#)

[Removing application-specific settings](#)

**Hint:** To review the ExpressKeys or Touch Ring function settings for the current front-most application, set an ExpressKey to SHOW SETTINGS and press the key at any time.

## CREATING AN APPLICATION-SPECIFIC SETTING

First choose the tablet and tool for which you want to create an application-specific setting. Then click on the APPLICATION list's [ + ] button to display the ADD APPLICATION FOR CUSTOM SETTINGS dialog box.

Choose from one of two methods to select an application:

- Open the application for which you want to create custom settings, and then select that application from the CURRENTLY OPEN APPLICATIONS box.
- BROWSE to select the executable file of any application installed on your computer.

Your selection is added to the SELECTED APPLICATION box where the name of the selected application is displayed.

Click OK to complete the process.

**Note:** If two programs have the same executable file name, they will share the same customized settings.

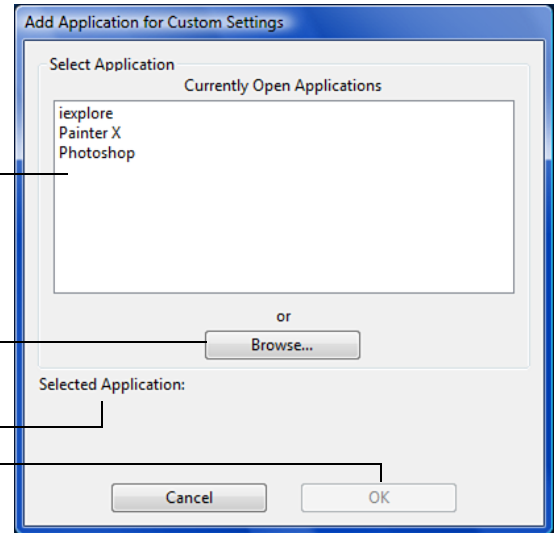

After adding an application, its icon appears in the APPLICATION list whenever the respective tool is selected in the TOOL list. Select the application and then customize the control panel tab settings for your tool and the selected application.

Once you have created application-specific settings, applications that have not been customized in this manner will use the tool settings for ALL OTHER.

**Tip:** First customize settings for one application. When you feel comfortable with the process, you can create more application-specific settings.



## CHANGING APPLICATION-SPECIFIC SETTINGS

To change tool settings for a specific application, select the tool and the application and then customize the control panel tab settings.

## REMOVING APPLICATION-SPECIFIC SETTINGS

To remove an application-specific setting:

1. In the TOOL list, select the tool from which you want to remove the application-specific setting. Then, in the APPLICATION list select the application you want to remove.
2. Click on the APPLICATION list's [ – ] button. In the dialog box that appears, click DELETE to confirm your selection. The selected application is removed from the list, along with any custom tool settings that you may have created for it.

**Hint:** To quickly remove all application-specific settings from a single tool, remove the tool from the TOOL list. Then place the tool back on the tablet. The tool will be added back to the TOOL list using the default settings.



## TROUBLESHOOTING

Most of the time your tablet will work flawlessly. But if you are having trouble, Wacom recommends you do the following:

1. If the Wacom tablet driver failed to load properly, first perform the recommended action in any error message that may appear on your screen. If that does not solve the problem, review the troubleshooting procedures in this chapter.
2. Look in the [troubleshooting tables](#). Your problem may be described there and you can try the solution offered.
3. Open the Wacom tablet Read Me file for any information updates.
4. Test your tablet and input tools. See [testing your tablet](#) and [testing your tools](#).
5. If you are having a compatibility conflict between Intuos4 and a new hardware or software product, see [obtaining driver downloads](#) for information on downloading an updated software driver. Wacom periodically updates the software driver to maintain compatibility with new products.
6. Check the FAQs (Frequently Asked Questions) on the Wacom web site for your region.
7. If you have tried the suggestions in this manual and still cannot resolve the problem, then contact Wacom for Technical Support. See [technical support options](#) and the Read Me file for information on where to obtain support for your region.

[Testing your tablet](#)

[Testing your tools](#)

[Troubleshooting tables](#)

[Technical support options](#)

[Obtaining driver downloads](#)

## TESTING YOUR TABLET

1. Turn on your computer and wait until the system has fully loaded.
2. **Check the tablet connection.** A tablet status LED will light whenever the tablet is properly connected and your computer has registered it as a USB device. If an LED is on, continue with step 3.

If an LED does not glow when the computer is on and the system has fully loaded, then:

- Make sure the tablet USB cable is securely connected to the tablet and to an active USB port on your computer. Intuos4 requires that you connect to a primary USB port (located directly on your computer) or to a powered USB hub.
- If you are connecting the tablet to a powered USB hub, be sure the USB hub is properly connected to your computer and is active.
- Connect the tablet to a different powered USB port or try connecting to the powered USB port on another computer.
- If a tablet LED does not illuminate after your computer is on and has finished booting up, your USB port may be disabled. Verify that you have connected the tablet to an active USB port.

**Note:** For best results when troubleshooting no power to the tablet (a status LED does not light), plug the tablet directly into the system USB port located on your computer. Temporarily eliminate any external hubs in use until you determine that the system recognizes the tablet and that it is functional. When the tablet is working properly, it is usually okay to then move the tablet to a powered USB hub.

3. **Check the Grip Pen.**
  - Move your pen across the tablet active area; the screen cursor should move in the corresponding direction on your monitor or display screen.
  - Press the pen tip against the surface of the tablet. A status LED should brighten.
  - Next, without applying pressure to the pen tip, hold the pen tip within approximately 10 mm (0.39 inch) of the tablet surface and press the side switch. The LED should again brighten.
  - Turn the pen over and press the eraser against the surface of the tablet; the LED should brighten.
  - See [testing your tools](#) for detailed information.
4. **Check the Touch Ring.** See [testing your tools](#).
5. **Check the ExpressKeys.** See [testing your tools](#).
6. **Check the Intuos4 Mouse and any other tool(s).** See [testing your tools](#).
7. If these tests fail, you may have a defective input tool or tablet. See [technical support options](#).
8. After testing, use the Wacom Tablet control panel to reconfigure your tablet and tools for any custom settings you may originally have been using.

## TESTING YOUR TOOLS

If an input tool does not work as you expect, first open the Wacom Tablet control panel and check the assigned functions or reset the tool to its default condition.

- To quickly return a tool to the default settings, remove it from the TOOL list by clicking on the control panel list's [ - ] button.
- After the tool has been removed, place it back onto the tablet. The tool will be added back to the TOOL list with its default settings.

To test your input tools:

- In the Wacom Tablet control panel, click on the ABOUT button. In the dialog box that appears, click on the DIAGNOSE... button. The DIAGNOSTICS dialog box displays to show dynamic information about the tablet hardware and pointing devices.
- If you have more than one tablet connected to your system, in the TABLET INFO column select the tablet for which you are testing your tool.
- Use the information presented in the DIAGNOSTICS dialog box when testing your tablet and tools.

**Note:** When testing your tool buttons, if a button is set to RADIAL MENU or OPEN/RUN..., that function will occur when the button is pressed. In this case you may want to change that button function before testing.

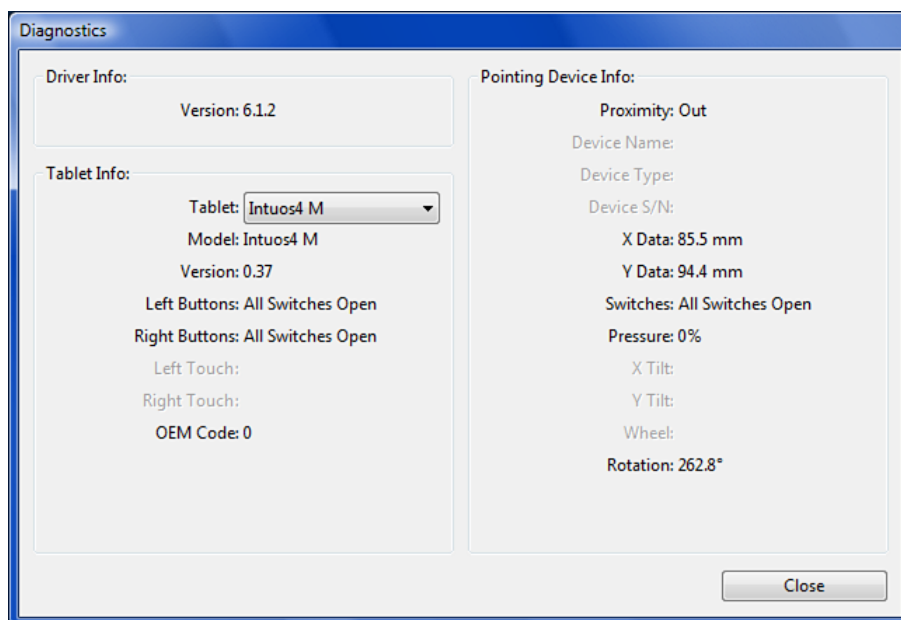

[Testing a pen](#)

[Testing the Touch Ring](#)

[Testing the ExpressKeys](#)

[Testing the mouse](#)



## TESTING A PEN

1. While observing the POINTING DEVICE INFO column, bring your Intuos4 tool within 10 mm (0.39 inch) of the tablet active area. A value for [PROXIMITY](#), the DEVICE NAME, DEVICE TYPE, and a DEVICE S/N (serial number) should be displayed. If you have more than one tablet connected to your system, be sure you have selected the TABLET for which you are testing your tools from the TABLET INFO column.
2. Move your tool along the tablet surface. The X and Y DATA values should change to reflect the tool position.
3. Test your Intuos4 pen switches. A tablet status LED should brighten each time you click with the tool tip, press the side switch, or press the tool's eraser to the tablet.
  - Click on the tablet surface with the tool tip – the SWITCHES state and PRESSURE value should change. (PRESSURE should change from approximately 0% with no pressure applied to approximately 100% when full pressure is applied.)
  - Press the side switch without pressing the tip to the tablet – the SWITCHES state should change. (For the Intuos4 pen, do this for both positions of the DuoSwitch.)

<b>Pen</b>	Tip = 1
	DuoSwitch (lower position) = 2
	DuoSwitch (upper position) = 3
	Eraser = 1

---

<b>Airbrush</b>	Tip = 1
	Side Switch = 2
	Eraser = 1

- Press the tool's eraser to the tablet – the SWITCHES state and PRESSURE value should change. (Pressure should change from approximately 0% with no pressure applied to approximately 100% when full pressure is applied.)
  - For the Airbrush, move the fingerwheel forward – the WHEEL value should decrease to a value of approximately 0 when the fingerwheel is all the way forward. Move the fingerwheel backward – the WHEEL value should increase to approximately 1000 when the fingerwheel is all the way back.
4. Test tilt for the x-axis by moving the pen from a vertical position toward the right; the X TILT value should change from approximately 0 to +60. Now move the tool to the left of vertical; the X TILT value should change from approximately 0 to -60.
  5. Test tilt for the y-axis by moving the pen from a vertical position toward the bottom of the tablet; the Y TILT value should change from approximately 0 to +60. Now move the tool toward the top of the tablet; the Y TILT value should change from approximately 0 to -60.
  6. If you are testing an Art Pen, test pen rotation by holding the pen vertically and twisting it around its axis. The displayed ROTATION value should change.
  7. When you are done, click on the CLOSE button to exit the dialog box.

## TESTING THE TOUCH RING

1. With the DIAGNOSTICS dialog box open, observe the TABLET INFO column as you test the tablet Touch Ring. If you have more than one tablet connected to your system, be sure you have selected the tablet you are testing from the TABLET INFO column.
2. Slide your finger around the entire circumference of the Touch Ring. As you touch and move your finger along the Touch Ring, a LEFT TOUCH or RIGHT TOUCH number will indicate your current finger position on the Touch Ring.
3. Press the Touch Ring toggle button to toggle between the four customizable states. As you cycle between settings, a corresponding LED should illuminate. Within the DIAGNOSTICS dialog box, the button state is also shown as LEFT BUTTONS.

**Note:** If any of the functions are set to SKIP, the corresponding LED will be skipped in the toggle sequence.

4. When you are done, click on the CLOSE button to exit the dialog box.

**Important:** Remember that some applications can override and control the Touch Ring functions. Consider closing any open applications except the Wacom Tablet control panel when testing the Touch Ring. For details, see [using applications integrated for tablet control](#).

## TESTING THE EXPRESSKEYS

1. With the DIAGNOSTICS dialog box open, observe the TABLET INFO column as you test each ExpressKey. If more than one tablet is connected to your system, be sure you have selected the tablet you are testing from the TABLET INFO column.
2. Test the keys on your tablet by clicking them one at a time. Each time you press a key, its number will be displayed next to the LEFT KEYS category.
3. On the tablet itself, verify also that a tablet ExpressKeys icon is visible for each corresponding ExpressKey.
4. When you are done, click on the CLOSE button to exit the dialog box.

**Important:** Remember that some applications can override and control the ExpressKey functions. Consider closing any open applications except the Wacom Tablet control panel when testing the ExpressKeys. For details, see [using applications integrated for tablet control](#).



## TESTING THE MOUSE

1. With the DIAGNOSTICS dialog box open, place the Intuos4 Mouse on the tablet's active area and test by clicking each mouse button. A tablet status LED should brighten, and the SWITCHES state should change for each button you click.

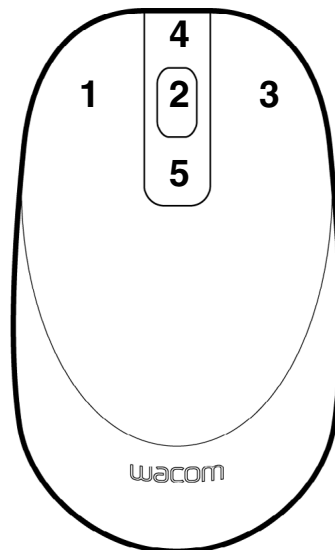

2. When the DIAGNOSTICS dialog box is first opened the WHEEL status should be 0. Move the fingerwheel backward. The WHEEL status should change from 0 to +1.
3. Move the fingerwheel forward. The WHEEL status should change to -1.
4. When you are done, click on the CLOSE button to exit the dialog box.



## TROUBLESHOOTING TABLES

If you encounter problems with your Intuos4 tools or tablet, see the following tables. Your problem may be described here, and you can try the solution offered. Be sure you refer to the Read Me file for the latest information updates.

For additional information, visit Wacom's web site at <http://www.wacom.com/productsupport>.

[General problems](#)

[Windows-specific problems](#)

[Macintosh-specific problems](#)

### GENERAL PROBLEMS

The computer does not have an available USB port.	Check if there is an available USB port on a powered USB hub. If not available you will need to add a powered USB hub or USB card.
The tablet status LEDs are off. An LED does not illuminate when using the pen, mouse, or Touch Ring toggle button.	<p>Verify that the tablet USB cable is properly connected to the tablet and to an active USB port.</p> <p>Be sure the tablet USB cable is plugged into a primary USB port (directly into your computer) or into a powered USB hub. If connecting to a powered USB hub device, make sure the hub is connected to an active USB port and that the hub is active.</p>
After plugging in the tablet, a message appears indicating that the USB device needs more power than is available.	Make sure the tablet is plugged into a primary USB port on your computer or into a powered USB hub attached to your computer.
When using the pen to operate the Touch Ring, the Touch Ring does not work well.	The Touch Ring is designed to be used with your finger, and does not work with the pen tip.
The pen works only in MOUSE MODE, and does not draw or ink with pressure sensitivity.	<p>The tablet driver software was not installed or did not load properly.</p> <ul style="list-style-type: none"> <li>• Make sure the tablet driver software is installed and functioning.</li> <li>• Insert the Intuos installation CD into your computer and install the driver software for the tablet.</li> </ul>
The pen does not draw or ink with pressure sensitivity.	Some applications require that you turn on the pressure capabilities within the application or selected tool before the pen will respond as a pressure-sensitive tool.





Clicking is difficult.	Try using a lighter TIP FEEL. See <a href="#">adjusting tip feel and double-click</a> .
Double-clicking is difficult.	<ul style="list-style-type: none"> <li>• Use the side switch to double-click. Review the technique in <a href="#">clicking</a>.</li> <li>• Be sure you are quickly tapping the tablet twice in the same place on the tablet's active area.</li> <li>• Try increasing the TIP DOUBLE CLICK DISTANCE. See <a href="#">adjusting tip feel and double-click</a>.</li> <li>• Try using a lighter TIP FEEL. See <a href="#">adjusting tip feel and double-click</a>.</li> <li>• Set an ExpressKey to DOUBLE CLICK and use it to issue double-clicks.</li> <li>• <b>Windows:</b> Try setting your system to launch programs with a single click. See <a href="#">clicking</a>.</li> </ul>
The pen selects everything, will not stop selecting.	Open the Wacom Tablet control panel and go to the PEN tab. Move the TIP FEEL slider toward FIRM, or select DETAILS... and increase the CLICK THRESHOLD setting. If this does not help, see <a href="#">testing your tools</a> .
The eraser selects everything or will not stop erasing.	Open the Wacom Tablet control panel and go to the ERASER tab. Move the ERASER FEEL slider toward FIRM, or select DETAILS... and increase the CLICK THRESHOLD setting. If this does not help, see <a href="#">testing your tools</a> .
You notice a delay at the beginning of pen or inking strokes.	Open the Wacom Tablet control panel and go to the PEN tab. Try decreasing the TIP DOUBLE CLICK DISTANCE (see <a href="#">adjusting tip feel and double-click</a> ). If that does not work, try dragging the TIP DOUBLE CLICK DISTANCE slider to the OFF position in order to turn off double-click assist.
You have to press hard with the pen when clicking, drawing, or writing.	Open the Wacom Tablet control panel and go to the PEN tab. Move the TIP FEEL slider toward SOFT, or select DETAILS... and decrease the SENSITIVITY and CLICK THRESHOLD settings.
The pen tip does not function.	<p>Be sure you are using the pen that originally came with Intuos4. Other pens may not function properly on the tablet.</p> <p>Make sure a tablet status LED brightens when the tip is pressed. If not, you may have defective hardware. See <a href="#">testing your tools</a>.</p> <p>Check the control panel's PEN tab and verify that a CLICK function is assigned to the tip.</p>
Changing the function settings of an input tool has no effect.	Make sure you change the settings for the tool and the application that you are using. See <a href="#">working with multiple tools</a> and <a href="#">application-specific settings</a> .





The pen side switch does not work.

Be sure you are using the pen that originally came with Intuos4 or an Intuos4 accessory pen. Other pens may not function properly on the tablet.

Be sure to press the side switch when the pen tip is within 10 mm (0.39 inch) of the tablet's active area – do this without pressing down on the pen tip.

In the Wacom Tablet control panel, verify that the side switch is set to the function you are expecting to occur for the application and tool you are using.

Check also the SIDE SWITCH MODE. If CLICK & TAP is selected, you will need to first press the side switch while touching the pen tip to the tablet surface in order to perform a click function. See [customizing tool buttons](#).

Make sure a tablet status LED brightens when you press the side switch. If not, you may have defective hardware. See [testing your tools](#).

The screen cursor jumps back.

Do not place an Intuos4 tool on the tablet when it is not in use, or when you are using another pointing device. Leaving your tool on the tablet may interfere with screen cursor positioning when using other input devices.

Cannot move the cursor where you want to on the screen, or the line you are drawing does not line up with the location of the pointer in paint applications.

Open the Wacom Tablet control panel and go to the MAPPING tab. Verify that PEN MODE is selected and that the SCREEN AREA is set to FULL for the selected tool and application. If this does not help, click on the DEFAULT button to reestablish tablet to screen mapping. If you are still having difficulty, remove the tablet preferences.

The computer does not go to sleep.

When you are not using your Intuos4 input tool(s), remove them from the tablet surface or the tablet will continue to send data, keeping the computer awake.

When using the tablet the screen cursor is very erratic or jumps around.

On rare occasions the tablet may receive interfering radio frequencies from a computer monitor or nearby AM radio station. If you notice interference from a monitor, try moving the tablet at least 6 inches away from the monitor, or change the monitor refresh rate or monitor resolution.

When using Intuos4 on a multiple monitor system, you cannot use the pen tip to control the other monitor(s).

Determine if an ExpressKey has been set to DISPLAY TOGGLE and if it may have been activated accidentally. See [working with Display Toggle](#).

Verify that the SCREEN AREA in the MAPPING tab is set to FULL.

You can also use your pen to control the other monitors in MOUSE MODE. To use MOUSE MODE, first set a pen button to MODE TOGGLE.... Then use the button to toggle between PEN MODE and MOUSE MODE.





When working in some applications, the ExpressKeys or Touch Ring perform a different function than what is set in the Wacom Tablet control panel.

Some applications can override and control the ExpressKey and Touch Ring functions.

- When an ExpressKey is overridden by an application, the ExpressKeys display will automatically update to show either the new function name or “Application Defined.”
- See [using applications integrated for tablet control](#).

If you use application-specific settings, make sure you have updated the settings for the correct application.

---

The tablet is set to EXPRESSKEYS RIGHT (or EXPRESSKEYS LEFT), but at the log-in screen the tablet seems to work upside down.

Reinstall the tablet driver from the Intuos installation CD and change the default orientation of the tablet. See [configuring the tablet orientation](#) for details.

## WINDOWS-SPECIFIC PROBLEMS

You suspect the tablet preferences may be corrupted, or want to make certain that all settings are at their factory defaults.

Delete the tablet preferences as follows:

First close any open applications. Then click the START icon and select ALL PROGRAMS. Select WACOM TABLET and TABLET PREFERENCE FILE UTILITY. In the dialog box that appears, click on the REMOVE My Preferences button to delete the preferences for the current user.

To delete preferences for multiple users on Windows Vista or XP systems, click on the REMOVE button under All User Preferences. Note that administrator rights are required to delete preferences for all users. Relaunch any currently open tablet-aware applications that you may be running.

If you had previously backed up your preference file, you can quickly restore the tablet preferences by clicking on the RESTORE... button under My Preferences.

---

After changing right- and left-handed settings in the computer’s mouse control panel, the pen tip no longer functions properly and the Intuos4 Mouse tool button functions are reversed.

Restart Windows for your Wacom tool settings to be correctly recognized.



## MACINTOSH-SPECIFIC PROBLEMS

At startup, a dialog box appears telling you that either the driver failed to load or the tablet preferences have not yet been created.

The tablet was not detected at startup. Make sure the USB interface cable is securely connected to the tablet and to an active USB port on your computer. Make sure also that a tablet status LED is illuminated. If your tablet is plugged into a powered USB hub, make sure the hub is connected and active.

From the GO menu, select the UTILITIES folder and launch the SYSTEM PROFILER. Select USB from the HARDWARE section of the CONTENTS list. A Wacom USB tablet model should be listed. If a tablet model is not listed, check the USB tablet cable connection or try plugging the tablet into a different USB port.

If this does not help, contact Wacom for Technical Support. See [technical support options](#).

---

You suspect the tablet preferences may be corrupted, or want to make certain that all settings are at their factory defaults.

Delete the tablet preferences. First open the main APPLICATIONS folder. Then open the WACOM TABLET folder and run the REMOVE WACOM TABLET utility.

- **Single user.** When the utility starts, select CURRENT USER and click on the REMOVE button. Log out, then log back in. When the tablet driver loads it will create a new preferences file with the factory defaults.
- **Multiple users.** When the utility starts, select ALL USERS and click on the REMOVE button. Log out, then log back in. When the tablet driver loads it will create new preferences files with the factory defaults.

If you had previously backed up your preference file, you can quickly restore the tablet preferences for the CURRENT USER or ALL USERS by clicking on the RESTORE... button within the utility.

**Note:** Do not manually remove the WACOM TABLET.PREFPANE file from the main LIBRARY PREFERENCEPANES folder. This file is only to be removed when uninstalling the tablet software driver, and then only when using the REMOVE WACOM TABLET utility.







Ink does not work correctly with Intuos4.

There may be a problem with the Ink preferences. Remove the damaged preference files as follows. They will be re-created when you enable handwriting recognition.

1. Open the SYSTEM PREFERENCES pane, choose SHOW ALL and select INK. Then turn off handwriting recognition.
2. From the GO menu, choose your HOME. Open the LIBRARY and PREFERENCES folders. Remove the following preferences:
  - COM.APPLE.INK.FRAMEWORK.PLIST
  - COM.APPLE.INK.INKPAD.PLIST
  - COM.APPLE.INK.INKPAD.SKETCH
3. Go back to SYSTEM PREFERENCES and INK, and then enable handwriting recognition.
4. Test the Ink function using your Wacom tablet and pen.
5. If this procedure does not resolve your problem with Ink, contact Apple Support for further assistance. Wacom is not the software manufacturer for Ink and we are limited in our abilities to support a third-party software application.



## TECHNICAL SUPPORT OPTIONS

If you have a problem with your Wacom tablet, first check the tablet installation guide to be sure the unit is installed correctly. Then review the [troubleshooting](#) procedures.

If you cannot find the answer in this manual, you may find updated information about your problem in the appropriate Read Me file for your platform (located on the Intuos installation CD). You can also check the product FAQs (Frequently Asked Questions) on the Wacom web site for your region.

If you have an Internet connection you can download the latest software drivers from the Wacom web site for your region. See [obtaining driver downloads](#).

If you cannot solve the problem and you think your Wacom tablet is not working properly, contact the Wacom support staff for the area where your product was purchased. See the Wacom tablet Read Me file, located on the Intuos installation CD, for contact information.

When you call, you should be at your computer with the following information available:

- This manual.
- Tablet serial and model number. (Look on the bottom of the tablet.)
- Driver version number. (See the Intuos installation CD or click on the Wacom Tablet control panel ABOUT button.)
- The make and model of your computer, and operating system version number.
- A list of peripheral devices attached to your computer.
- The software application and version you were using when the problem occurred.
- The exact wording of any error message that appeared on your screen.
- What happened and what you were doing when the problem occurred.
- How you tried to solve the problem.



## OBTAINING DRIVER DOWNLOADS

Wacom periodically updates the tablet software driver to maintain compatibility with new products. If you are having a compatibility problem between Intuos4 and a new hardware or software product, it may be helpful to download a new Wacom tablet software driver (when available) from the Internet.

### USA, Canada, Central and South America

Worldwide Web: <http://www.wacom.com/productsupport> Software updates.

### Europe, Middle East and Africa

Worldwide Web: <http://www.wacom.eu/downloads> Software updates.

### Japan

Worldwide Web: <http://tablet.wacom.co.jp/download> Software updates. (Japanese)

### Asia Pacific (English)

Worldwide Web: <http://www.wacom-asia.com> Software updates. (English)

### China

Worldwide Web: <http://www.wacom.com.cn> Software updates.  
(Simplified Chinese)

### Korea

Worldwide Web: <http://www.wacomkorea.com> Software updates. (Korean)

### Taiwan

Worldwide Web: <http://www.wacom.com.tw> Software updates.  
(Traditional Chinese)



## APPENDIX

This section contains a variety of information: tips on caring for your tablet and tools, instructions on how to uninstall the tablet software, your license and warranty, and more.

[Caring for your tablet and tools](#)

[Replacing the pen tip](#)

[Uninstalling the software](#)

[Managing your tablet preferences](#)

[Changing the tablet mode](#)

[Installing multiple tablets](#)

[Advanced options](#)

[Optimizing the ExpressKeys display](#)

[Using applications integrated for tablet control](#)

[Using the optional Airbrush and Art Pen](#)

[Intuos4 Lens Cursor](#)

[Working with AutoCAD](#)

[Pen and digital ink capabilities in Windows Vista](#)

[Product specifications](#)

[Product information](#)

[Ordering parts and accessories](#)

[Available parts and accessories](#)

[Radio and television interference](#)

[Precautions](#)

[License and Warranties \(Worldwide, Except for Europe, Africa and Middle East\)](#)

[Licence warranty conditions \(Europe, Africa and Middle East\)](#)

## CARING FOR YOUR TABLET AND TOOLS

Keep your Intuos4 tools and tablet surface clean. Dust and dirt particles can stick to your tools and cause excessive wear to the tablet surface. Regular cleaning with a soft, damp cloth will help to prolong the life of your tablet surface and tools; you can also dampen the cloth using a very mild soap diluted with water.

Do not use volatile liquids, such as paint thinner or benzene, because they may damage the plastic case.

Keep your tablet and tools in a clean, dry place and avoid extremes in temperature. Room temperature is best. Also, your tools and tablet are not made to come apart. Twisting the pen case can break the pen.

Taking apart the product will void your warranty.

**Important:** Take care to never spill liquids onto the tablet or input tools. Be especially careful of getting the tablet or tool buttons (including the pen tip and eraser) wet – they contain sensitive electronic parts that will fail if liquids enter them.



## REPLACING THE PEN TIP

The pen tip (nib) will wear with normal use. Excessive pressure will cause it to wear sooner. Replace the nib when it gets too short – less than 1 mm (0.04 inch) – or develops a flat point.

1. Unscrew the pen stand base to access the nib extraction tool and replacement nibs.

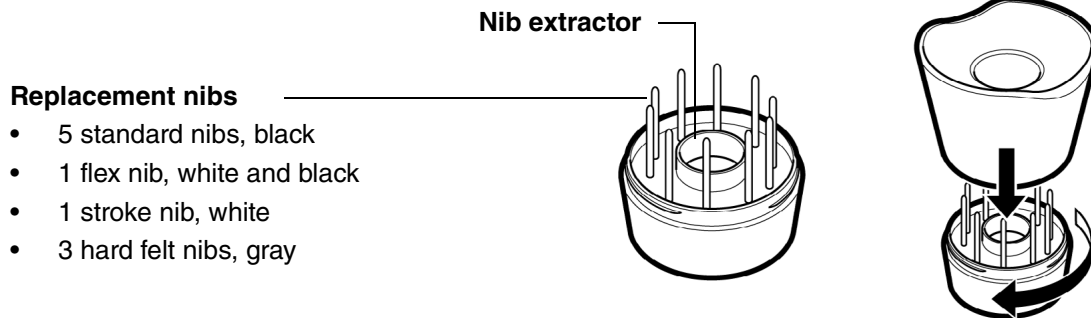

2. Clasp the old nib with the nib extraction tool, pair of tweezers, needle-nosed pliers, or similar instrument and pull it straight out of the pen.

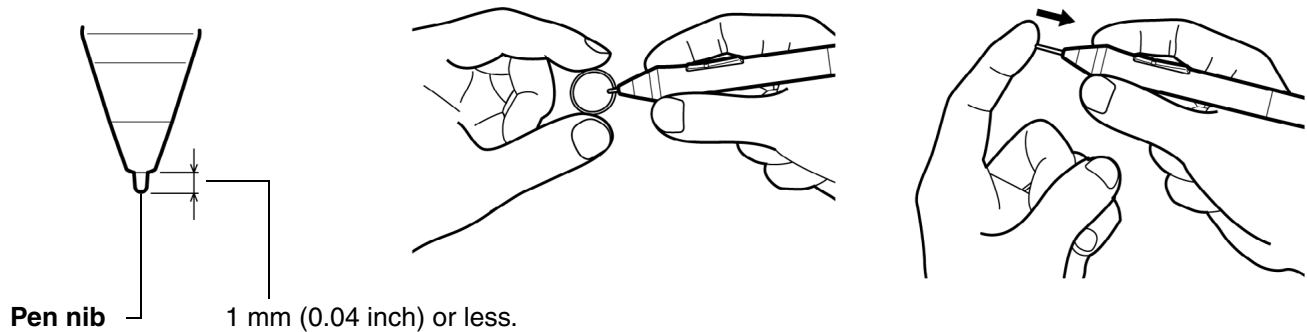

3. Slide the end of the new nib straight into the barrel of the pen. Firmly push the nib until it stops.

**Note:** Stroke nibs are spring-loaded, providing additional tactile feedback when you are working with the Intuos4 pen or Airbrush. They are installed in the same manner as a standard pen nib.

**Warning:** Prevent children from swallowing the pen nib or side switch. The pen nib or side switch may accidentally be pulled out if children are biting on them.

To order replacement parts, see [available parts and accessories](#).

**Important:** When the pen is not in use, place it in the pen stand or lay it flat on your desk. When the optional Airbrush is not in use, lay it flat on your desk. To maintain the sensitivity of your input tools, do not store them in a container where they will rest on their tip or eraser.



## UNINSTALLING THE SOFTWARE

Follow the appropriate procedure below to remove the Wacom tablet driver software from your system.

**Important:** When you remove the Wacom tablet software from your system, your Wacom tablet will no longer operate with full tablet functionality but will continue to function as a mouse device.

**Windows Vista:** Click on the Windows START button and choose CONTROL PANEL. In the CONTROL PANEL window, click on UNINSTALL A PROGRAM. In the dialog box that appears, choose WACOM TABLET. Click UNINSTALL and follow the prompts to remove the tablet driver. (If prompted, enter your administrator login name and password.)

**Windows XP or XP x64:** Click START. In the start menu, select CONTROL PANEL. Then select ADD OR REMOVE PROGRAMS. In the ADD OR REMOVE PROGRAMS window, choose WACOM TABLET and click on the REMOVE button. Follow the prompts to remove the tablet driver.

**Macintosh:** From the GO menu, choose APPLICATIONS and open the WACOM TABLET folder. Double-click on the REMOVE WACOM TABLET icon and select the REMOVE TABLET SOFTWARE button. Enter your administrator login name and password. After the removal is completed, click OK.

## MANAGING YOUR TABLET PREFERENCES

Use the Wacom tablet preferences utility to manage your tablet preferences for a single or multiple users.

**For Windows,** first close any open applications. Then open the utility by clicking the START icon and selecting ALL PROGRAMS. Select WACOM TABLET and TABLET PREFERENCE FILE UTILITY.

- To remove preferences for the current user, click on the REMOVE button under MY PREFERENCES.
- To delete preferences for multiple users, click on the REMOVE button under ALL USER PREFERENCES. Administrator rights are required to delete preferences for all users. Relaunch any currently open tablet-aware applications that you may be running.
- To back up your preferences, click on the BACKUP... button under MY PREFERENCES.
- To restore preferences that you had previously backed up, click on the RESTORE... button under MY PREFERENCES.

Be sure to carefully follow any prompts that may appear.

**To open the utility for Macintosh,** open the main APPLICATIONS folder. Then open the WACOM TABLET folder and run the REMOVE WACOM TABLET utility.

- To remove preferences, select CURRENT USER or ALL USERS. Then click on the REMOVE button. Log out, then log back in. When the tablet driver loads it will create a new preferences file with the factory defaults.
- To back up your preferences, select CURRENT USER or ALL USERS. Then click on the BACKUP... button.
- To restore preferences that you had previously backed up, select CURRENT USER or ALL USERS. Then click on the RESTORE... button.

Be sure to carefully follow any prompts that may appear.

## CHANGING THE TABLET MODE

Within the control panel's TABLET list, double-click on the tablet icon to display the TABLET MODE dialog box. The TABLET MODE setting applies to all tools and applications.

Recommended for graphics applications. This is the default condition.

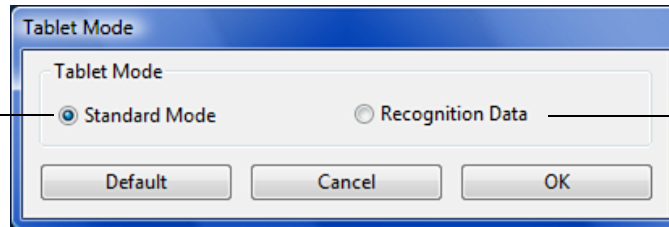

Maximum data rate. Required by some handwriting recognition software.

## INSTALLING MULTIPLE TABLETS

The TABLET list displays an icon for any supported tablet that has been detected on your system, and allows you to select the tablet for which your changes will apply.

To add a new tablet, connect it to your computer.

- For USB tablets, the system searches the USB ports. When the new tablet is found, it is automatically initialized.
- If multiple tablets are installed, the tablet used to open the Wacom Tablet control panel is selected as the default tablet.

Select a tablet icon for which to customize tool and application settings.

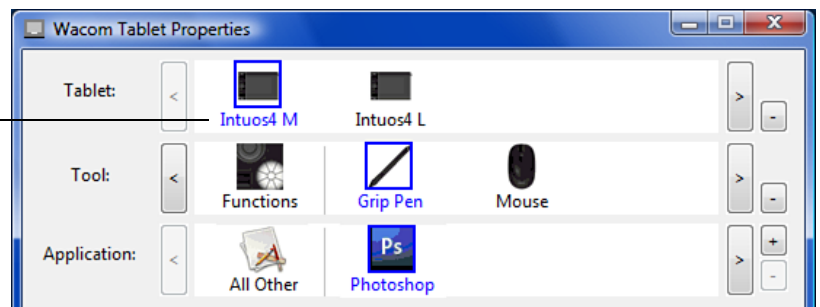

**Important:** When installing additional tablets on Windows systems, please note that the eraser function may not work in some applications when using the additional tablet(s). The eraser function will continue to work correctly using the first tablet that was added to the control panel.

To remove one of multiple tablets from the driver, in the Wacom Tablet control panel select the tablet to be removed and click on the [ – ] button next to the TABLET list. Note that you will need to restart your computer before you can re-add the tablet to the driver.

## ADVANCED OPTIONS

Click on the Wacom Tablet control panel OPTIONS... button to access the advanced OPTIONS dialog box.

The SIDE SWITCH MODE changes the way you use the pen when making right clicks or other click functions. Select:

- HOVER CLICK to perform click functions without touching the pen tip to the tablet surface.



- CLICK & TAP to enable the precise placement of click functions. When selected, you must first press the side switch then touch the pen tip to the tablet surface in order to perform the click function.

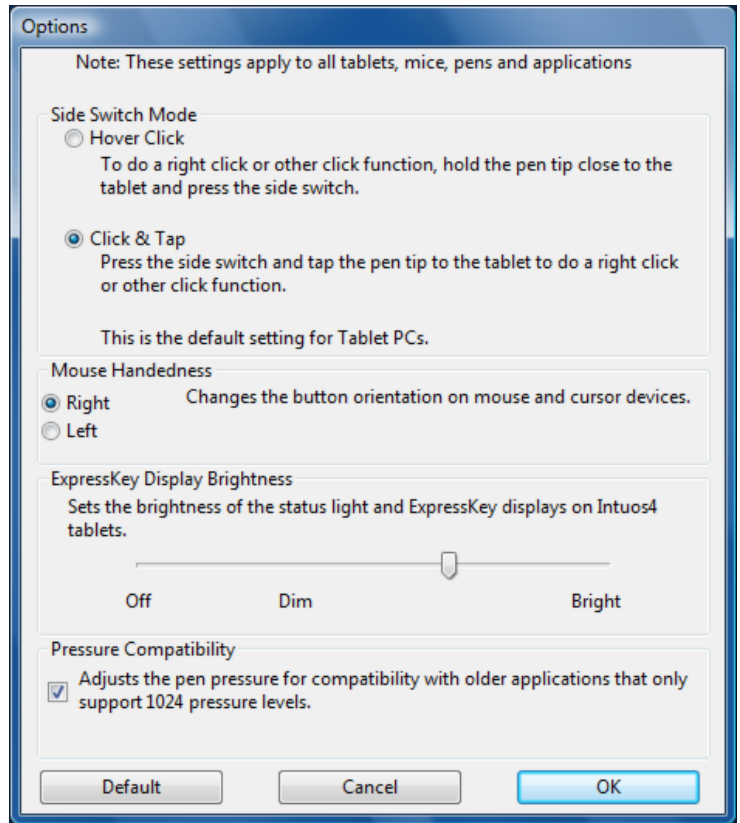

MOUSE HANDEDNESS options change the button orientation on the Intuos4 Mouse and Lens Cursor for right- or left-handed use.

Use the EXPRESSKEY DISPLAY BRIGHTNESS options to set the brightness of the Touch Ring status LEDs and ExpressKeys display on all connected Intuos4 tablets. When the slider is in the left-most position, the Touch Ring status LED brightness is set to low, and the ExpressKeys display is off. See also [optimizing the ExpressKeys display](#).

**Note:** The pen tablet power saving mode will automatically change the brightness of the Touch Ring status LEDs and ExpressKeys display as follows:

5 minutes no user input:	Low brightness
10 minutes no user input:	No illumination, ExpressKeys display Low brightness, Touch Ring status LEDs
Active user input:	Returns brightness to set level

The PRESSURE COMPATIBILITY check box should be checked if you are using graphics applications that only support a maximum of 1024 levels of pressure (such as Adobe CS3, Corel® Painter 9, and other older applications). If not checked, the pen will feel overly sensitive when using these older applications.



## OPTIMIZING THE EXPRESSEKEYS DISPLAY

The pen tablet ExpressKeys display uses Organic Light-Emitting Diodes (OLEDs). Although the display has been designed to provide reliable performance for many years, you may eventually notice a decrease in luminosity for pixels that are lit over extended periods of time. To minimize the appearance of different pixel brightnesses due to this effect, adjust the EXPRESSKEY DISPLAY BRIGHTNESS option to the lowest comfortable light level. See [advanced options](#) for details.

**Note:** The power saving feature of the pen tablet will automatically dim the ExpressKeys display if there has been no user input for 5 minutes, and it will turn off the display if the pen tablet has been idle for 10 minutes.

## USING APPLICATIONS INTEGRATED FOR TABLET CONTROL

Some software applications may be designed to directly control the pen tablet ExpressKeys or Touch Ring function(s). When working in an application that has been integrated in this manner, the ExpressKeys or Touch Ring may perform a different function than what is currently set in the Wacom Tablet control panel.

- When an ExpressKey is overridden by an application, the ExpressKeys display will automatically update to show either the new function name or “Application Defined”. Some or all of the ExpressKeys may be overridden, depending on the application.
- When an application overrides the Touch Ring, all Touch Ring functions are affected. If an application overrides only one, two, or three of the available Touch Ring functions, the remaining function(s) are set to SKIP.
- An integrated application will control the ExpressKeys or Touch Ring only when that application is active and in the foreground. When you close that application (or select a new application pane to work in), your Wacom Tablet control panel settings are returned to their previous state.
- To review the ExpressKeys or Touch Ring function settings for the current front-most application, set an ExpressKey to SHOW SETTINGS and press the key at any time.

Applications that have been integrated in this manner will typically provide you with the opportunity to opt-out or disable this functionality when first using your Wacom pen tablet with the application. See the documentation provided with your application for any specific details on functionality and how to customize or disable this feature.

If an automatic prompt or the application’s documentation does not describe how to disable this behavior, you can use the Wacom Tablet control panel to create application-specific settings which will override the behavior of the integrated application.

See [application-specific settings](#) for information on creating application-specific settings.

**Important:** If an application-specific setting has been created for an integrated application, setting an ExpressKey or Touch Ring function to APPLICATION DEFINED will allow the integrated application to control the function.

## USING THE OPTIONAL AIRBRUSH AND ART PEN

The optional Intuos4 Airbrush works like the Grip Pen, but also includes a fingerwheel for an additional degree of control.

With proper software support, you can simulate realistic airbrushing. For example, tilting the Airbrush can cause the spray pattern to elongate and feather out. Rolling the fingerwheel adjusts the spray intensity, and pressure on the tip controls the brush size.

Hold the Airbrush with your thumb and middle finger. The fingerwheel should be in a convenient location for you to roll it with your index finger. Tilt the Airbrush to find a comfortable position that allows you to paint and draw with pressure sensitivity.

### Side switch

The default settings are:

Windows: RIGHT CLICK

Macintosh: DOUBLE CLICK

### Fingerwheel

Roll the fingerwheel backwards to increase ink flow or brush size, and forward to reduce it.

Your index finger should operate the wheel independently of the pressure you apply to the tip.

### Replaceable nib

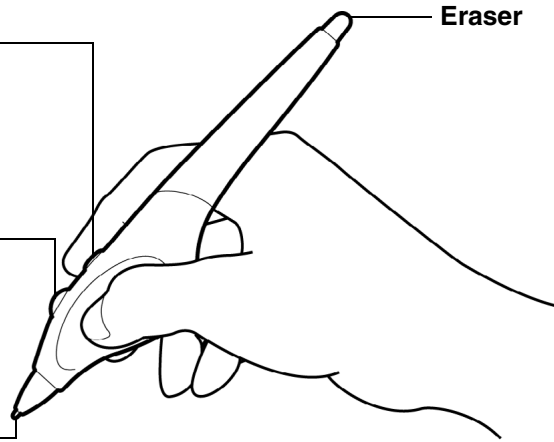

The optional Intuos4 Art Pen responds to the pressure, tilt, and rotation you apply to the pen.

### Side switches

The default settings are:

Upper: DOUBLE CLICK

Lower: RIGHT CLICK

### Eraser

Does not support rotation.

The Art Pen supports 360 degrees of rotation around the pen axis. As you draw within an application that supports rotation sensitivity, simply twist the Art Pen to create lines that narrow or broaden.

For example, while painting you can vary the rotation of a non-circular brush to change the stroke thickness. Depending on the brush shape characteristics you have selected in your application, you can simulate calligraphy pens, broad felt tip markers, and any other non-circular brushes or tools.

### Replaceable nib

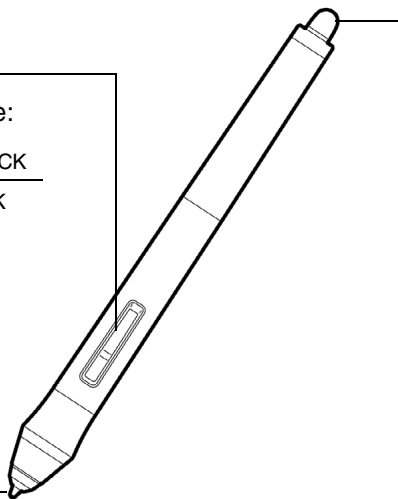

**Important:** When the Airbrush or Art Pen is not in use, lay it flat on your desk. To maintain the sensitivity of your tool, do not store it in a container where it will rest on its tip or eraser. Leaving an Intuos4 tool on the tablet may interfere with screen cursor positioning when using other pointing devices.

See [product information](#) to learn more about which applications currently support the Airbrush fingerwheel or Art Pen rotation. See [ordering parts and accessories](#) for information on where to purchase an Intuos4 Airbrush or Art Pen.

## INTUOS4 LENS CURSOR

Available for Intuos4 L and XL tablet models, the lens cursor is an ideal tool for entering precise coordinate position information into your computer. The lens cursor reports the position of the cross-hair to the computer. This makes the lens cursor especially useful for digitizing drawings into graphics and CAD applications.

**Lens**

Rotate for best viewing angle.

**Left button**

This is the primary button used to CLICK and select.

The default button positions are:

Left:	CLICK
Right:	RIGHT CLICK
Middle:	MIDDLE CLICK
Left rear:	BACK
Right rear:	FORWARD

See also [customizing the lens cursor](#).

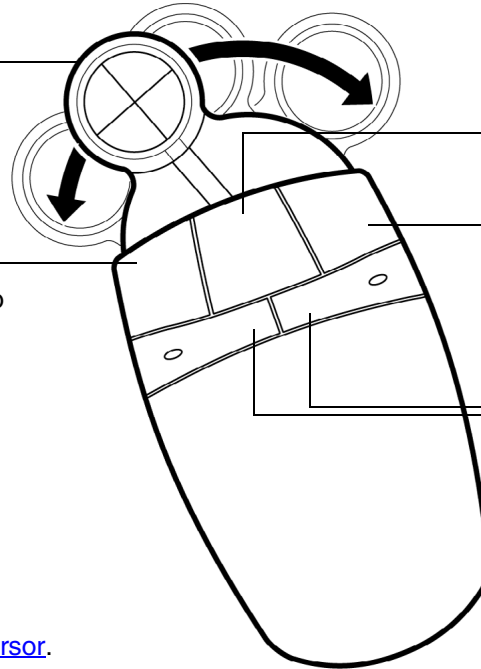

**Middle button**

Press to perform a MIDDLE CLICK.

**Right button**

Displays a context menu when pressed.

**Left and right rear buttons**

These are set for BACK and FORWARD functionality within your Internet browser.

The default setting for the Intuos4 Lens Cursor is MOUSE MODE, enabling you to move the screen cursor with a “pick up and slide” action similar to using a traditional mouse. When using the lens cursor to digitize a drawing, the lens cursor must be set to PEN MODE.

**Important:** When the lens cursor is not in use, place it on your desk. Leaving an Intuos4 tool on the tablet may interfere with screen cursor positioning when using other pointing devices.

For order information on this and other available Intuos4 tools, see [ordering parts and accessories](#).

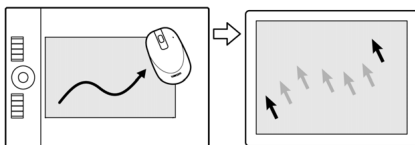

[Mouse mode settings](#)

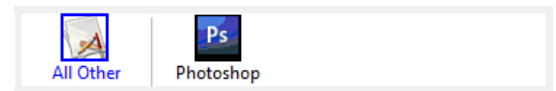

[Application-specific settings](#)



## CUSTOMIZING THE LENS CURSOR

To modify your Intuos4 Lens Cursor button settings, use your lens cursor to open the Wacom Tablet control panel and select the **MOUSE** tab. Then select a [function](#) to perform for each button from the pull-down menus.

The buttons are chordable; you can press two or more buttons simultaneously. For example, if you program one button to simulate the CTRL key and another to simulate an ALT keystroke, when you press both buttons a CTRL+ALT is simulated.

**Note:** To configure the lens cursor for left-handed use, simply reassign the button functions as needed.

## TESTING THE LENS CURSOR

1. With the **DIAGNOSTICS** dialog box open, place the Intuos4 Lens Cursor on the tablet active area and test the buttons by clicking each button. A tablet status LED should brighten, and the **SWITCHES** state should change for each button you click.

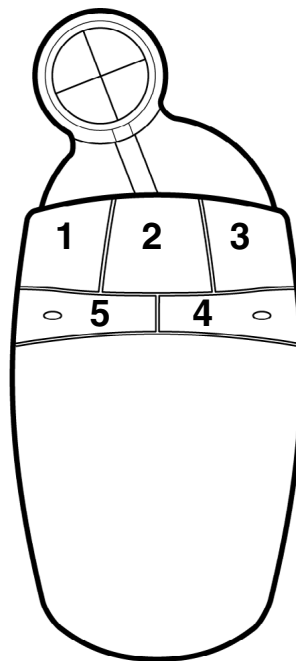

2. When you are done, click on the **CLOSE** button to exit the dialog box.



## WORKING WITH AUTOCAD

AutoCAD can support the Intuos4 tablet as a Windows system pointing device or as a Wintab compatible digitizer. By default, AutoCAD is configured to use Intuos4 as a system pointing device.

Follow the below procedures if you will be using Intuos4 with tablet menus or to digitize drawings to proper scale.

**Note:** To configure the mouse or lens cursor for left-handed use in AutoCAD or similar applications, open the Wacom Tablet control panel, click on OPTIONS... and select LEFT in the MOUSE HANDEDNESS group.

[Configuring AutoCAD for a Wintab compatible digitizer](#)

[Configuring tablet menus and screen pointing areas in AutoCAD](#)

[Calibrating Intuos4 for AutoCAD](#)

## CONFIGURING AUTOCAD FOR A WINTAB COMPATIBLE DIGITIZER

1. Start AutoCAD. Open the TOOLS menu and select OPTIONS. (In AutoCAD 2009 or later, click on the button with the red 'A' on the top left and select OPTIONS.)
2. From the OPTIONS window, select the SYSTEM tab.
3. Under CURRENT POINTING DEVICE, select the WINTAB COMPATIBLE DIGITIZER option.
4. Decide from which device AutoCAD will accept input. Choose an option from the ACCEPT INPUT FROM section:
  - **DIGITIZER ONLY.** The AutoCAD drawing editor only accepts input from Intuos4.
  - **DIGITIZER AND MOUSE.** The AutoCAD drawing editor accepts input from both Intuos4 and your mouse.
5. Click OK to close the OPTIONS window.

## CONFIGURING TABLET MENUS AND SCREEN POINTING AREAS IN AUTOCAD

A screen pointing area is a rectangular region on the tablet surface where the tablet acts like a system mouse. When the pointer is within a screen pointing area, the tablet can access windows, menus, and other applications outside AutoCAD's drawing area. You can configure both a fixed and floating screen pointing area.

Before you configure the tablet, its entire surface is the fixed screen pointing area. AutoCAD recommends changing the size of the fixed screen pointing area so that a small screen area on your tablet maps to the entire monitor screen. AutoCAD also recommends selecting the default tablet menus, columns, and rows they provide.

After you configure the tablet menus, AutoCAD prompts you for the fixed and floating screen pointing areas. This allows you to designate a tablet area as a Windows system pointer.

The fixed screen pointing area is disabled when you digitize points into AutoCAD with TABLET MODE ON. This is due to the fixed correspondence between the tablet and AutoCAD's drawing area. To access menus from the tablet, you must use the floating screen pointing area. This allows you to access a menu from anywhere on the tablet surface, and to toggle it off when finished. You can define a tool button to toggle the floating screen area on and off.

**Important:** The floating screen pointing area takes precedence over menu areas, TABLET MODE ON, and the fixed screen pointing area.

1. From the DRAWING EDITOR, open the TOOLS menu (OPTIONS menu for Release 13).
2. Select TABLET, and then CONFIGURE. (In AutoCAD 2009 or later, enter 'tablet cfg' directly at the command prompt.)
3. Define tablet menu areas. Follow the prompts at the bottom of the AutoCAD Drawing Editor. Type the number of tablet menu areas you want (0-4) and press ENTER. If you do not want to use a menu template, type 0 (zero). Digitize the upper-left, lower-left, and lower-right corners of the menu area and then press ENTER. Next, enter the number of columns and press ENTER. Now enter the number of rows and press ENTER. Repeat for each menu area.
4. Define the fixed screen pointing area. By default, the entire tablet is a fixed screen pointing area. If you are using a menu template, you should re-specify the fixed screen pointing area to match the template. Continue to follow the prompts at the bottom of the AUTOCAD DRAWING EDITOR screen.
5. Define the floating screen pointing area – it allows you to access all areas of the screen. The floating screen pointing area takes precedence over TABLET MODE ON, the fixed screen pointing area, and the menu areas. Continue to follow the prompts at the bottom of the AUTOCAD DRAWING EDITOR screen.

Please check your AutoCAD documentation for additional information.

## CALIBRATING INTUOS4 FOR AUTOCAD

If you are using Intuos4 to digitize a drawing, you will need to calibrate Intuos4 with the paper drawing's coordinate system. The calibration allows you to digitize points from the paper drawing into the appropriate coordinate system of your drawing file.

1. From the DRAWING EDITOR, open the TOOLS menu (OPTIONS menu for Release 13).
2. Choose the TABLET and CALIBRATE options. (In AutoCAD 2009 or later, enter 'tablet cal' directly at the command prompt.) Then:
  - Digitize point #1 on the paper drawing. Then enter the xy coordinate from the paper drawing at the digitized point.
  - Digitize point #2 on the paper drawing. Then enter the xy coordinate from the paper drawing at the digitized point.
  - Digitize more points if necessary. More than four points may take more time than expected for AutoCAD to compute the best-fitting projective transformation.
3. Press ENTER when you are done.

When Intuos4 has been configured as a digitizer and calibrated, you can use CTRL+T to toggle between using Intuos4 as a digitizer and as a Windows system pointer.

## PEN AND DIGITAL INK CAPABILITIES IN WINDOWS VISTA

Microsoft Windows Vista provides extensive support for pen\* and touch input. When using the professional pen tablet with a computer running Windows Vista, your experience is enhanced by powerful note taking, handwriting recognition, fast navigation, and other digital inking options designed to give you quick, intuitive results with the Intuos4 pen.

- **Note taking.** Use your Intuos4 pen to jot notes and capture quick sketches in Microsoft Journal. Journal simulates a physical notebook, but with the advantages of digital note taking – you can choose from a variety of pen, marker, and highlighter tools, plus an eraser that is easily activated by the eraser of your Intuos4 pen. Journal also includes a powerful search engine that can even locate your handwritten content.
- **Handwriting recognition.** Because Windows Vista includes powerful handwriting recognition capabilities, you can use your Intuos4 pen to quickly enter handwritten information anywhere the computer accepts typed input. You can convert your handwritten content to typed text at any time.
- **Gestures.** Use your Intuos4 pen to make simple gestural movements on the tablet to trigger customizable actions for navigation, editing, and other functions. To customize your gestures, select the FLICKS tab in the PEN AND INPUT DEVICES control panel.
- **Digital Ink in Microsoft Office 2007.** Use your Intuos4 pen to full advantage with the enhanced digital mark-up and inking tools available in Microsoft Office 2007 applications running on Windows Vista. Found on the REVIEW tab within applicable applications, these tools provide a consistent set of inking options. For quick access, you can add specific inking tools to the Quick Access Toolbar located at the top of each application.

To make the most of the pen in Microsoft Windows Vista, be sure to study the documentation that came with your system, including the Windows Vista training tools and Tablet PC tutorial. You can access the Tablet PC Pen Training from the Vista START menu by choosing ALL PROGRAMS, TABLET PC, and TABLET PC PEN TRAINING.

**Note:** The following workarounds in the pen tablet driver improve drawing performance in Vista:

- The Vista Pen Flicks and 'press-and-hold-to-right-click' features are disabled in graphics applications using the Wintab API.
- There is no pressure sensitivity in Journal and other Vista Ink features when both the Flicks and 'press-and-hold-to-right-click' features are disabled in the Vista PEN AND INPUT DEVICES control panel.

\* Pen features supported in all versions of Windows Vista except Vista Home Basic.





## ABOUT THE WINDOWS VISTA TABLET PC INPUT PANEL

The Input Panel enables you to use handwriting or an on-screen keyboard to directly enter text with your Intuos4 pen. There are different ways to launch the Input Panel:

- Click on the Input Panel icon which appears when you move the screen cursor into a text entry area.
- Click on the Input Panel tab, located by default on the left edge of the display screen.
- Click on the Tablet PC Input Panel icon located on the Windows taskbar. If the icon is not visible, right-click on the taskbar, select TOOLBARS, and TABLET PC INPUT PANEL.

To customize the Input Panel:

1. First open the Input Panel and then click on TOOLS in the menu bar.
2. Select OPTIONS to open the Input Panel Options dialog box.
3. Customize the Input Panel settings for the way you like to work.

To learn more about using your Intuos4 pen in Microsoft Windows Vista and Office 2007, study the documentation that came with your system and Microsoft Office applications. Be sure to take advantage of the Windows Vista training tools, including the Tablet PC tutorial, available from Microsoft.

You can also visit our web site at [www.wacom.com/vista](http://www.wacom.com/vista) for more information on working with your Intuos4 pen in Windows Vista.



## PRODUCT SPECIFICATIONS

### GENERAL SPECIFICATIONS FOR ALL INTUOS4 TABLETS

Aspect ratio	16 : 10
Coordinate resolution	200 lpmm (5080 lpi)
Accuracy, pen	+/- 0.25 mm (0.010 in)
Accuracy, mouse	+/- 0.5 mm (0.020 in)
Accuracy, lens cursor	+/- 0.15 mm (0.006 in) (PTK-1240), +/- 0.25 mm (0.01 in) (PTK-840)
Tilt range (all pens)	+/- 60 degrees (+/- 50 degrees on Intuos4 S tablets)
Reading height	10 mm (0.39 in)
Maximum report rate	200 points per second
ExpressKeys stroke	0.25 mm (0.01 in), approximately
Communication interface	USB
Connector	USB Type A to USB mini-B (Intuos4 S, M, and L tablet models) USB Type A (Intuos4 XL)
Cable length	2.5 m (8.2 ft)
Power requirements	DC 5V, less than 300 mA, from primary USB port or powered USB hub
Operating temperature	5 to 40 degrees C (41 to 104 degrees F)
Storage temperature	-15 to +60 degrees C (5 to 140 degrees F)
Operating relative humidity	30% to 80% non-condensing
Storage relative humidity	30% to 85% non-condensing
Certification and compliance	FCC class B, CE, VCCI Class B, Industry Canada Class B, BSMI, C-Tick, MIC, GOST-R, RoHS, Chinese RoHS

### INTUOS4 S TABLET (MODEL PTK-440)

Active area (W x D)	157.5 x 98.4 mm (6.2 x 3.9 in)
Physical size (W x D x H)	309 x 208 x 12 mm (12.2 x 8.2 x 0.5 in), approximately
Weight	700 g (1.54 lb), approximately

### INTUOS4 M TABLET (MODEL PTK-640)

Active area (W x D)	223.5 x 139.7 mm (8.8 x 5.5 in)
Physical size (W x D x H)	370 x 254 x 12 mm (14.6 x 10.0 x 0.5 in), approximately
Weight	1 kg (2.2 lb), approximately



## INTUOS4 L TABLET (MODEL PTK-840)

Active area (W x D)	325.1 x 203.2 mm (12.8 x 8.0 in)
Physical size (W x D x H)	474 x 320 x 14 mm (18.7 x 12.6 x 0.6 in), approximately
Weight	1.8 kg (3.96 lb), approximately

## INTUOS4 XL TABLET (MODEL PTK-1240)

Active area (W x D)	487.7 x 304.8 mm (19.2 x 12.0 in)
Physical size (W x D x H)	623 x 462 x 28 mm (24.5 x 18.2 x 1.1 in), approximately
Weight	3.5 kg (7.72 lb), approximately

## INTUOS4 GRIP PEN (MODEL KP-501E)

Pen tip travel	0.2 mm (0.01 in) or less
Pressure levels	2048 levels
Eraser tip travel	1.5 mm (0.06 in), approximately
Physical size (L x D)	156.5 x 14.9 mm (6.17 x 0.59 in)
Weight	18g (0.63 oz), approximately

## INTUOS4 MOUSE (MODEL KC-100)

Physical size (L x D x H)	102.9 x 61.8 x 38.6 mm (4.05 x 2.43 x 1.52 in)
Weight	83 g (2.9 oz), approximately
Button stroke	Less than 1.3 mm (0.05 in), approximately
Fingerwheel type	Rotation, 24 steps per revolution

## INTUOS4 AIRBRUSH (MODEL KP-400E)

Pen tip travel	0.2 mm (0.01 in) or less
Fingerwheel travel	10 mm (0.39 in)
Fingerwheel resolution	1024 levels, approximately
Pressure levels	2048 levels
Eraser tip travel	1.5 mm (0.06 in), approximately
Physical size (L x W x D)	162.5 x 17.5 x 32.5 mm (6.40 x 0.69 x 1.28 in)
Weight	23.0 g (0.81 oz), approximately

The Airbrush is an optional accessory.





## INTUOS4 INKING PEN (MODEL KP-130)

Pen tip travel	0.2 mm (0.008 in) or less
Pressure levels	2048 levels
Physical size (L x D)	151.5 x 12.5 mm (5.97 x 0.49 in)
Weight	12 g (0.42 oz), approximately

The Inking Pen is an optional accessory.

## INTUOS4 ART PEN (MODEL KP-701E)

Pen tip travel	0.2 mm (0.008 in) or less
Pressure levels	2048 levels
Eraser tip travel	1.5 mm (0.06 in), approximately
Barrel rotation	360 degrees
Physical size (L x W x D)	156.3 x 15.5 x 15.9 mm (6.16 x 0.61 x 0.63 in)
Weight	20 g (0.7 oz), approximately

The Art Pen is an optional accessory.

## INTUOS4 CLASSIC PEN (MODEL KP-300E)

Pen tip travel	0.2 mm (0.01 in) or less
Pressure levels	2048 levels
Eraser tip travel	1.5 mm (0.06 in), approximately
Physical size (L x D)	150.7 x 12.2 mm (5.94 x 0.48 in)
Weight	12 g (0.42 oz), approximately

The Classic Pen is an optional accessory.

## INTUOS4 LENS CURSOR (MODEL KC-210)

Physical size (L x D x H)	159 x 66 x 33.8 mm (6.26 x 2.60 x 1.33 in)
Weight	75 g (2.65 oz), approximately
Button stroke	Less than 1.3 mm (0.05 in), approximately

Compatible with Intuos4 L and XL tablet models only.



## PRODUCT INFORMATION

To learn more about Intuos4, and about which software applications are currently tablet enhanced to support the pressure sensitivity, tilt sensitivity, eraser, and other special functionality of your professional pen tablet and tools, visit the Wacom web site for your region:

USA, Canada, Central and South America	<a href="http://www.wacom.com/productinfo">http://www.wacom.com/productinfo</a>
Europe, Middle East and Africa	<a href="http://www.wacom.eu">http://www.wacom.eu</a>
Japan	<a href="http://tablet.wacom.co.jp">http://tablet.wacom.co.jp</a>
Asia Pacific (English)	<a href="http://www.wacom-asia.com">http://www.wacom-asia.com</a>
China (Simplified Chinese)	<a href="http://www.wacom.com.cn">http://www.wacom.com.cn</a>
Korea	<a href="http://www.wacomkorea.com">http://www.wacomkorea.com</a>
Taiwan	<a href="http://www.wacom.com.tw">http://www.wacom.com.tw</a>
Thailand	<a href="http://www.wacom-thai.com">http://www.wacom-thai.com</a>

## ORDERING PARTS AND ACCESSORIES

Your Intuos4 professional pen tablet is the ultimate master tool for creative professionals. The tablet, combined with your Intuos4 Grip Pen and other available Intuos4 tools, enables you to paint more intuitively, illustrate better, and edit imagery faster than ever before. Each Intuos4 Grip Pen or accessory tool features Tool ID, which means they always remember your preferences and work together seamlessly.

To expand the feature set of your Intuos4 product, look over the [available parts and accessories](#) described on the following pages. Please note that not all parts and accessories are available in all regions.

To purchase parts and accessories, refer to the tablet Read Me file and see who to call for your region.

You can also do the following:

**To purchase parts and accessories in the USA or Canada**, call 1.888.884.1870 (toll-free) or visit Wacom's web site at <http://www.WacomDirect.com> (USA only).

**To purchase parts and accessories in Europe**, call +49 (0)180.500.03.75 or send an email to [spareparts@wacom.eu](mailto:spareparts@wacom.eu). Or, visit <http://shop.wacom.eu>. You can also contact your local dealer, distributor, or technical support using the appropriate number for your region.

**To purchase parts and accessories in Australia, Singapore, Taiwan and Korea**, please visit: [www.BuyWacom.com.au](http://www.BuyWacom.com.au), [www.BuyWacom.com.sg](http://www.BuyWacom.com.sg), [www.BuyWacom.com.tw](http://www.BuyWacom.com.tw) and [www.BuyWacom.co.kr](http://www.BuyWacom.co.kr), respectively.

**To purchase parts and accessories in other countries**, please contact your local dealer or distributor.

## AVAILABLE PARTS AND ACCESSORIES



**Intuos4 Grip Pen (KP-501E).** Sensitive to pressure and tilt, the Grip Pen is an all-purpose tool for drawing, erasing, and mouse operations. The easy-to-use DuoSwitch gives you two programmable switch functions. The pressure-sensitive pen has an ergonomic, waisted and rubberized grip area, optimum weight and balance, and superior tip sensitivity, making it the most natural freehand tool. Includes the following accessories: Pen stand, standard nib (qty 1), stroke nib (qty 1), hard felt nib (qty 1), and flex nib (qty 1).

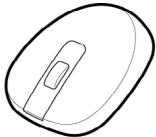

**Intuos4 Mouse (KC-100).** Cordless and battery free, the five button mouse is an ideal tool for performing any task you may have done previously with a standard mouse. It includes an integrated middle button and rolling fingerwheel that can be used for up and down scrolling, or the button can be programmed for a variety of other actions.



**Intuos4 Airbrush (KP-400E).** A true digital airbrush, the pressure-sensitive [Intuos4 Airbrush](#) incorporates a pressure-sensitive tip and eraser, tilt sensitivity, and a fingerwheel that provides an additional degree of control over the application of digital paint. Includes the following accessories: Pen stand, standard nib (qty 1), stroke nib (qty 1), hard felt nib (qty 1), and flex nib (qty 1).

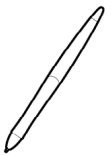

**Intuos4 Inking Pen (KP-130).** This pressure- and tilt-sensitive drawing pen was created to provide immediate feedback at your pen tip on the drawing as well as on your computer screen. The pressure-sensitive Inking Pen comes with inking cartridges and two polyacetal tips for inkless drawing. It has a pressure-sensitive tip, but no eraser and no side switches. Includes the following accessories: Pen stand, standard nibs (qty 2), inking nibs (black, qty 3).

**Note:** When you purchase an Inking Pen, it comes with a polyacetal nib in the pen. Use the nib extractor (silver ring) to gently remove the polyacetal nib from the pen. Then insert one of the silver-colored cartridges that come with the Inking Pen. The cartridge tip has a waxy coating that you will need to rub off before you can begin inking.

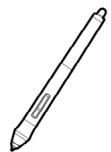

**Intuos4 Art Pen (KP-701E).** This specialty pen provides 360 degrees of barrel rotation and, like the Intuos4 Grip Pen, is pressure and tilt sensitive. Combining these features with a unique chisel-shaped nib makes the Intuos4 Art Pen the most realistic tool for emulating brushes, markers, and calligraphic pens. Includes the following accessories: Pen stand, chisel tipped nibs (qty 2), chisel tipped felt nibs (qty 2), bullet tipped nibs (qty 3), and bullet tipped felt nibs (qty 3).

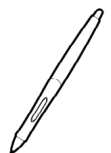

**Intuos4 Classic Pen (KP-300E).** This pen has the same feature set as the Intuos4 Grip Pen, but with a slimmer profile that does not include a rubberized grip. Includes the following accessories: Pen stand, standard nib (qty 1), stroke nib (qty 1), hard felt nib (qty 1), and flex nib (qty 1).



**Intuos4 Lens Cursor (KC-210).** Compatible with Intuos4 L and XL tablet models only, the lens cursor is a precise coordinate position input tool. It is ideal for digitizing drawings, for CAD processes, or for vector design applications where the precise input of coordinate information is critical. The moveable lens can be swung from left to right for comfortable positioning while you work.



Description	Part Number
-------------	-------------

**Replacement nibs for Grip Pen, Airbrush, or Classic Pen**

Standard nib – firm, plastic nib, black, qty 5	ACK-20001
Stroke nib – spring loaded nib, more of a “brush-like” feel, qty 5	ACK-20002
Felt nib – softer nib, for a “pencil or marker on paper” feel, qty 5	ACK-20003
Flex nib – a flexible, elastomeric nib, that provides a “higher friction” feel, qty 5	ACK-20004

Felt nib, chisel tip, qty 5	ACK-20005
-----------------------------	-----------

Nib set, for Art Pen	ACK-20006
----------------------	-----------

Pen grip, standard	ACK-30001
--------------------	-----------

Pen grip, thick bodied grip for pen use without side switch.	ACK-30002
--	-----------

Pen grip, standard for pen use without side switch.	ACK-30003
---	-----------

Intuos4 Grip Pen accessory kit.	ACK-40001
---------------------------------	-----------

**Tablet surface sheet replacements**

Small, standard	ACK-10011
Medium, standard	ACK-10021
Large, standard	ACK-10031
Small, clear	ACK-10012
Medium, clear	ACK-10022
Large, clear	ACK-10032
Extra large, clear	ACK-10042

For order information, see [ordering parts and accessories](#).



## RADIO AND TELEVISION INTERFERENCE

The equipment described in this manual generates, uses, and can radiate radio-frequency energy. If it is not installed and used properly—that is, in strict accordance with Wacom instructions—it may cause interference with radio and television reception.

### FCC NOTICE

This device complies with Part 15 of the FCC Rules. Operation is subject to the following two conditions: (1) this device may not cause harmful interference, and (2) this device must accept any interference received, including interference that may cause undesired operation.

This equipment has been tested and found to comply with the limits for a Class B digital device, pursuant to Part 15 of FCC Rules. These limits are designed to provide reasonable protection against harmful interference in a residential installation.

This equipment generates, uses and can radiate radio frequency energy and, if not installed and used in accordance with the instructions, may cause harmful interference to radio communications. However, there is no guarantee that interference will not occur in a particular installation.

You can determine whether the equipment is causing interference by disconnecting it from your computer. If the interference stops, it was probably caused by the equipment.

If the equipment does cause interference to radio or television reception, you may be able to correct the interference by using one or more of the following measures:

- Rotate the television or radio antenna until the interference stops.
- Move the equipment farther away from the television or radio.
- Plug the equipment and computer into an outlet that is on a different circuit from the television or radio.

If necessary, consult your Wacom dealer or an experienced radio/television technician for help.

Changes or modifications to this product not authorized by Wacom could void the FCC Certification and negate your authority to operate the product.

### INDUSTRY CANADA (CANADA ONLY)

“This Class (B) digital apparatus complies with Canadian ICES-003”

“Cet appareil numérique de la classe (B) est conforme à la norme NMB-003 du Canada.”







## CE DECLARATION

The Intuos<sup>®</sup> 4 digitizing tablets, models PTK-440, PTK-640, PTK-840, and PTK-1240 have been tested and found to comply with the following harmonized European Norms:

- EN55022: 2006 Class B
- EN61000-3-2: 2006
- EN61000-3-3: 1995/A1:2001/A2:2005
- EN55024: 1998/A1:2001/A2:2003
  - IEC61000-4-2: 1995
  - IEC61000-4-3: 1995
  - IEC61000-4-4: 1995
  - IEC61000-4-5: 1995
  - IEC61000-4-6: 1996
  - IEC61000-4-8: 1993
  - IEC61000-4-11: 1994

Based on the results of these tests, Wacom declares that the above mentioned devices conform to the EMC Directive 2004/108/EC.

The device must be installed and operated always in strict accordance with the instructions given in this handbook.

Any changes or modifications to this product that were not specifically authorized by Wacom will invalidate this declaration.



## PRECAUTIONS

### WARNINGS

**Do not place or leave the pen tablet or input tool(s) within reach of children. If your product is used improperly there is a potential for accident or human injury.** Prevent children from swallowing the pen nib or side switch. The pen nib, side switch, or other movable parts may accidentally be pulled out if children are biting on them. Small parts, such as the pen nib or nib refills, pen side switch, or tablet pen stand, can be removed and accidentally swallowed by children.

**Do not use the pen tablet in a facility control system that requires extremely high reliability.** It may cause other electronic devices to malfunction, or other devices may cause the pen tablet to malfunction.

**Power off your pen tablet in locations where/when electronic devices are not allowed.** Because the pen tablet may cause other electronic devices to malfunction in some locations where/when the use of electronic devices is not allowed, such as within an airplane, be sure to turn off the pen tablet by unplugging the USB connector of this product from your computer.

**Do not disassemble the pen tablet or input tool(s).** Do not disassemble or otherwise modify the pen tablet or input tool(s). Such action may cause heat generation, ignition, electrical shock, or other damage, including human injury. Disassembly of the product will void your warranty.

**Take note of damaged cabling.** If you notice that your pen tablet cabling is torn or otherwise damaged, there is a potential for product malfunction, electrical shock, or fire. Stop using the product and contact your local distributor or the Wacom customer support center for your region.

**Do not expose this product to water or other liquids.** Take care to never spill liquids onto the pen tablet or input tool(s). Exposing this product to water or other liquids may cause product malfunction or electrical shock. If the product is exposed to water or other liquids, unplug the USB connector. If your product is equipped with a power cord, unplug the cord from the wall outlet. Power down your computer. Then disconnect any other cables that may remain between the pen tablet and your computer. Stop using the product and contact your local distributor or the Wacom customer support center for your region.

**Do not insert foreign material into the USB port or any other opening of this product.** If a metal object or foreign material is inserted into the USB port or other opening of this product, it may cause the product to malfunction or burn out, or cause electrical shock.

### CAUTIONS

**Do not place or use this product on an unstable surface or workspace.** Do not place this product on a shaky, inclined, or vibrating surface. It may drop or fall off, causing damage to the product or human injury.

**When cleaning your pen tablet, power off the unit by unplugging the USB connector from between the pen tablet and your computer.** Electrical shock may occur if you attempt to clean this product when it is connected to your computer.

#### Further precautions regarding your pen tablet:

- Do not apply heavy stress to the pen tip, eraser, or side switch. It may shorten pen tip life or may cause the pen to malfunction.
- If a distorted or bent pen nib is used, the pen tool may operate improperly. Therefore, do not apply excessive force when using the pen.
- Using a pen nib other than one specifically designed by Wacom for your pen input tool may cause product malfunction.
- Do not place metal objects on this product when it is in use. Metal objects placed on the pen tablet during use may cause interference, improper operation, or product malfunction.

## LICENSE AND WARRANTIES

(WORLDWIDE, EXCEPT FOR EUROPE, AFRICA AND MIDDLE EAST)

### SOFTWARE LICENSE

This legal document is an agreement between you, the end-user, and Wacom Technology Corporation (Wacom).

- 1. Grant of License.* The enclosed product includes computer programs embedded in firmware and accompanying diskette or CD-ROM (the "Software"). The Software is licensed, not sold, to you for use only with Wacom products upon the terms of this license, and Wacom reserves any rights not expressly granted to you. Wacom grants to you a non-exclusive right to use this copy of the Software in conjunction with a Wacom product at a single location.
- 2. Ownership of Software.* Although you may own the product in which the Software is originally recorded, Wacom retains ownership of the Software itself. You acknowledge that the Software is Wacom's property, and contains valuable confidential, unpublished information developed or acquired by Wacom at great expense, including data processing algorithms, innovations and concepts. The Software is protected by copyright and other federal and state laws. You agree to use your reasonable best efforts to protect the Software from unauthorized reproduction, distribution, disclosure, use, or publication.
- 3. Copy Restrictions.* Unauthorized copying of the Software is expressly forbidden.
- 4. Use Restrictions.* You may not decompile, reverse assemble, disassemble or reverse engineer the Software.
- 5. Termination.* This License is effective until terminated. This License will terminate automatically without notice from Wacom if you fail to comply with any provisions of the License.
- 6. Miscellaneous.* This License is governed by the laws of the United States of America and the state of Washington except in Asia Pacific and by the laws of Japan for Asia Pacific.

### LIMITED WARRANTY

(U.S.A. AND CANADA)

Wacom warrants the product, to the original consumer purchaser, except for the Software and consumable items such as the pen nibs, to be free from defects in materials and workmanship under normal use and service for a period of two (2) years, from the date of original retail purchase, as evidenced by a copy of the receipt and registration with Wacom within 30 days of purchase.

The Software is licensed "as is." Wacom makes no warranty with respect to its quality or performance. Wacom cannot guarantee you uninterrupted service or the correction of any errors.

*Upon discovery of a defect in the product, except in the Software, within the Warranty Period, you should contact Wacom Technical Support via telephone, email, or fax to obtain an RMA (Return Merchandise Authorization) number and instructions for shipping the product to a service location designated by Wacom. You should send the product, shipping charges prepaid, to the designated service location, accompanied by the return authorization number, your name, address and telephone number, proof of purchase date, and a description of the defect. Wacom will pay for return shipping by United Parcel Service or by an equivalent service as chosen by Wacom.*

Wacom's sole obligation and entire liability under this warranty shall be, at Wacom's option, either the repair or replacement of the defective product or parts thereof of which Wacom is notified during the Warranty Period; provided, however, that you are responsible for (i) the cost of transportation of the product to the designated service location and (ii) any loss or damage to the product resulting from such transportation.



Wacom shall have no responsibility to repair or replace the product if the failure of the product has resulted from accident, abuse, misuse, negligence, or unauthorized modification or repair, or if it has been handled or stored other than in accordance with Wacom's storage instructions.

Any descriptions, drawings, specifications, samples, models, bulletins, or similar material, used in connection with the sale of the product, shall not be construed as an express warranty that the product will conform or comply with your requirements.

EXCEPT FOR THE LIMITED WARRANTY DESCRIBED ABOVE, THERE ARE NO OTHER WARRANTIES MADE BY WACOM ON THIS PRODUCT. NO ORAL OR WRITTEN INFORMATION OR ADVICE GIVEN BY WACOM, ITS DEALERS, DISTRIBUTORS, AGENTS, OR EMPLOYEES SHALL CREATE A WARRANTY OR IN ANY WAY INCREASE THE SCOPE OF THIS WARRANTY, AND YOU MAY NOT RELY ON ANY SUCH INFORMATION OR ADVICE. THIS WARRANTY GIVES YOU SPECIFIC LEGAL RIGHTS, AND YOU MAY ALSO HAVE OTHER RIGHTS WHICH VARY FROM STATE TO STATE.

WACOM LIMITS THE DURATION OF ANY LEGALLY IMPLIED WARRANTIES INCLUDING IMPLIED WARRANTIES OF MERCHANTABILITY OR FITNESS FOR A PARTICULAR PURPOSE, TO THE DURATION OF WACOM'S EXPRESS WARRANTY. SOME STATES DO NOT ALLOW LIMITATIONS ON HOW LONG AN IMPLIED WARRANTY LASTS, SO THE ABOVE LIMITATION MAY NOT APPLY TO YOU.

NEITHER WACOM NOR ANYONE ELSE WHO HAS BEEN INVOLVED IN THE CREATION, PRODUCTION, OR DELIVERY OF THIS PRODUCT SHALL BE LIABLE FOR ANY DIRECT, CONSEQUENTIAL, OR INCIDENTAL DAMAGES (INCLUDING DAMAGES FOR LOSS OF BUSINESS PROFITS, BUSINESS INTERRUPTION, LOSS OF BUSINESS INFORMATION AND THE LIKE) ARISING OUT OF THE USE OF OR INABILITY TO USE SUCH PRODUCT, EVEN IF WACOM HAS BEEN ADVISED OF THE POSSIBILITY OF SUCH DAMAGES. SOME STATES DO NOT ALLOW THE EXCLUSION OR LIMITATION OF INCIDENTAL OR CONSEQUENTIAL DAMAGES, SO THE ABOVE LIMITATION OR EXCLUSION MAY NOT APPLY TO YOU.

In the event that any of the above limitations are held unenforceable, Wacom's liability for any damages to you or any party shall not exceed the purchase price you paid, regardless of the form of any claim.

This Limited Warranty is governed by the laws of the United States of America and the state of Washington.

This Limited Warranty is valid for and only applies to products purchased and used inside the United States (and its territories or possessions) and Canada.

## WARRANTY SERVICE IN THE U.S.A. AND CANADA

To obtain Warranty service within the U.S. or Canada contact:

Wacom Customer Care Center

Phone: 1.360.896.9833

Email Inquiry form: <http://www.wacom.com/productsupport/email.cfm>

## WARRANTY ON SALES OUTSIDE OF THE U.S.A. AND CANADA

For products purchased or used outside of the United States and Canada, the warranty period is one (1) year from the date of original retail purchase. Upon discovery of a defect in the product, except in the Software, within the Warranty Period you should contact your local dealer or distributor. In all other respects the terms of the warranty as set forth above apply to such sales.

### Wacom Technical Support in Asia Pacific (except Japan and China)

Detailed Asia Pacific Limited Warranty policy and product registration may be found online at <http://www.wacom-asia.com>

To obtain technical support or Warranty service within Southeast Asia, Oceania and Taiwan, please contact the Wacom Customer Support Service.

Phone numbers can be found here: <http://www.wacom-asia.com/support/contact>

Should you have any questions about this Agreement, or if you desire to contact Wacom for any reason, please contact in writing:

#### In North and South America contact:

Wacom Technology Corporation  
1311 SE Cardinal Court  
Vancouver, Washington 98683  
U.S.A.

#### In Japan contact:

Wacom Co., Ltd.  
2-510-1 Toyonodai  
Otone-Machi, Kitasaitama-Gun  
Saitama, 349-1148  
Japan

#### In Asia Pacific contact:

Wacom Co., Ltd.  
Harmony Tower 18F, 1-32-2 Hon-Cho,  
Nakano-Ku, Tokyo 164-0012  
Japan

#### In Mainland China (Except Hong Kong) contact:

Wacom China Corporation  
Unit 2807, 28th Floor, Capital Tower,  
No 6 Jia, Jianguomenwai Avenue,  
Beijing, 100022, China  
E-mail: [support@wacom.com.cn](mailto:support@wacom.com.cn)

## LICENCE WARRANTY CONDITIONS (EUROPE, AFRICA AND MIDDLE EAST)

### SOFTWARE LICENCE AGREEMENT

#### Important customer information

The scope of delivery of this product covers copyright-protected computer programs ("software"), which are the inalienable intellectual property of WACOM Europe GmbH ("WACOM"). This software is an integral component of the product and is also held on the associated data carrier. The software of WACOM and the associated rights of use are not included with the purchase of this product from your retailer. WACOM grants you-the user-the right to use the software exclusively in accordance with the conditions stipulated in this licence agreement. By purchasing this product, you agree to the following licence conditions.

#### Conditions for using the software

WACOM issues the user with a personal, non-exclusive licence to use the software solely in connection with this product and for the correct operation of the product. This licence may only be assigned to a third party in connection with this product.

Use of this software includes the creation of permanent or temporary copies of the software by means of loading, displaying, exporting, transferring or saving, for the purposes of exporting the commands and the data they contain or for observing, researching or testing the software functions.

The customer may not license the software to a third party, lease, lend or in any other way provide access to the software. The customer may not copy, change, transfer or edit the software without prior written agreement from WACOM. The only exceptions to this are necessary procedures for creating a back-up copy and the scenarios outlined in section 2.

The customer may not carry out any "reverse engineering", decompile or depacketise the software, or try by any other means to discover the source code of the software. This restriction shall continue to apply after the termination of this agreement. If the software contains interfaces to other programs that are not supported by WACOM, WACOM shall provide the customer with the necessary information on request, as long as the customer can prove his right to use the software and agrees to bear the copying and postage costs.

WACOM AND ITS SUPPLIERS CANNOT OFFER ANY GUARANTEE FOR THE PERFORMANCE OF THE SOFTWARE OR FOR THE RESULTS PRODUCED THERE FROM. WACOM AND ITS SUPPLIERS OFFER NO GUARANTEES OR ASSURANCES (EITHER EXPRESSLY OR IMPLICITLY, INCLUDING THOSE THAT MAY BE DERIVED FROM A BUSINESS RELATIONSHIP OR FROM TRADE PRACTICE, OR FROM LEGAL PROVISIONS OR CUSTOMARY LAW) WITH REGARD TO THE MARKETABILITY, FREEDOM FROM DEFECTS OF TITLE OR USEFULNESS OF THE SOFTWARE.

WACOM AND ITS SUPPLIERS ACCEPT NO LIABILITY FOR DAMAGES, CLAIMS OR COSTS OF ANY KIND, NOR FOR CONSEQUENTIAL DAMAGES, SECONDARY, ACCIDENTAL, INDIRECT OR PENAL DAMAGES, PARTICULAR OR MISCELLANEOUS DAMAGES OR FOR DEMANDS OR INDEMNITY CLAIMS FOR REDUCED PROFITS OR LOSSES. THIS SHALL ALSO APPLY IN THE CASE OF A REPRESENTATIVE OF WACOM BEING PREVIOUSLY AWARE OF THE POSSIBILITY OF SUCH LOSSES, DAMAGES, CLAIMS OR COSTS, OR DEMANDS FROM THIRD PARTIES.



The existing limitations on liability shall not apply in the case of the assumption of explicit guarantees, or in case of fraudulent behaviour on the part of WACOM, nor for damages arising from wilful or grossly negligent behaviour on the part of WACOM, from damages leading to loss of life, personal injury or sickness or in the case of binding legal provisions. For slight negligence, WACOM and its suppliers shall only be liable in the event of a breach of essential contractual obligations. Liability when such an essential contractual obligation is breached is, however, limited to damages typical to this type of contract, which WACOM must have determined at the conclusion of the contract based on the known risks and circumstances at that time. Claims for reduced profits or expenses saved, indemnity claims from third parties or claims for any other direct or consequential damages still cannot be asserted in this case.

The laws of the Federal Republic of Germany shall apply to this agreement. However, the applicability of the United Nations Convention on Contracts for the International Sale of Goods is explicitly excluded. Krefeld is the sole place of jurisdiction for all claims arising from this contractual relationship and all disputes between the parties resulting from the formation, handling or termination of the contractual relationship, provided that the customer is a trader, a legal entity under public law or a special fund under public law.

The jurisdiction agreement shall also apply for customers who do not have a general place of jurisdiction in Germany. The jurisdiction agreement shall not apply if, due to legal provisions, a different sole place of jurisdiction must be established for the case. Furthermore, WACOM is authorised to file a lawsuit against the headquarters of the customer.

This licence constitutes the entire contractual agreement between the parties. It overrides all other verbal and written contracts and agreements and may only be altered by means of a written and signed contract. Should one of the provisions of these licence conditions be or become void, the validity of the other provisions shall not be affected, in full or in part. Should a provision be invalid, the legally permissible regulation most closely resembling the invalid regulation shall apply in its place.

## LIMITED WARRANTY

WACOM guarantees to you, as the initial purchaser, that the product hardware, when used as intended, will remain free from material defects and processing errors for a warranty period of TWO (2) YEARS and Cintiq products shall be guaranteed for a warranty period of THREE (3) YEARS, commencing from the purchase date and provided that the product was unused at the time of purchase. Defects in wear parts (e.g. pen tips) resulting from normal wear and tear are exempt from the warranty. Furthermore, WACOM guarantees that the data carriers delivered with the product are free from material defects and processing errors for a period of SIX (6) MONTHS from the date of purchase.

If the product-excluding any software-is discovered to be faulty it must be returned immediately to the place of purchase in its original packaging within the warranty period together with your name, address and telephone number, a description of the problem and a copy of the original receipt. The customer shall be liable for any possible damage or loss of the product during transit for this purpose. Under the provisions of this warranty, WACOM only undertakes to repair or replace the faulty product or parts at its own discretion, in cases where defects are proven and the product is sent within the warranty period.

WACOM is not obligated to repair or replace the product if: (a) the damage to the product results from any accident, misuse, improper use, negligence or unauthorised alteration or repair; (b) the product was not handled or stored according to the instructions provided by WACOM; (c) the damage resulted from normal wear and tear; or d) the serial number affixed by WACOM has been removed or rendered unintelligible.

If, when a claim made under this warranty is checked, it emerges that it is outside the permitted time period or is not covered by the warranty or that the product is not faulty, the costs of any checks or repairs must be borne by the customer.



Any descriptions, drawings, specifications, samples, models, notifications or similar material provided in connection with the purchase of the product cannot be taken as an explicit guarantee that the product corresponds to or fulfils the customer's requirements.

If this product is faulty, the purchaser shall be entitled to assert legal claims against the vendor for liability due to defects. These legal rights against the vendor are not limited by the existing warranty. The warranty grants the customer many additional rights under the conditions stipulated in this text.

This limited warranty shall apply if the registered office of the vendor is in the EU or in Iceland, Norway, Jersey, Switzerland, Russia, Ukraine, Croatia, Serbia, Tunisia, Turkey, Syria, Lebanon, Jordan, Israel, Egypt, United Arab Emirates, Iran or South Africa.

The granting of this limited warranty is subject to the laws of the Federal Republic of Germany. However, the applicability of the United Nations Convention on Contracts for the International Sale of Goods is explicitly excluded. Krefeld is the sole place of jurisdiction for all claims arising from this contractual relationship and all disputes between the parties resulting from the formation, handling or termination of the contractual relationship, provided that the customer is a trader, a legal entity under public law or a special fund under public law.

The jurisdiction agreement shall also apply for customers who do not have a general place of jurisdiction in Germany. The jurisdiction agreement shall not apply if, due to legal provisions, a different sole place of jurisdiction must be established for the case. Furthermore, WACOM is authorised to file a lawsuit against the headquarters of the customer.

Should one of the provisions of these limited warranty conditions be or become void, the validity of the other provisions shall not be affected, in full or in part. Should a provision be invalid, the legally permissible regulation most closely resembling the invalid regulation shall apply in its place.

If you have any questions about this agreement, or would like to contact WACOM for another reason, please contact us by post at this address:

WACOM Europe GmbH  
Europark Fichtenhain A9  
47807 Krefeld  
GERMANY





## GLOSSARY

**Active area.** The drawing area of the tablet where your Intuos4 tools are detected.

**Application-specific settings.** Intuos4 tool and tablet settings that have been customized for individual applications. The Wacom Tablet control panel enables you to customize a tool to behave uniquely in different applications. [Application-specific settings](#) are in effect whenever you use the application.

**Aspect.** The ratio between the vertical and horizontal dimension of the tablet or display.

**Click force.** The amount of force you must apply to the pen tip for a click to occur.

**Digital Ink.** A broad category that typically describes handwritten content which has been created using pen-based input on a computer. This handwritten content takes the form of sketches, ink mark-up, or handwriting. The handwriting can optionally be converted to typewritten text or simply left alone for use in its original format. Depending on your system and applications settings, the handwritten text you make with digital ink can be converted on-the-fly or at another time.

**Display Toggle.** An Intuos4 feature that allows you to work with your tablet on all displays or on one display at a time. Available only on multiple monitor systems. See [working with Display Toggle](#) for more information.

**Double-click assist.** A function of the Wacom Tablet control panel that makes it easier to double-click by setting the size of the double-click distance.

**Double-click distance.** The maximum distance (in screen pixels) that the cursor can move between clicks and still be accepted as a double-click. Increasing the double-click distance makes double-clicking easier, but may cause a delay in brush strokes in some graphics applications.

**Double-click speed.** The maximum time that can pass between clicks and still be accepted as a double-click.

**Eraser-aware application.** A software application that has built-in support for the Intuos4 eraser. These applications take advantage of the eraser in different ways, depending on what makes sense for the application.

**ExpressKeys.** The customizable control keys located on your professional pen tablet.

**ExpressKeys Left.** A tablet ORIENTATION setting where the Touch Ring and ExpressKeys are oriented to the left of the tablet.

**ExpressKeys Right.** A tablet ORIENTATION setting where the Touch Ring and ExpressKeys are oriented to the right of the tablet.

**Fingerwheel.** The control wheel on the Intuos4 Mouse and optional Airbrush.

**Journal.** A Microsoft Windows application that electronically simulates a physical journal pad, but with the advantages of digital note taking. For example, you can create quick sketches and jot handwritten notes that can be converted to text and sent on to colleagues for digital mark-up. Journal includes a variety of pen, marker, and highlighter tools, plus an eraser that is easily activated by the eraser of your Intuos4 pen. Additionally, your handwritten content is searchable within Journal.



**Mapping.** The relationship between your Intuos4 tool position on the tablet and the cursor position on the monitor screen.

**Modifier.** Modifier keys include SHIFT, ALT, and CTRL for Windows, or SHIFT, CONTROL, COMMAND, and OPTION for Macintosh. You can customize your Intuos4 tool to simulate a modifier key.

**Mouse acceleration.** A setting that allows you to adjust the screen cursor acceleration when your Intuos4 tool is in MOUSE MODE.

**Mouse mode.** A method for positioning the screen cursor. When you place an Intuos4 tool on the tablet, you can move the screen cursor with a “pick up and slide” motion similar to using a traditional mouse. This is known as relative positioning, and is the default setting for the Intuos4 Mouse or Lens Cursor. See also pen mode.

**Mouse speed.** A setting that allows you to adjust the speed at which your screen cursor moves when your Intuos4 tool is in MOUSE MODE.

**Nib.** The replaceable pen tip.

**OLED.** Organic Light Emitting Diodes (OLEDs) are made up of semi-conductor polymers. OLEDs do not need a background lighting to function, and thus have a lower power consumption and can be much thinner than LCD panels.

**Pen mode.** A method of positioning the screen cursor. Wherever you place your Intuos4 tool on the tablet, the screen cursor will jump to the corresponding point on the screen. This is known as absolute positioning, and is the default setting for all Intuos4 pen tools. Also, PEN MODE allows you to quickly position the screen cursor without having to first find it and then move it across the desktop. See also mouse mode.

**Pixel.** The smallest unit of measure on your monitor screen.

**Pressure sensitive.** A quality of the Intuos4 pen tip and eraser that senses the amount of pressure being applied. This is used to create natural-looking pen, brush, and eraser strokes in applications that are pressure sensitive.

**Pressure-sensitive application.** Any application that supports pressure-sensitive input.

**Proximity.** The height above the tablet’s [active area](#) where the Intuos4 tools are detected. See also [pointing](#).

**QuickPoint.** The QuickPoint options divide the tablet into two independent areas: a large area for drawing and a small area for quick navigation.

**Radial Menu.** A hierarchical menu (in radial format). Each level of the menu consists of eight menu slices which may contain various features and options to choose from. You can customize the buttons of your Intuos4 tools or tablet to display this menu.

**Screen cursor.** The pointer on the display screen. Screen cursors come in different shapes (such as an I-beam, arrow, or box), depending on which application you are running.

**Tablet PC Input Panel (TIP).** The Microsoft Windows Vista Tablet PC Input Panel enables you to use your Intuos4 pen to create handwritten notes or work with an on-screen keyboard. The Input Panel dynamically converts your handwriting to text. Information you create can then be inserted into other documents, spreadsheets, or illustrations. See [pen and digital ink capabilities in Windows Vista](#).





**Tilt sensitive.** A quality of the Intuos4 pen tip and eraser that senses the amount of tilt between the tool and tablet. This is used to create natural-looking pen, brush, and eraser strokes in applications that are tilt-sensitive.

**Tool ID.** A feature that makes each Intuos4 tool unique. If you are working with two identical pens, the tablet will recognize each one as a separate tool. This is particularly useful if you have customized each pen differently.

**Touch Ring.** The customizable control ring located on your professional pen tablet.

**USB.** Universal Serial Bus. A hardware interface standard for connecting computer peripheral devices. USB ports support hot-plugging, which allows you to connect or disconnect a USB device without turning off your computer.

**Wintab.** An interface standard used by Windows applications for receiving tablet information. Intuos4 supports all Wintab-compatible applications under Windows.



# INDEX

About the manual	5	ExpressKeys	34
Accessories and parts		mouse	31
available	86	buttons	32
ordering	85	fingerwheel	32
Active area, understanding	21	pen	27
Adding a new tool	50	Radial Menu	47
Airbrush		tablet	33
holding	74	ExpressKeys	34
replacing the tip	69	Touch Ring	35
using	74	tablet to screen mapping	36
applications, using integrated	73	tilt sensitivity	31
Application-specific settings	51	tip feel	28
changing	53	advanced	29
creating	52	tool buttons	30
removing	53	Touch Ring	35
Art Pen, using	74	Diagnostics	56
AutoCAD		Display Toggle, working with	48
calibrating for Intuos4	79	Double-click, customizing	28
configuring for Intuos4	77	Double-clicking, how to	14
configuring screen pointing areas	78	Dragging, with pen	14
configuring tablet menus	78	Drawing	
working with	77	with pressure sensitivity	16
Button functions	42	with tilt	16
Cable installation	20	Driver downloads, obtaining	67
Care, for tools and tablet	68	Environmental conditions	68
CE declaration	89	Eraser feel	
Clicking, how to	14	advanced	29
Control panel		customizing	29
features	25	Erasing	17
lists	26	ExpressKeys	
opening	24	customizing	34
settings	26	display optimization	73
tabs	26	testing	58
Customizing		using	22
double-click	28	Eye-hand coordination exercise	17
eraser feel	29	FCC notice	88
advanced	29		



Features			
control panel	25	double-clicking with	14
input tools	10	dragging with	14
tablet	8	drawing	
Fingerwheel, mouse, using	18	with pressure sensitivity	16
Force proportions	39	with tilt	16
Functions, button	42	erasing with	17
General problems, troubleshooting	60	holding	12
Holding		pointing with	13
Airbrush	74	replacing the tip	69
pen	12	side switch	15
Industry Canada notice	88	testing	57
Information, product	85	using	12
Input tools, features	10	Pen Mode	36
Installing multiple tablets	71	Pen tip, replacing	69
Lens cursor	75	Pointing, with pen	13
customizing	76	Preferences, managing tablet	70
testing	76	Pressure sensitivity, drawing with	16
Macintosh-specific problems, troubleshooting	64	Product information	85
Mapping to multiple monitors	41	Proximity	13
Mouse		Radial Menu	
buttons, customizing	32	customizing	47
customizing	31	using	47
fingerwheel		Removing application-specific settings	53
customizing	32	Screen area	38
using	18	Settings	
testing	59	changing application specific	53
using	18	control panel	26
Mouse Mode	37	creating application specific	52
Multiple		removing application specific	53
monitors, mapping to	41	Side switch, using	15
tablets, installing	71	Software	
New tool, adding	50	driver downloads	67
Nib, replacing	69	uninstalling	70
Ordering parts and accessories	85	Specifications, product	
Orientation, tablet	38	Airbrush	83
physical configuration	20	Art Pen	84
Parts and accessories		Classic Pen	84
available	86	general	82
ordering	85	Grip Pen	83
Pen		Inking Pen	84
clicking with	14	Intuos4 L tablet	83
customizing	27	Intuos4 M tablet	82
		Intuos4 S tablet	82





Intuos4 XL tablet	83	Tip feel	
lens cursor	84	advanced	29
mouse	83	customizing	28
Tablet		Tool buttons, customizing	30
area	40	Tools	
customizing	33	testing	56
ExpressKeys		working with multiple	50
customizing	34	Touch Ring	
testing	58	customizing	35
using	22	testing	58
features	8	using	23
mode, changing	71	Troubleshooting	
orientation	38	general problems	60
physical configuration	20	Macintosh-specific problems	64
preferences, managing	70	tables	60
storing	68	Windows-specific problems	63
testing	55	Uninstalling software	70
Touch Ring		USB, cable installation	20
customizing	35	Using	
testing	58	Airbrush	74
using	23	applications integrated for tablet control	73
working with	19	Art Pen	74
Tablet to screen mapping, customizing	36	ExpressKeys	22
Technical Support, contacting	66	mouse	18
Testing		pen	12
ExpressKeys	58	Radial Menu	47
mouse	59	Touch Ring	23
pen	57	Wacom international offices	103
tablets	55	Windows-specific problems, troubleshooting	63
tools	56	Work area, setting up	11
Touch Ring	58		
Tilt			
drawing with	16		
sensitivity, customizing	31		





## WACOM INTERNATIONAL OFFICES

### Wacom Technology Corporation

1311 SE Cardinal Court  
Vancouver, WA 98683  
U.S.A.

Telephone: +1.360.896.9833

Fax: +1.360.896.9724

### Wacom Co., Ltd.

#### **Japan Marketing and Sales Division**

Harmony Tower 21F, 1-32-2 Hon-Cho,  
Nakano-Ku, Tokyo 164-0012  
Japan

Internet: <http://tablet.wacom.co.jp>

### Wacom China Corporation

Unit 2807, 28th Floor, SK Tower  
No 6 Jia, Jianguomenwai Avenue,  
Beijing, 100022, China

Internet: <http://www.wacom.com.cn>

### Wacom Australia Pty. Ltd.

Unit 8, Stage 1 Cumberland Green  
2-8 South Street Rydalmere  
NSW 2116 Australia

Telephone: +61.2.9422.6700

Fax: +61.2.9420.2272

### Wacom Taiwan Information Co., Ltd.

Suite 605, 6th floor, No. 205 Tun-Hwa North Road  
Taipei, 105 Taiwan

Telephone: +886.2.2712.2675

Fax: +886.2.2712.9789

### Wacom Europe GmbH

Europark Fichtenhain A9  
47807 Krefeld  
Germany

Telephone: +49.(0)2151.3614.0

Fax: +49.(0)2151.3614.111

### Wacom Co., Ltd.

#### **Asia Pacific Marketing and Sales Division**

Harmony Tower 18F, 1-32-2 Hon Cho,  
Nakano-Ku, Tokyo 164-0012  
Japan

Telephone: +81.3.5309.1513

Fax: +81.3.5309.1514

### Wacom Korea Co., Ltd.

25th Floor DMC iaan Sangam 2nd Complex, 1653  
Sangam-dong, Mapo-gu, Seoul, Korea, 121-270  
Korea

Telephone: +82.2.557.3894

Fax: +82.2.557.3895

### Wacom Singapore Pte. Ltd.

3 Bishan Place  
CPF Bishan Building #06-08  
Singapore 579838

Telephone: +65.6258.8640

Fax: +65.6258.8697

