



Cintiq[®] 24HD

interactive pen display



User's manual

Cintiq 24HD touch (DTH-2400)

Cintiq 24HD (DTK-2400)

Setting up

Using the display stand

Using the pen

Customizing the pen

Navigating with multi-touch

Customizing multi-touch

Using the pen display

Customizing the pen display

Using the Radial Menu

Application-specific settings

FAQs

Troubleshooting

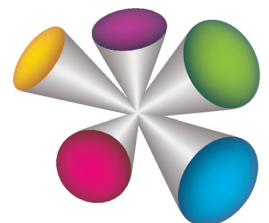



Cintiq 24HD

User's Manual

Version 2.0, Rev C1412

Copyright © Wacom Co., Ltd., 2012

All rights reserved. No part of this manual may be reproduced except for your express personal use.

Wacom reserves the right to revise this publication without obligation to provide notification of such changes.

Wacom does its best to provide current and accurate information in this manual. However, Wacom reserves the right to change any specifications and product configurations at its discretion, without prior notice and without obligation to include such changes in this manual.

The above year indicates when this manual was prepared. However, the date of release to the users of the "manual" is simultaneous with the introduction into the market of the applicable Wacom product.

Cintiq and Wacom are registered trademarks of Wacom Co., Ltd.

Adobe and Photoshop are either registered trademarks or trademarks of Adobe Systems Incorporated in the United States and/or other countries. Microsoft, Windows, and Vista are either registered trademarks or trademarks of Microsoft Corporation in the United States and/or other countries. Apple, the Apple logo, and Mac are trademarks of Apple, Inc., registered in the U.S. and other countries.

Any additional company and product names mentioned in this documentation may be trademarked and/or registered as trademarks. Mention of third-party products is for informational purposes only and constitutes neither an endorsement nor a recommendation. Wacom assumes no responsibility with regard to the performance or use of these products.

ExpressKey is a registered trademark of Ginsan Industries, Inc., and is used with permission.





TABLE OF CONTENTS

About the manual	5	Pen display controls	39
UNPACKING YOUR CINTIQ	6	Using the hardware control buttons	41
Unpacking your product	6	Using the ExpressKeys	42
Box contents	8	Using the Touch Rings	44
SETTING UP YOUR CINTIQ	10	Working with multiple monitors	45
System requirements	10	Adjusting the display	46
Step 1: Hardware installation	11	Factory presets, auto-sync, and user settings	46
Step 2: Software installation	14	On Screen Display (OSD) settings	47
GETTING TO KNOW YOUR CINTIQ	15	OSD controls, Cintiq 24HD touch	48
Pen display features	15	Brightness/Contrast controls	48
Front view, Cintiq 24HD touch	16	Auto Adjust (analog input only)	49
Rear view	17	Image controls	49
Front view, Cintiq 24HD	18	Color control systems	51
Pen features	19	Tools	52
USING THE CINTIQ DISPLAY STAND	20	Menu tools	53
Display stand features	21	ECO Information	54
Display stand location	22	Information	55
Adjusting display height and incline	25	OSD Warning	55
Using a keyboard with Cintiq	27	Using the Picture Mode function	55
Cable replacement	28	Advanced OSD	57
WORKING WITH YOUR CINTIQ	31	OSD controls, Cintiq 24HD	67
Setting up your work area	32	Power saving	69
Configuring Cintiq for handedness	33	THE MULTI-TOUCH EXPERIENCE WITH CINTIQ	70
Using the Grip Pen	34	Navigating with multi-touch	71
Holding the pen	35	Customizing multi-touch	79
Positioning	36	Setting multi-touch options	80
Clicking	36	Choosing standard multi-touch functions	81
Dragging	37	Choosing custom multi-touch functions	82
Using the side switch	37	Disabling multi-touch	83
Working with pressure sensitivity	37	Testing multi-touch	84
Drawing with tilt	38	CUSTOMIZING YOUR CINTIQ	85
Erasing	38	Manage your control panel settings	86
		Control panel overview	87
		Calibrating the pen display	89





Customizing the pen	90	Pen tablet troubleshooting	121
Adjusting tip feel and double-click	91	General problems	121
Adjusting eraser feel	92	Pen problems	123
Advanced tip and eraser pressure settings	92	Multi-touch problems	126
Customizing tool buttons	93	Windows-specific problems	127
Customizing tilt sensitivity	94	Mac-specific problems	128
Customizing pen display functions	94	Technical support options	130
Customizing the ExpressKeys	95	Obtaining software updates	131
Customizing the Touch Rings	96	FREQUENTLY ASKED QUESTIONS	132
Button functions	97	CARE AND MAINTENANCE	134
Using and customizing the Radial Menu	104	Caring for Cintiq	134
Working with Display Toggle	105	Replacing the pen nib	135
Application-specific settings	106	OTHER USEFUL INFORMATION	137
Creating an application-specific setting	107	Removing Cintiq from the display stand	138
Changing application-specific settings	108	Mounting Cintiq on the display stand	141
Removing application-specific settings	108	Using an alternate mount or stand	144
Working with multiple tools	109	Uninstalling Cintiq	145
Renaming the tablet in the tablet list	110	Managing preferences	146
TROUBLESHOOTING	111	Installing multiple tablets	147
Testing Cintiq	112	Using applications integrated for tablet control	148
Testing controls and input tools	114	Importing expert settings	149
Testing the hardware control buttons	115	Pen and digital ink capabilities in Windows	150
Testing the ExpressKeys	115	Product information	151
Testing the Touch Rings	115	Ordering parts and accessories	152
Testing a pen	116	Available parts and accessories	152
Display troubleshooting	117	GLOSSARY	153
General display problems	117	INDEX	156
VGA problems	120		





ABOUT THE MANUAL

This manual provides quick access to information about your Cintiq 24HD or Cintiq 24HD touch.

The information is common to Windows and Mac computers. Windows screen captures are shown unless otherwise noted.

- Go directly to [table of contents](#) or [index](#) topics by clicking on them.
- Use the navigation controls to move through the manual.

			Go to front page.
Contents	Go to table of contents.		Page back, or page forward.
Index	Go to index.		Go back to previous view.
topic	Go to topic.		Topic continued.

- Use your .pdf viewer zoom-in tool to increase the size of the manual on your display screen. See the viewer application help for information on any additional tools that help you use and print the manual.
- SMALL CAPITAL LETTERS are used to identify the names of keyboard keys, dialog boxes, and control panel options.
- Be sure to see also the Important Product Information guide for Cintiq, located on the Installation CD. The guide includes product safety precautions, specifications, and your license agreement.
- The following information is not included with this product: information about your specific computer hardware or operating system, or information about your application software. Your best source for this information is the set of manuals and discs that came with your hardware, operating system, or application.

Wacom's philosophy is to continually improve all of its products. As a result, engineering changes and improvements are made from time to time. Therefore, some changes, modifications, and improvements may not be covered in this manual.



UNPACKING YOUR CINTIQ

Your Cintiq 24HD interactive pen display comes pre-assembled with the pen display mounted on the Cintiq display stand. The product parts and accessories are packed together in the accessories box. To avoid damage, see the instructions on the following pages before setting up and using Cintiq.

[Unpacking your product](#)

[Box contents](#)

UNPACKING YOUR PRODUCT

Carefully unpack and place all items on a stable surface.

1. Open the box cover.

- Remove the plastic joiners from the lower corners of the product box. Then lift away the upper portion of the box.
- Fold open the lower side flaps.
- Remove the accessory parts box.
- Move the cabling to the side of the box and lift away the cabling enclosure.
- Remove the side packing blocks and any other packing materials from around the interactive pen display and stand.

2. Lock the display in place.

- Fully raise the display and support arms to a vertical position where they will lock in place.
- Locate the incline levers on each side of the unit. Grasp the pen display on both sides at approximately the same height as the levers.
- Use your fingertips to gently squeeze the upper levers. As you squeeze, gently rotate the display to a flat position.

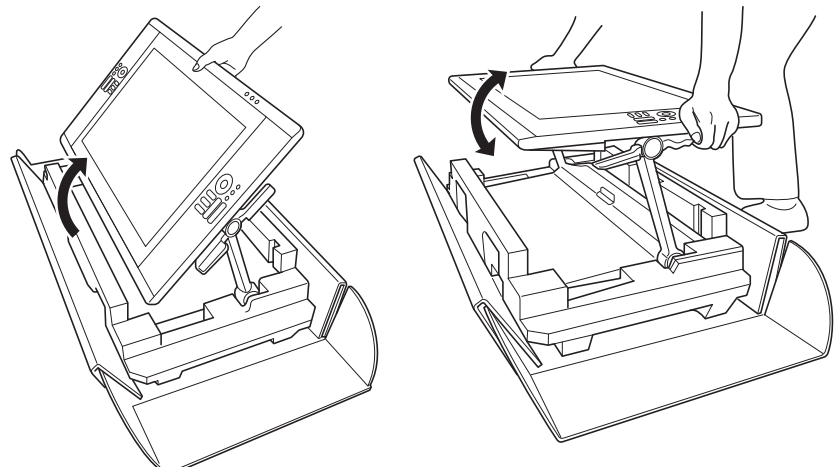

3. Carefully remove Cintiq from the box. Holding the lower part of the display support arms near the display stand base, lift and move this product while also supporting the base of the stand.

Important: Do not attempt to lift Cintiq by yourself. Each person should use both hands to securely grasp the product. The assembly is heavy. Work together, and lift carefully.

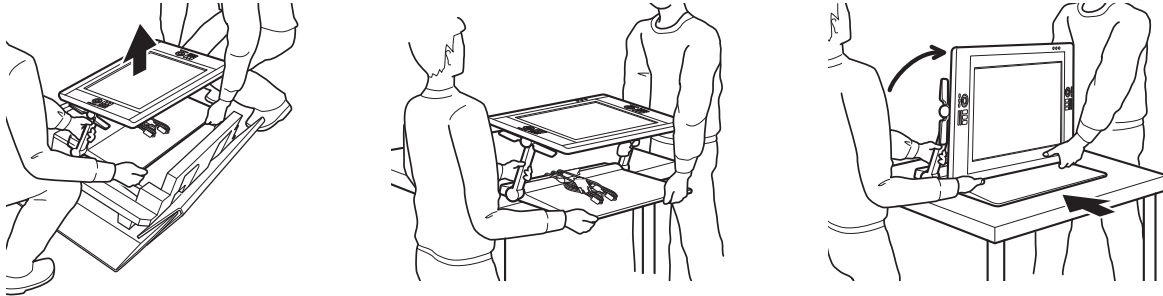

Warning

Request assistance from another person or persons when removing, lifting, or moving this product. Physical damage or personal injury may result from a single person attempting to lift or carry this product.

Use care not to let the pen display fall backward. Doing so may cause personal injury or damage to your product. Request assistance from another person if needed.

Avoid catching your finger in the gaps of the movable portions of the stand.

Locate the cables on top of the stand base, and ensure they do not hang free. Tripping over loose cables can cause physical damage or personal injury.

Do not lift by the incline levers or upper portion of the support arms. Improper operation may lead to physical injury or damage to the stand. Avoid catching your finger in the gaps of the movable portions of the stand.

Place your product completely and securely on a level, stable surface. Do not allow any portion of the display stand base to protrude from the installation surface. Otherwise, Cintiq may fall and cause physical damage or personal injury.

4. Place the Cintiq assembly in a stable position on your desktop or other work surface so that it will not tip or fall. See [display stand location](#).
5. When in place, use the incline levers to rotate the display back to a vertical position.
6. Inventory your [box contents](#).

BOX CONTENTS

After [unpacking your product](#), ensure the box contents are complete.

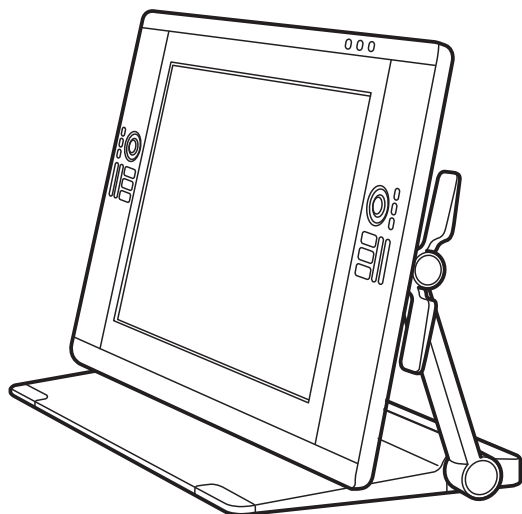

Cintiq 24HD interactive pen display & Cintiq display stand, pre-assembled

(DVI-D, DisplayPort, and USB cables are pre-installed. DisplayPort cable is stored within the Cintiq display stand.)

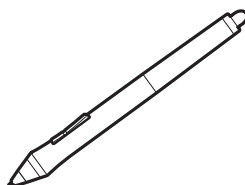

Pen, with personalization rings
To personalize your pen, unscrew the tip cone and replace the ring with a different color.

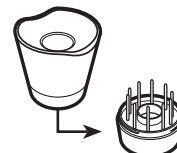

Pen stand

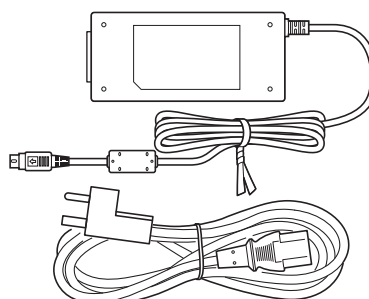

AC power adapter and cable



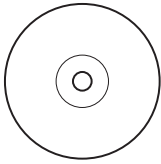

Installation CD
Includes the software driver and
Important Product Information guide.

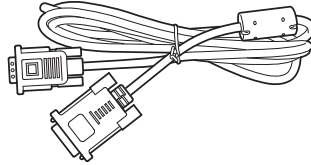

DVI-I to VGA cable

(DVI-D, DisplayPort, and USB cables
are pre-installed. DisplayPort cable is
stored within the Cintiq display stand.)



Spacers, qty 3, for VESA mount



Screws, qty 6, for VESA mount

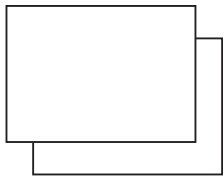

Quick Start Guide
and
Warranty

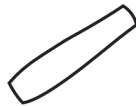

Pen grip, wide bodied
May not be included in some product configurations.

Notes:

Some configurations may include additional CDs or DVDs containing application software. To install, see the instructions for those CDs or DVDs.

Save the packing materials and package box for use when shipping or storing Cintiq.

When packing Cintiq for transport, adjust incline to a flat position. Always pack Cintiq in the original containers and protective cushions.

Before installing, take some time to learn about your [Cintiq interactive pen display](#) and [Cintiq display stand](#).



SETTING UP YOUR CINTIQ

Your Cintiq 24HD interactive pen display functions as both a display and a pen tablet. Follow the instructions below to complete the hardware and software installation.

[System requirements](#)

[Step 1: Hardware installation](#)

[Step 2: Software installation](#)

SYSTEM REQUIREMENTS

Make sure your computer meets the following minimum system requirements:

- **PC.**
 - Cintiq 24HD touch: Windows 7 or later. 32 or 64-bit configurations. DVI, DisplayPort, or VGA port. Available USB port and CD-ROM drive.
 - Cintiq 24HD: Windows 7, Vista (SP2 or later), XP (SP3 or later). 32 or 64-bit configurations. DVI, DisplayPort, or VGA port. Available USB port and CD-ROM drive.
- **Mac.** OS X, v10.5.8 or later. Intel-based platforms only are supported. DVI, DisplayPort, or VGA port, or appropriate Mini DisplayPort to DVI adapter. Available USB port and CD-ROM drive.

Cintiq supports digital (DVI or DisplayPort) and analog (VGA) video signals. For optimum performance, connect Cintiq to a digital video card. VGA connection is not recommended as the display quality will not be as good as with a digital connection.

Notes:

You may be able to set up Cintiq as a mirrored, extended, or independent display. When working with more than one monitor, Cintiq will map to the monitors based upon how your system is configured. By default, if you are in mirror mode, the pen display will map to the entire space on each monitor. See your hardware and operating system documentation for details on configuring your system for use with multiple monitors.

A [Display Toggle](#) function is available for use with multiple display systems. This enables you to toggle the screen cursor between Cintiq and your other displays.

STEP 1: HARDWARE INSTALLATION

In this step, install the video, USB, and power cables.

Important: Never connect or disconnect the video or power cables while your computer or pen display are powered on. This can damage the display or video card.

1. Turn off your computer.
2. Determine if your computer has a digital (DVI or DisplayPort) or analog (VGA) port. If your computer has only one video port, unplug your previous monitor or add a second video card. For best results, connect Cintiq to a DVI-D or DisplayPort card.
3. Follow the below instructions for your video port. Make sure to tighten any connector thumbscrews. See – A – in the [connection diagram](#).

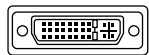

DVI-I

For DVI operation, use the DVI-D video cable connector located at the base of the Cintiq display stand. Connect the cable to the DVI port located on your computer video card.

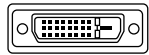

DVI-D

Cintiq can be connected to either a DVI-D or a DVI-I card.

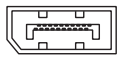

DisplayPort

For DisplayPort operation, use the DisplayPort cable. The cable is located within the base of the display stand. Access the DisplayPort cable by removing the rear cover from the display stand. See [cable replacement](#) for details.

Connect the DisplayPort cable to your computer video card.

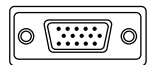

VGA

For VGA operation, you will need to completely remove the DVI-D cable and replace it with the provided DVI-I to VGA cable. See [cable replacement](#) for details.

If connecting to a Mac Mini DisplayPort, you will need to obtain an appropriate DVI adapter cable, such as those offered by Kanex, Apple, or other manufacturers. Check with your local product retailer or an online outlet for availability.

Connect the adapter between the Cintiq DVI-D cable connector and your Mac.

4. Using the USB cable located at the base of the Cintiq display stand, connect to an available USB port on your computer or USB hub attached to your computer. See – B – in the [connection diagram](#).
5. Connect the power adapter to the display stand extension cable for power. See – C – in the [connection diagram](#).
6. Connect the adapter power cable and plug into an AC outlet. See – D – in the [connection diagram](#).
7. Turn on the pen display. The power LED will glow orange.





Cintiq cabling diagram

Connection cables are pre-installed.

- **DVI-D.** Connector located at display stand base.
- **DisplayPort.** Remove cover to access cable. See [cable replacement](#).
- **VGA.** Requires removal of DVI-D cable and replacement with the provided DVI-I to VGA cable. See [cable replacement](#).
- **USB.** Connector located at display stand base.

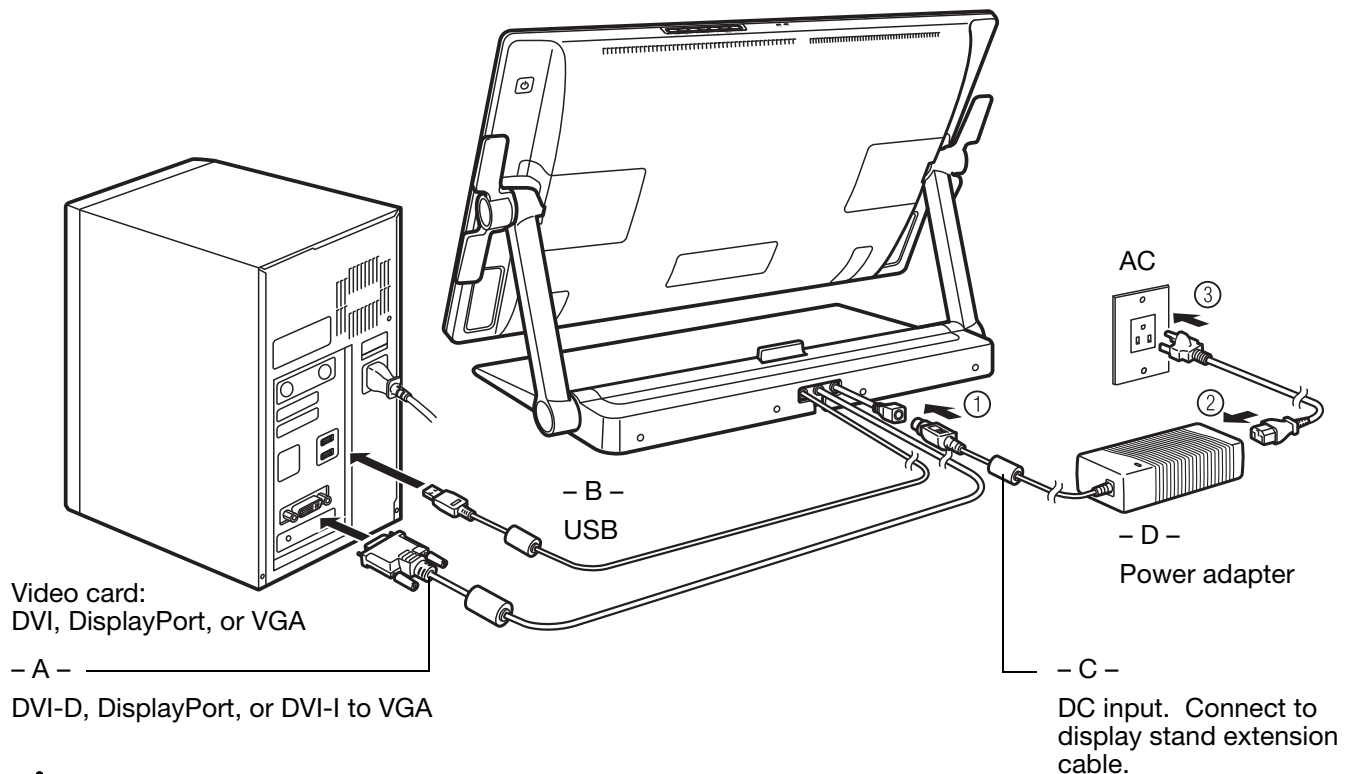

⚠ Caution

Do not connect or disconnect the video or power cables while Cintiq or your computer are turned on. This can damage the display or computer video card.

Only use a power adapter specified for use with your pen display. Use of an improper power adapter may damage the pen display.

For optimum performance, the display refresh rate should use a vertical frequency of 60 Hz. Make sure the refresh rate does not exceed the maximum vertical frequency (85 Hz) that Cintiq can support. See the Important Product Information guide for specifications.



8. Turn on your computer. The interactive pen display will automatically install as a default monitor.
9. As necessary, configure the display control panel settings for the proper size and color resolution. For best results, set Cintiq to the maximum (native) resolution of 1920x1200. See the Important Product Information guide located on the Installation CD for details about resolution sizes that can be used with Cintiq. The display size and color resolution may be constrained by the capabilities of your video card. To fine-tune, see [adjusting the display](#).

Windows: If you are using Cintiq as a secondary display, you may first need to enable Cintiq in your display properties control panel.

After the LCD monitor portion of the installation is working to your satisfaction, move on to [step 2: software installation](#).

Notes:

Each LCD panel is produced under very stringent quality standards. Production techniques cannot guarantee an absolutely perfect display. Wacom does not allow any pixel to be always white. A small number of subpixels are allowed to show a wrong color for some parts of the color spectrum. See the Important Product Information guide for more information.

If an image has fine striping (such as screen stripes), it may appear to flicker or display a moiré pattern.

Do not apply excessive pressure on the display screen surface, it may cause the appearance of a moiré or pooling pattern. If this occurs, use less pressure on the display screen when working with the pen.

When a still image is displayed for a long period of time, an after-image may remain for a short time. To prevent this, use a screen saver or other power management feature.

To extend the life of the pen display backlight, set your computer's power management to turn off the display when not in use for extended periods of time.

Your eyes may feel more comfortable if you reduce the display screen brightness when working with Cintiq for extended periods of time. This will also extend the life of the backlight and reduce the heat felt on the display screen surface.

Some models may include a color profile on the Installation CD. To activate for use with Cintiq, first identify Cintiq as a pen display in the system display settings control panel. Then select the Cintiq profile in the color management control panel. For details, see the color management information in your operating system and application documentation.

For troubleshooting tips, see [troubleshooting](#).

STEP 2: SOFTWARE INSTALLATION

Save your work and close all open applications. Temporarily disable any virus protection programs.

1. Insert the Installation CD into your computer's CD-ROM drive. If the software installer menu does not automatically display, double-click on the INSTALL icon located on the CD. (When available, you can also download and install the latest software driver from the Wacom web site for your region.)
2. Click INSTALL TABLET and follow the prompts to install the driver software.
3. Reactivate your virus protection program.
4. After completing the software installation, make sure you can use your pen on the Cintiq display screen to move the screen cursor.

When you place the pen tip on the display screen, the screen cursor should immediately jump to a corresponding position approximately beneath the pen tip. Lift the pen tip and place it on the display screen surface in a different location. The screen cursor should again jump to the new position. This is known as absolute positioning, and enables you to position the screen cursor without having to drag your pen across the display screen surface. If your product model supports multi-touch, the screen cursor will immediately jump to a position beneath your finger tip when you touch the display screen surface.

5. Check the Read Me file for updated information. Review also the Important Product Information guide located on the Installation CD for cautions and warnings. If you have trouble installing Cintiq, see [troubleshooting](#).
6. Next, precisely align the screen cursor with the pen tip position. See [calibrating the pen display](#).

Notes:

User-specific preferences are supported. After logging on, each user can customize their personal settings in the Wacom Tablet control panel. Switching to another user (either by logging on or fast user switching methods) will automatically load the settings for that user.

If the pen display does not respond properly or you lose cursor control, the pen display preferences may be corrupted. See [managing preferences](#) to delete the current preference settings and return the pen display to its factory default condition.

Driver installation automatically activates the pen input functions available within Microsoft Windows 7, Vista, and Office 2007 or later (except for Windows 7 Starter and Home Basic, and Windows Vista Home Basic). See [pen and digital ink capabilities in Windows](#).

The Cintiq 24HD touch does not support operation on Windows Vista or XP systems.

To download a new software driver (when available) from the Internet, see [obtaining software updates](#).

To uninstall the software driver, see [uninstalling Cintiq](#).

GETTING TO KNOW YOUR CINTIQ

The Cintiq 24HD interactive pen display combines the benefits of a Liquid Crystal Display (LCD) with the control, comfort, and productivity of Wacom's cordless, battery-free pen technology. This gives you a direct pen-on-screen interface for your computer. Cintiq 24HD touch also supports multi-touch.

The basic components of your Cintiq include a Wacom pen tablet internally mounted behind a high quality IPS color display, the Wacom Grip Pen, and the [Cintiq display stand](#).

This manual describes how to [set up](#) and [use](#) your Cintiq. The Wacom Tablet control panel enables you to customize your pen and pen display settings. To learn more, see [customizing](#).

[Pen display features](#)

[Pen features](#)

PEN DISPLAY FEATURES

Take some time to familiarize yourself with the features and components of your Cintiq interactive pen display. Although they will appear as separate devices to your operating system, the display and tablet sensor function as an integrated output and input device. The tablet sensor reports pen coordinates, pressure, tilt, switch, eraser, and other information. If your product model also supports multi-touch, a touch sensor reports the appropriate information related to your touch actions or gestures.

- Many applications have built-in support for pen display features (such as pressure sensitivity, tilt, and rotation). Visit the Wacom web site to learn about applications that support these features. See [product information](#).
- For information on how best to use pen display features within a specific application, see the instructions in that application's manuals.

Each product model within the Cintiq family has a specific feature set. Not all models or accessories are available in all regions.

PEN DISPLAY MODEL	MULTI-TOUCH	PEN INPUT	EXPRESSKEYS	TOUCH RINGS
Cintiq 24HD touch	X	X	X	X
Cintiq 24HD		X	X	X

You will find that icons are located near some of the topic headings in this manual. Use them to quickly identify sections that have information specific to multi-touch or pen input. Icons will not be used in sections that commonly apply to all Cintiq models. Model-specific notes may be used as necessary.

- Multi-touch is identified by this icon: 

- Pen input is identified by this icon: 

FRONT VIEW, CINTIQ 24HD TOUCH



Status LED

- When using pen in active area of the pen display, lights blue when the pen tip, eraser, or side switch are pressed. Learn about [using the Grip Pen](#).
- Lights when you touch the pen display screen. Learn about the [multi-touch experience](#) with Cintiq.
- LED will not light unless the USB cable is plugged into an active USB port and a video signal is present.

Power LED

- Lights blue when power has been supplied to Cintiq and a video signal is present.
- Glows orange when no video signal is detected. (e.g., The computer is turned off, starting up, or has entered a power management mode in which video signals are not sent.)

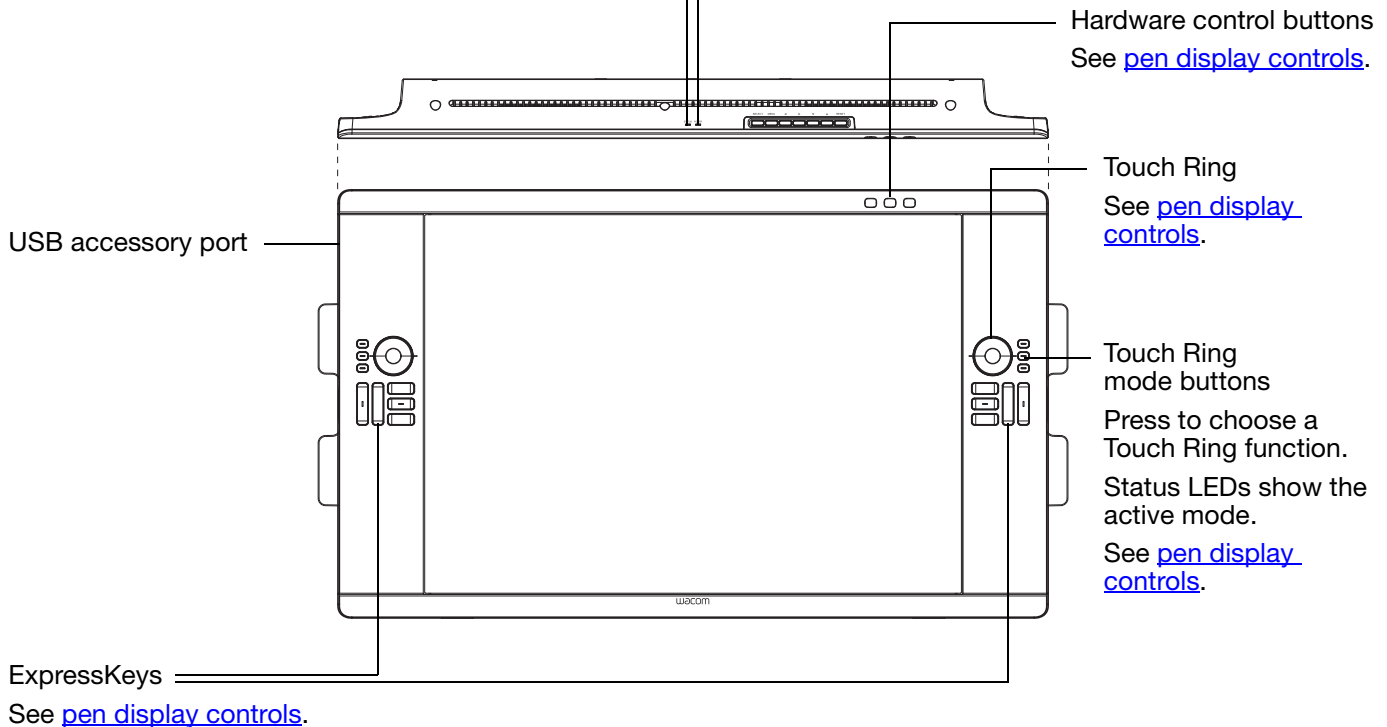

See also [rear view](#).

REAR VIEW

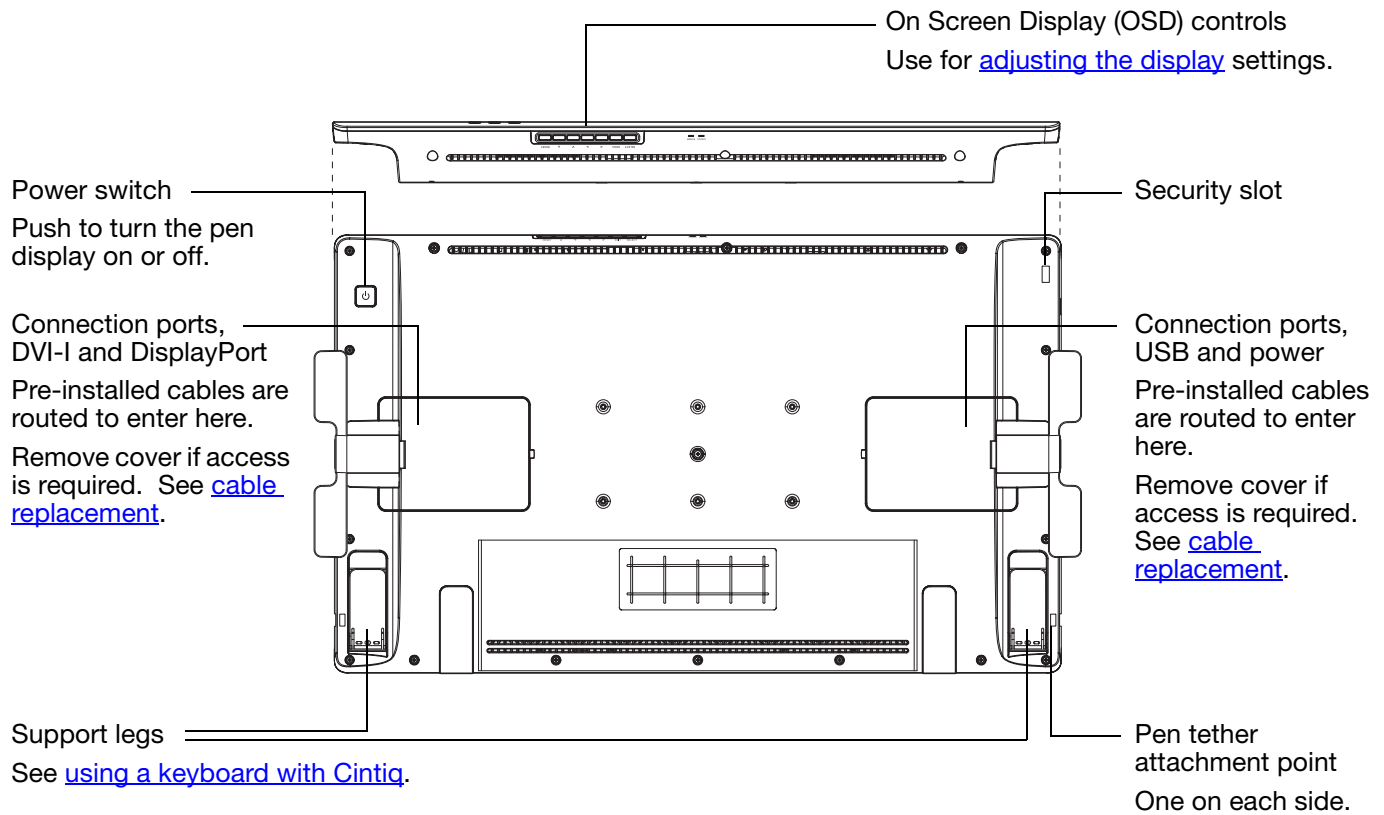

See also front view, [Cintiq 24HD touch](#) or [Cintiq 24HD](#).

Next steps:

- Review the [pen features](#) and learn about the [Cintiq display stand](#).
- If your product model supports multi-touch, learn about the [multi-touch experience](#) with Cintiq.
- Then, if you have not already done so, move on to [setting up your Cintiq](#).

FRONT VIEW, CINTIQ 24HD



Status LED

- When using pen in active area of the pen display, lights blue when the pen tip, eraser, or side switch are pressed.
- LED will not light unless the USB cable is plugged into an active USB port and a video signal is present.

Power LED

- Lights blue when power has been supplied to Cintiq and a video signal is present.
- Glows orange when no video signal is detected. (e.g., The computer is turned off, starting up, or has entered a power management mode in which video signals are not sent.)

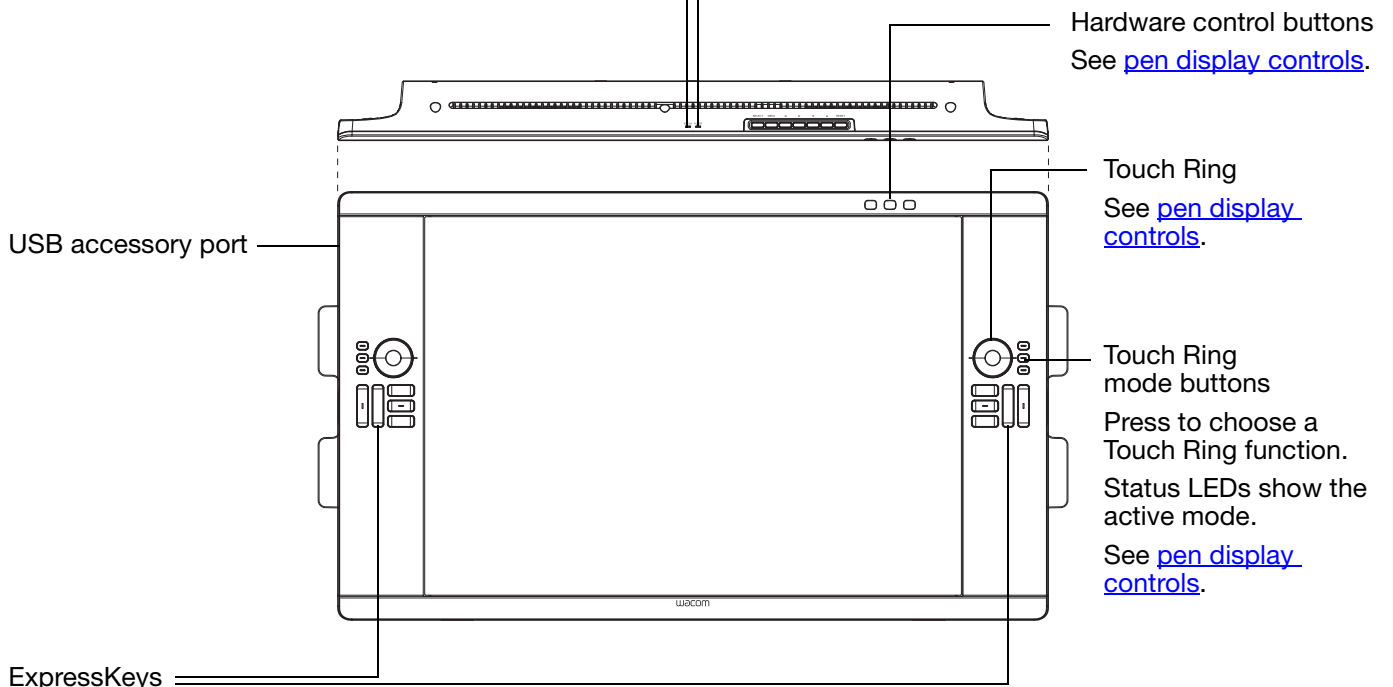

Hardware control buttons
See [pen display controls](#).

Touch Ring
See [pen display controls](#).

Touch Ring mode buttons
Press to choose a Touch Ring function.
Status LEDs show the active mode.
See [pen display controls](#).

ExpressKeys
See [pen display controls](#).

See also [rear view](#).

PEN FEATURES



Eraser: When brought within proximity of the pen display screen, the tablet portion of the display reports the pen location. Pressure information is reported as you press down on the eraser. By default, the function is set to ERASE.

Side switch: Be sure the customizable side switch is in a convenient location where you can toggle it with your thumb or forefinger but not accidentally press it while using the pen.

You can use the switch whenever the pen tip is within proximity of the display screen. You do not need to touch the pen tip to the display surface.

Toggle the switch in either direction to activate the button functions. By default, the upper switch is set to DOUBLE CLICK and the lower switch is set to RIGHT CLICK.

Pen tip (replaceable nib): The pen activates as soon as it is brought within proximity of the pen display screen. This allows you to position the screen cursor without touching the pen tip to the display screen.

When pressure is applied to the pen tip, the pen simulates a primary mouse button click. Tip click pressure can be adjusted in the Wacom Tablet control panel.

Tips:

- The pen enters proximity when the tip or eraser is brought within 5 mm (0.2 inch) of the pen display screen surface.
- To resume operations after the pen display has entered auto sleep mode, bring the pen tip within proximity or touch the pen tip on the pen display screen.

Important:

- Use only the pen that came with your product, or a Wacom accessory pen specified for use with Cintiq. Other pens may not function properly. See [available parts and accessories](#). Also, the Cintiq pen tip is specifically designed for use with the Cintiq pen display. The tips on other pens could damage the Cintiq display screen.
- When not in use, place the pen in the pen stand or lay it flat on your desk. To maintain the sensitivity of your pen, do not store it in a container where it will rest on the tip or eraser. Improper storage may damage pen tip pressure sensor(s).

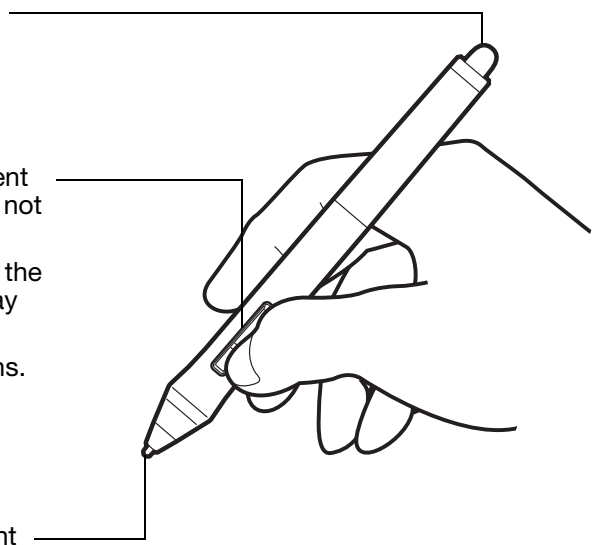

USING THE CINTIQ DISPLAY STAND

The Cintiq display stand is designed to support the weight of your Cintiq interactive pen display.

- Cintiq can accommodate a variety of uses and working styles. Use the stand to adjust the working position of Cintiq so as to best meet your needs throughout the day.
- You can move or slide Cintiq to different locations on your desktop. Remember that you may need to adjust the height or incline to which you have positioned Cintiq before moving the unit.

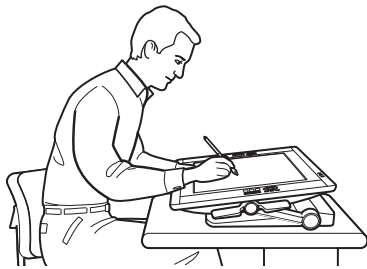

Adjust the display position as needed to emulate an easel, animator's table, or drafting table.

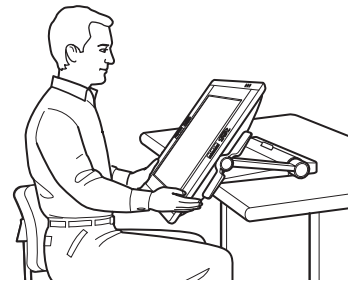

For a more immersive experience, position the display to [overhang your desktop](#).



Adjust Cintiq to a more vertical position when a large amount of keyboard input is required. This position is also useful when presenting your work to co-workers or clients. Extend the pen display support legs to [place a keyboard beneath the pen display](#).

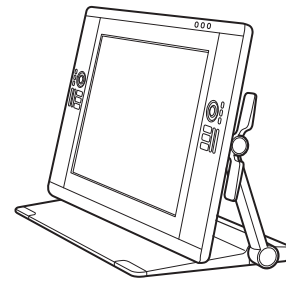

Cintiq can also be used vertically upright as a display.

[Display stand features](#)

[Display stand location](#)

[Adjusting display height and incline](#)

[Using a keyboard with Cintiq](#)

[Cable replacement](#)

DISPLAY STAND FEATURES

Locate Cintiq on your desktop or other stable work surface. Select a level [display stand location](#) where Cintiq will not tip or fall. Take some time to familiarize yourself with the display stand components.

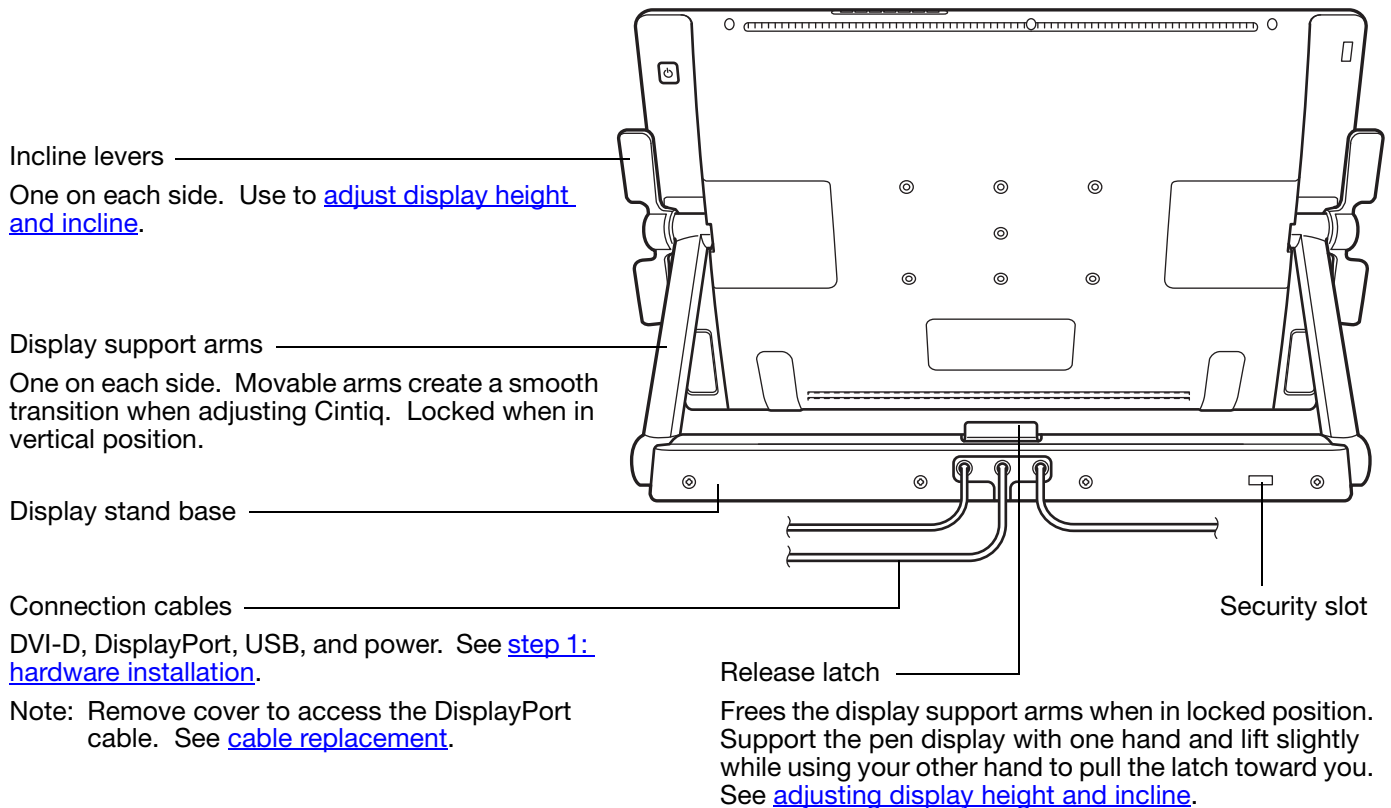

Warning

Do not lift by the incline levers or upper portion of the display support arms. Improper operation may lead to physical injury or damage to the stand. Avoid catching your finger in the gaps of the movable portions of the stand.

Always place Cintiq securely on a level, stable desktop or other working surface. Do not allow any portion of the display stand base to protrude from the installation surface. Otherwise, Cintiq may fall and cause physical damage or personal injury.

Do not place on any unsteady surface or table. Do not place on slanted areas, unstable areas, or areas where vibration is present. Physical damage or personal injury may result if this product falls from an unsuitable surface.

DISPLAY STAND LOCATION

Select a location on your desktop or other work surface that is level and stable. This product weighs approximately 29 kg (64 lbs). Any table or platform on which this product is installed must be able to support the combined weight of the Cintiq interactive pen display and Cintiq display stand.

- Before moving Cintiq, adjust the pen display [height and incline](#) so the display stand support arms are locked upright, with Cintiq positioned horizontally. Place all cables on top of the stand base and ensure they do not hang free. Tripping over loose cables can cause physical damage or personal injury.
- Request assistance from another person or persons. Each person should securely grasp the lower part of a display support arm near the display stand base. With the other hand, grasp the base of the stand at the front corner. Using care, lift and carefully move this product while supporting the base of the stand.

Important: The assembly is heavy. Do not attempt to lift Cintiq by yourself. Each person should use both hands to securely grasp the product. Grasp the stand base at the corner areas to avoid any sharp edging. DO NOT lift the pen display itself, otherwise damage might occur to the LCD if it flexes during movement. Also, the pen display does not have sufficient strength to support the load of the stand hanging freely from it. Work together, and lift carefully.

- Locate Cintiq on a desktop or other working surface that is flat, clean, and free of any moisture or oily film. Taking care not to pinch your fingers, do this by first placing the rear half portion of the stand onto the table surface. Then slide the stand fully into place so that it will not tip or fall.
- When in place, use the incline levers to rotate the display back to a vertical position.

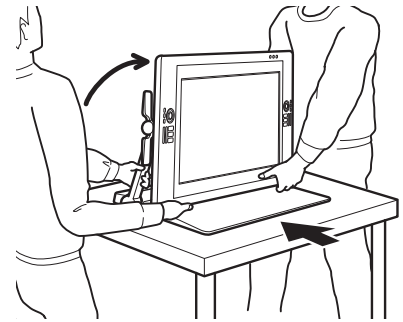
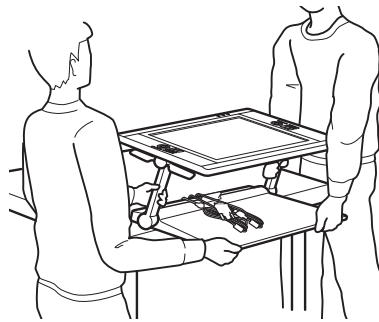
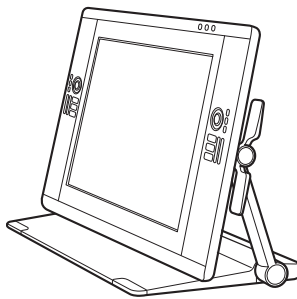

Warning

Do not lift by the incline levers or upper portion of the display support arms. Improper operation may lead to physical injury or damage to the stand. Avoid catching your finger in the gaps of the movable portions of the stand.

Place Cintiq securely on a level, stable desktop or other working surface. Do not allow any portion of the display stand base to protrude from the installation surface. Otherwise, Cintiq may fall and cause physical damage or personal injury.

Do not place this product on any unsteady surface or table. Do not place on slanted areas, unstable areas, or areas where vibration is present. Physical damage or personal injury may result if this product falls from an unsuitable surface.

Do not place this product on any wet surface or table. Doing so may cause the pads on the base of this product to slip, allowing the product to fall.



After placing Cintiq in its primary location, you can shift the unit to different positions.

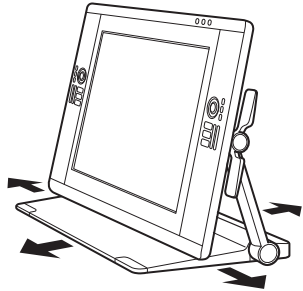

Slide the display stand on your desktop.

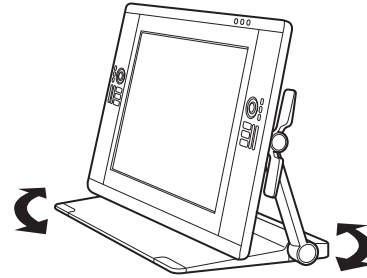

Turn from side to side.

For those who prefer a more immersive environment, Cintiq has been designed so that you can work with the pen display overhanging your desktop.

1. Adjust [height and incline](#) so the pen display is slightly above and overhanging the display stand edge.
2. Pull Cintiq toward you. As the front of the stand moves over the edge of your desktop, the friction of the base pads will increase.

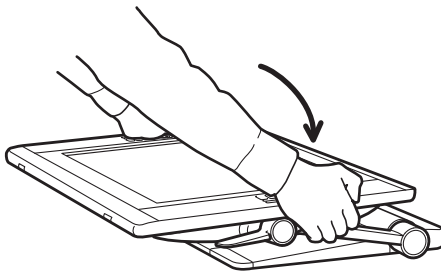

Prepare by adjusting the display to a lowered, horizontal (flat) position.

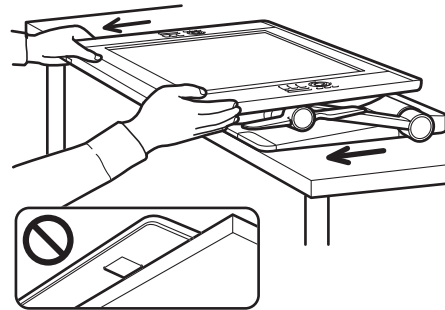

Using a smooth motion, pull Cintiq toward you. If you feel an increase in friction, stop pulling. Check to ensure the display stand base does not extend beyond desktop edge.

Caution

Use care when adjusting the working position. Use a smooth, horizontal motion when pulling Cintiq toward you. Do not lift the stand from the desktop. You can move the stand base to align with the edge of your desktop. **DO NOT** let the stand base protrude over the desktop.

If you pull too far, and as the front of the stand moves over the edge of your desktop, the friction of the base pads will increase and “lock” the stand in place. Do not pull beyond this point or past the base pads. Push the display stand back onto the working surface until the front edge of the stand base aligns with the edge of the installation surface.

Improper movement or pulling beyond the tipping point will prevent the friction lock from engaging, and could cause personal injury or damage to the pen display if it were to fall. Cintiq is heavy. Use care when moving the unit.



3. Readjust the pen display height and incline as needed.

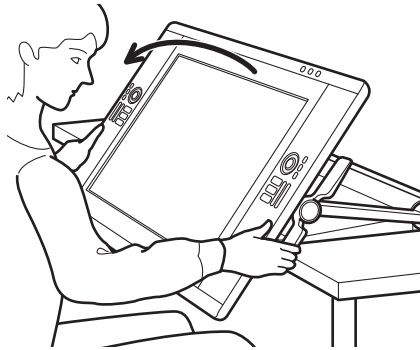

Readjust height and incline.

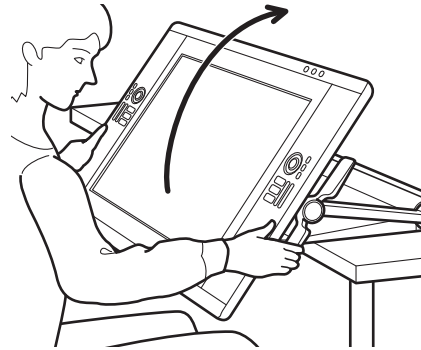

Important: Push Cintiq fully back onto desktop when done working.

4. When you are done working, use the incline levers to raise the pen display and then push Cintiq back onto your desktop. Always make sure this product is fully supported by your desktop when you are not actively working with Cintiq.



 **Caution**

When using Cintiq in a position where the display overhangs your desktop, do not push or lean against the bottom edge of the display. This could cause the stand to disengage and possibly result in personal injury or damage to the pen display if it were to fall. When you are done working, always move Cintiq fully back onto the desktop.

ADJUSTING DISPLAY HEIGHT AND INCLINE

You can adjust the pen display height and incline to best meet your needs throughout the day.

To change incline or viewing angle, face the front of the pen display and grasp it on the left and right side at approximately the same height as the incline levers. Use your fingertips to gently squeeze or pull the incline levers toward the pen display. This will release a clutch mechanism. As you squeeze the levers, tilt the pen display to adjust the viewing angle.

- Squeeze the incline levers on both sides of the pen display at the same time. For example: squeeze both lower levers, or squeeze both upper levers.
- For a flatter incline, squeeze the lower levers and gently rotate Cintiq down to the desired position.
- For a more vertical incline, squeeze the upper levers and gently rotate Cintiq up to the desired position.
- As you tilt the pen display, the support arms may travel to follow your movements.
- Release the incline levers to lock in place.
- Pay attention to how the pen display feels as you adjust incline or viewing angle. You may find instances where it is easier to use the upper levers instead of the lower, and vice versa.

Notes:

The incline levers exhibit some natural play before the clutch mechanism engages.

When tilting the display upward to a more vertical position, you may notice the stand wanting to slip forward. Use the upper incline levers and pull Cintiq slightly toward you as you tilt the display upward.

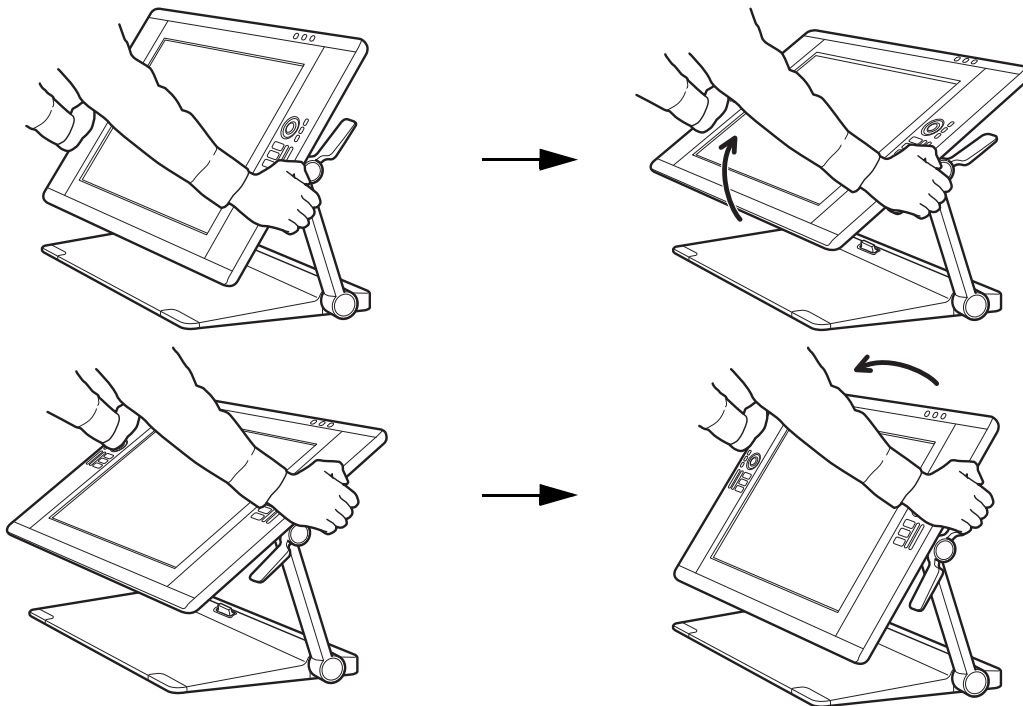

When repositioning Cintiq, face the front of the pen display and grasp it on both sides.

- Use the [incline levers](#) to adjust height and viewing angle.
- The viewing angle will change as the pen display moves through an arc created by the support arms.
- The display support arms lock in place when moved to a vertical position.

Important: The support arms lock in place **ONLY** when moved to a vertical position.

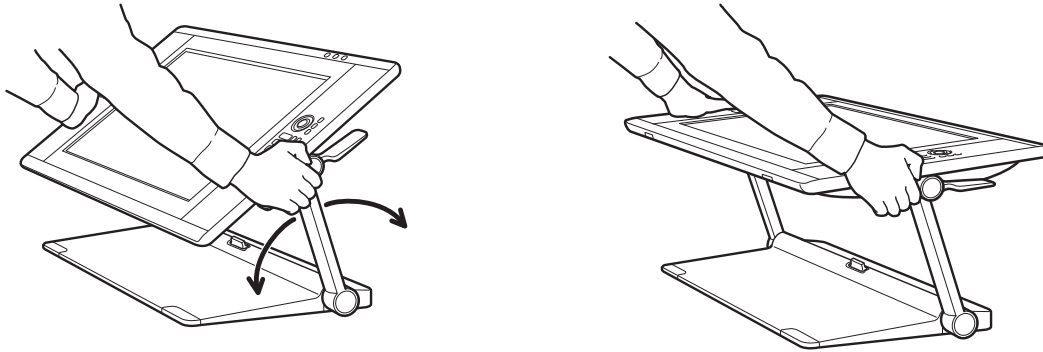

To unlock the support arms:

1. As necessary, use the incline levers to slightly raise the lower part of the pen display so you can access the release latch.
2. Support the pen display with one hand and lift slightly. Using your other hand, pull the release latch toward you. This will unlock and release the support arms for movement.

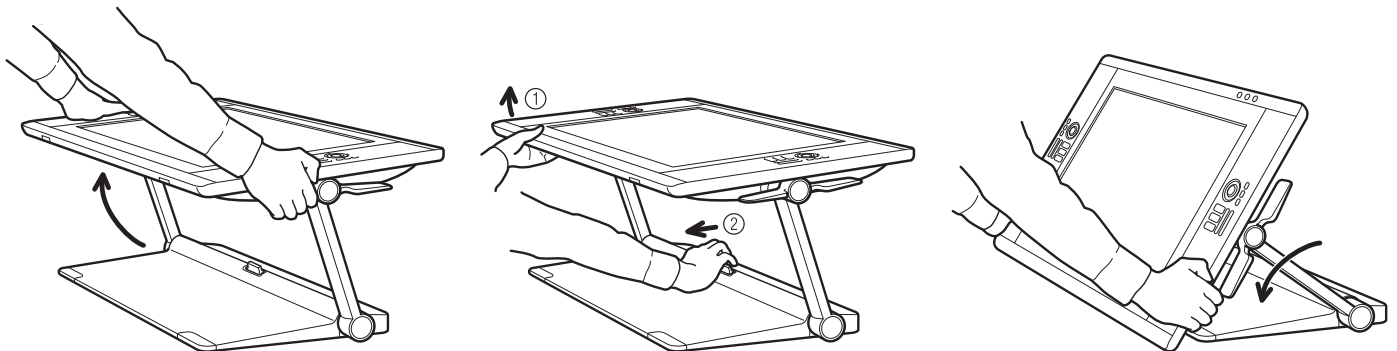

Warning

Use care when unlocking the support arms, and always support the pen display with one hand as you do so. The display comes down when the lock is released. **DO NOT** hold the support arms when releasing the lock. Improper release of the support arms from a locked position may allow the pen display to fall, and could cause personal injury or damage to the pen display.

3. Carefully lower the pen display until its lower edge rests on the display stand or your desktop.

Tip: You can extend the pen display support legs to slightly raise the pen display or allow for placement of a keyboard beneath the pen display. See [using a keyboard with Cintiq](#).



USING A KEYBOARD WITH CINTIQ

Extend the pen display support legs to allow for placement of a keyboard or other input tools beneath the pen display.

- The support legs are located beneath the pen display, one at each lower corner. Flip out and then push up slightly on each leg until it clicks into place.
- [Adjust height and incline](#) as needed. The legs should rest evenly on your desktop or work surface.
- Slide your keyboard or other input device into the opening beneath the pen display.

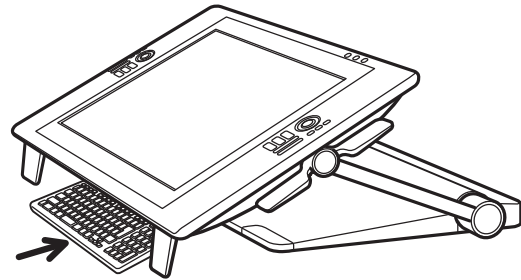
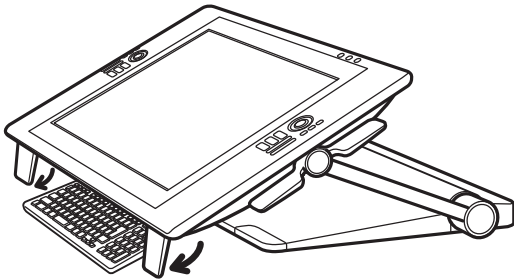

CABLE REPLACEMENT

The connection cables (DVI-D, DisplayPort, USB, and power) come pre-installed on your Cintiq.

If using a DisplayPort connection, access the DisplayPort cable by removing the back cover from the display stand.

1. Remove the screws (qty 4, Phillips) from the back cover of the display stand. Remove the back cover.
2. Extract the DisplayPort cable and set it within the center cable channel. Tuck the DVI-D cable into the stand for a clean appearance.

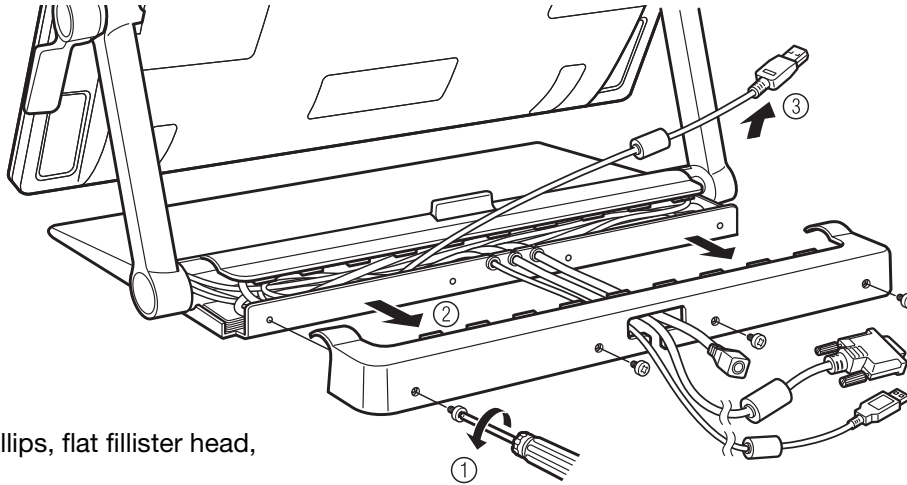

Screw type: Phillips, flat fillister head,
M3-6, black

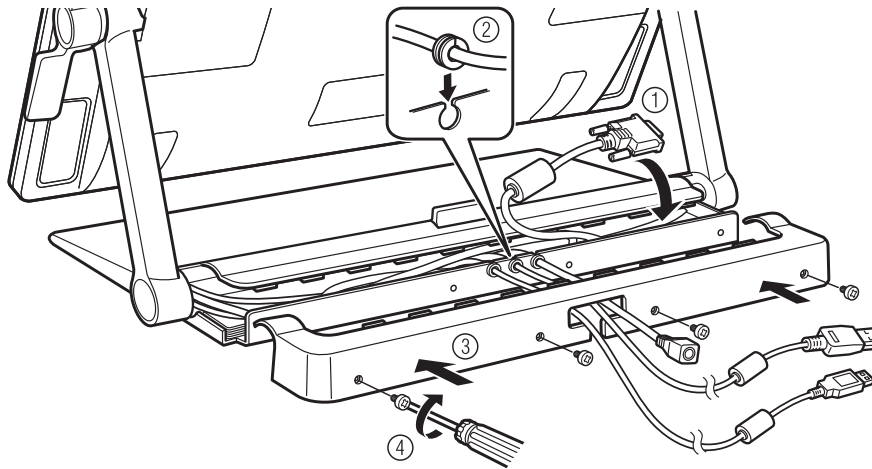

3. Replace the back cover and secure using the original screws.



There may be times when you will need to remove or replace a connection cable. For example:

- When using a VGA connection, you must remove the DVI-D cable and replace it with the provided DVI-I to VGA cable.
- When mounting Cintiq on a VESA mounting arm, and you wish to use the existing cables that come with Cintiq.
- When replacing a suspected bad cable.

To remove a cable:

1. Remove the back cover of the display stand as described above.
2. Determine which cable to remove. Cable track locations are as follows:

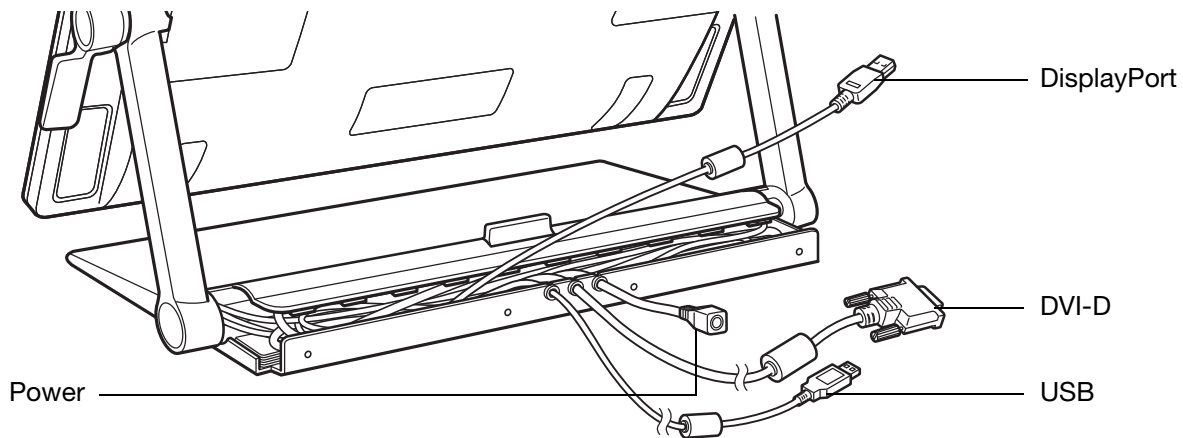

3. Remove the screws (qty 2, Phillips) from the support arm cover which houses the cable you wish to remove.
4. Raise the display support arms to the vertical locked position. Adjust the pen display incline as needed for adequate clearance. From the rear of the pen display, unclip and lift away the cable connector covering.

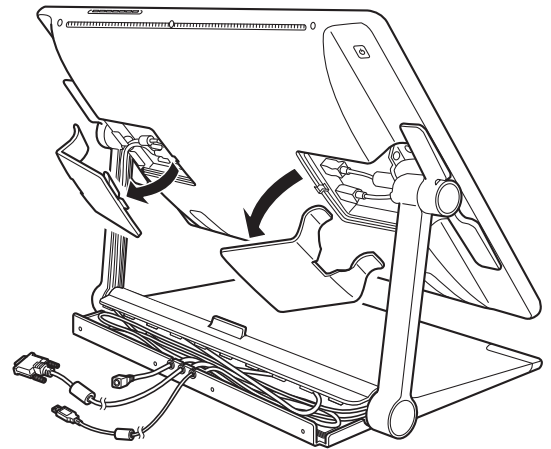
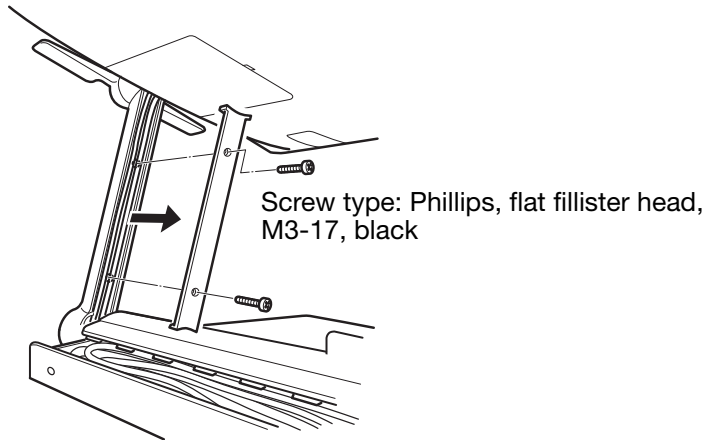

5. Carefully disconnect the cable and unthread it from the support arm cable track.

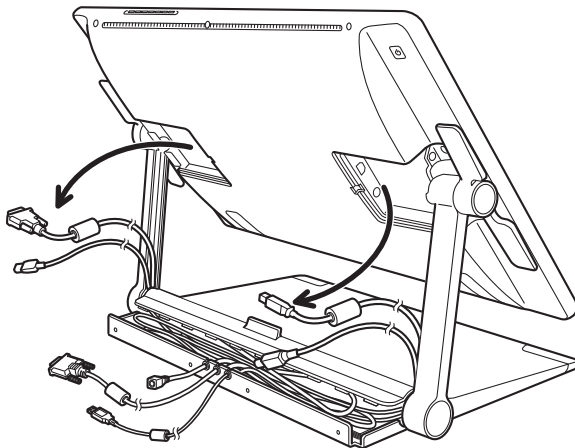

Important: When installing or replacing a cable, properly route the cable through the support arm pivots where the arm joins the pen display and the base of the stand. Proper routing will prevent the cable from getting caught in the pivot mechanism.

6. Install or replace a cable by reversing this procedure.

WORKING WITH YOUR CINTIQ

The Cintiq 24HD interactive pen display and Cintiq display stand were designed for a wide range of flexibility and ergonomic work approach. The design allows you to quickly adjust Cintiq to a different height and position whenever the need arises. Experiment by [adjusting display height and incline](#) to determine which best fits your particular working style and tasks.

As you work with Cintiq you can rest your hand lightly on the display screen, just as if it were a drawing board or sheet of paper.

Cintiq 24HD touch models allow you to work simultaneously with the pen and multi-touch. This enables you to use a pen with one hand and use your other hand for touch gestures within supporting applications.

- The pen has priority over touch. For example:
 - If you are using touch to drag an icon across the desktop and then bring the pen into proximity of the display screen surface, the pen will take control of the screen cursor.
 - If you are working with the pen and then want to use touch, first lift the pen away from the display screen surface.
- Your hand holding the pen is not recognized as a touch gesture. For best results remember to bring the pen tip into proximity before resting your hand and wrist on the display screen surface.

Because the Cintiq pen display surface will be a little higher than your desk, consider adjusting the height of your desk or chair to assure comfortable use of the device.

[Setting up your work area](#)

[Configuring Cintiq for handedness](#)

[Using the Grip Pen](#)

[Pen display controls](#)

[Working with multiple monitors](#)

[Adjusting the display](#)

See also [the multi-touch experience with Cintiq](#).

SETTING UP YOUR WORK AREA

To minimize fatigue, organize your work area to create a comfortable environment. Position Cintiq, the pen, and your keyboard for easy access without unnecessary reaching. The pen display and any other displays should be positioned so you can view them comfortably with minimum eyestrain.

- If you have not already done so, be sure to [configure Cintiq](#) for your preferred handedness.
- When using Cintiq as a display, align the top of the pen display in line with the level of your eyes.



[Adjust Cintiq](#) to a position that best meets your creative needs.

- If working with a keyboard, consider locating the keyboard slightly below the desk surface in an adjustable keyboard tray. Otherwise, see [using a keyboard with Cintiq](#).
- Maintain a good posture at all times.
- Periodically shift your gaze from your computer and focus on other objects within the room. This will help to relax your eyes.
- Use a gentle grip when working with the pen. Take short breaks between tasks to stretch and relax your muscles.
- Alternate tasks throughout the day. Minimize awkward postures and repetitive movements.
- Change your position if you feel any discomfort.
- Alternate between different modes of use. For example, every few hours adjust the Cintiq display stand to a different working position.
- Study the rest of this chapter to learn more about working with Cintiq.
- Learn about the basics of [customizing](#) Cintiq for the way you like to work.

Tips:

- Do not pull the cabling from their computer connections by accidentally moving the pen display too far from the computer.
- Cintiq can also be mounted to articulated arms or other third-party stands meeting the VESA MIS-E 100/200 (6 screw) specification for monitor stands. See [using an alternate mount or stand](#).

Note regarding Repetitive Stress Injury (RSI): Wacom makes no representation, promise or guarantee that Wacom products will cure or prevent, in whole or in part, mouse-induced repetitive stress symptoms, injuries or conditions. Individual results may vary. Always obtain competent medical advice to determine the most appropriate treatment for your specific situation.

CONFIGURING CINTIQ FOR HANDEDNESS

During the installation process, you were prompted to choose a default configuration for Cintiq based on whether you are right- or left-handed. The configuration you chose was used to determine the default settings for the ExpressKeys and Touch Rings.

However, you can use the Wacom Tablet control panel to easily reconfigure Cintiq for left- or right-handed users at any time. The ExpressKey and Touch Ring settings are automatically reconfigured when you change the handedness setting.

To reconfigure for left- or right-handed users:

1. Open the Wacom Tablet control panel and click **OPTIONS...**
2. Choose the appropriate setting for your preferred handedness.
3. Click **OK**. The existing ExpressKey and Touch Ring mode settings are swapped (or flipped) between left and right.

Notes:

The hardware control buttons are not affected when you change the handedness setting.

This procedure does not affect the default orientation. At the system log on and user switching screens, the pen display uses the default configuration you chose during the install process. To change the default configuration, you must re-install the Wacom driver.

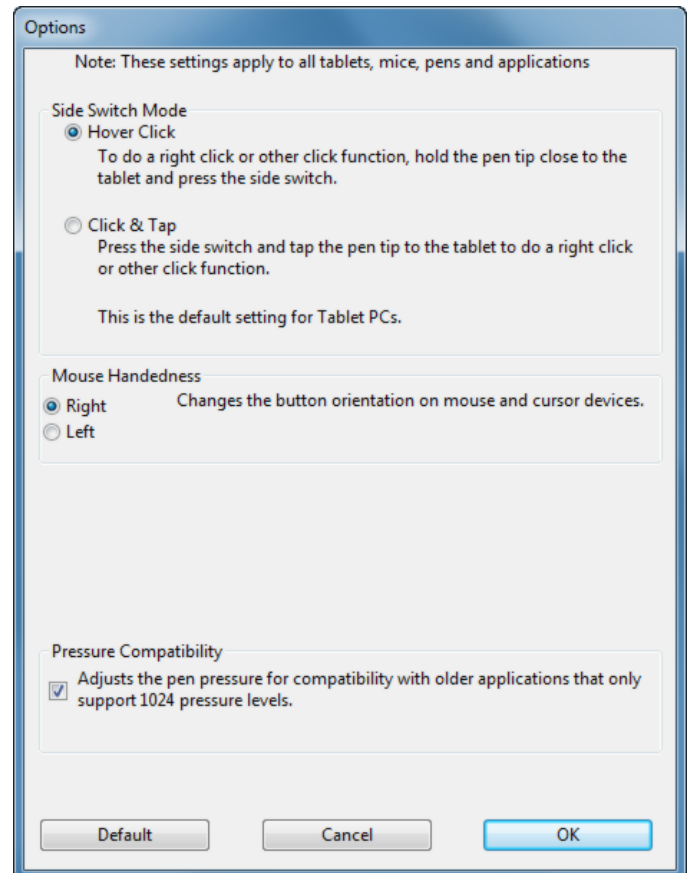

USING THE GRIP PEN



The cordless, battery-free pen senses the amount of pressure and tilt you apply to the tip. There are four basic techniques for using the pen: pointing, clicking, double-clicking, and dragging. If you are unfamiliar with using the pen, see the following pages.

Note: For Cintiq models that support both pen and multi-touch, you can simultaneously use the pen and touch when working within a supporting application. For example, you might use multi-touch with the pen when mixing colors in Photoshop. Remember, the pen has priority over touch whenever the pen tip or eraser is within proximity of the pen display screen. Lift the pen and your hand away from the display screen surface to enable touch.

If you experience unintended touch actions, manually disable touch by pressing an ExpressKey that has been set to TOUCH ON/OFF. See [customizing pen display functions](#). When done working with the pen, press the ExpressKey to enable touch. You can also use the Wacom Tablet control panel to [disable multi-touch](#).

[Holding the pen](#)

[Positioning](#)

[Clicking](#)

[Dragging](#)

[Using the side switch](#)

[Working with pressure sensitivity](#)

[Drawing with tilt](#)

[Erasing](#)

HOLDING THE PEN



Hold the pen as you would a normal pen or pencil. Adjust your grip so that the side switch is in a convenient location where you can toggle it with your thumb or forefinger. Be careful not to accidentally press the switch while drawing or positioning with the pen. Tilt the pen in any way that feels most comfortable. As you work with Cintiq you can rest your hand lightly on the display screen.

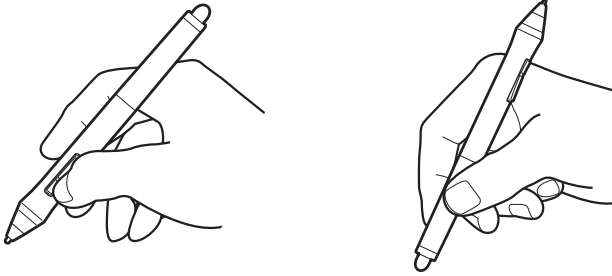

If you are working in a multi-user environment or otherwise want to personalize your pen, unscrew the tip cone and replace the colored ring with one of another color (included).

You can [customize](#) the pen settings at any time.

Place the pen stand within easy reach. When not in use, place the pen in the pen stand or lay it flat on your desk. The stand allows for vertical or horizontal placement of the pen.

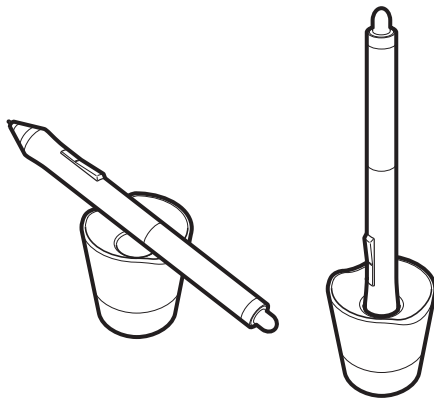

Unscrew the base of the pen stand to access the nib removal tool and assorted replacement nibs.

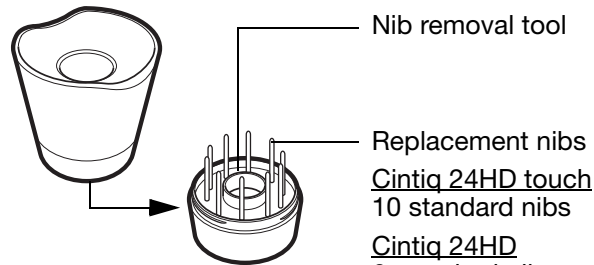

Nib removal tool

Replacement nibs

Cintiq 24HD touch

10 standard nibs

Cintiq 24HD

6 standard nibs

3 hard felt nibs

1 stroke nib

Important: To maintain the sensitivity of your pen, do not store it in a container where it will rest on the tip or eraser. Improper storage may damage the pen tip pressure sensor(s).

POSITIONING



To position the screen cursor, move the pen slightly above the Cintiq display screen without touching the screen surface. Press the pen tip on the display screen to make a selection.

Note: [Calibrating the pen display](#) ensures correct alignment of the screen cursor with the pen tip. If the screen cursor does not jump to a position near the pen tip when you place the pen on the display screen, then the pen display software driver may not be installed or is not loading. Install the driver software if necessary. Otherwise, see [troubleshooting](#).

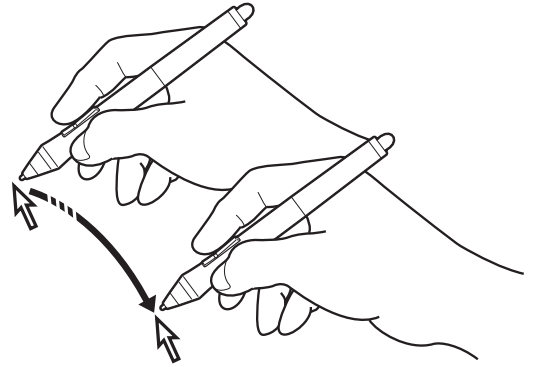

CLICKING



Tap the display screen once with the pen tip, or touch the pen to the display screen with enough pressure to register a click.

Tip: Configure Windows to select when hovering the pen over an icon and to launch the icon with a single click. To turn on this feature, first open a folder.

Windows 7 and Vista: From the ORGANIZE pull-down menu choose FOLDER AND SEARCH OPTIONS. From the GENERAL tab select SINGLE-CLICK TO OPEN AN ITEM (POINT TO SELECT).

Windows XP: From the TOOLS pull-down menu choose FOLDER OPTIONS.... From the GENERAL tab select SINGLE-CLICK TO OPEN AN ITEM (POINT TO SELECT).

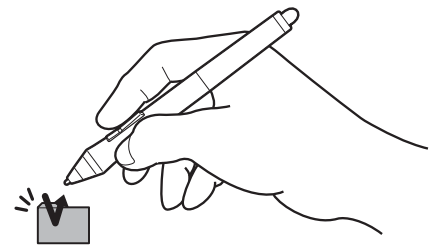

Press the upper side switch (when set to DOUBLE CLICK), or quickly tap the display screen twice in the same place with the pen tip. Double-clicking is easier when using the pen perpendicular to the pen display screen.

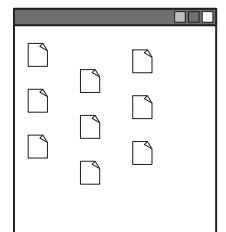
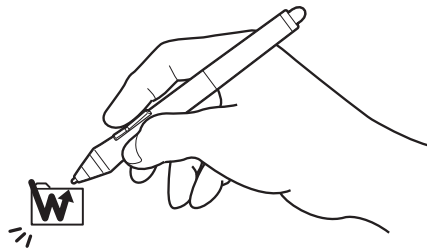

DRAGGING



Select an object, then slide the pen tip across the display screen to move the object.

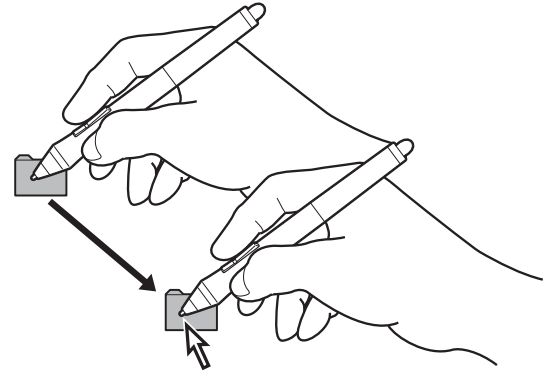

USING THE SIDE SWITCH



The pen comes equipped with a side switch. This switch has two customizable functions that can be selected by rocking the switch in either direction. You can use the side switch whenever the pen tip is within proximity (5 mm (0.2 inch)) of the display screen surface. You do not need to touch the pen tip to the display surface in order to use the switch. By default, the upper switch is set to DOUBLE CLICK, and the lower switch is set to RIGHT CLICK. You can [customize](#) or disable the switch functions using the Wacom Tablet control panel.

WORKING WITH PRESSURE SENSITIVITY



The pen responds to the nuance and inflection of your hand movements, enabling you to create natural-looking pen and brush strokes within applications that support this feature.

To draw, ink, or write with pressure sensitivity, move the pen along the display screen surface while applying various amounts of pressure downward on the tip of the pen. Press hard for thick lines or dense color. Press gently for thin lines or softer color. Some applications require that you first select a pressure-sensitive tool from the application tool palette.

To adjust tip feel, see [adjusting tip feel and double-click](#).

Visit the Wacom web site to learn about applications that support pressure. See [product information](#).

DRAWING WITH TILT



The pen display recognizes when you tilt the pen from vertical to incline positions. Tilt can be used to control line shape and thickness in supporting applications.

Visit the Wacom web site to learn about applications that support tilt. See [product information](#).

ERASING



In supporting applications the pen eraser works like the eraser on a pencil. In text applications, use the eraser to select text and then lift the eraser from the pen display screen to delete the text.

Visit the Wacom web site to learn about applications that support the eraser. See [product information](#). If the eraser is not supported in an application, you can still use the eraser for positioning, drawing, or annotation.

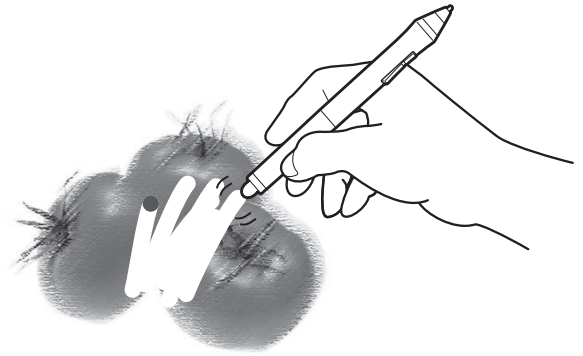

PEN DISPLAY CONTROLS

To improve your workflow in graphics or other applications, Cintiq features ExpressKeys and Touch Rings. While using your dominant hand for multi-touch or pen input, you can simultaneously use your other hand to operate the ExpressKeys or Touch Rings.

Hardware control buttons

Press a button to activate the assigned function. See [using the hardware control buttons](#).

Touch Rings

Slide your finger over the Touch Rings to zoom, scroll, or issue assigned keystroke actions. See [using the Touch Rings](#).

Active area

Touch Ring mode buttons

Press to choose a Touch Ring function.

Status LEDs show the active mode.

As you press each button, an overlay appears briefly on your display screen to show the button function assignments.

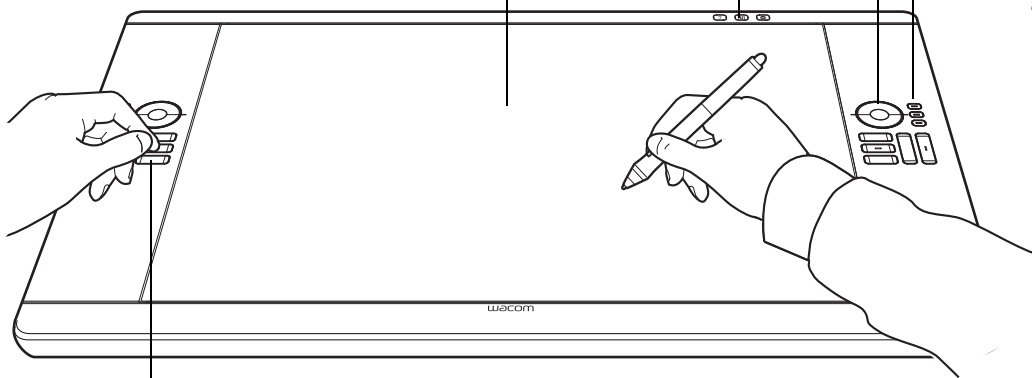

ExpressKeys

Press the customizable keys to perform frequently used functions or keystrokes, or to emulate button clicks or modifier keys. See [using the ExpressKeys](#).

A [Display Toggle](#) function is available for use on multiple monitor systems. This feature enables you to toggle the screen cursor between Cintiq and your other displays. For example: Cintiq can be used as a pen display where the cursor is positioned at the pen tip location, or toggled for use as a standard Wacom tablet where the cursor can be moved across the entire desktop or any display on your system.



Depending on your product model, Cintiq can accept pen input or both pen and multi-touch input.

Pen input

Wherever you place the pen on the display screen surface, the screen pointer will jump to the corresponding point.

Learn about [using the Grip Pen](#).

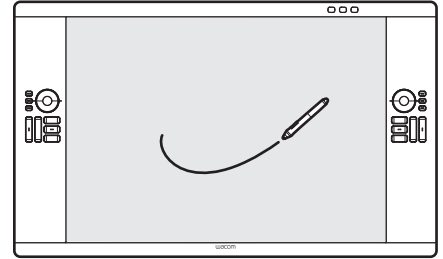

Multi-touch

On touch-sensitive models you can:

- Use your finger(s) on the display screen surface to position the screen pointer. The cursor jumps to wherever you touch the screen surface.
- Click or right-click.
- Scroll and zoom.
- Move between pages in most web browsers, document, or picture viewers.
- Display the Radial Menu.
- Switch between applications and perform other desktop functions.
- Save your work.
- View your Cintiq settings.

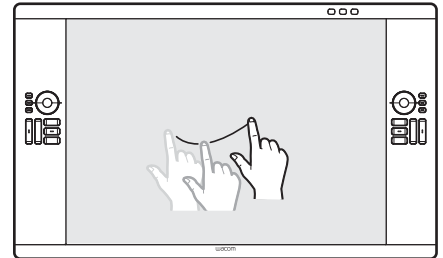

Some gestures can be customized.

Learn about [the multi-touch experience with Cintiq](#).

For models that support both pen and multi-touch:

You can simultaneously work with the pen and touch in supporting applications. For example, you might use touch to turn a 3D object while using the pen to sculpt a surface texture. Remember, the pen has priority over touch whenever the pen tip or eraser is within proximity of the pen display screen. Lift the pen and your hand away from the display screen surface to enable touch.

USING THE HARDWARE CONTROL BUTTONS

Press a button to:

- Toggle multi-touch on or off.
- Launch the Wacom Tablet control panel or an on-screen keyboard.
- Display a diagram of your current Cintiq settings.

Press the button again to toggle off the function.

Cintiq 24HD touch: Toggles touch on or off.

Cintiq 24HD: Launches the Wacom Tablet control panel.
Press to close the control panel when open.

Launches the on-screen keyboard. Press to close the keyboard when open.

Shows (on your display screen) a diagram of the pen display ExpressKey, Touch Ring, and pen settings. The current functions for each control are shown. Press to dismiss the diagram.

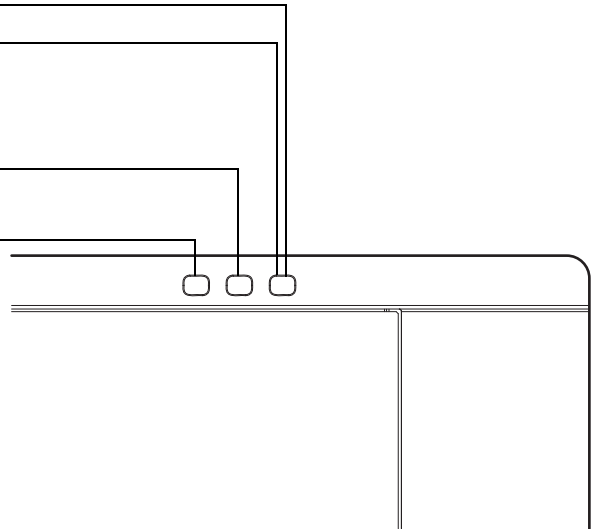

Notes:

- You may notice a slight delay in response time, depending on the speed of your computer.
- The control buttons cannot be customized.

USING THE EXPRESSKEYS

Press individual keys to perform frequently used functions or keystrokes. ExpressKeys can also be used to modify your pen, touch, or other input tool properties as you work. If your product supports [multi-touch](#), you can also use gestures to perform many of these functions.

Default settings are shown by ExpressKey number below.

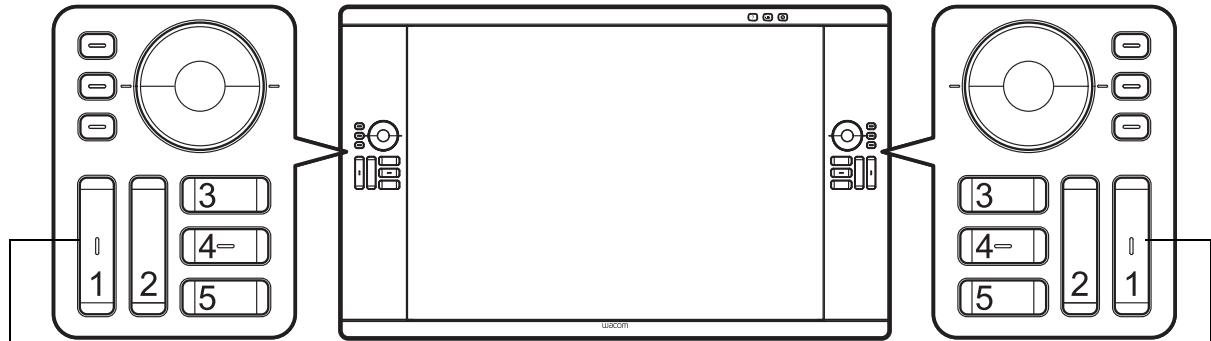

1. SHIFT
2. ALT/OPT
3. [RADIAL MENU](#)
4. CTRL/COMMAND
5. [PAN/SCROLL](#) (space)

1. UNDO (CTRL/COMMAND+Z)
2. REDO (CTRL/COMMAND+Y)
3. BRUSH PANEL (F5)
4. [PRECISION MODE](#)
5. [DISPLAY TOGGLE](#)

Right-handed configuration shown. For left-handed configuration, the ExpressKey settings are swapped (or flipped) between left and right.

Note: The ExpressKeys can be operated in combination with one another. For example, customize one key for the CTRL function and another for ALT. When you press both keys at the same time a CTRL+ALT function is initiated.



Tips:

- Use the [Radial Menu](#) to expand the functionality of your Cintiq.
- Display an interactive diagram of the current pen display settings by pressing the appropriate [hardware control button](#) at the top of the pen display. You can also press an ExpressKey or other tool button set to [SETTINGS](#).

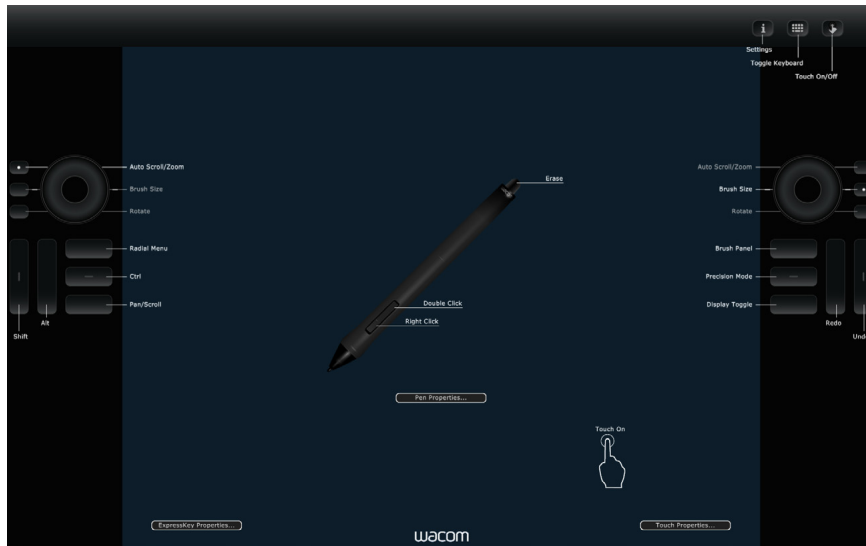

Settings may vary depending on your product model.

Consider some of these other ways to use the ExpressKeys:

- Set a key to a commonly used keyboard shortcut.
- Set a key to launch a commonly used file or application.
- If you prefer not to (or cannot) use the side switches on your Grip Pen, then set a key to right- or double-click.
- Choose from any of the other available [functions](#). See [customizing the ExpressKeys](#).

Important: Some applications can override and control the ExpressKey functions. For details, see [using applications integrated for tablet control](#).

Use the Wacom Tablet control panel to customize the ExpressKey options.

[Manage your control panel settings](#)

[Control panel overview](#)

[Customizing the ExpressKeys](#)

USING THE TOUCH RINGS

Slide your finger around the ring to zoom in or out, scroll up or down, or to issue the assigned keystroke functions.



Example of zooming in

Move your finger clockwise along the ring to zoom in or scroll down in most applications. Tap the upper portion of the Touch Ring for single increment changes based on the assigned function.



Example of zooming out

Move your finger counter-clockwise to zoom out or scroll up. Tap the lower portion of the Touch Ring for single increment changes.

Press a Touch Ring mode button to switch between three customizable states. Status LEDs show the active mode.

As you press each button, an overlay appears briefly on your display screen to show the button assignments.

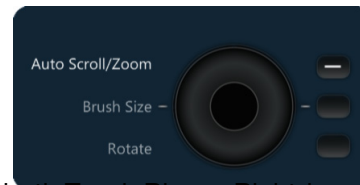

Tap upper or lower portion of ring for incremental changes.

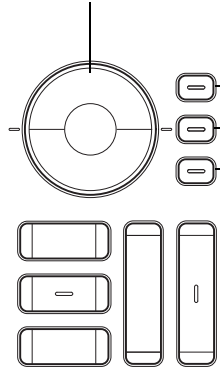

Default settings are the same for both Touch Rings. Right-handed configuration shown:

Top button: AUTO SCROLL/ZOOM. Sets the ring to zoom in graphics applications and scroll in other applications.

Some applications may interpret zooming as scrolling, or may completely ignore zooming. Similarly, scrolling may be interpreted as zooming, or ignored completely.

Middle button: BRUSH SIZE. Sets the ring to increase or decrease the brush size of your drawing tool when working in Adobe Photoshop.

Bottom button: CANVAS ROTATION. Enables you to rotate or flip an entire image when working in Adobe Photoshop CS4 or later.

Note: In some regions the defaults may vary, depending on application and operating system differences. See [customizing the Touch Rings](#) to modify how the Touch Rings work.

For left-handed configuration, the Touch Ring mode settings are swapped (or flipped) between left and right.

Important: Some applications can override and control the Touch Ring functions. For details, see [using applications integrated for tablet control](#).

Use the Wacom Tablet control panel to customize the Touch Ring options.

[Manage your control panel settings](#)

[Control panel overview](#)

[Customizing the Touch Rings](#)

WORKING WITH MULTIPLE MONITORS

When working with Cintiq and additional monitors on the same system, the screen cursor movement on the standard monitors will depend on your system configuration.

If a second monitor is connected in mirror mode, both Cintiq and the other monitor will show identical images and screen cursor movement.

If you are using Cintiq with other monitors in extended monitor mode, you have several options for navigating on the other monitors:

- Set an ExpressKey or pen side switch to the DISPLAY TOGGLE function. You can then press the button to toggle the screen cursor between Cintiq and your other displays.

For example: Cintiq can be used as a pen display where the screen cursor is positioned at the pen tip location on the pen display screen surface. [Display Toggle](#) enables you to use Cintiq as a standard Wacom tablet where the screen cursor can be moved across the entire desktop or additional displays.

- Set a pen side switch or an ExpressKey to MODE TOGGLE. You can then quickly switch between pen mode for working on Cintiq and mouse mode for working on the other monitors.

You can also purchase an Intuos5 tablet and use it to work on the other monitors in PEN mode. The pen will work on both Cintiq and the tablet.

ADJUSTING THE DISPLAY

Use the Cintiq controls to adjust a variety of display settings.

[Factory presets, auto-sync, and user settings](#)

[On Screen Display \(OSD\) settings](#)

[OSD controls, Cintiq 24HD touch](#)

[OSD controls, Cintiq 24HD](#)

[Power saving](#)

FACTORY PRESETS, AUTO-SYNC, AND USER SETTINGS

Factory presets: For optimal display quality, set your video card to a resolution of 1920x1200. This is the maximum (native) resolution that can be used with Cintiq. See the Important Product Information guide for details.

Auto-sync: Cintiq automatically synchronizes to the incoming signal. The auto-sync function sets the horizontal and vertical screen position, as well as pitch and phase. Auto-sync will function between the supported horizontal and vertical frequency ranges. See the Important Product Information guide for details.

If Cintiq does not automatically synchronize with the incoming signal, you can use the OSD AUTO ADJUST option to initiate display synchronization. Further screen display adjustments can be manually made using the On Screen Display (OSD) controls.

Color calibration: Changing the color, color temperature, contrast, brightness, or backlight from their default settings will override the color profile used with Cintiq.

ON SCREEN DISPLAY (OSD) SETTINGS

The OSD function enables you to optimize a variety of pen display settings at the touch of a button. Use the OSD controls, located on the upper edge of the pen display, to make adjustments.

- To open or exit the OSD menu, press the MENU button.
- Use the selection buttons to navigate and select an option.
- To choose an option, press the SELECT button.

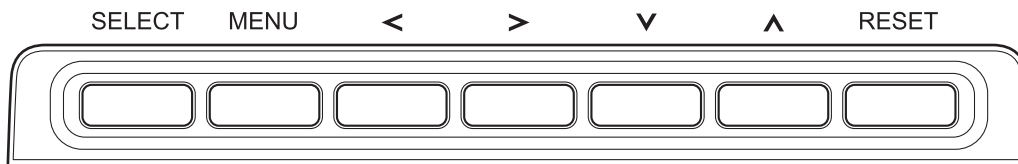

BUTTON	FUNCTION
SELECT	Activates the selected OSD menu option.
MENU	Opens or exits the OSD menu.
left/right	Navigates to the left or right through the OSD menu.
up/down	Navigates up or down through the OSD menu. Increases or decreases selected item values.
RESET	Returns the OSD back to factory settings.

Notes:

The OSD menu will automatically close after a few moments of inactivity. You can also press the MENU button to close the menu. All settings are automatically saved when the OSD menu closes and will be used the next time the pen display receives a similar video signal. This is applicable to all display modes.

If you make changes to the display appearance and cannot return to the original settings, use the RESET option to return the pen display to its original factory defaults.

[OSD controls, Cintiq 24HD touch](#)

[OSD controls, Cintiq 24HD](#)

OSD CONTROLS, CINTIQ 24HD TOUCH

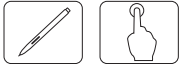

Menu and other control options are available when you open the On Screen Display.

[Brightness/Contrast controls](#)

[Auto Adjust \(analog input only\)](#)

[Image controls](#)

[Color control systems](#)

[Tools](#)

[Menu tools](#)

[ECO Information](#)

[Information](#)

[OSD Warning](#)

[Using the Picture Mode function](#)

[Advanced OSD](#)

BRIGHTNESS/CONTRAST CONTROLS



BRIGHTNESS. Adjusts the overall image and background screen brightness.

Notes:

The brightness level is adjusted using the backlight output. The display will digitally compensate for low or high brightness levels. If digital compensation occurs, the brightness value on the OSD will change to magenta.

Optimal display performance will be in the range where the OSD brightness value is black. When the display cannot achieve the desired brightness, the numerical brightness value on the OSD will blink.

For low brightness settings, the display will automatically compensate by adjusting the screen contrast to achieve the desired brightness. This will result in a reduced contrast ratio and the OSD indicator will change to magenta.

For high brightness settings, the display will automatically compensate by turning down uniformity compensation in order to achieve the desired brightness. The OSD indicator will change to magenta and this may result in decreased uniformity.

CONTRAST (analog input only). Adjusts the overall image and background screen brightness by input signal level.

Note: It is recommended that you use BRIGHTNESS to adjust screen brightness for lower power consumption and improved image quality.



ECO MODE. Decreases the amount of power consumed by reducing the brightness level.

OFF: No function.

MODE1: Decreases the brightness range up to 200 cd/m².

MODE2: Decreases the brightness range up to 100 cd/m².

BLACK. Adjusts the black luminance. When low settings are selected that cannot be displayed, the indicator on the OSD will turn magenta.

AUTO ADJUST (ANALOG INPUT ONLY)



AUTO ADJUST (analog input only). Automatically adjusts the Image Position, H.SIZE settings, and FINE settings.

AUTO CONTRAST (analog input only). Adjusts the image displayed for non-standard video inputs.

IMAGE CONTROLS



LEFT / RIGHT. Controls Horizontal Image Position within the display area of the LCD.

DOWN / UP. Controls Vertical Image Position within the display area of the LCD.

H.SIZE (V.SIZE) (analog input only). Adjusts the horizontal size by increasing or decreasing this setting.

If the AUTO ADJUST function does not give you a satisfactory picture setting, a further tuning can be performed using the H.SIZE (or V.SIZE) function (dot clock). For this, a moiré test pattern may be used. This function may alter the width of the picture. Use Left/Right Menu to center the image on the screen. The image should be homogeneous.

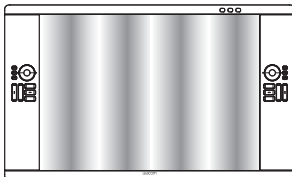

H.SIZE value is wrong.

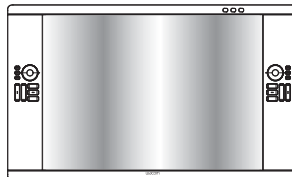

H.SIZE value is improved.

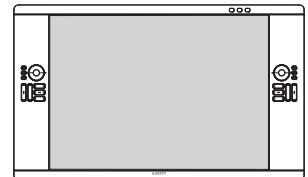

H.SIZE value is correct.



FINE (analog input only). Improves focus, clarity, and image stability by increasing or decreasing this setting.

If the AUTO ADJUST function and the H.SIZE function do not give you a satisfactory picture setting, a fine tuning can be performed using the FINE function. For this, a moiré test pattern may be used. The image should be homogeneous.

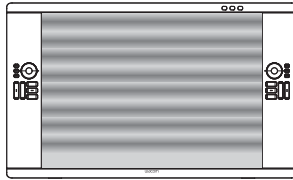

FINE value is wrong.

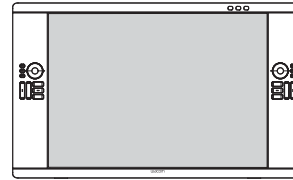

FINE value is correct.

AUTO FINE (analog input only). This function automatically and periodically adjusts the FINE setting for change in signal condition. This function adjusts approximately every 33 minutes.

EXPANSION. Sets the zoom method.

FULL: The image is expanded to 1920 x 1200, regardless of the resolution.

ASPECT: The image is expanded without changing the aspect ratio.

OFF: The image is not expanded.

CUSTOM: See the [advanced OSD](#) menu for detailed instructions.

SHARPNESS. This function is digitally capable of keeping a crisp image at any time. It is continuously adjustable to get as distinct or as soft an image as you prefer and is set independently by different timings.

COLOR CONTROL SYSTEMS



PICTURE MODE. Change the picture mode that is most suitable for the type of content that is shown. You can change up to 5 types. See [advanced OSD](#) Tag1 PICTURE MODE and [using the Picture Mode function](#) for more information.

WHITE. Adjust the white temperature by NATIVE, or by increasing or decreasing this setting. A lower color temperature will make the screen reddish and a higher color temperature will make the screen bluish. NATIVE is the default color temperature of the LCD panel. 6500K is recommended for general graphic design. 5000K is recommended for print matching.

ADJUST.

HUE: Adjusts the hue of each color^{*1}. The change in color will appear on screen and the menu color bars will show the amount of adjustment.

SATURATION: Adjusts the color depth of each color^{*1}. Press the right button and the color vividness increases.

OFFSET: Adjusts the color brightness of each color^{*1}. Press the right button and the color brightness increases.

^{*1} RED, YELLOW, GREEN, CYAN, BLUE and MAGENTA.

ADVANCED SETTING.

Shows the ADVANCED MENU. See [advanced OSD](#) for detailed information. Set PICTURE MODE in detail using Tag1 options.

TOOLS

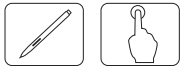

PIP MODE. Select PIP MODE, OFF/PIP/PICTURE BY PICTURE - ASPECT/PICTURE BY PICTURE - FULL. You can select an individual PICTURE MODE in each screen. This unit can display 2 inputs at a time.

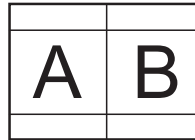

OFF

PIP
(Picture In Picture)

PICTURE BY PICTURE - ASPECT



PICTURE BY PICTURE - FULL

PIP INPUT. Selects the PIP input signal.

PIP LEFT/RIGHT. When you select “PIP” in PIP MODE, you can control the horizontal position of PIP display area.

PIP DOWN/UP. When you select “PIP” in PIP MODE, you can control the vertical position of PIP display area.

PIP SIZE. Selects the size of the sub-picture used in PIP MODE.

DVI SELECTION. Allows you to choose an appropriate mode for the video connection in use: DIGITAL, ANALOG, or AUTO. You can also set the DVI selection in the [advanced OSD](#) menu, Tag6.

EDID EXTENSION (digital input only). A communication setting with input device, containing signal timing.

NORMAL: When a PC or other computer equipment is connected, select “Normal”.

ENHANCED: Alternate setting for non-PC devices such as DVD players or game consoles. When a DVD player or other type of high definition device is connected, select “Enhanced”.

Note: Interlaced signals (480i, 576i, 1080i) are not supported. If you have any problems, see [Troubleshooting](#). When EDID EXTENSION has been changed, the connected equipment has to be restarted.

VIDEO DETECT. Selects the method of video detection when more than one video input is connected.

FIRST: When the current video input signal is not present, then the display searches for a video signal from the other video input port. If the video signal is present in the other port, then the display switches the video source input port to the new found video source automatically. The display will not look for other video signals while the current video source is present.

LAST: When the display is showing a signal from the current source and a new secondary source is supplied to the display, then the display will automatically switch to the new video source. When current video input signal is not present, then the display searches for a video signal from the other video input port. If the video signal is present in the other port, then the display switches the video source input port to the new found video source automatically.

NONE: The display will not search the other video input port unless the display is turned on.



OFF TIMER. Display will automatically power-down when you have selected a pre-determined amount of time. Before powering off, a message will appear on the screen asking if you want to delay the turn off time by 60 minutes. Press any OSD button to delay the power-down time.

OFF MODE. The Intelligent Power Manager allows the display to enter into a power saving mode after a period of inactivity. OFF MODE has three settings:

OFF: Display does not go into power save mode when the input signal is lost.

STANDARD: Display enters power save mode automatically when the input signal is lost.

When in power save mode, the LED on the front of the display blinks orange. While in power save mode, push any of the OSD control buttons, except for POWER and SELECT to return to normal.

MENU TOOLS



LANGUAGE. OSD control menus are available in eight languages.

OSD LEFT/RIGHT. You can choose where you would like the OSD control image to appear on your screen. Selecting OSD Location allows you to manually adjust the position of the OSD control menu left or right.

OSD DOWN/UP. You can choose where you would like the OSD control image to appear on your screen. Selecting OSD Location allows you to manually adjust the position of the OSD control menu Up or Down.

OSD TURN OFF. The OSD control menu will stay on as long as it is in use. You can select how long the display waits after the last touch of a button to shut off the OSD control menu. The preset choices are 10-120 seconds by 5-second increments.

OSD LOCK OUT. This control completely locks out access to all OSD control functions. When attempting to activate OSD controls while in the Lock Out mode, a screen will appear indicating the OSD controls are locked out. There are four types of OSD Lock Out:

OSD LOCK OUT with no control: To activate the OSD LOCK OUT function, press SELECT, then right button and hold down simultaneously. To deactivate the OSD LOCK OUT, press SELECT, then right button and hold down simultaneously while in the OSD menu. No controls can be adjusted while in the lock out mode.

OSD LOCK OUT with BRIGHTNESS (only) control: To activate the OSD LOCK OUT function, press SELECT, then the down and left buttons and hold down simultaneously. To deactivate the OSD LOCK OUT, press SELECT, then the down and left buttons and hold down simultaneously while in the OSD menu. BRIGHTNESS can be adjusted while in this lock out mode.

CUSTOM: Refer to the [advanced OSD](#) menu.

OSD TRANSPARENCY. Adjusts the transparency of the OSD menu.





RESOLUTION NOTIFIER. This optimal resolution is 1920 x 1200. If ON is selected, a message will appear on the screen after 30 seconds, notifying you that the resolution is not at 1920 x 1200.

HOT KEY. You can adjust the brightness directly. When this function is set to ON, you can adjust the brightness with the left or right buttons while the OSD menu is off. The standard OSD can be accessed with the MENU button. When this function is set to OFF, some display buttons are disabled.

FACTORY PRESET. Selecting FACTORY PRESET allows you to reset all OSD control settings back to the factory settings. Individual settings can be reset by highlighting the control to be reset and pressing the RESET button.

ECO INFORMATION



CARBON SAVINGS: Displays the estimated carbon savings information in kg.

COST: Displays the electricity cost savings in balance.

CARBON CONVERT SETTING: Adjusts the carbon footprint factor in the carbon saving calculation. This initial setting is based on the OECD (2008 Edition).

CURRENCY SETTING: Displays electricity pricing (available in 6 currency units).

CURRENCY CONVERT SETTING: Allows for localization of the electricity costs for accurate information in the electrical rate savings.

Note: How to change CURRENCY SETTING & CURRENCY CONVERT SETTING for Cost Meter. The initial setting is Currency setting = US\$ and the Currency Convert setting = \$0.11. This setting can be changed using the ECO INFORMATION menu. If you want to use the French setting, refer to the steps below:

1. Open menu by pressing the MENU button and select the ECO INFORMATION menu using the left or right button.
2. Select CURRENCY SETTING item by pressing the up or down button.
3. The French currency unit is Euro (€). Adjust the currency setting to Euro icon (€) from US dollar (\$) icon using the left or right button in the Current setting item.
4. Select CURRENCY CONVERT SETTING item using the up or down button.
5. This initial Euro (€) setting is Germany of OECD (2007 Edition).
6. Check receipt of French's electricity prices or OECD data for French. French of OECD (2007 Edition) was 0.12.
7. Adjust the CURRENCY CONVERT SETTING item using the right or left button.





INFORMATION



Provides information about the current resolution display (main picture), current input setting and technical data including the preset timing being used and the horizontal and vertical frequencies. Indicates the model and serial numbers of your display.

OSD WARNING



OSD warning menus disappear with use of the MENU button.

NO SIGNAL: This function gives a warning when there is no Horizontal or Vertical Sync. After power is turned on or when there is a change of input signal, the NO SIGNAL window will appear.

RESOLUTION NOTIFIER: This function warns if resolution other than the optimized resolution is used. After power is turned on or when there is a change of input signal or the video signal does not have proper resolution, the RESOLUTION NOTIFIER window will open. This function can be disabled in the MENU TOOLS.

OUT OF RANGE: This function gives a recommendation of the optimized resolution and refresh rate. After the power is turned on or there is a change of input signal or if the video signal does not have proper timing, the OUT OF RANGE menu will appear.

LUMINANCE WARNING: When the backlight cannot display the desired luminance, a message will appear on the display. To avoid this, reduce the BRIGHTNESS level.

INTERLACED SIGNALS ARE NOT SUPPORTED: This function gives a warning when the interlace signal is used. While the image is visible, change the signal of the device from interlaced to progressive (non-interlaced). See [display troubleshooting](#).

If you need detailed information about the controls, use the [advanced OSD](#) menu.

USING THE PICTURE MODE FUNCTION



Choose the picture mode that is most suitable for the type of content that is shown. Modes include: sRGB, Adobe®RGB, DCI, REC-BT709, NATIVE, FULL, DICOM, PROGRAMMABLE, eciRGB_v2.

- To access the picture mode, press the RESET button while the OSD menu is not showing.
- Each PICTURE MODE includes BRIGHTNESS, WHITE, color gamut, GAMMA, BLACK, UNIFORMITY, COLOR VISION EMU, METAMERISM, RESPONSE IMPROVE settings. You can change these settings in Tag1 of the [advanced OSD](#) menu.



Type of PRESET

PRESET	PURPOSE
sRGB	Standard color space used for the Internet, Windows operating systems and digital cameras. Recommended setting for general color management.
Adobe®RGB	Provides a standard color space used in high-end graphics applications such as digital still cameras and imaging. It provides the highest level of color matching to other output devices. Recommended setting for applications that support color management features such as Mac or Adobe.
DCI	Color setting for digital cinema.
REC-Bt709	Color setting for High-definition television.
NATIVE	Factory setting. Highest brightness setting. Provides lowest power consumption when kept at factory setting.
FULL	Well-balanced image performance settings. Native panel color gamut.
DICOM	Medical settings for X-ray imaging view.
PROGRAMMABLE	For Color Calibration Software or the Hardware Calibration settings (some OSD settings are disabled).
eciRGB_v2	Color setting intended mainly for the print and publishing industry.

Notes:

When selected, PICTURE MODE is different from your computer's ICC color profile. You may experience inaccurate color reproduction.

Color Calibration Software, developed by Wacom, is highly recommended to provide extended color management features such as ICC profile Emulation and Printer Emulation. Contact your supplier for more information about this software.

It is recommended to do so within the first 1000 hours of display usage, when using calibration hardware for the first time.

When PICTURE MODE is locked, "PICTURE MODE IS LOCKED" appears on screen. To unlock PICTURE MODE settings, press the SELECT and up buttons at the same time.

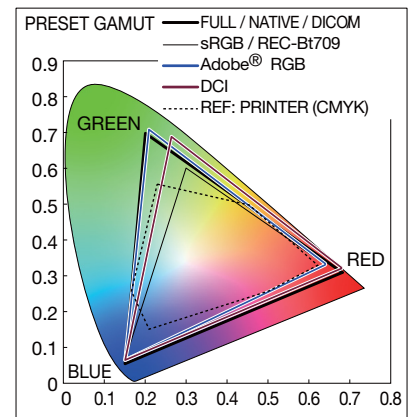

ADVANCED OSD



If you need detailed information about the controls, use the advanced menu. There are two ways to use the advanced menu.

Way 1: Using the advanced menu

- Press the MENU button to access the OSD menu. Use the OSD buttons to move the cursor to the ADVANCED SETTING in Color control systems. Press the SELECT button to display the advanced menu.

Way 1: Exiting the advanced menu

- Press the MENU button.

Way 2: Using the advanced menu

- Turn off your display.
- Turn on your display by pushing the POWER and SELECT buttons at the same time for at least one second simultaneously. Then press the control buttons (MENU, left, right, up, down).
- You will see the Advanced menu. This menu is larger than the normal OSD.

Way 2: Exiting the advanced menu

- Turn off and restart your display in the normal way.

To make an adjustment, ensure the tag is highlighted, then press SELECT.

To move to another tag, press MENU, then press the left or right button to highlight another tag.

Tag1	PICTURE MODE	Sets PICTURE MODE PRESET, 1 to 5.
	PRESET	Selects PICTURE MODE.
	BRIGHTNESS	Adjusts the overall image and screen background brightness.
	WHITE	Adjusts the white color by temperature or xy setting. A lower color temperature will make the screen reddish and a higher color temperature will make the screen bluish. A stronger x makes the screen reddish, a stronger y makes it greenish and weak xy makes it a bluish white.

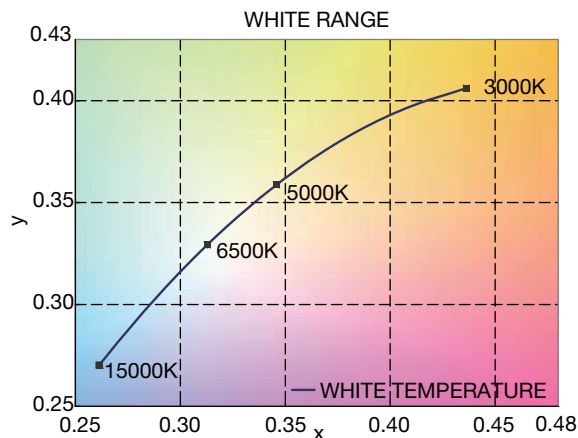

Tag1
(cont.)

GAMMA

Allows you to manually select the brightness level of grayscale. There are four selections: sRGB, L Star, DICOM, and CUSTOM. We recommend you show grayscale image data on screen.

sRGB: GAMMA setting for sRGB.

L Star: GAMMA for Lab color space.

DICOM: DICOM GSDF (Grayscale Standard Display Function) is possible for medical imaging.

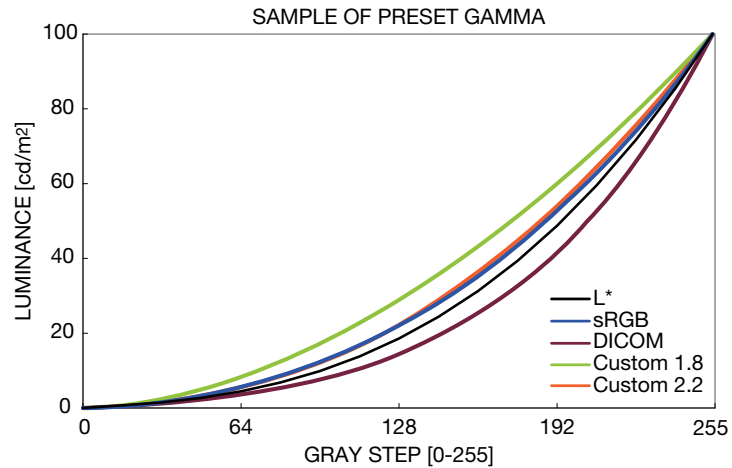

CUSTOM: Below items can be adjusted when CUSTOM is selected as the GAMMA SELECTION setting.

Custom Value: The gamma value is selected from the rate of 0.5 to 4.0 by 0.1 steps.

BLACK

Adjusts the black luminance. When low settings are selected that cannot be displayed, the indicator on the OSD will turn magenta.



Tag1
(cont.)

RED
GREEN
BLUE

Adjusts color gamut. Magenta warns of color saturation when outside of LCD gamut.

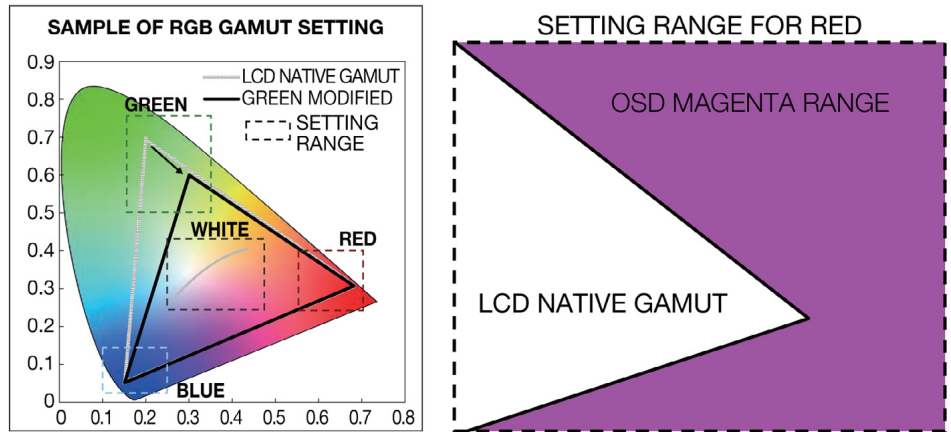

COLOR VISION EMU

Emulates color visions for difference color sense. P, D, T is for dicromats and Grayscale is for contrast regibility checking.

UNIFORMITY

This function electronically compensates for slight variations in the white uniformity level as well as for deviations in color that may occur throughout the display area of the screen. These variations are characteristic of LCD panel technology. This function improves the color and evens out the luminance uniformity of the display.

Note: Using the UNIFORMITY feature reduces the overall peak luminance of the display. If greater luminance is desired over the uniform performance of the display, then UNIFORMITY should be turned off. A higher number produces a better effect, but may also reduce contrast ratio. When BRIGHTNESS is shown in magenta, the UNIFORMITY setting is automatically changed.

Tag2

SHARPNESS

This is a digital capability for keeping a crisp image at all signal timings. It continuously adjusts to maintain as distinct or as soft an image as you prefer, and is set independently according to different timings.

RESPONSE IMPROVE

Turns the RESPONSE IMPROVE function on or off. Response improve may reduce blurring that occurs in some moving images.

ECO MODE

Decreases the amount of power consumed by reducing the brightness level. OFF: No function.

MODE1: Decreases the brightness up to 200 cd/m².

MODE2: Decreases the brightness up to 100 cd/m².





Tag2 (cont.)	METAMERISM	Improves color matching with other monitors. Mostly affects whites.
	6 - AXIS ADJUST HUE:	Adjusts the hue of each color ^{*1} . The change in color will appear on screen and the menu color bars will show the amount of adjustment. SATURATION: Adjusts the color depth of each color ^{*1} . Press the right button and the color vividness increases. OFFSET: Adjusts the color brightness of each color ^{*1} . Press the right button and the color brightness increases. ^{*1} RED, YELLOW, GREEN, CYAN, BLUE and MAGENTA.
	SHORTCUT CUSTOM	You can select the PICTURE MODE which is displayed in the PICTURE MODE shortcut menu.
Tag3	R-H.POSITION (analog input only)	Adjusts the position of the RED component of the image.
	G-H.POSITION (analog input only)	Adjusts the position of the GREEN component of the image.
	B-H.POSITION (analog input only)	Adjusts the position of the BLUE component of the image.
	R-FINE (analog input only)	Adjusts the FINE setting of the RED component of the image.
	G-FINE (analog input only)	Adjusts the FINE setting of the GREEN component of the image.
	B-FINE (analog input only)	Adjusts the FINE setting of the BLUE component of the image.



Tag3 (cont.)	R-SHARPNESS (analog input only)	Adjusts the sharpness of the RED component of the image.
	G-SHARPNESS (analog input only)	Adjusts the sharpness of the GREEN component of the image.
	B-SHARPNESS (analog input only)	Adjusts the sharpness of the BLUE component of the image.
	DVI LONG CABLE (DVI input only)	Compensates for image degradation caused by using a long DVI cable. There are 4 possible settings, with "0" being the lowest level of compensation and "3" being the highest level. The default setting is "1".

Tag4	AUTO ADJUST (analog input only)	Automatically adjusts the Image Position and H.SIZE settings and FINE settings. Press SELECT to activate auto adjustment. Use the test pattern, which is included with your Color Calibration Software.
	SIGNAL ADJUST (analog input only)	Determines when the auto adjustment is activated automatically. The choices are SIMPLE and FULL. Press the left or right buttons to select.

	H-size, Fine, H/V Position	Contrast
SIMPLE	O	X
FULL	O	O

O: Automatic Adjustment

X: No Automatic Adjustment

Note: Automatic Adjustment does not work at resolutions less than 800x600 resolution.

AUTO ADJUST LEVEL (analog input only)	Determines the automatic adjustment level for AUTO ADJUST. The choices are SIMPLE, FULL and DETAIL. Press the left or right buttons to select.
--	--

	Size, Fine, Position	Contrast	Black Level	Time
SIMPLE	O	X	X	1 second
FULL	O	O	X	1.5 seconds
DETAIL*	O	O	O	5 seconds

O: Automatic Adjustment

X: No Automatic Adjustment

* DETAIL activates automatic long cable (skew, peaking) adjustment.



Tag4 (cont.)	A-NTAA SW (analog input only)	<p>The Advanced No Touch Auto Adjust function is able to recognize new signals even when neither the resolution nor the refresh rate has changed. If several PCs are connected to the monitor, and each transmit very similar (or even the same) signals in terms of resolution and refresh rates, the monitor recognizes there is a new signal and automatically optimizes the picture without the need for any action on your part.</p> <p>OFF: A-NTAA is disabled.</p> <p>ON: If a change in signal is detected, A-NTAA will adjust the monitor to the optimal settings for the new signal. If no change in the signal is detected then A-NTAA does not activate. The screen will be blank while the monitor optimizes the signal.</p> <p>OPTION: Functions the same as ON, except that the screen does not go blank when the monitor makes adjustments for changes in signal, allowing the monitor to display the new signal faster. When using an external switching device to connect 2 or more PCs to the monitor, using the ON or OPTION settings is suitable.</p>
	AUTO CONTRAST (analog input only)	Adjusts the image displayed for non-standard video inputs. Press SELECT to adjust. Any adjustment requires the image to have white portions.
	CONTRAST	Adjusts the image brightness and contrast in relation to the background.
	AUTO BLACK LEVEL (analog input only)	Automatically adjusts the black level. Any adjustment requires the image to have black portions. Press SELECT to activate AUTO ADJUST.
	BLACK LEVEL (analog input only)	Adjusts the RGB black level by input signal level.
Tag5	H.POSITION	Controls Horizontal Image Position within the display area of the LCD.
	V.POSITION	Controls Vertical Image Position within the display area of the LCD.
	H.SIZE (analog input only)	<p>Adjusts the horizontal size of the screen.</p> <p>If the AUTO ADJUST function does not give you a satisfactory picture setting, a further tuning can be performed using the H.SIZE (V.SIZE) function (dot clock). For this a moiré test pattern may be used. This function may alter the width of the picture. Use left/Right Menu to center the image on the screen. The image should be homogeneous.</p>
	FINE (analog input only)	<p>Improve focus, clarity and image stability by increasing or decreasing this setting. If the AUTO ADJUST function and the H.SIZE function do not give you a satisfactory picture setting, a fine tuning can be performed using the FINE function. For this a moiré test pattern may be used. The image should be homogeneous.</p>
	AUTO FINE (analog input only)	This function automatically and periodically adjusts the FINE setting for change in signal condition. This function adjusts approximately every 33 minutes.
	H.RESOLUTION	Adjusts the horizontal size by increasing or decreasing the setting. Press the right button to expand the width of the image on the screen. Press the left button to narrow the width of the image on the screen.





Tag5 (cont.)	V.RESOLUTION	Adjusts the vertical size by increasing or decreasing the setting. Press the right button to expand the height of the image on the screen. Press the left button to narrow the height of the image on the screen.
	EXPANSION	Sets the zoom method. FULL: The image is expanded to full screen regardless of the resolution. ASPECT: The image is expanded without changing the aspect ratio. OFF: The image is not expanded. CUSTOM: When CUSTOM is selected as the expansion mode, it becomes possible to adjust the H. ZOOM., V. ZOOM, and ZOOM POS.
	SIDE BORDER COLOR	Adjusts the side black bars color between black and white.
Tag6	DVI SELECTION	Allows you to choose an appropriate mode for the video connection in use: DIGITAL, ANALOG, or AUTO.
	EDID EXTENSION (digital input only)	A communication setting with input device, containing signal timing. NORMAL: When a PC or other computer equipment is connected, select "Normal". Enhanced: Alternate setting for non-PC devices such as DVD players or game consoles. Note: Interlaced signals (480i, 576i, 1080i) are not supported. If you have any problems, see Troubleshooting . When EDID EXTENSION has been changed, the connected equipment has to be restarted.
	VIDEO DETECT	Selects the method of video detection when more than one computer is connected. FIRST: When current video input signal is not present, then the display searches for a video signal from the other video input port. If the video signal is present in the other port, then the display switches the video source input port to the new found video source automatically. The display will not look for other video signals while the current video source is present. LAST: When the display is showing a signal from the current source and a new secondary source is supplied to the display, then the display will automatically switch to the new video source. When current video input signal is not present, then the display searches for a video signal from the other video input port. If the video signal is present in the other port, then the display switches the video source input port to the new found video source automatically. NONE: The display will not search the other video input port unless the display is turned on.
	OFF TIMER	Display will automatically turn off after the preset time period from power on with the ON/OFF function. When you select "On", press SELECT and the left or right button to adjust. Before powering off, a message will appear on the screen asking if you want to delay the turn off time by 60 minutes. Press any OSD button to delay the turn off time.





Tag6 (cont.)	OFF MODE	The Intelligent Power Manager allows the display to enter into a power saving mode after a period of inactivity. The OFF MODE has three settings. OFF: Display does not go into power save mode when the input signal is lost. STANDARD: Display enters power save mode automatically when the input signal is lost.
	LED BRIGHTNESS	Controls the brightness of the power LED on the display.
	FAN CONTROL	Enables you to set the fan speed.
Tag7	LANGUAGE	OSD control menus are available in eight languages.
	OSD H.POSITION	You can choose where you would like the OSD control image to appear on your screen. Selecting OSD Location allows you to manually adjust the position of the OSD control menu left or right.
	OSD V.POSITION	You can choose where you would like the OSD control image to appear on your screen. Selecting OSD Location allows you to manually adjust the position of the OSD control menu up or down.
	OSD TURN OFF	The OSD control menu will stay on as long as it is use. You can select how long the display waits after the last touch of a button to shut off the OSD control menu. The preset choices are 10-120 seconds by 5 second steps.
	OSD LOCK OUT	This control completely locks out access to all OSD control functions. When attempting to activate OSD controls while in the Lock Out mode, a screen will appear indicating the OSD controls are locked out. There are three types of OSD LOCK OUT: OSD LOCK OUT with no control: To activate the OSD LOCK OUT function, press SELECT, then right button and hold down simultaneously. To deactivate the OSD LOCK OUT, press SELECT, then right button and hold down simultaneously while in the OSD menu. No controls can be adjusted while in the lock out mode. OSD LOCK OUT with BRIGHTNESS (only) control: To activate the OSD LOCK OUT function, press SELECT, then the down and left buttons and hold down simultaneously. To deactivate the OSD LOCK OUT, press SELECT, then the down and left buttons and hold down simultaneously while in the OSD menu. BRIGHTNESS can be adjusted while in the lock out mode. CUSTOM: Press RESET and MENU to enter the CUSTOM Menu. Select ENABLE or DISABLE for POWER KEY, INPUT SEL, HOT KEY (BRIGHTNESS), PICTURE MODE, WARNING (RESOLUTION NOTIFIER/OSD LOCK OUT). To Deactivate the OSD LOCK OUT function, press RESET and MENU to bring up the LOCK OUT warning. Press SELECT, SELECT, <, >, <, >, MENU.



Tag7 (cont.)	OSD TRANSPARENCY	Adjusts the transparency of the OSD menu.
	SIGNAL INFORMATION	Signal information can be displayed in the corner of the screen. SIGNAL INFORMATION is either On/Off.
	RESOLUTION NOTIFIER	The optimal resolution is 1920 x 1200. If ON is selected, a message will appear on the screen after 30 seconds, notifying you that the resolution is not set to 1920 x 1200.
	HOT KEY	When this function is activated, the brightness of the display can be adjusted without entering the OSD menu by using the front buttons. The left or right buttons adjust the brightness level. When this function is set to OFF, some buttons are disabled.
	FACTORY PRESET	Selecting FACTORY PRESET allows you to reset all OSD control settings back to the factory settings. Highlighting the control to be reset and pressing the RESET button can reset individual settings.
Tag8	PIP MODE	Selects PIP MODE, OFF/PIP/PICTURE BY PICTURE - ASPECT/PICTURE BY PICTURE - FULL.
	PIP INPUT	Selects the PIP input signal.
	PIP LEFT/RIGHT	When you select "PIP" in PIP MODE, you can control the horizontal position of the PIP display area.
	PIP DOWN/UP	When you select "PIP" in PIP MODE, you can control the vertical position of the PIP display area.
	PIP SIZE	Selects the size of the sub-picture used in PIP MODE.
	BLANK SIGNAL SKIP	Skip no signal inputs when you change input signal with SELECT button.
	OSD ROTATION	LANDSCAPE: Display the OSD with landscape mode. PORTRAIT: Display the OSD with portrait mode.
	MAIN IMAGE ROTATION	OFF: The display image is not rotated. IMAGE ROTATION is set to OFF by default. ON: The display image is always rotated.
	SUB IMAGE ROTATION	Available when using PIP mode. Allows rotation of the PIP sub-image. OFF: The PIP image is not rotated. SUB IMAGE ROTATION is set to OFF by default. ON: The PIP image is always rotated.





Tag8 (cont.)	DDC/CI	DDC/CI ENABLE/DISABLE: Turns on or off the two-way communication and control with the connected PC by video cable.
	SCREEN SAVER	<p>Use the SCREEN SAVER to reduce the risk of image persistence.</p> <p>MOTION (default OFF): Screen image moves periodically in 4 directions in order to reduce the risk of image retention. Timing for MOTION can be set so the screen image moves in intervals from every 10 to 900 seconds. Timing is set in 10-second increments.</p> <p>OPTION (default REDUCED): There are two optional selections.</p> <p>REDUCED: Screen image is reduced to 95% size and is moved periodically in 4 directions. Screen may appear slightly less sharp than normal. The full image appears on the display.</p> <p>Note: Some input signals may not be supported by REDUCED.</p> <p>FULL: Screen image is set to FULL and is moved periodically in 4 directions. Screen image goes outside of the display area in the direction that it shifts so that a portion of the image may appear to be cut off.</p>
Tag9	INPUT SETTING	<p>Video Band Width (analog input only): Reduce the visual “noise” level of the input signal.</p> <p>Sync Threshold (analog input only): Adjusts the slice level of a synchronization signal. Press SELECT to move the adjustment menu. Adjusts the sensitivity of the separate or composite input signals. Try this option if the FINE adjustment does not successfully eliminate the noise.</p> <p>SOG Threshold (analog input only): Adjusts the sensitivity of the Sync On Green input signals. Adjusts the slice level when separating synchronization from Sync On Green signal input.</p> <p>Clamp position: Operating your monitor at a non-standard timing may cause images to appear darker than normal or have color distortion. Use of the Clamp position control will adjust images to their normal state.</p>
TagA	CARBON SAVING	Displays the estimated carbon savings information in kg.
	COST	Displays the electricity cost savings in balance.
	CARBON CONVERT SETTING	Adjusts the carbon footprint factor in the carbon savings calculation. This initial setting is based on the OECD (2008 Edition).
	CURRENCY SETTING	Displays electricity pricing (available in 6 currency units).
	CURRENCY CONVERT SETTING	Adjusts electricity prices-electric energy equivalent in the electrical rate savings calculation.
	HOURS RUNNING	Shows total running time.
TagB	INFORMATION	Provides information about the current display resolution Technical data, including the preset timing currently being used. The horizontal and vertical frequencies are also displayed.



OSD CONTROLS, CINTIQ 24HD



Menu options are available when you open the On Screen Display.

LANGUAGE options allow you to choose the language in which to display the OSD menu.

OSD POSITION options include:

- VERTICAL. Adjusts the vertical position of the OSD menu window.
- HORIZONTAL. Adjusts the horizontal position of the OSD menu window.
- TRANSPARENCY. Changes the opaqueness of the OSD menu background.

DISPLAY options include:

- CONTRAST. Increases or decreases image contrast. Changes in contrast may affect color accuracy.
- BRIGHTNESS. Increases or decreases the image brightness.
- BACKLIGHT. Increases or decreases the backlight brightness level.

COLOR options include:

- 5000K, 6500K, 9300K. Enables you to adjust the pen display color temperature, in degrees Kelvin.
- DIRECT displays the colors directly from the video card without any adjustment. When selected, contrast or brightness cannot be adjusted.
- CUSTOM enables you to independently adjust the RED, GREEN, and BLUE display colors.
Any changes you manually make to the color settings will override the color profile settings.

SCALING options include:

- FULL. Resizes the image to fill the whole screen.
- ASPECT. Resizes the image to fill as much of the screen as possible while maintaining the correct aspect ratio.
- 1:1. Displays the image at the actual resolution.



OTHER options include:

- PHASE. (VGA only.) Synchronizes the signal timing of the pen display to that of your graphics card. Use when you experience an unstable or flickering image, or horizontal distortion lines.
- PITCH. (VGA only.) Changes the display data frequency to match that of your graphics card. Use when you experience an unstable or flickering image, or vertical distortion lines.
- VERTICAL. (VGA only.) Changes the vertical position of the image. To automatically adjust, use the AUTO ADJUST option.
- HORIZONTAL. (VGA only.) Changes the horizontal position of the image. To automatically adjust, use the AUTO ADJUST option.
- AUTO ADJUST. (VGA only.) Choose this function to automatically optimize the display screen image.

RESET returns the display parameters of the current mode to their factory default settings.

EXIT dismisses the OSD without making changes.



POWER SAVING

Cintiq conforms to VESA power saving guidelines.

When used with a Display Power Management Signaling (DPMS) compliant computer or video card, the display will automatically comply with the power saving parameters shown below.

When power-saving functions are in effect, the screen display is darker than usual.

COMPUTER MODE	H-SYNC	V-SYNC	VIDEO	POWER LED
Power ON	Yes	Yes	Active	Blue
Standby mode	No	Yes	Blanked	Orange
Suspend mode	Yes	No	Blanked	Orange
OFF mode	No	No	Blanked	Off



THE MULTI-TOUCH EXPERIENCE WITH CINTIQ



The Cintiq 24HD interactive pen display is designed to enhance the way you work. Multi-touch enables you to interact with a computer using only your fingertips on the Cintiq display screen surface.

You can use touch on Cintiq as you would on any other Mac or Windows device, such as phones, trackpads, and notebooks. First learn the basic actions to navigate and perform typical mouse operations. Then learn how to scroll, zoom, and rotate.

Touch is activated whenever you touch the display screen surface.

- When using touch, you can generally position your fingers as far apart as is comfortable. However, placing your fingers too closely together may be interpreted by Cintiq as input from a single finger, or Cintiq may confuse which finger initiated or performed an action or gesture. Your fingers must remain within the active area of the screen surface.
- Experiment with touch to see what works best for you. Take care to prevent accidental touches on the display screen when making gestures. For example, if your small finger touches the display screen surface when zooming or scrolling, then you may trigger an unanticipated right-click.

Note: For product models that support both pen and multi-touch, you can simultaneously work with the pen and touch in supporting applications. For example, you might use touch to turn a 3D object while using the pen to sculpt a surface texture. The pen has priority over touch whenever the pen tip or eraser is within proximity of the pen display screen. Lift the pen and your hand away from the display screen surface to enable touch.

[Navigating with multi-touch](#)

[Customizing multi-touch](#)

[Testing multi-touch](#)

NAVIGATING WITH MULTI-TOUCH



The multi-touch feature of your Cintiq interactive pen display enables you to control a computer using only your fingertips on the display screen surface.

Touch options can be individually enabled or disabled within the Wacom Tablet control panel. Touch is on when selected in the TOUCH OPTIONS, STANDARD GESTURES, or MY GESTURES tab.

- Use basic actions to navigate and perform typical mouse operations.
- Use gestures to scroll, zoom, rotate, and perform other functions.

Uncheck to disable touch.

Touch can be completely disabled (and again enabled) from any of the touch function tabs in the Wacom Tablet control panel.

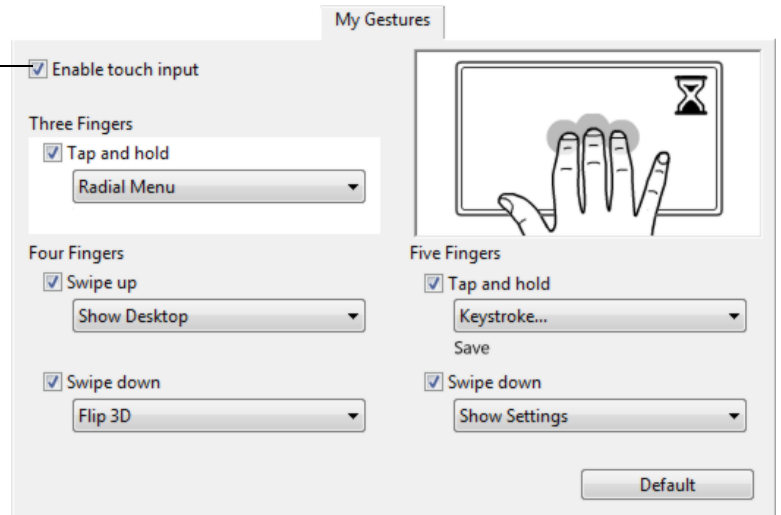

My GESTURES tab shown.

Windows screen capture shown. Available options may vary, depending on your operating system and version.

Windows: This tab is visible only after you select the USE WACOM GESTURES option in the TOUCH OPTIONS tab.

You can [customize your touch experience](#) and also [customize the ExpressKeys](#) to perform some touch functions.



Note: In the following descriptions, two-finger actions and gestures apply primarily to Mac.

Although some gestures may be similar, Windows systems use the Windows standard two-finger gestures by default. For a consistent experience across applications, select the USE WACOM gestures option in the Wacom Tablet control panel TOUCH OPTIONS tab.

BASIC FUNCTIONS

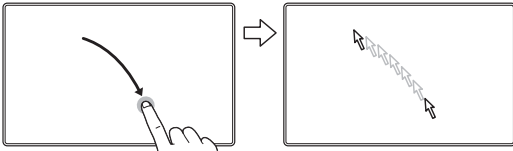

Navigate. Use a single finger to position the screen cursor. The screen cursor jumps to the position where you touch the display screen surface.

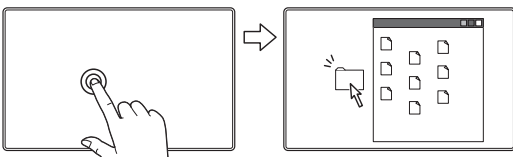

Double-click. Using a single finger, tap twice on an item.

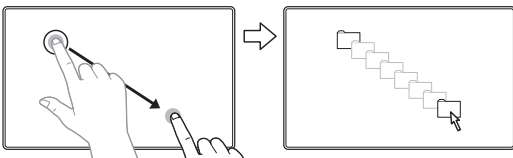

Drag. Using a single finger, select an item. Move your finger across the display screen surface to drag your selection. Lift your finger to release the item.

Tip:

You can select and drag multiple items on the system desktop:

Windows: Press the CTRL or SHIFT key as you tap to select multiple items.

Mac: Press the SHIFT or COMMAND key as you tap to select multiple items.

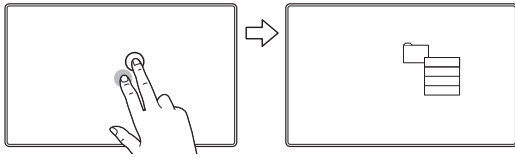

**ADD TAP TO RIGHT CLICK**

Using a single finger, select an item. Then with a second finger touch and release to the right of that finger. Releasing your finger issues a right-click and brings up a context menu at the screen cursor position.

You can then select an option in the menu with the touch of a finger.

Note: If Cintiq is configured for left-handed use, touch to the left of the primary finger.

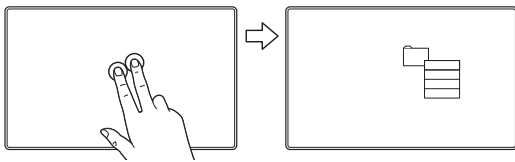
**TAP TO RIGHT CLICK**

To right-click and bring up a context menu at the screen cursor position, tap the display screen surface with two fingers spaced slightly apart.

You can then select an option in the menu with the touch of a finger.

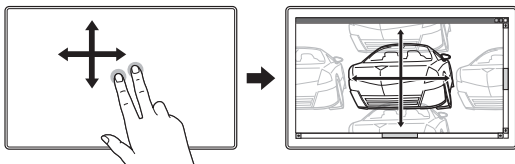
APPLICATION-SPECIFIC FUNCTIONS**SCROLL**

Place two fingers on the display screen surface. Using a smooth motion, move your fingers together in parallel.

- Scroll up by moving your fingers in an upward motion.
- Scroll down by moving your fingers in a downward motion.
- Scroll left by moving your fingers in a leftward motion.
- Scroll right by moving your fingers in a rightward motion.

Fast scroll. Quickly move (or flick) two fingers together, lifting your fingers at the end of the motion.

- Fast scroll up by flicking your fingers in an upward motion.
- Fast scroll down by flicking your fingers in a downward motion.

Note: Fast scrolling works only for vertical scrolling.

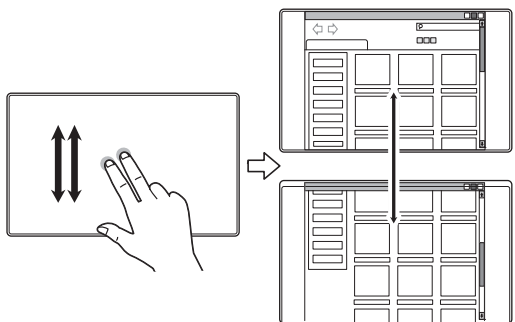

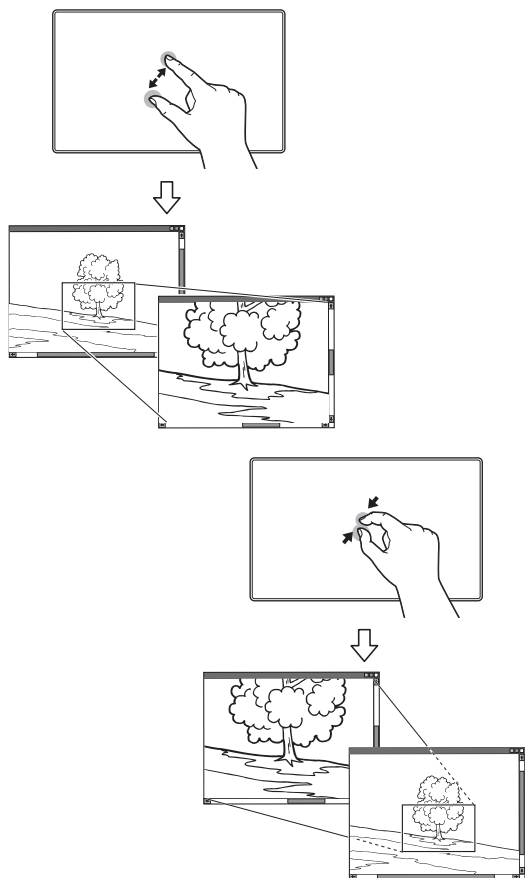

ZOOM

First place two fingers on the display screen surface.

- Zoom-in by moving (expanding) your fingers away from one another.
- Zoom-out by moving (pinching) your fingers toward one another.

Note: If zoom functions do not operate correctly within Adobe® Photoshop®, verify that the ZOOM WITH SCROLL WHEEL function is not selected within the Photoshop PREFERENCES options.

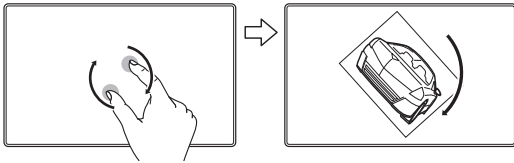

**ROTATE**

Two finger rotate. Place two fingers diagonally on the display screen surface and then rotate them clockwise or counter-clockwise.

For best recognition of this gesture, start with your fingers positioned diagonally on the display screen and keep them at least 25 mm (1 inch) apart.

Note: The rotate gesture may work differently depending on the application you are working with. Rotation may work smoothly, in 90-degree increments, or not at all.

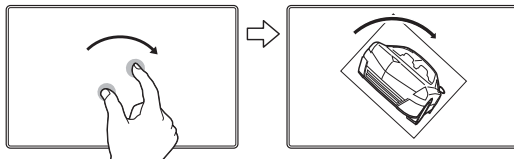

Rotate around finger. Place two fingers diagonally on the display screen surface. Keep one finger stationary and move the other finger around it.

For best recognition of this gesture, start with your fingers positioned diagonally on the display screen and keep them at least 25 mm (1 inch) apart.

Note: The rotate gesture may work differently depending on the application you are working with. Rotation may work smoothly, in 90-degree increments, or not at all.

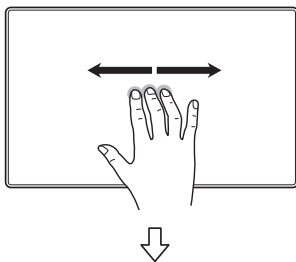
**SWIPE LEFT/RIGHT TO NAVIGATE**

Forward or Back (swipe right or left). Swipe using three fingers spaced slightly apart, lifting your fingers at the end of the motion.

- Send a 'Forward' command in most browsers and picture viewers by swiping to the right.
- Send a 'Back' command in most browsers and picture viewers by swiping to the left.

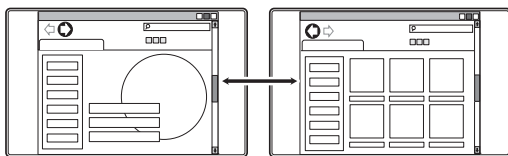
**Tips:**

- Swiping is similar to using the right and left arrow keys in document viewers.
- Use the swipe gestures to page forward or back in most web browsers.



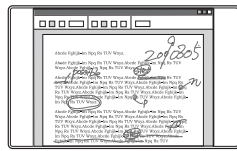

SWIPE LEFT/RIGHT TO SWITCH APPLICATIONS

Using four fingers spaced slightly apart, move your fingers left or right to open the application switcher. Then use a single finger to select an application.

Mac OS 10.7.x. Using four fingers, swipe them left or right to switch between full-screen apps.

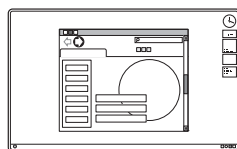
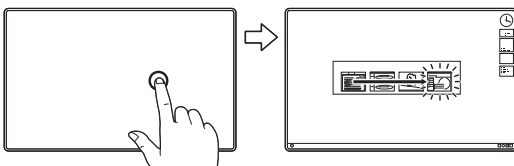
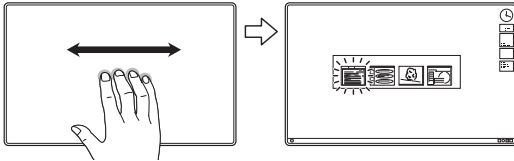

SWIPE UP to SHOW DESKTOP

Using four fingers spaced slightly apart, swipe up to show the desktop. Swipe up again to move your open windows back to the desktop.

Mac OS 10.7.x. Swipe up for Mission Control and view all of the open windows on your Mac. Swipe up again to exit Mission Control.

This gesture can be customized. See [choosing custom multi-touch functions](#).

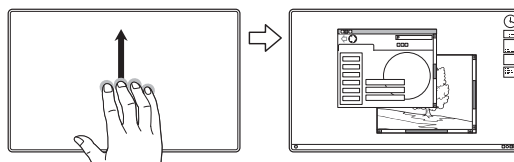
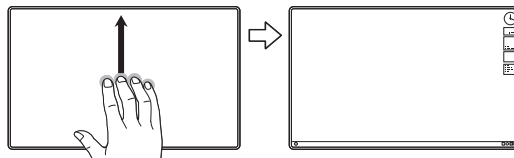

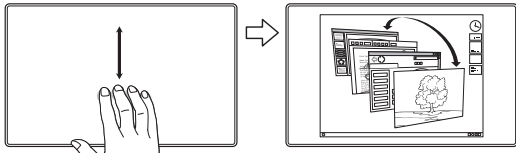

SWIPE DOWN for FLIP 3D/EXPOSÉ/APP EXPOSÉ

Using four fingers spaced slightly apart, swipe down.

- **Flip 3D (Windows):** Your first swipe opens Flip 3D. Swipe down again to close Flip 3D. Swipe left or right to move through the open windows. Use a single finger tap to select.
- **Exposé (Mac):** Your first swipe opens Exposé. Swipe down again to close Exposé. Use a single finger tap to select.
- **App Exposé (Mac OS 10.7.x):** Swipe down to preview the open windows of the app you are working with. Swipe down again to exit App Exposé.

This gesture can be customized. See [choosing custom multi-touch functions](#).

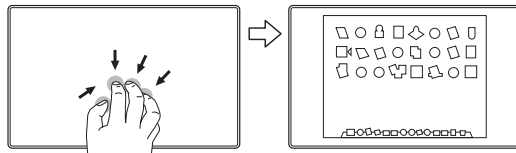
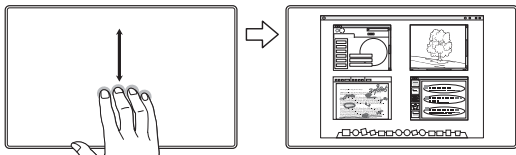

PINCH FOR LAUNCHPAD

Mac OS 10.7.x only. Place your thumb and three fingers on the display screen surface, then pinch them together to fade your open windows and display all of your apps.

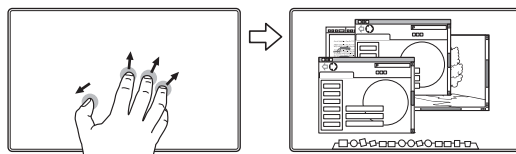

SPREAD TO SHOW DESKTOP

Mac OS 10.7.x only. Place your thumb and three fingers on the display screen surface, then spread them apart to show the desktop view.

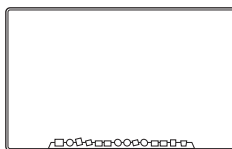

WACOM-SPECIFIC FUNCTIONS

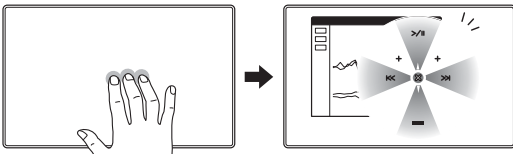

TAP to display RADIAL MENU

Using three fingers spaced slightly apart, tap them on the display screen surface. This action will open the [Radial Menu](#).

This gesture can be customized. See [choosing custom multi-touch functions](#).

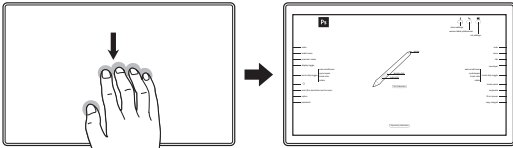
SWIPE DOWN to show [SETTINGS](#)

Using five fingers spaced slightly apart, swipe down to activate (on your display screen) an interactive diagram of the current ExpressKey, Touch Ring, and pen settings.

Click on a section of the diagram to open the appropriate Wacom Tablet control panel tab. You can then adjust settings as needed.

Swipe down again to dismiss the diagram, or click anywhere outside of the diagram.

This gesture can be customized. See [choosing custom multi-touch functions](#).

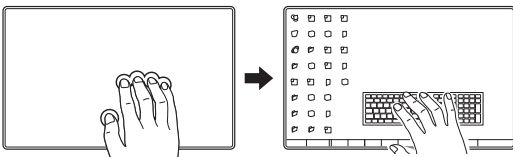

TAP to show ON-SCREEN KEYBOARD

Using five fingers spaced slightly apart, tap them on the display screen surface. This action will launch the on-screen keyboard.

Close the keyboard by again tapping five fingers on the display screen surface.

This gesture can be customized. See [choosing custom multi-touch functions](#).



CUSTOMIZING MULTI-TOUCH



Use the Wacom Tablet control panel to customize your product for the way you like to interact with multi-touch on your Cintiq and computer. Select the TOUCH icon in the TOOL list. Then select an appropriate tab to customize, and change settings using the available options. See also [navigating with multi-touch](#).

[Manage your control panel settings](#)

[Control panel overview](#)

[Setting multi-touch options](#)

[Choosing standard multi-touch functions](#)

[Choosing custom multi-touch functions](#)

[Application-specific settings](#)

[Disabling multi-touch](#)



SETTING MULTI-TOUCH OPTIONS



Select the TOUCH OPTIONS tab.

For Windows 7 or later, only.

Choose an option to use Windows standard gestures or Wacom gestures. The default is to use Windows gestures.

This is a global option and will apply to all of your applications.

Tip: Choose USE WACOM GESTURES for a consistent experience across applications. When selected, all Windows standard gestures are available, as well as the customizable gestures shown on the MY GESTURES tab of the Wacom Tablet control panel.

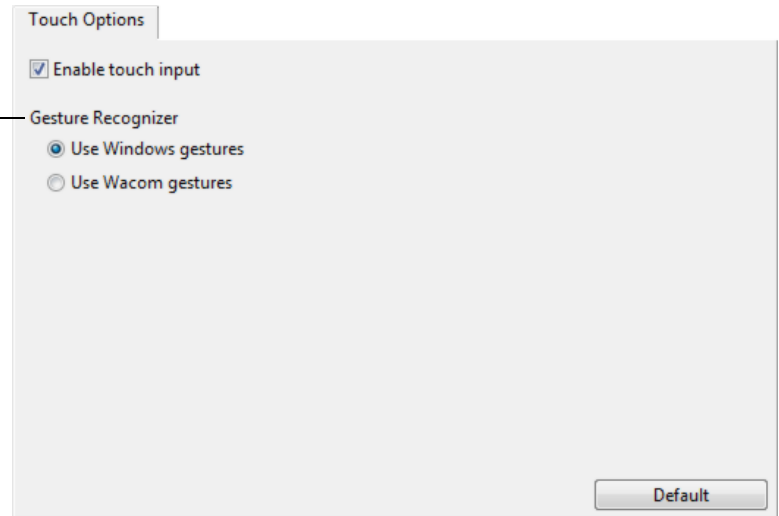

DOUBLE-TAP TIME adjusts how fast you must tap to register a double-click. To test your setting, tap twice on the TEST area. Not available for Windows.

Note: The DOUBLE-TAP TIME setting is independent of system settings. Changes you make to this setting in the Wacom Tablet control panel do not affect similar system settings. However, changes made to similar system settings may affect your Cintiq setting.

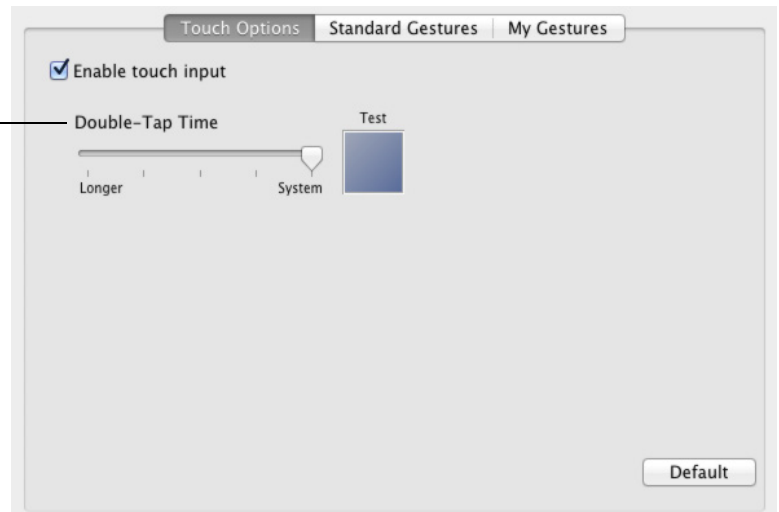

Mac screen capture shown.

CHOOSING STANDARD MULTI-TOUCH FUNCTIONS



To customize Cintiq for your touch preferences, select the STANDARD GESTURES tab.

Note: This tab is not available for Windows systems. The Windows standard two-finger actions and gestures are always available.

[Multi-touch](#) actions and gestures are available when selected.

So that you may work in different ways, some functions (such as a right-click) can be performed using different actions or gestures.

Position the screen cursor over a touch option to see a static image of that function.

If you do not choose a specific option to view, then the control panel will display each option sequentially, from top to bottom.

See also [navigating with multi-touch](#) and [choosing custom multi-touch functions](#).

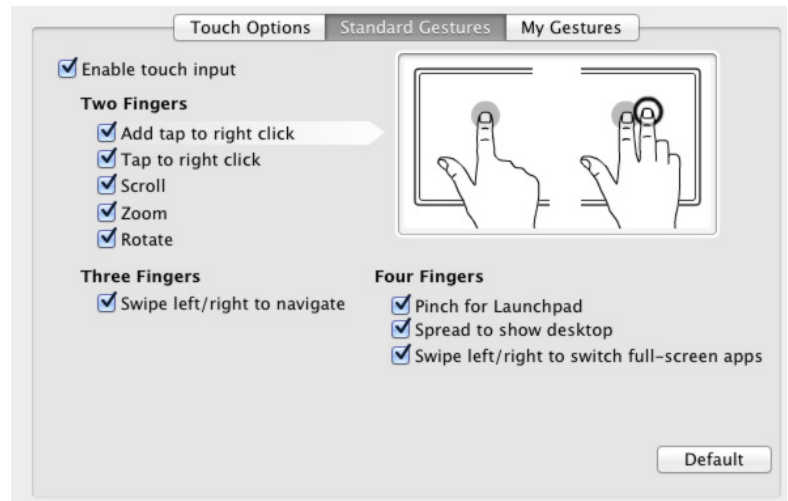

Mac screen capture shown. Available options may vary, depending on your operating system and version.

CHOOSING CUSTOM MULTI-TOUCH FUNCTIONS



To create custom touch gestures, select the MY GESTURES tab.

[Multi-touch](#) gestures are modified based on your selection from the drop-down menus, and are available when selected.

Position the screen cursor over a touch option to see a static image of that function.

If you do not choose a specific option to view, then the control panel will display each option sequentially, from top to bottom.

See also [navigating with multi-touch](#) and [choosing standard multi-touch functions](#).

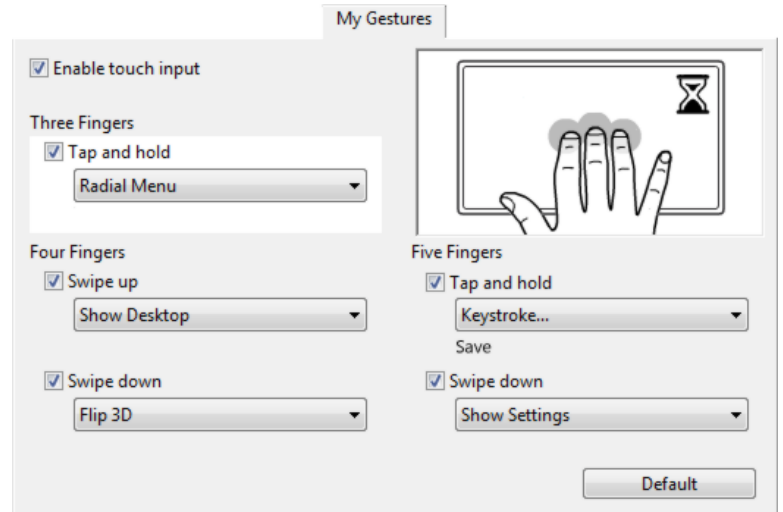

Windows screen capture shown. Available options may vary, depending on your operating system and version.

Windows: This tab is visible only after you select the USE WACOM GESTURES option in the TOUCH OPTIONS tab.

DISABLING MULTI-TOUCH



Choose the STANDARD GESTURES, MY GESTURES, or TOUCH OPTIONS tab to disable and enable touch.

- Deselect to disable multi-touch. You can still work with the ExpressKeys and pen.
- Select to ENABLE TOUCH.
- This option can also be changed by pressing an ExpressKey to which the TOUCH ON/OFF function has been assigned.

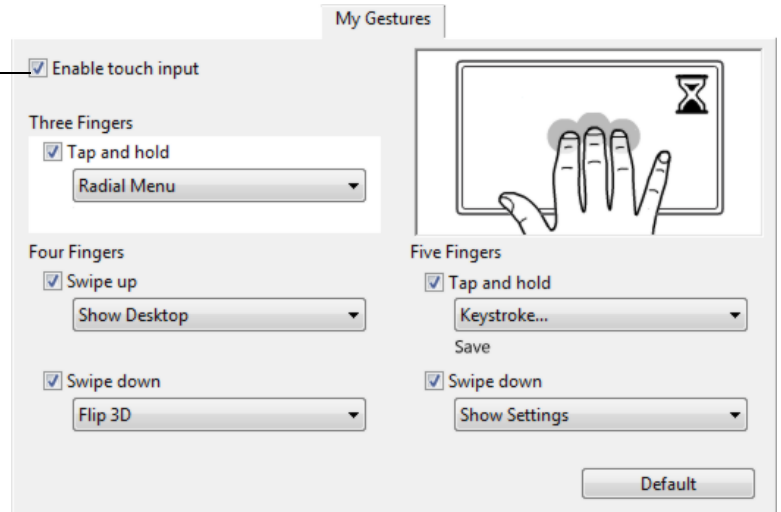

MY GESTURES tab shown.

Press an ExpressKey or other tool button configured for the [SETTINGS](#) option to display an interactive diagram of the current Cintiq settings on your display screen.

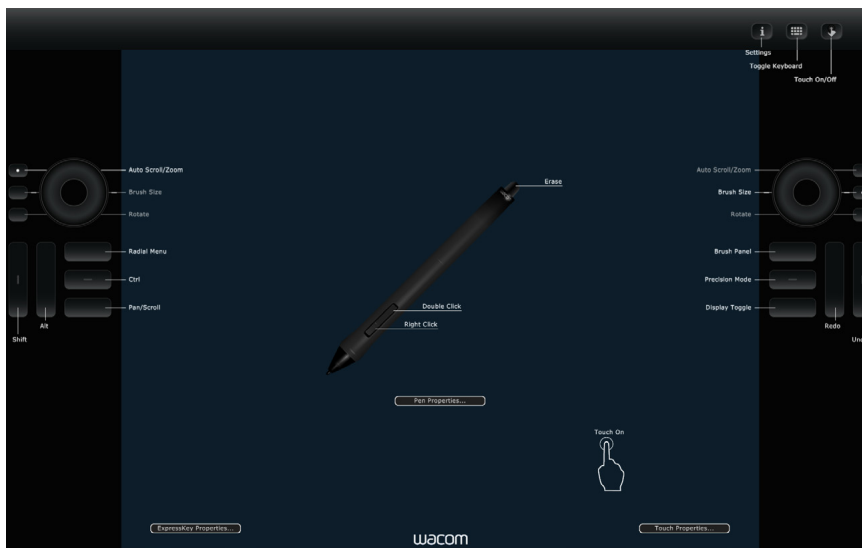

Click TOUCH PROPERTIES... to access your touch settings in the Wacom Tablet control panel.

TESTING MULTI-TOUCH



If you encounter problems with multi-touch, it is a good idea to first check the assigned touch functions or reset them to their default conditions.

To further test touch:

1. Attempt to move the screen cursor by touching your finger in different places on the display screen surface. Touch to select an item. The status LED should brighten when you touch the display screen surface. See also [testing Cintiq](#).
2. Open the Wacom Tablet control panel and click on the ABOUT button. In the dialog box that appears, click DIAGNOSE.... The DIAGNOSTICS dialog box shows dynamic information about Cintiq, your Cintiq tool(s), and appropriate information for touch-sensitive product models. See also [testing controls and input tools](#).
3. With the DIAGNOSTICS dialog box open, touch the display screen surface with first one, then with two fingers. Each time you touch the display screen surface, the tablet status LED should brighten and the TOUCH INFO state should change.
4. When you are done, click the CLOSE button to exit the dialog box.



CUSTOMIZING YOUR CINTIQ

After mastering the basics of using your pen and Cintiq 24HD interactive pen display, you may want to customize the way Cintiq works. This chapter describes how to adjust your pen display and input tool settings.

Advanced users can learn how to further optimize Cintiq by creating [application-specific settings](#).

[Manage your control panel settings](#)

[Control panel overview](#)

[Calibrating the pen display](#)

[Customizing the pen](#)

[Customizing multi-touch](#)

[Customizing pen display functions](#)

[Button functions](#)

[Using and customizing the Radial Menu](#)

[Working with Display Toggle](#)

[Application-specific settings](#)

[Working with multiple tools](#)

[Renaming the tablet in the tablet list](#)



MANAGE YOUR CONTROL PANEL SETTINGS

Open the Wacom Tablet control panel using the pen on the pen display:

- **Windows.** Click on the Windows START button and choose ALL PROGRAMS. Then select WACOM TABLET and choose the WACOM TABLET PROPERTIES option.
- **Mac.** Open SYSTEM PREFERENCES from either the Dock, the Apple menu, or from the APPLICATIONS folder. Then click on the WACOM TABLET icon.

You can begin customizing Cintiq after opening the control panel. See [control panel overview](#).

Note: User-specific preferences are supported. After logging on, each user can customize their personal settings in the Wacom Tablet control panel. Switching to another user will automatically load the settings for that user.

Tips:

- Display an interactive diagram of the current pen display settings by pressing the appropriate [hardware control button](#) at the top of the pen display.

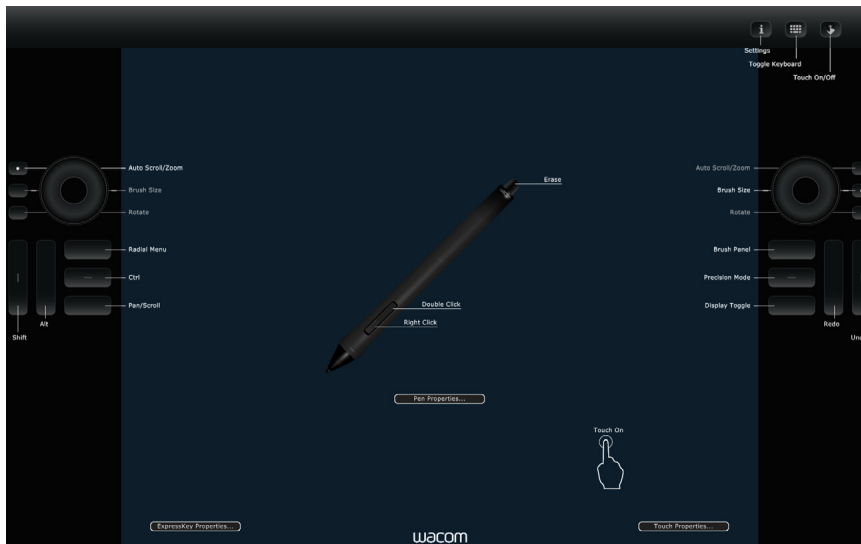

Click on any section of the diagram to open the appropriate Wacom Tablet control panel tab. Settings may vary depending on your product model.

- **Cintiq 24HD:** Launch the Wacom Tablet control panel by pressing the appropriate Cintiq [hardware control button](#).

CONTROL PANEL OVERVIEW

Use the Wacom Tablet control panel to customize your Cintiq or Grip Pen. When you open the control panel, an icon for the Grip Pen or other input tool is displayed in the TOOL list. A TOUCH icon is also displayed for product models that support multi-touch. The appropriate tabs are displayed.

To customize, make changes to the tab controls. Experiment with different settings to find what works best for you. Any changes you make will take effect immediately. Click DEFAULT to return to the factory settings.

Icons represent your pen display (TABLET), TOOL, and APPLICATION settings.

Choose FUNCTIONS to customize the ExpressKey, Touch Ring, and [Radial Menu](#) settings. [Display Toggle](#) options are available on multiple monitor systems.

For touch-sensitive models, choose TOUCH to customize your touch settings. See [customizing multi-touch](#).

Choose GRIP PEN to customize the pen settings. The icon is available after you have used a pen on the pen display.

Tabs display customizable settings for the selected TOOL.

Displays information dialog, and option to **DIAGNOSE...** your product.

Displays [advanced options](#).

Resets the selected tab to its default settings.

Downloads or displays this manual.

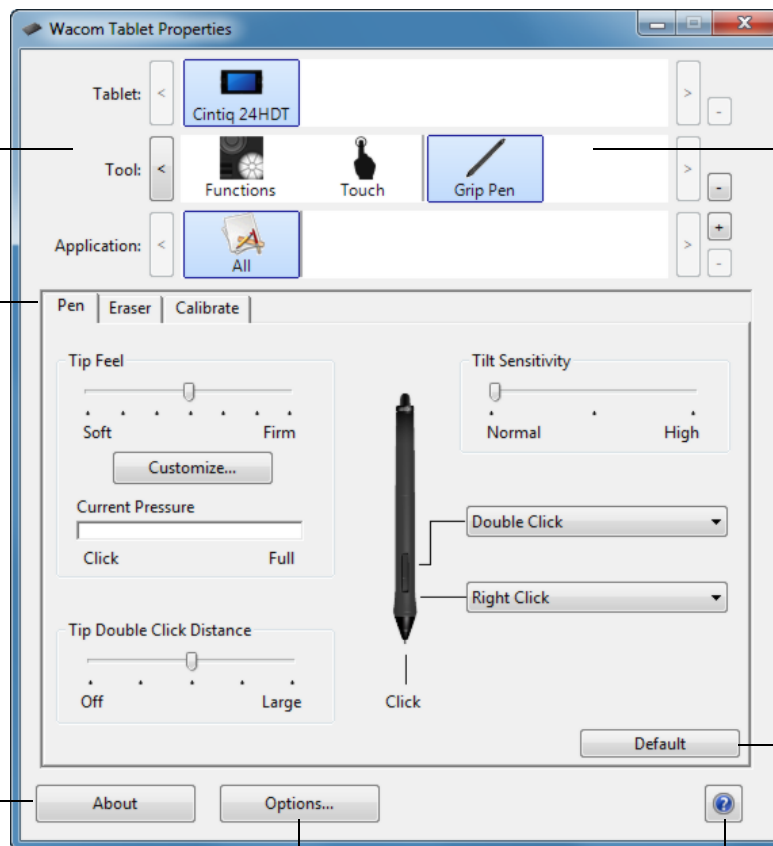

Tool Tips are available for most control panel items. Position the screen cursor over an item and let it rest there. The appropriate Tool Tip will pop up in a few moments.

Your keyboard tab and arrow keys can also be used to navigate the control panel.



Control panel lists and tabs: The control panel TABLET, TOOL, and APPLICATION lists allow you to select the pen display or tablet, tool, or application for which you want to change settings.

The TABLET list displays an icon for any supported pen display or tablet that has been installed on your system and is currently connected. All settings shown below the list apply to the selected pen display or tablet.

- The control panel will not launch unless a supported pen display or tablet is connected to the computer.
- Settings can only be viewed or changed for an attached pen display or tablet.
- A pen display or tablet cannot be deleted from the control panel list unless it is attached to the computer.

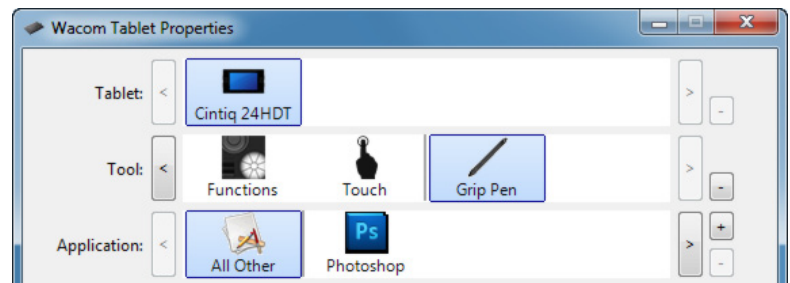

Current selections are highlighted.

See also [installing multiple tablets](#) and [renaming the tablet in the tablet list](#).

The TOOL list displays icons for the pen display FUNCTIONS and for the different tools that have been used on the pen display. The TOUCH icon is displayed for touch-sensitive models.

To customize settings for a tool, click on its icon within the TOOL list. The appropriate tabs will be displayed. See [customizing pen display functions](#), [customizing the pen](#), and [customizing multi-touch](#).

Note: The pen will be automatically added to the TOOL list when first used on the pen display, and functions using the default settings.

See also [working with multiple tools](#).

Use the APPLICATION list to define TOOL settings that apply only to a specific application. See [application-specific settings](#).

Note: The APPLICATION list is optional. It is not necessary to select or add applications in order to customize your Cintiq tool(s).

CALIBRATING THE PEN DISPLAY



For optimum performance, you must calibrate the pen display to align the screen cursor with the position of the pen on the display screen. This is required to compensate for viewing angle, and to adjust for [parallax](#). Set Cintiq in its working position, then follow the below procedure.

Important: If using a VGA connection, first **RESET** the pen display. See [On Screen Display \(OSD\) settings](#).

1. Open the Wacom Tablet control panel.
If more than one pen display is installed on your system, select the pen display you are working with from the TABLET list.
2. Select GRIP PEN from the TOOL list. Then select the CALIBRATE tab.
3. If you are working with multiple monitors, select the MONITOR corresponding to your Cintiq. Only monitors that are set to one of the resolutions supported by Cintiq will appear in the list.
4. Click CALIBRATE... to activate the calibration screen.
5. Hold the pen and position your head as you normally do when working with the pen display. Use the pen tip to click on the center of the crosshairs in the upper-left corner.
6. Then click on the center of the crosshairs that are displayed in the upper-right, lower left, and lower right corners.
7. Test the alignment by positioning the pen at a few different points on the display. Click OK to accept the calibration. Click TRY AGAIN to recalibrate.

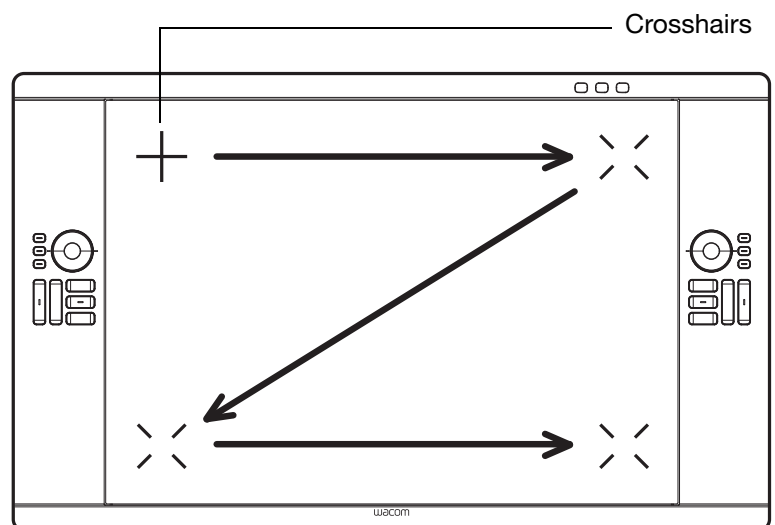

Tip: To see the screen cursor slightly offset from the actual position of the pen tip, calibrate by clicking on a spot showing that offset from the crosshairs. For example, to have the screen cursor appear 2.5 mm (1/10th of an inch) above and to the left of the pen tip, calibrate by clicking on a spot 2.5 mm (1/10th of an inch) below and to the right of the crosshairs.

CUSTOMIZING THE PEN



Use the pen when opening the Wacom Tablet control panel. The pen will be selected in the TOOL list and the appropriate tabs will be displayed. If not automatically selected, choose the pen from the TOOL list. Select a tab and choose from the available options.

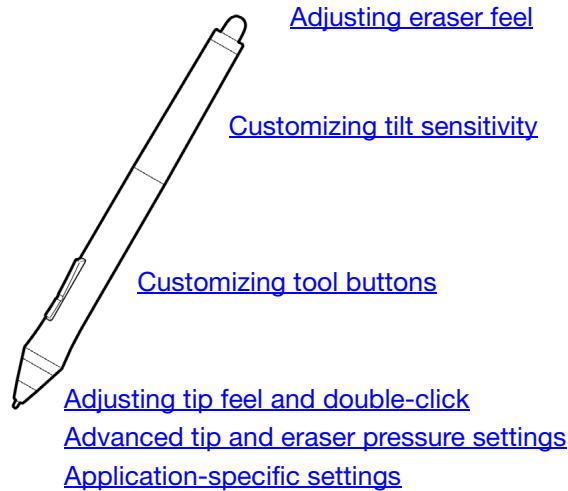

Wacom offers a number of optional pens, such as the Art Pen and Airbrush, that are compatible for use with Cintiq.

- The Art Pen features a pressure-sensitive tip and eraser, as well as sensitivity to tilt and rotation. Rotating the barrel in supporting applications creates a unique effect.
- The Airbrush is a true digital airbrush. It features a pressure-sensitive tip and eraser, tilt sensitivity, and a fingerwheel to control the application of digital paint.

These tools are fully supported in the Wacom driver software. They will appear in the TOOL list of the Wacom Tablet control panel after you touch the pen display screen with the tip of the tool. The control panel will automatically update to show the new tool and the options available for customization.

In supporting applications you can adjust the functionality of the Art Pen rotation or the Airbrush fingerwheel within the application. See the documentation that came with your application for details.

To learn more about these and other optional tools that can be used with Cintiq, visit www.wacom.com and choose the Wacom web site for your region. On the web site you can also learn about applications that currently support the advanced features of these tools.

ADJUSTING TIP FEEL AND DOUBLE-CLICK



To adjust the tip sensitivity of your pen, select the PEN tab.

Customizes the amount of pressure needed to click, draw, or ink.

To create broad brush strokes or to click with a light touch, use a SOFT tip setting. For maximum control while drawing thin lines, use a FIRM tip setting.

Click to [further customize](#) the tip sensitivity.

With your screen cursor positioned over an empty area of the control panel, press down on the pen display screen with your pen tip. Use the pressure bar to determine how hard you must press on the pen to reach maximum pressure.

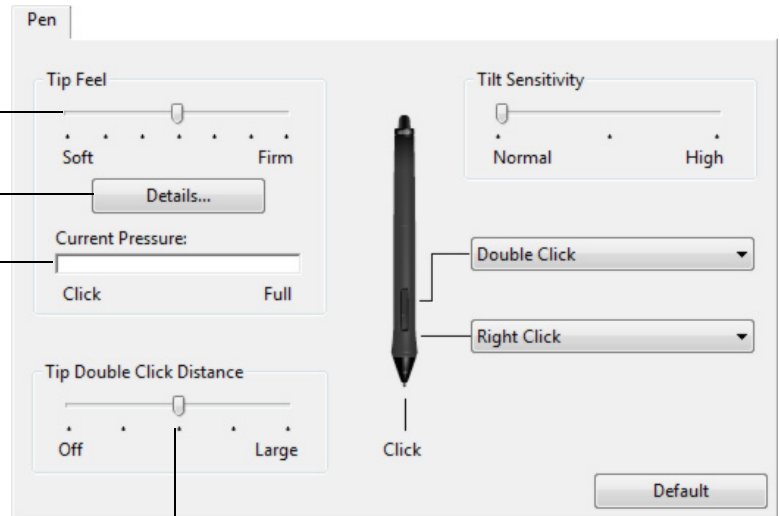

Adjusts the size of the double-click area. Drag slider to OFF if you do not want [double-click assist](#).

Tips:

- Use a soft TIP FEEL for a wider range of pressure values in most pressure-sensitive applications.
- In some applications a soft pressure setting can make the pen overreact so that slight pressure on the pen will be magnified on the screen. If you experience this, try a firmer TIP FEEL setting.
- To make double-clicking easier, expand the tap area that accepts a double-click (the double-click distance).
- A large double-click distance may cause a delay at the beginning of brush strokes in some drawing applications. This may also cause a delay at the beginning of a drag action or inking stroke. If you notice such effects, try setting a smaller double-click distance and using the side switch to double-click. You can also [set an ExpressKey to double-click](#).

ADJUSTING ERASER FEEL



To adjust the eraser sensitivity of your pen, select the ERASER tab.

Customizes the amount of pressure needed to erase.

Click to [further customize](#) the eraser sensitivity.

With your screen cursor positioned over an empty area of the control panel, press down on the pen display screen with your pen eraser. Use the pressure bar to determine how hard you must press on the eraser to reach maximum pressure.

Select the [function](#) to perform when using the eraser.

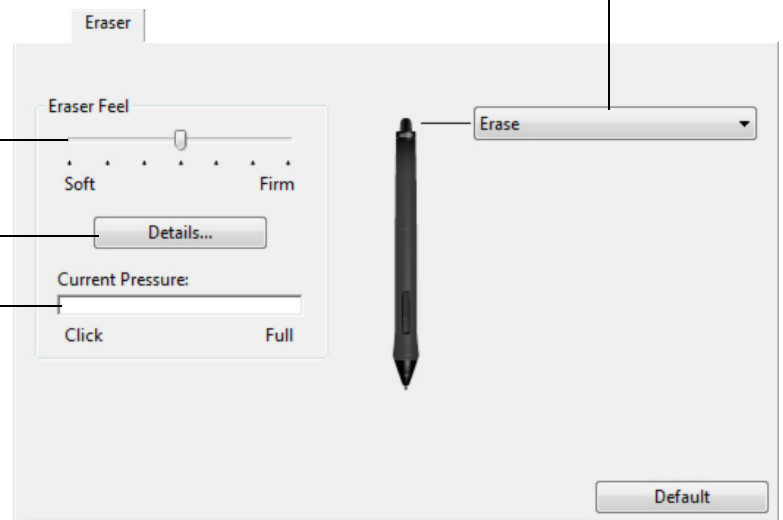

ADVANCED TIP AND ERASER PRESSURE SETTINGS



To further customize tip or eraser pressure settings, select the PEN or ERASER tab and click on the CUSTOMIZE... button. Options within the PEN FEEL DETAILS dialog box enable you to independently change the tip or eraser pressure sensitivity and click threshold settings.

Graphically displays the selected pressure sensitivity curve and click threshold settings.

Move the pressure controls to change the sensitivity curve.

- CLICK THRESHOLD determines the amount of force required to register pressure or generate a tip click.
- Use the SENSITIVITY control to change the slope of the pressure response curve.
- MAX PRESSURE determines how hard you must press the pen tip to reach maximum pressure.

A curve that increases quickly makes the pen feel more sensitive.

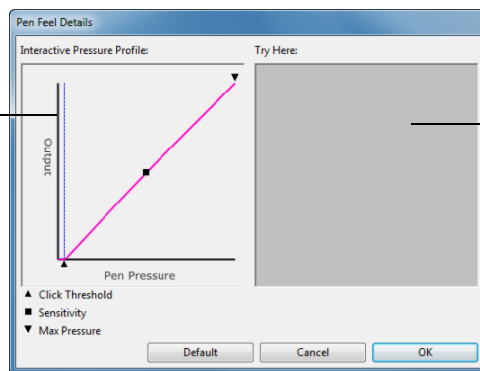

Using your pen tip or eraser, make several strokes within the box to test the results of your changes.

Important: In the PEN and ERASER tabs, these settings are adjusted simultaneously with the TIP FEEL or ERASER FEEL slider, which override the advanced pressure settings.

CUSTOMIZING TOOL BUTTONS



Select the PEN tab to change the functions assigned to the side switches and tip of your pen.

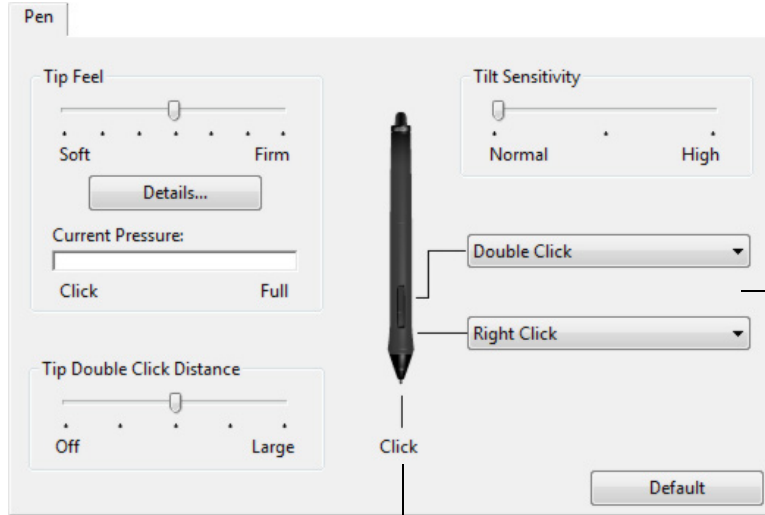

Select the [function](#) to perform when pressing the upper or lower side switch.

The selected function occurs when you bring the pen tip within 5 mm (0.20 inch) of the display screen surface without touching the screen and then press the upper or lower side switch.

Tip: To make double-clicking easier, set the side switch to DOUBLE CLICK.

Double-click here to change the pen tip function.

- At least one tool button should be set to the CLICK function.
- The tip must be set to CLICK in order to draw in most graphics applications.

You can change the SIDE SWITCH MODE to best fit the way you like to use the pen when making right-clicks or other click functions. Click on the control panel OPTIONS... button.

Select:

- HOVER CLICK to perform click functions without touching the pen tip to the display screen surface. This is the default setting for all except Tablet PCs.
- CLICK & TAP to enable the precise placement of click functions. When selected, you must first press the side switch then touch the pen tip to the display screen surface in order perform the function.



Hover click



Click tap

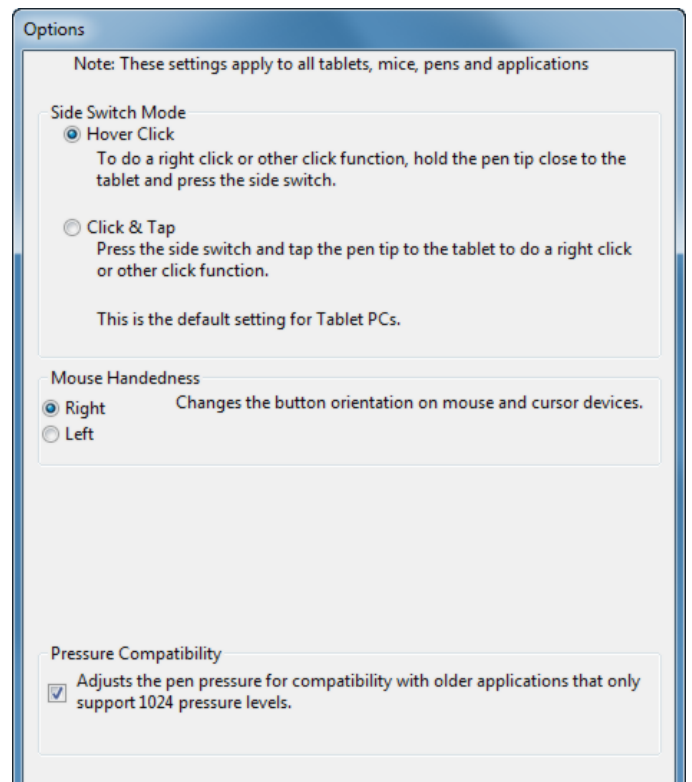

CUSTOMIZING TILT SENSITIVITY



To adjust the tilt sensitivity of your pen, select the PEN tab. Tilt sensitivity determines how far you have to tilt the tool to produce the maximum tilt effect. You need to tilt the pen less at high sensitivity than at low sensitivity.

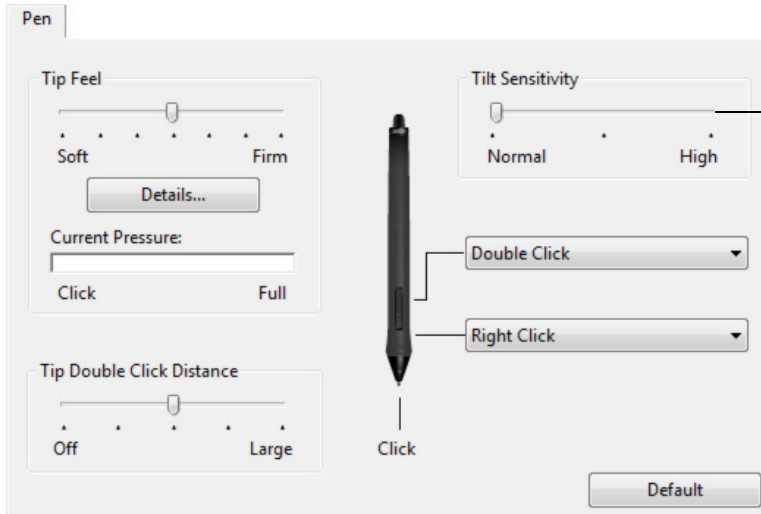

Drag to increase or decrease TILT SENSITIVITY. Test the new setting in an application that supports tilt.

The tilt setting applies to both the tip and eraser of your tool.

Tilt is direction sensitive and can be used in some applications to control brush orientation or other characteristics.

Visit the Wacom web site to learn about applications that currently support tilt. See [product information](#).

CUSTOMIZING PEN DISPLAY FUNCTIONS

To customize the interactive pen display, [open](#) the Wacom Tablet control panel and select the FUNCTIONS icon in the TOOL list. Select a tab to customize, and change settings using the available options.

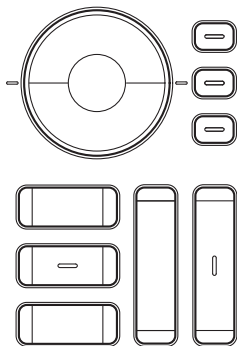

[Customizing the Touch Rings](#)

[Customizing the ExpressKeys](#)

[Working with Display Toggle](#)

[Application-specific settings](#)

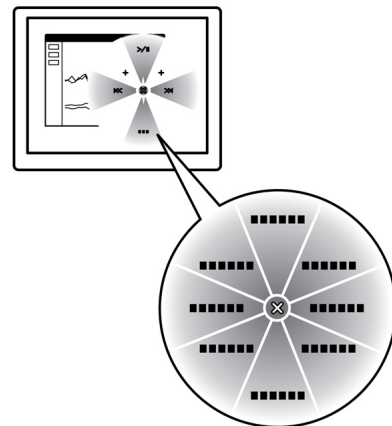

[Using and customizing the Radial Menu](#)

CUSTOMIZING THE EXPRESSKEYS

To customize the ExpressKeys, select the EXPRESSKEYS tab. Each key can be customized to perform a Display Toggle, modifier, keystroke, or other function.

Choose a [function](#) to perform when the key is pressed.

ExpressKey functions can be defined for use with [specific applications](#).

See [using the ExpressKeys](#) for more information.

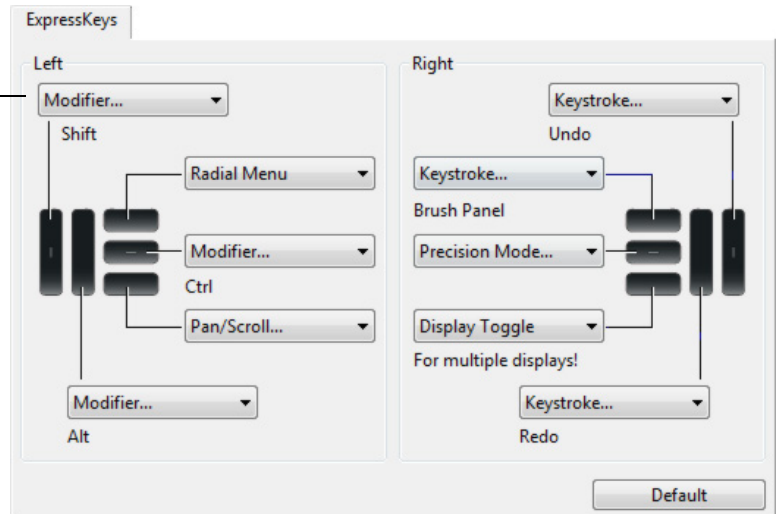

Important: Some applications can override and control the ExpressKey functions. For details, see [using applications integrated for tablet control](#).

CUSTOMIZING THE TOUCH RINGS

To customize the Touch Rings, select the TOUCH RING tab. Touch Ring functions can be modified to perform various zooming, scrolling, or custom keystroke actions. For example, you might set a Touch Ring function to cycle layers when working in Adobe Photoshop.

Choose a [function](#) to perform when using the Touch Ring. Each Touch Ring can be customized for three different modes.

Adjust SPEED to control the rate at which zooming and scrolling occurs, or the speed at which keystroke events are sent to an application.

Touch Ring functions can be defined for use with [specific applications](#).

See [using the Touch Rings](#) for more information.

Enables or disables display of the Touch Ring settings diagram.

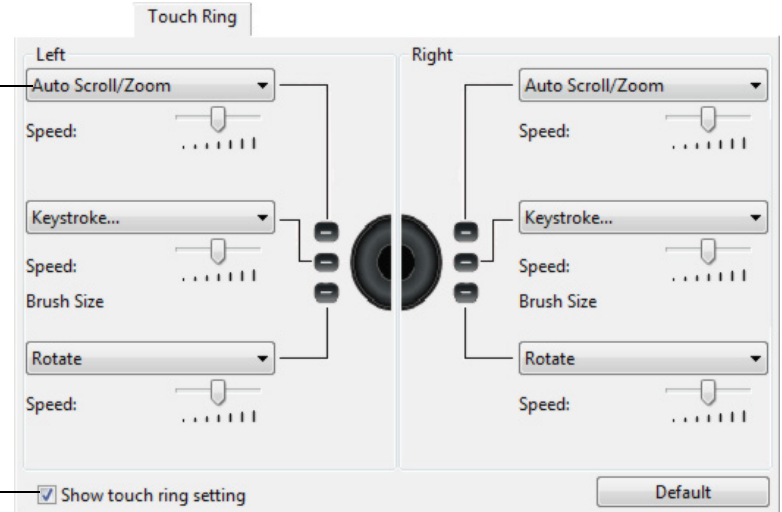

Tips:

- To customize the ring for other actions, select the KEYSTROKE... option and define a custom [keystroke](#) function. To learn which keystroke shortcuts are supported by a particular application, see the documentation that came with the application.
- Choose SKIP to set the Touch Ring mode button to skip the function state.
- To zoom images at the current position of the screen cursor in Adobe Photoshop CS3 or later, open the Adobe Photoshop general preferences pane. Check the ZOOM WITH SCROLL WHEEL option and click OK.

Important: Some applications can override and control the Touch Ring functions. For details, see [using applications integrated for tablet control](#).

BUTTON FUNCTIONS

Customize Cintiq for the way you like to work. Simply use the Wacom Tablet control panel to change the button function that is assigned to a pen button, ExpressKey, Touch Ring, or Radial Menu setting.

Button function options may vary, depending on your pen display model. Not all options are available for all controls or pen display models.

FUNCTION NAME	DESCRIPTION
---------------	-------------

CLICKS

- **CLICK** Simulates a primary mouse button click. Be sure at least one button performs this function so you can always navigate and click.
- **RIGHT CLICK** Simulates a right mouse button click, which displays a context menu.
- **MIDDLE CLICK** Simulates a middle mouse button click.
- **DOUBLE CLICK** Simulates a double-click. For easier double-clicking, use this function instead of tapping twice with the pen tip.
- **CLICK LOCK** Simulates holding down the primary mouse button. Press the pen button once to initiate click lock. Press the button again to release click lock. Click lock is useful for dragging objects or selecting blocks of text.
- **4TH CLICK** Simulates a 4th mouse button click.
- **5TH CLICK** Simulates a 5th mouse button click.



FUNCTION NAME

DESCRIPTION

KEYSTROKE...

Enables you to simulate keystrokes. Select this option to display the DEFINE KEYSTROKE dialog box.

Enter a keystroke or keystroke combination in the KEYS entry box. Keystroke combinations can include letters, numbers, function keys (such as F3) and modifier keys (such as SHIFT, ALT, or CTRL for Windows, or SHIFT, OPTION, COMMAND, and CONTROL for Mac). You can also choose special keystrokes or keystroke combinations from the ADD SPECIAL drop-down menu.

After defining a keystroke or keystroke sequence, click OK.

Important: Because the ENTER (Windows) and RETURN (Mac) keys can be selected as a defined keystroke, they cannot be used to select OK. You must use your pen to click on the OK button.

Enter a name for the keystroke definition. The name will be displayed with the respective control or in the Radial Menu, as applicable.

You can create different keystroke functions for different applications. See [application-specific settings](#).

Deletes the last entry in the keystroke entry box.

Clears the entry box.

To learn which keystroke shortcuts are supported by a particular application, see the documentation that came with the application.

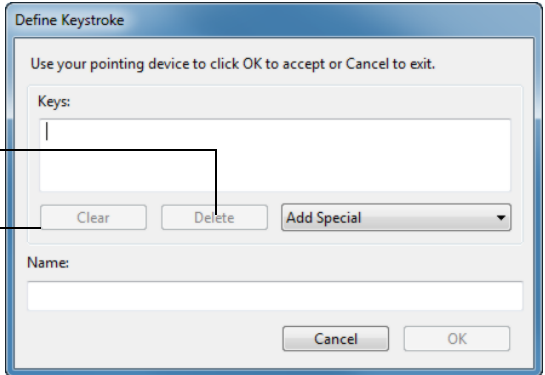

MODIFIER...

Enables you to simulate modifier key(s) (such as SHIFT, ALT, or CTRL for Windows, or SHIFT, OPTION, COMMAND, and CONTROL for Mac). Many applications use modifier keys to constrain the size or placement of objects.

Choose one or more modifier options.

Choose a CLICKS option to simulate pressing a button of the selected type on a mouse.

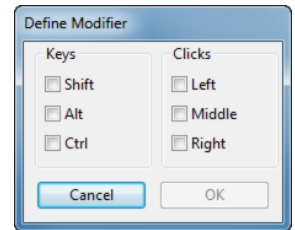

FUNCTION NAME	DESCRIPTION
RADIAL MENU	Displays the Radial Menu on your screen. Each level of the hierarchical menu consists of eight menu slices which may contain various features and options to choose from.
BACK	Simulates the BACK command in browser applications.
FORWARD	Simulates the FORWARD command in browser applications.
PAN/SCROLL...	<p>Enables you to position a document or image in any direction within the active pane. Do this by pressing a pen button set for PAN/SCROLL and then dragging with the pen tip across the pen display screen.</p> <p>When you select PAN/SCROLL, you are prompted to set a scrolling speed for use in applications that do not support grabber hand (pixel-level) panning.</p> <ul style="list-style-type: none"> • A slower setting reduces the scroll rate and is useful for close-up and detail work where you need precise control of the image. • As you move the pen tip, the document or image is repositioned to follow the direction of pen movement on the pen display screen surface. • Release the button or lift the pen tip from the display screen surface when you are done. • In some application windows the document will precisely follow the screen cursor as you move the pen tip, while in others it will simply move in the same general direction as the screen cursor.
SHOW DESKTOP	Minimizes all open windows to display a clean desktop.
SWITCH APPLICATION	Brings up the application switching dialog box with focus on the next open application. On Windows 7 or Vista systems running Aero, Flip 3D will be activated with focus on the next open application.

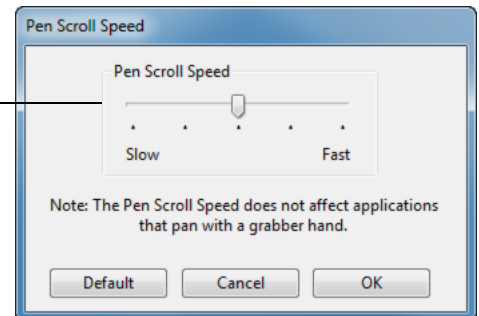



FUNCTION NAME

DESCRIPTION

OPEN/RUN...

Opens a dialog box where you can select a specific application, file, or script to launch.

Click BROWSE... to locate an application, file, or script to launch. The selection you make appears in the NAME box.

Click OK to accept the selection.

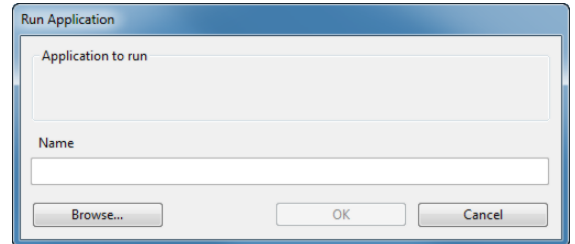

The dialog box will close and the OPEN/RUN... option you have selected will be assigned as the pen button option. Simply press the pen button to launch the assigned option.

If your selection is for the Radial Menu, it will be displayed there.

TOUCH ON/OFF

Available only for Cintiq 24HD touch models. TOUCH ON/OFF is useful when you are working with an input tool and want to exclusively use pen mode. Temporarily disable multi-touch by pressing an ExpressKey to which you have assigned the TOUCH ON/OFF function. Press the ExpressKey again to enable touch. See also [customizing the ExpressKeys](#).

INK TOGGLE

(Mac only.) Toggles the “ink in any application” function of Ink on and off. Ink automatically recognizes and converts your handwriting into text and inserts it into a document. Handwriting recognition must be turned on for this function to work. See your Mac help for information on working with Ink.

ON SCREEN KEYBOARD

Launches the on-screen keyboard when you press the button to which this function is assigned. Press the button to close the keyboard when open.

EXPOSÉ

(Mac only.) Tiles all open windows. To access this option, first choose KEYSTROKE... and then click on the ADD SPECIAL menu within the dialog box.

PRESSURE HOLD

Locks the pressure at the current pressure level until the button is released. For example, you can paint with pressure sensitivity until you reach the brush size that you like. You can then press the button and continue painting with the same size brush until the button is released.



FUNCTION NAME	DESCRIPTION
PRECISION MODE	<p>Changes the mapping around the current pen tip position so that you must move the pen farther for the screen cursor to cover a specific distance on the display screen. This feature can be very useful for the precise control of pen or brush strokes.</p> <p>You can adjust the precision setting when assigning this function to a tool button.</p> <p>To activate:</p> <ul style="list-style-type: none">• For extensive use, toggle on PRECISION MODE by pressing a tool button to which the function has been assigned. Return to normal mapping by again pressing the tool button.• For quick edits, press and hold a tool button to which the function has been assigned. Normal mapping returns when you release the button. <p>When using a tool in mouse mode, screen cursor movement is adjusted to act as if acceleration were off and speed set to slow.</p>
DISPLAY TOGGLE	<p>Available when Cintiq is connected as part of a multiple monitor system. Enables you to toggle the screen cursor between the Cintiq pen display and your other displays. For example: Cintiq can be used as a pen display where the screen cursor is positioned at the pen tip location on the pen display screen surface. Display Toggle enables you to cycle between pen control for Cintiq and your other displays. This is like using Cintiq as a standard Wacom tablet where the screen cursor can be moved across the entire desktop or additional displays.</p>

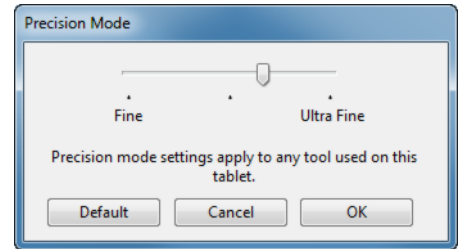

FUNCTION NAME	DESCRIPTION
MODE TOGGLE...	<p>Toggles between pen mode and mouse mode. When using Cintiq on a multiple monitor system, this enables you to use your pen to control the other monitors in mouse mode.</p> <p>When first setting a pen button to MODE TOGGLE..., the MOUSE MODE dialog box is displayed where you can adjust the mouse acceleration and speed.</p> <p>Sets the screen cursor tracking speed when in mouse mode.</p> <p>Sets the screen cursor acceleration when in mouse mode.</p>
ERASE	<p>Pen only. Sets a button so that when the button is pressed, the pen tip will act like the eraser in applications that support the ERASE function. Default setting for the eraser. See erasing.</p>

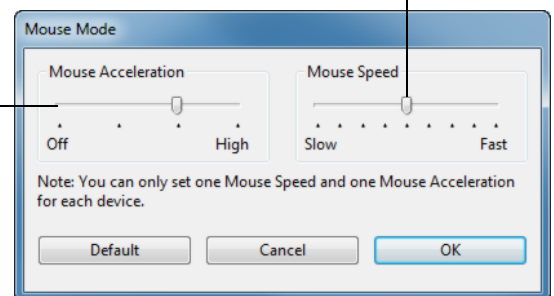

FUNCTION NAME

DESCRIPTION

SETTINGS

Activates (on your display screen) an interactive diagram of the current ExpressKey, Touch Ring, pen, and multi-touch settings. The current functions for each control are shown.

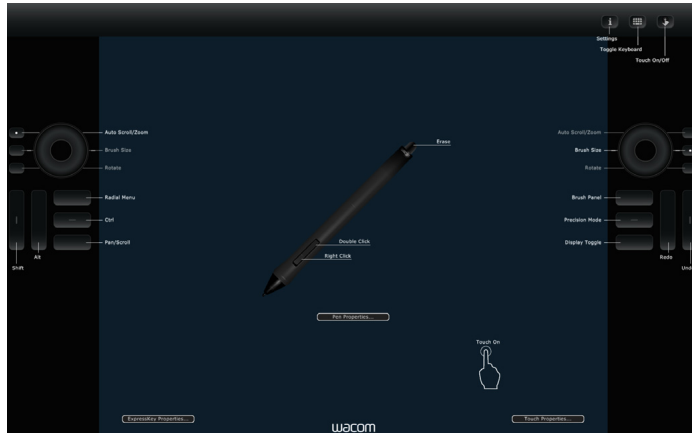

Click on any section of the diagram to open the appropriate Wacom Tablet control panel tab. You can then adjust settings as needed.

Dismiss the diagram by again pressing the ExpressKey or other tool button to which this function is assigned, or by clicking anywhere outside of the diagram.

Settings may vary depending on your product model.

DISABLED

Disables the button function.

APPLICATION DEFINED

Reports only the button number to the application. This is for applications, such as CAD programs, that have built-in tablet support.

DEFAULT

Returns a button to its default setting.

USING AND CUSTOMIZING THE RADIAL MENU

The Radial Menu is a pop-up menu that provides quick access to editing, navigation, media control functions, and more.

- Set a tool button or ExpressKey to the RADIAL MENU function. Press the button to display the Radial Menu.
- Cintiq 24HD touch: You can also use the appropriate multi-touch gesture to open the Radial Menu.
- The hierarchical Radial Menu appears in circular format. Each level of the menu consists of eight control slices which may contain various features and options to choose from.
- Click to select an option. Some selections may display a submenu for additional options.
- The menu closes after you make a selection.

To close without making a selection, click on the 'X' located at the center of the Radial Menu or on a control slice that has no function assigned to it. You can also click outside of the Radial Menu boundary, or again press the button used to display the menu.

- To make a selection without closing the Radial Menu, hold down the button that opens the menu.

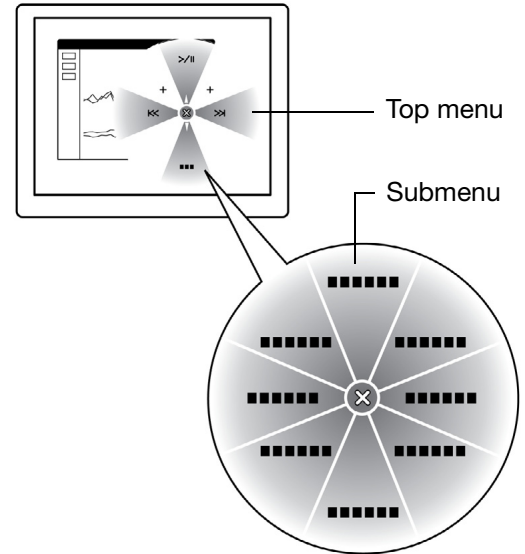

In the Wacom Tablet control panel, use the RADIAL MENU tab to customize the available Radial Menu functions.

1. Select a control slice.
2. Assign a control FUNCTION to the slice. If desired, change the LABEL name.
3. Select a menu or submenu to further customize.

Tips:

- In the FUNCTION menu, choose SUBMENU to create custom submenus for a control slice.
- Press the ENTER (RETURN) key to add multiple lines of LABEL text.

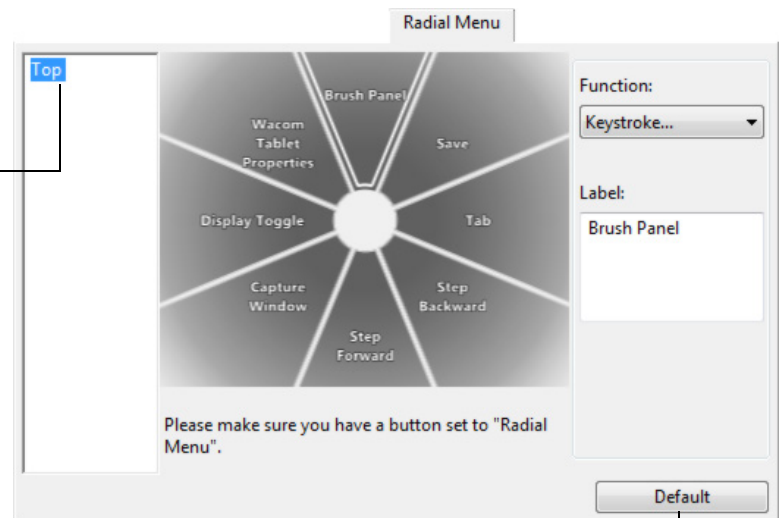

Returns the currently displayed menu to its default values.

WORKING WITH DISPLAY TOGGLE

A Display Toggle feature is available only on multiple monitor systems. Set an ExpressKey or pen side switch to the DISPLAY TOGGLE function. Then press that button to toggle the screen cursor between Cintiq and your other displays. For example, Cintiq can be used as a pen display where the cursor is positioned at the pen tip location, or toggled for use as a standard Wacom tablet where the cursor can be moved across the entire desktop or any display on your system.

Open the Wacom Tablet control panel and make sure Cintiq is the selected TABLET. The DISPLAY TOGGLE tab will be available if the system has two or more displays. The options on this tab define how the tablet mapping is applied to each toggled display.

- PEN DISPLAY TO DESKTOP toggles the screen cursor from Cintiq to the entire system desktop. Press the button a second time to return the cursor to Cintiq.
- PEN DISPLAY TO OTHER DISPLAYS toggles the screen cursor from Cintiq to another active pen display or monitor. The cursor toggles to each connected display in turn until it returns to the Cintiq from where the initial toggle began.

Important: When using application-specific settings with Display Toggle, be sure each customized application (including ALL OTHER) has a tool button to which DISPLAY TOGGLE has been assigned. The easiest way to do this is to assign DISPLAY TOGGLE to an ExpressKey before creating any application-specific settings.

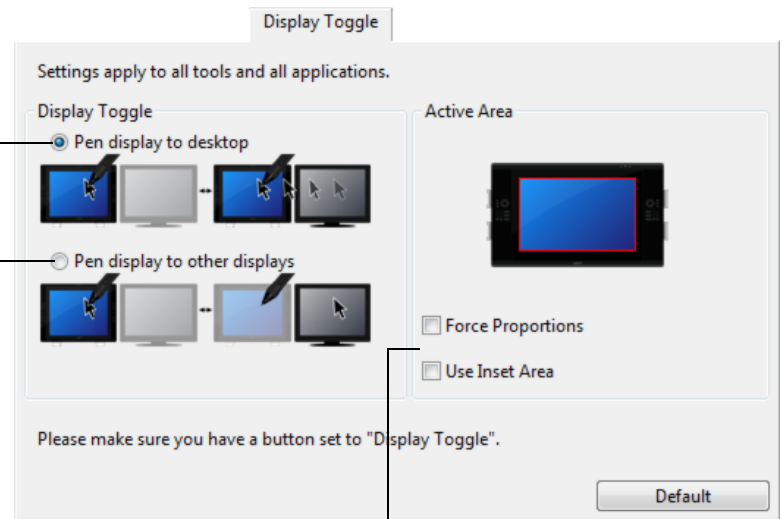

ACTIVE AREA options determine the size of the area where the pen will function on the pen display.

- FORCE PROPORTIONS adjusts the size of the active area to maintain correct vertical and horizontal proportions between Cintiq and the entire desktop or newly mapped-to display. Depending on your settings, some portions of the active area may no longer be usable when this option is selected. When deselected, the correct scale or proportions are not maintained. For example, drawing a circle on the pen display may create an ellipse on a mapped-to display screen.
- USE INSET AREA limits the active area to a sizing of 6 x 8 inches. If FORCE PROPORTIONS is also selected, this sizing may be less. When deselected, as much of the active area as possible will be used for tablet-to-display mapping.

Your selection is shown by the red box in the ACTIVE AREA diagram.

APPLICATION-SPECIFIC SETTINGS

You can customize your tools for use with a particular application. For example, you may prefer a firm pen tip pressure setting in one application and a soft pressure setting in another. The APPLICATION list enables you to add an individual application to the list and then customize your tool settings for that application.

- When no application-specific settings have been created and a tool is selected from the TOOL list, the APPLICATION list displays the ALL icon which contains tool settings that apply to all of your applications. In the example below, no application-specific settings have been added for the GRIP PEN. The ALL icon is displayed and the GRIP PEN will have the same settings in all applications.

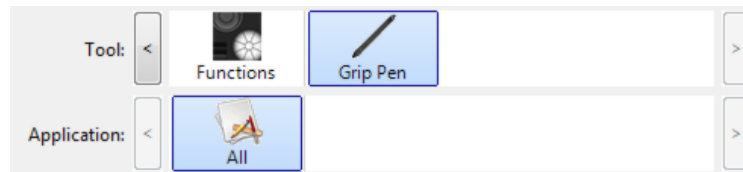

- When application-specific settings are added, the ALL icon changes to ALL OTHER and an application icon is displayed for the newly added application(s).

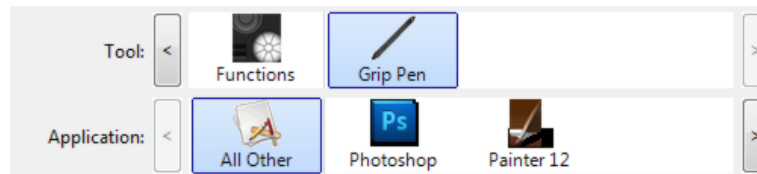

In the above example, application-specific settings have been added for the GRIP PEN. If you select the ALL OTHER icon and make changes to the GRIP PEN settings, your changes will apply to the GRIP PEN in all applications except those which you have added to the APPLICATION list. If you select an application icon and make changes to the GRIP PEN settings, your changes will apply to the GRIP PEN while you are using that application only.

When you create application-specific settings, you are creating a separate group of settings for the selected tool and application. See the following sections for more details:

[Creating an application-specific setting](#)

[Changing application-specific settings](#)

[Removing application-specific settings](#)

Tip: To review ExpressKey, Touch Ring, or pen function settings for the front-most application, set an ExpressKey to SETTINGS and press the key at any time.

CREATING AN APPLICATION-SPECIFIC SETTING

First choose the pen display and input tool for which you want to create an application-specific setting.

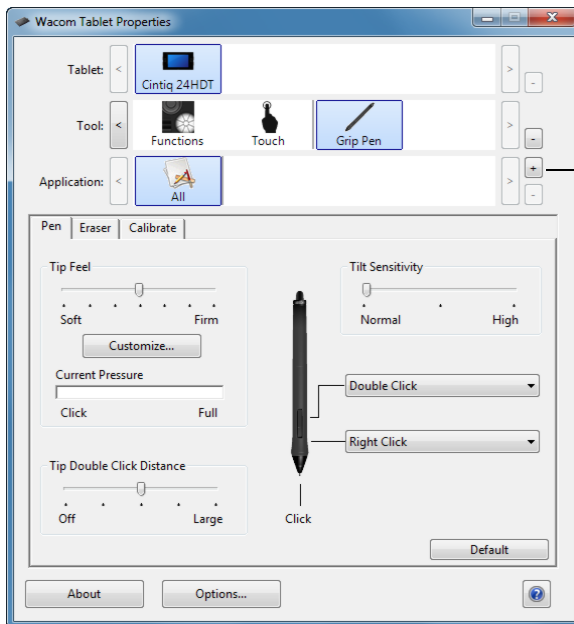

Click on the APPLICATION list [+] button.

Choose a method to select an application:

- Open the application for which you want to create custom settings, and then select that application from the CURRENTLY OPEN APPLICATIONS box.
- BROWSE to select the executable file of any application installed on your computer.

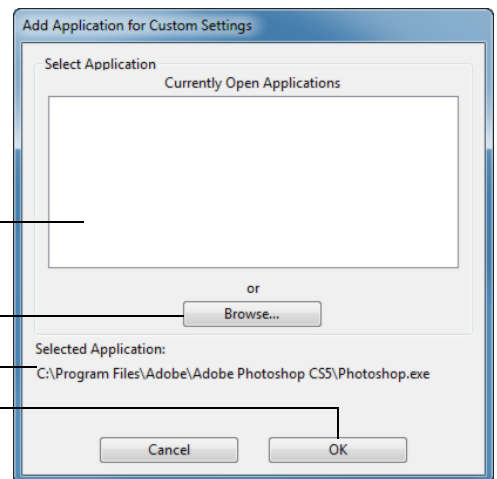

The name of your selected application is displayed.

Click OK to complete the process.

Note: If two programs have the same executable file name, they will share the same customized settings.

After adding an application, its icon appears in the APPLICATION list whenever the respective tool is selected in the TOOL list. Select the application and then customize the control panel tab settings for your tool and selected application.

Once you have created application-specific settings, applications that have not been customized in this manner will use the tool settings for ALL OTHER.

Tip: First customize settings for one application. When you feel comfortable with the process, you can create more application-specific settings.

CHANGING APPLICATION-SPECIFIC SETTINGS

To change tool settings for a specific application, select the tool and the application. Then customize the tab settings.

REMOVING APPLICATION-SPECIFIC SETTINGS

To remove an application-specific setting:

1. In the **TOOL** list, select the tool from which you want to remove the application-specific setting. Then, in the **APPLICATION** list select the application you want to remove from the list.
2. Click on the **APPLICATION** list [-] button. In the dialog box that appears, click **DELETE** to confirm your selection. The selected application is removed from the list, along with any custom tool settings.

Tip: To quickly remove all application-specific settings from a single tool, remove it from the **TOOL** list. Then place the tool back on the pen display. The tool will be added back to the **TOOL** list using the default settings. This method cannot be used to remove custom **FUNCTIONS** settings. See [working with multiple tools](#).

WORKING WITH MULTIPLE TOOLS



The Wacom Tablet control panel is designed to help you customize and keep track of the settings for your Cintiq tools. The tool you use to open the control panel is automatically selected, and the appropriate tabs for that tool are displayed.

The TOOL list displays an icon for the pen display FUNCTIONS and different tools that have been used on the pen display.

The TOUCH icon is available for the Cintiq 24HD touch model. See [customizing multi-touch](#).

If application-specific settings have not been added, the ALL icon is displayed and the tool settings apply to all applications.

Tab settings apply only to the selected tool and application.

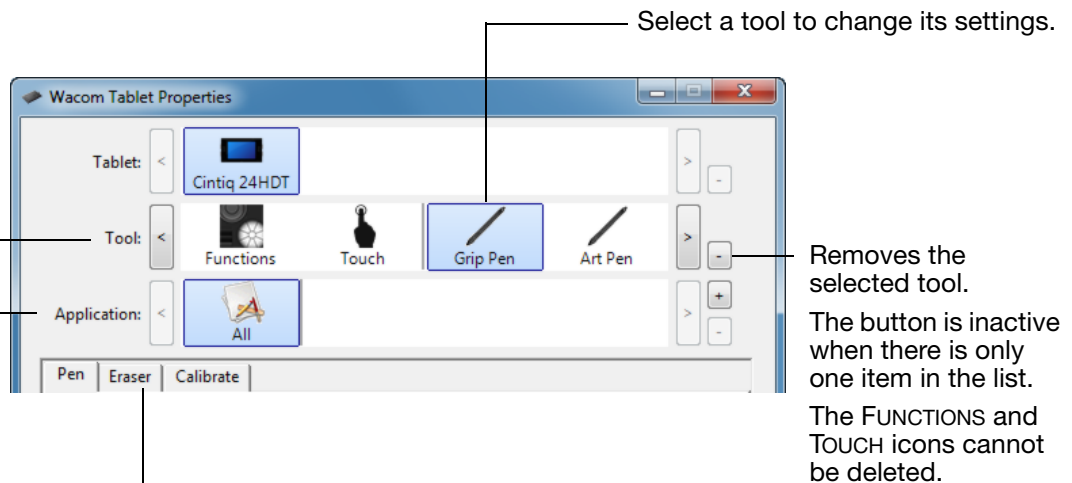

To add a different tool to the TOOL list, simply use the tool on your interactive pen display.

- When you select a tool that has been added to the TOOL list, the appropriate tab settings for that tool are displayed. Any changes you make to the tab settings will then apply to the tool. Your changes take effect immediately.

If a similar tool was previously added, the new tool will inherit the settings of the previously added tool. These settings can then be customized for the newly added tool.

- Identical tools will use the same settings.

To remove a selected tool from the TOOL list, click on the TOOL list [-] button. In the dialog box that appears, click DELETE to confirm your selection. The selected tool is removed from the list, along with any custom settings you may have created for it. (A removed tool can be added back to the TOOL list by placing it back onto the pen display screen.)



RENAMING THE TABLET IN THE TABLET LIST

Within the control panel TABLET list, double-click on the pen display icon.

If desired, enter a new name to be used for the pen display icon.

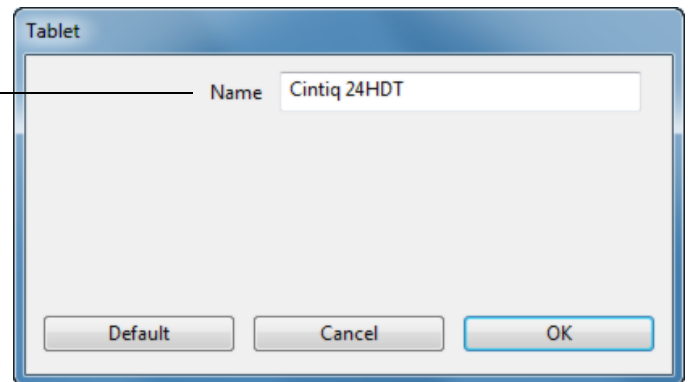



TROUBLESHOOTING

If you are having trouble, Wacom recommends you do the following:

1. If the Wacom driver failed to load properly, first perform the recommended action in any error message that may appear on your screen. If that does not solve the problem, review the troubleshooting procedures in this chapter.
2. If Cintiq does not function properly, refer to [display troubleshooting](#) or [pen tablet troubleshooting](#). Your problem may be described there and you can try the solution offered.
3. Open the Wacom pen display Read Me file and look for any information updates.
4. Visit www.wacom.com and choose the Wacom web site for your region where you can check the product FAQs ([Frequently Asked Questions](#)).
5. If you are having a compatibility conflict between Cintiq and a new hardware or software product, see [obtaining software updates](#) for information on downloading an updated software driver. Wacom periodically updates the software driver to maintain compatibility with new products.
6. Try [testing Cintiq](#).
7. If you have tried the suggestions in this manual and still cannot resolve the problem, then contact Wacom for Technical Support. See the [technical support options](#) and the Read Me file for information on where to obtain support for your region.

[Testing Cintiq](#)

[Testing controls and input tools](#)

[Display troubleshooting](#)

[Pen tablet troubleshooting](#)

[Technical support options](#)

[Obtaining software updates](#)





TESTING CINTIQ

1. If the interactive pen display power LED does not light, check the following:

- First verify that the light on the power adapter is on. If the light is not on, check that the power cable is properly connected between the power adapter and an active AC outlet.
- Check that the power adapter cable is securely connected to the Cintiq display stand extension cable for power and that the pen display power switch is turned on. The power LED will glow orange or blue whenever the pen display is on.

Important: Use only an AC adapter specified for use with your pen display. Other adapters may cause damage to your product.

2. If there is no display:

- Make sure that your computer is turned on. The power LED will glow blue when the proper video signal is received. It will glow orange if there is no video signal or if the computer is in a power saving mode.
- Verify that the pen display is connected to an active digital (DVI or DisplayPort) or analog (VGA) video port.
- Check that your video card has been properly installed and is functional. If you have another display that is compatible with your video card, you can connect that display to the card in order to verify that the video card is operating correctly.

3. Verify that the pen and the tablet portion of your pen display are working:

- Press the pen tip against the display and verify that the status LED lights blue.
- If the LED does not light, verify that the USB cable is plugged into an active USB port. If Cintiq is plugged into a USB hub, try plugging it directly into the USB port on your computer.
- Be sure that the USB port to which you are connecting has not been disabled. It may be necessary to check your system BIOS setting to verify that you have connected the pen display to an active USB port.
- The status LED will light blue when Cintiq is registered as a USB device and the pen tip is pressed against the display.

4. Check the pen. If you cannot make a selection on the display screen with the pen:

- Test the pen by pressing the pen tip or eraser against the surface of the pen display. The pen display status LED should light blue.
- Now, without applying pressure to the pen tip but keeping the pen within 5 mm (0.2 inch) of the pen display surface, press the side switch. The status LED should again light blue.
- If the status LED does not light blue for these tests, be sure you are using a pen specified for use with your product.
- See [testing controls and input tools](#) and [testing a pen](#) for more information.





5. Check multi-touch. Attempt to move the screen cursor by touching your finger in different places on the pen display surface. Touch to select an item. The status LED should brighten. See also [testing multi-touch](#).

If the tablet driver does not load properly, basic touch movement will be recognized but other actions and gestures will not. If gestures are not recognized, install the driver software.

6. Check the hardware control buttons. See [testing controls and input tools](#) and [testing the hardware control buttons](#).
7. Check the ExpressKeys. See [testing controls and input tools](#) and [testing the ExpressKeys](#).
8. Check the Touch Rings. See [testing controls and input tools](#) and [testing the Touch Rings](#).
9. Check any other tool(s), such as the optional Airbrush. See [testing controls and input tools](#).

If you are still having problems, you may have a defective pen or pen display.

After testing, use the Wacom Tablet control panel to reconfigure your tablet and tools for any custom settings you may originally have been using.



TESTING CONTROLS AND INPUT TOOLS

If the Grip Pen or the Cintiq controls do not work as you expect, it is a good idea to first check the assigned functions or reset them to their default conditions. You will also want to do this if you have a touch-sensitive model and encounter problems with multi-touch.

A quick way to return a pen to its default condition is to remove it from the control panel TOOL list. Do this by selecting the pen and clicking on the TOOL list [–] button. After the pen has been removed, place it back onto the display screen surface. The pen will be added back to the TOOL list with its default settings.

- Open the Wacom Tablet control panel and click on the ABOUT button. In the dialog box that appears, click DIAGNOSE.... The DIAGNOSTICS dialog box shows dynamic information about the Cintiq pen display, your input tool(s), and appropriate information for touch-sensitive models.

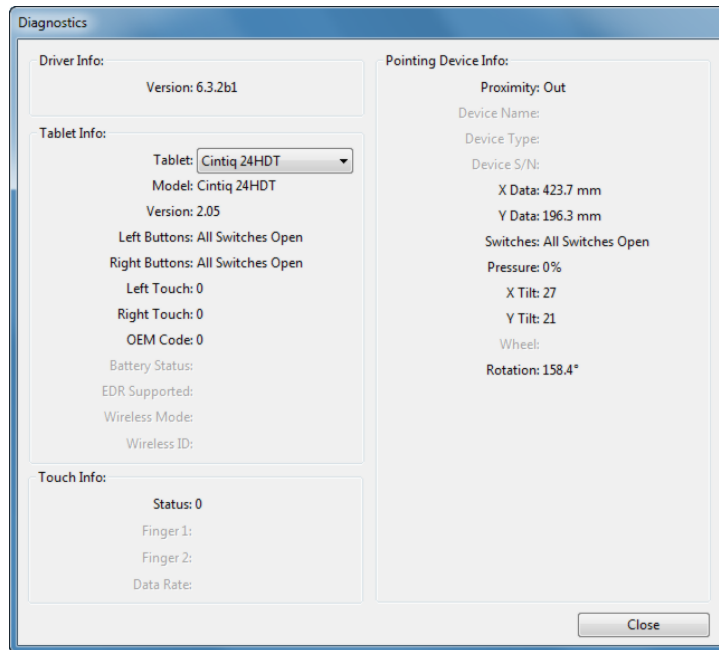

- If more than one pen display or tablet is connected to your system, in the TABLET INFO column select the product you are testing.
- Use the information shown in the DIAGNOSTICS dialog box when testing your pen display and pen.

Note: If a tool button is set to RADIAL MENU or OPEN/RUN..., that function will occur when the button is pressed. In this case you may want to change the button function before testing.

[Testing the hardware control buttons](#)

[Testing the ExpressKeys](#)

[Testing the Touch Rings](#)

[Testing a pen](#)

[Testing multi-touch](#)

TESTING THE HARDWARE CONTROL BUTTONS

1. With the DIAGNOSTICS dialog box open, observe the TABLET INFO column as you test each of the three hardware control buttons located on the upper front of your interactive pen display. Be sure to select the pen display you are testing from the TABLET INFO column.
2. Test the buttons by pressing them one at a time. Each time you press a button, its number is shown next to the either the LEFT BUTTONS or RIGHT BUTTONS category.
3. When you are done, click the CLOSE button to exit the dialog box.

TESTING THE EXPRESSKEYS

1. With the DIAGNOSTICS dialog box open, observe the TABLET INFO column as you test each ExpressKey. Be sure to select the pen display you are testing from the TABLET INFO column.
2. Test the keys by pressing them one at a time. Each time you press a key, its number is shown next to either the LEFT BUTTONS or RIGHT BUTTONS category, depending on which keys group you are testing.
3. When you are done, click the CLOSE button to exit the dialog box.

Important: Some applications can override and control the ExpressKey functions. Consider closing any open applications except the Wacom Tablet control panel when testing the ExpressKeys. For details, see [using applications integrated for tablet control](#).

TESTING THE TOUCH RINGS

1. With the DIAGNOSTICS dialog box open, observe the TABLET INFO column as you test each Touch Ring. Be sure to select the pen display you are testing from the TABLET INFO column.
2. Slide your finger around the entire circumference of each Touch Ring. A number is shown next to either the LEFT TOUCH or RIGHT TOUCH category, depending on which Touch Ring you are testing.
3. Press the Touch Ring mode buttons. Status LEDs show the active mode. As you press each button, an overlay will appear briefly on your display screen to show the button function assignments. Within the DIAGNOSTICS dialog box, the button number is shown next to either the LEFT BUTTONS or RIGHT BUTTONS category, depending on which buttons group you are testing.
4. When you are done, click on the CLOSE button to exit the dialog box.

Important: Some applications can override and control the Touch Ring functions. Consider closing any open applications except the Wacom Tablet control panel when testing the Touch Ring. For details, see [using applications integrated for tablet control](#).



TESTING A PEN



1. With the DIAGNOSTICS dialog box open, and while observing the POINTING DEVICE INFO column, bring your pen within 5 mm (0.2 inch) of the display screen. A value for PROXIMITY, the DEVICE NAME, DEVICE TYPE, and a DEVICE S/N (serial number) should be displayed. Be sure to select the pen display you are testing from the TABLET INFO column.
2. Move your tool along the pen display screen surface. The X and Y DATA values should change to reflect the tool position.
3. Test your pen switches. The Cintiq status LED should light blue each time you click with the tool tip, press the side switch, or press the tool eraser to the display screen.
 - Press on the display screen surface with the tool tip. The SWITCHES state and PRESSURE value should change. PRESSURE should change from approximately 0% with no pressure applied to approximately 100% when full pressure is applied.
 - Next, press the side switch without pressing the tip to the tablet. The SWITCHES state should change. For the Grip Pen, do this for both positions of the switch.

Pen	Tip = 1
SWITCHES states	Side switch (lower position) = 2 Side switch (upper position) = 3 Eraser = 1

Airbrush	Tip = 1
SWITCHES states	Side switch = 2 Eraser = 1

- Press the eraser to the display screen. The SWITCHES state and PRESSURE value should change. PRESSURE should change from approximately 0% with no pressure applied to approximately 100% when full pressure is applied.
 - For the optional Airbrush, move the fingerwheel forward. The WHEEL value should decrease to a value of approximately 0 when the fingerwheel is all the way forward. Move the fingerwheel backward. The WHEEL value should increase to approximately 1000 when the fingerwheel is all the way back.
4. Test tilt for the x-axis by moving the pen from a vertical position toward the right; the X TILT value should change from approximately 0 to +60. Now move the tool to the left of vertical; the X TILT value should change from approximately 0 to - 60.
 5. Test the tilt for the y-axis by moving the pen from a vertical position toward the bottom of the tablet; the Y TILT value should change from approximately 0 to +60. Now move the tool toward the top of the tablet; the Y TILT value should change from approximately 0 to - 60.
 6. For the optional Art Pen, test the rotation feature by placing the pen tip on the display screen surface and slowly rotating the pen on its axis. The ROTATION value should change as you rotate the pen.
 7. When you are done, click on the CLOSE button to exit the dialog box.



DISPLAY TROUBLESHOOTING

If you encounter problems with the display portion of the interactive pen display, refer to the following tables. Your problem may be described here and you can try the solution offered. For more information about color issues, see the documentation that came with your operating system or applications.

[General display problems](#)

[VGA problems](#)

GENERAL DISPLAY PROBLEMS

No display. Power LED is off.	Verify the AC power cable is connected, and that the pen display power switch is turned on.
No display. Power LED is lit blue.	<ul style="list-style-type: none"> • Check the contrast, brightness, and backlight controls. Adjust as necessary. Or, press the RESET button. • Ensure that a supported video mode has been selected on your display card or computer system. See the display card or system manual for information about changing the graphics mode. • <u>Cintiq 24HD touch</u>: Open the OSD menu and check the EDID EXTENSION setting.
The power LED is lit orange. A 'no signal go to power save' message appears briefly on the display screen.	<ul style="list-style-type: none"> • Your computer may be in a power management mode. Touch the pen tip to the display screen, move the mouse, or depress any key on your keyboard. • Check that the video cable is properly connected. • Turn off both your computer and the pen display. Check the video cable for bent or broken connector pins. Then properly connect the video cable and turn on the pen display and your computer. • Verify that the video card is properly installed.
A 'cable disconnect go to power save' message appears briefly on the display screen.	<ul style="list-style-type: none"> • Check that your computer is turned on. • Verify that you are using the video cable that came with the pen display. • Check that the video cable is fully connected. • Turn off both your computer and the pen display. Check the video cable and any video adapters for bent or broken connector pins. Then properly connect the video cable and any necessary adapters.





An 'out of range' message appears briefly on the display screen.

- The input signal frequency is incorrectly set or not compatible with the interactive pen display. Set the refresh rate to a vertical frequency that is compatible with your pen display. If your video card driver supports adjustment of the horizontal frequency, make sure it is also set to a compatible value. See the Important Product Information guide for frequency range details. On a single monitor system you will need to connect a different display to change the refresh rate.
- The resolution or refresh rate is set too high. See the Important Product Information guide for details about the maximum (native) resolution, refresh rate, and other resolution sizes that can be used with your pen display.
- For optimum performance, set the refresh rate to use a vertical frequency of 60 Hz.
- Set the display properties to detect plug and play monitors.

A 'set refresh range' message appears briefly on the display screen.

- Set the refresh rate to a vertical frequency that is compatible with your pen display. See the Important Product Information guide for frequency range details.
- For optimum performance, set the refresh rate to use a vertical frequency of 60 Hz.

The image appears multiple times on the display.

Do not extend the video cable or use an input selector switch box.

When a still image is displayed for a long period of time without refreshing the screen, an after-image remains for a short period of time.

Prevent image persistence by using a screen saver or other power management feature.

Color quality is inaccurate.

- RESET the interactive pen display.
- Check the color profile settings that you are using with Cintiq.
- Any changes to the contrast setting should be made in small increments as changes in contrast may affect color accuracy.
- Cintiq 24HD touch: Ensure SET COLOR VISION EMU is set to OFF.

Color irregularities appear on the display screen.

- Reduce the brightness.
- Cintiq 24HD touch: Set UNIFORMITY to a value of 5.



The color white does not display as white.

- Check the color profile settings that you are using with Cintiq.
- Verify that the display is operating at the factory default settings. If that is not sufficient, then adjust color as necessary. For details on color management, refer to your operating system and application documentation.
- Verify that the video cable and port are fully connected.

Picture has loss in brightness.

Increase the brightness level or RESET the interactive pen display. LCD brightness degradation may occur due to long-term usage or extremely cold conditions.

Cintiq 24HD touch:

- Ensure that ECO MODE is turned off.
- In PICTURE MODE, set to NATIVE.

Cintiq 24HD touch:

Power LED flashes a pattern of long and short blinks.

The pen display is equipped with the ability to self-diagnose abnormalities. When the LCD detects a problem, the LED flashes in a pattern of long and short blinks depending on the type of problem detected. If this occurs, contact Wacom for Technical Support. See the [technical support options](#) and the Read Me file for information on where to obtain support for your region.

VGA PROBLEMS

The display ripples or flickers.

- Open the OSD menu and select the AUTO ADJUST option. Then, if necessary, manually adjust pitch and phase.
- Verify that the display adapter or video card matches the specifications for the interactive pen display.
- Adjust the refresh rate in the display properties control panel.

The display is not clear. Text or other portions of the screen appear blurred.

- Set the display resolution of your video card to the maximum (native) resolution that can be used with your pen display. See the Important Product Information guide for details.
- For optimum performance, set the refresh rate to use a vertical frequency of 60 Hz.
- Turn off the pen display, then turn it back on.
- Open the OSD menu and select the AUTO ADJUST option. If necessary, manually adjust the brightness, pitch, and phase settings.

The display and LCD panel are not lined up. The display size is not correct.

- Open the OSD menu and select the AUTO ADJUST option.
- As necessary, adjust pitch and phase, and horizontal and vertical position. Note that some video cards may not show the display in proper sizing.

The display ripples or shows a moiré pattern. The display color is not even.

- Open the OSD menu and select the AUTO ADJUST option. If this does not solve the problem, choose RESET to return the display back to the factory default settings.
- As necessary, adjust pitch and phase.

PEN TABLET TROUBLESHOOTING

If you encounter problems with the tablet portion of the interactive pen display, see the following tables. Your problem may be described here, and you can try the solution offered. See the pen display Read Me file for the latest information updates.

For additional information, visit the Wacom web site at <http://www.wacom.com>.

[General problems](#)

[Pen problems](#)

[Multi-touch problems](#)

[Windows-specific problems](#)

[Mac-specific problems](#)

GENERAL PROBLEMS

The computer does not have an available USB port.	Check if there is an available USB port on a USB hub. If not available you will need to add a USB hub or USB card.
A USB device plugged into the pen display USB accessory port does not function.	<ol style="list-style-type: none">1. Make sure the pen display itself is properly connected to a working USB port on your computer.2. Be sure the pen display is powered on and that the power LED lights blue. The pen display contains a powered USB hub and the accessory port will not work when the power is off.3. If the USB device does not work, try plugging it into a USB port directly on your computer.4. If the USB device still does not function properly, contact the manufacturer for that particular device.
The Cintiq power LED is off.	<p>Make sure the pen display power switch is turned on.</p> <p>Check that the AC power adapter is plugged into both the Cintiq display stand extension cable for power and an active power outlet.</p> <p>Use only a power adapter specified for use with your pen display. Other adapters may cause damage to your product.</p>





When using Cintiq on a multiple monitor system, you cannot use the pen to control the other monitor(s).

Cycle between pen control for Cintiq and your other displays by pressing an ExpressKey or pen button that is set to [DISPLAY TOGGLE](#).

You can also use your pen to control the other monitors in mouse mode. To use mouse mode, first set a pen button to MODE TOGGLE.... Then use the button to toggle between pen mode and mouse mode.

The computer does not go to sleep.

When you are not using the pen, remove it from the pen display surface or Cintiq will continue to send data, keeping the computer awake.

The screen cursor jumps back when using your regular mouse or trackball.

When not in use, place the pen in the pen stand or in some other location near the pen display. Do not leave the pen on the display. Leaving your pen on the display may interfere with screen cursor positioning when using other input devices.

The screen cursor moves erratically or jumps around on the display screen when another tablet is connected to your computer.

The tablet portion of Cintiq emits electromagnetic waves at a certain frequency. If another tablet is too closely placed to the pen display it may interfere with screen cursor positioning. If this occurs, move the tablet further away from Cintiq.

When working in some applications, the ExpressKeys or Touch Rings perform a different function than what is set in the Wacom Tablet control panel.

Some applications can override and control the ExpressKey and Touch Ring functions. See [using applications integrated for tablet control](#).

If using application-specific settings, be sure you have updated the settings for the application you are working with.

The ExpressKeys and Touch Rings do not perform the correct functions to which they are set.

Check to be sure that Cintiq is correctly configured for your preferred handedness. See [configuring Cintiq for handedness and orientation](#).

Some control panel defaults are different from those shown in the manual.

In some regions the control panel defaults may vary, depending on application and operating system differences.



PEN PROBLEMS



The pen works only in mouse mode, and does not draw or write with pressure sensitivity.

The driver software for the tablet portion of the pen display was not installed or did not load properly.

For pen display models that combine pen and multi-touch, basic touch movement will continue to be recognized, but other actions and gestures will not.

- Make sure the driver software is installed and functioning.
- Install the driver software in accordance with [step 2: software installation](#).

The pen does not draw or write with pressure sensitivity.

Some applications require that you turn on the pressure capabilities within the application or selected tool before the pen will respond as a pressure-sensitive tool.

Verify also that your application supports pressure sensitivity.

Clicking is difficult.

Open the Wacom Tablet control panel and go to the PEN tab. Try using a lighter TIP FEEL.

The pen selects everything or will not stop drawing.

Open the Wacom Tablet control panel and go to the PEN tab. Move the TIP FEEL slider toward FIRM, or select CUSTOMIZE... and increase the CLICK THRESHOLD setting. If this does not help, see [testing controls and input tools](#).

The pen nib may be worn. See [replacing the pen nib](#).

Double-clicking is difficult.

Be sure you are quickly tapping the display screen twice in the same place. Wacom recommends using the side switch to double-click.

Open the Wacom Tablet control panel and go to the PEN tab.

Try increasing the TIP DOUBLE CLICK DISTANCE or using a lighter TIP FEEL.

Set an ExpressKey to DOUBLE CLICK and use it to issue double-clicks.

Windows: Try setting your system to launch programs with a single click. See [clicking](#).

The eraser selects everything or will not stop erasing.

Open the Wacom Tablet control panel and go to the ERASER tab.

Move the ERASER FEEL slider toward FIRM, or select CUSTOMIZE... and increase the CLICK THRESHOLD setting. If this does not help, see [testing controls and input tools](#).





You notice a delay at the beginning of pen or inking strokes.

Open the Wacom Tablet control panel and go to the PEN tab. Try decreasing the TIP DOUBLE CLICK DISTANCE. If that does not work, move the TIP DOUBLE CLICK DISTANCE slider to the OFF position in order to turn off double-click assist.

You have to press hard with the pen when clicking, drawing, or writing.

Open the Wacom Tablet control panel and go to the PEN tab. Move the TIP FEEL slider toward SOFT, or select CUSTOMIZE... and decrease the SENSITIVITY and CLICK THRESHOLD settings.

The pen tip does not function.

Be sure you are using only the pen that came with your product, or a Wacom accessory pen specified for use with Cintiq. Other pens may not function properly on the pen display.

Check the control panel PEN tab and verify that a CLICK function is assigned to the pen tip.

Make sure the status LED lights blue when the tip is pressed. If the LED does not light, verify that the USB cable is plugged into an active port on your computer or on a USB hub.

If the LED still does not light, you may have defective hardware (see [troubleshooting](#)).

The pen tip and screen cursor do not properly line up.

Open the Wacom Tablet control panel and select the CALIBRATE tab. Continue with [calibrating the pen display](#).

Changing the function settings for a pen has no effect.

Make sure you change the settings for the tool and application that you are using. See [application-specific settings](#) and [working with multiple tools](#).

The line you are drawing does not line up with the location of the screen cursor.

To function properly, some applications require that the pen be set to pen mode. Make sure the pen has not been toggled to mouse mode.

If you have set the pen to pen mode and the problem still exists, then you may have a corrupted preferences file. Follow the instructions in [Windows-specific problems](#) or [Mac-specific problems](#) to create a new preferences file.



The pen side switch does not work.

Be sure you are using only the pen that came with your product, or a Wacom accessory pen specified for use with Cintiq. Other pens may not function properly on the pen display.

Be sure to press the side switch when the pen tip is within 5 mm (0.2 inch) of the pen display active area. Do this without pressing down on the pen tip.

In the Wacom Tablet control panel, verify that the side switch is set to the proper function you are expecting to occur for the application and tool you are using.

Check also the SIDE SWITCH MODE. If CLICK & TAP is selected, you will need to first press the side switch then touch the pen tip to the pen display screen surface in order to perform a click function.

Make sure the status LED lights blue when you press the side switch. If not, verify that the USB cable is plugged into an active USB port on your computer or on a USB hub. The LED will not light if the USB cable is not plugged into an active port.

If the LED does not light, you may have defective hardware (see [troubleshooting](#)).

The screen cursor moves but it does not jump to the pen tip location when placed on the display screen, and it does not follow the pen tip when moving the pen across the display.

Make sure the Wacom driver has loaded properly by opening the Wacom Tablet control panel. If the driver did not load you will see an error message. If an error message appears, reboot your computer. If the problem persists, refer to [step 2: software installation](#) and reinstall the Wacom driver software. (For Mac, you must restart your computer after installing the Wacom driver for proper operation.)

If you have customized the side switch on your pen to toggle between pen mode and mouse mode, make sure that your pen display is operating in pen mode.



MULTI-TOUCH PROBLEMS



Multi-touch does not work.

Enable touch by pressing an ExpressKey that is set to TOUCH ON/OFF. Otherwise, open the Wacom Tablet control panel, click on the TOUCH icon, and go to the STANDARD GESTURES, MY GESTURES, or TOUCH OPTIONS tab. Be sure the ENABLE TOUCH option is selected.

Multi-touch does not seem to fully work. The screen cursor can be moved, but more complex actions or gestures do not work.

If the tablet driver does not load properly, basic touch movement will be recognized but other actions and gestures will not. Install the driver software.

The pen display does not reliably recognize multi-finger touch.

If you hold your fingers too close together, the pen display may not recognize them as being separate. Try moving your fingers a little further apart.

Cannot zoom-in or zoom-out when working with Adobe Photoshop.

If zoom functions do not operate correctly within Photoshop, verify that the ZOOM WITH SCROLL WHEEL function is not selected within the Photoshop PREFERENCES options.

Scrolling and panning gestures do not function correctly when working with Adobe Photoshop.

If touch gestures do not operate correctly within Photoshop, verify that the ZOOM WITH SCROLL WHEEL function is not selected within the Photoshop PREFERENCES options.

Rotation gestures do not seem to work consistently, or not at all.

Rotation may work differently depending on the application you are working with. For example, rotation may work smoothly, in 90-degree increments, or not at all.

For best recognition of this gesture, start with your fingers positioned diagonally on the tablet surface and keep them at least 25 mm (1 inch) apart.



WINDOWS-SPECIFIC PROBLEMS

You suspect the pen display preferences may be corrupted, or want to make certain that all settings are at their factory defaults.

Use the Wacom Tablet Preference File Utility to work with preferences. Close any open applications. Click the START icon and select ALL PROGRAMS. Then select WACOM TABLET and WACOM TABLET PREFERENCE FILE UTILITY.

- It is a good idea to first back up your tablet preferences. In the TABLET PREFERENCE FILE UTILITY dialog box, click BACKUP... and follow the prompts.
- Then use the Tablet Preference File Utility to delete the tablet preferences as follows:
 - Single user. Under MY PREFERENCES, click REMOVE to delete the preferences for the current user.
 - Multiple users. Under ALL USER PREFERENCES, click REMOVE to delete preferences for multiple users. Administrator rights are required to delete preferences for all users. Relaunch any currently open tablet-aware applications that you may be running.

You can quickly restore tablet preferences that have been backed up by clicking RESTORE... under MY PREFERENCES.

MAC-SPECIFIC PROBLEMS

At startup, a dialog box appears telling you that either the driver failed to load or the pen display preferences have not yet been created.

The tablet portion of the pen display was not detected at startup. Make sure the USB interface cable is securely connected to an active USB port on your computer or USB hub. Make sure that the pen display power LED is on and is glowing blue. If this does not correct the problem, see [troubleshooting](#).

From the GO menu, select UTILITIES and launch the SYSTEM PROFILER. Select USB from the HARDWARE section of the CONTENTS list. A Wacom USB pen display model should be listed. If a pen display model is not listed, check the pen display USB cable connection or try plugging the pen display into a different USB port.

If this does not help, contact Wacom for Technical Support. See [technical support options](#).

You suspect the pen display preferences may be corrupted, or want to make certain that all settings are at their factory defaults.

Use the Wacom Tablet Utility to work with preferences. Close any open applications. Open the main APPLICATIONS folder. Then open the WACOM TABLET folder and run the WACOM TABLET UTILITY.

- It is a good idea to first back up your tablet preferences. In the Wacom Tablet Utility, select CURRENT USER or ALL USERS. Then click BACKUP... and follow the prompts.

- Then, delete the tablet preferences as follows:

Single user. When the utility starts, select CURRENT USER and click REMOVE. Log out, then log back in. When the pen display driver loads it will create a new preferences file with the factory defaults.

Multiple users. When the utility starts, select ALL USERS and click REMOVE. Log out, then log back in. When the pen display driver loads it will create new preferences files with the factory defaults.

You can quickly restore tablet preferences that have been backed up for the CURRENT USER or ALL USERS by clicking RESTORE... within the utility.

Note: Do not manually remove the WACOMTABLET.PREFPANE file from the main LIBRARY PREFERENCEPANES folder. This file is only to be removed when uninstalling the Wacom software driver, and then only when using the Wacom Tablet Utility.

Recalibrate the pen display. See [calibrating the pen display](#).





Ink does not work correctly with the pen display.

There may be a problem with the Ink preferences. Remove the damaged preference files as follows. They will be re-created when you enable handwriting recognition.

1. Open SYSTEM PREFERENCES, choose SHOW ALL and select INK. Then turn off handwriting recognition.
2. From the GO menu, choose your HOME. Open the LIBRARY and PREFERENCES folders. Remove the following preferences:
 - COM.APPLE.INK.FRAMEWORK.PLIST
 - COM.APPLE.INK.INKPAD.PLIST
 - COM.APPLE.INK.INKPAD.SKETCH
3. Go back to SYSTEM PREFERENCES and INK, and then enable handwriting recognition.
4. Test the Ink function using your Wacom pen display and pen.

If this procedure does not resolve your problem with Ink, contact Apple Support for further assistance. Wacom is not the software manufacturer for Ink and we are limited in our abilities to support a third party software application.





TECHNICAL SUPPORT OPTIONS

If you have a problem with your Cintiq interactive pen display, first check the appropriate [installation](#) section in this manual to make sure the pen display is installed correctly. Then review the [troubleshooting](#) procedures.

If you cannot find the answer in this manual, you may find updated information about your problem in the Read Me file for your operating system (located on the Installation CD). You can also check the product FAQs ([Frequently Asked Questions](#)).

If you have an Internet connection, you can download the latest software drivers from the Wacom web site for your region. See [obtaining software updates](#).

Check the Customer Care options on the Wacom web site for your region. You may find answers to your questions without having to make a phone call.

If you cannot solve the problem and you think your Wacom product is not working properly, contact the Wacom support staff for the area where your product was purchased. See the Wacom Read Me file, located on the Installation CD, for contact information. You can also find contact information by checking the Wacom web site for your region.

When you call, you should be at your computer with the following information available:

- This manual.
- Pen display serial number. (See the label on the back of the pen display.)
- Driver version number. (See the Installation CD or click on the Wacom Tablet control panel ABOUT button.)
- The make and model of your computer, and operating system version number.
- The make, model, and connection type of your video card.
- A list of peripheral devices attached to your computer.
- The software application and version you were using when the problem occurred.
- The exact wording of any error message that appeared on your screen.
- What happened and what you were doing when the problem occurred.
- How you tried to solve the problem.

You can also contact the Wacom Customer Care Center by visiting the Wacom web site for your region and completing an Email Inquiry form.





OBTAINING SOFTWARE UPDATES

Wacom periodically updates the tablet software driver to maintain compatibility with new products. If you are having a compatibility problem between Cintiq and a new hardware or software product, it may be helpful to download a new software driver (when available) from the Internet.

Visit the Wacom web site at www.wacom.com for Customer Care and product drivers or other software updates.



FREQUENTLY ASKED QUESTIONS

This section provides answers to some of the more commonly asked questions about Cintiq. To browse more FAQs, visit the Wacom web site for your region.

[Will Cintiq work in all applications?](#)

[What software applications support Cintiq features?](#)

[Can I have Cintiq and a mouse connected to my computer at the same time?](#)

[Can I use older Wacom input tools with Cintiq?](#)

[Do I need to install the software driver to work with multi-touch?](#)

[The installer is asking for a password. What is the password?](#)

[The pen and screen cursor do not line up. Why?](#)

[How do I reset my Cintiq preferences to the default settings?](#)

[Can I delete all Cintiq preferences at one time?](#)

[What is the best way to clean Cintiq?](#)

[How do I change the nib \(tip\) of my pen?](#)

[Where can I obtain spare parts and accessories?](#)

[How do I find the product model and serial number?](#)

Will Cintiq work in all applications?

Cintiq supports general mouse input functions in all applications. Assuming the product driver is installed and functioning properly, pressure sensitivity and eraser functions are also supported in many graphic applications.

What software applications support Cintiq features?

Many applications support pressure sensitivity and eraser input from your Wacom product.

Visit www.wacom.com and search software applications. If you do not find your application listed, try using it with Cintiq to determine if you experience pressure variance when you paint or draw with the pen. Your software manufacturer will be able to provide the best information about which pen input features the application supports.

Can I have Cintiq and a mouse connected to my computer at the same time?

Yes. You can use your system mouse in conjunction with your Wacom product. Only one device at a time can control the screen cursor. You can change back and forth between your Cintiq input tools and a system mouse at your convenience.





Can I use older Wacom input tools with Cintiq?

Pens and accessories are generally specific to the product model they come with, so they may not be interchangeable. Visit the Wacom web site for your region and check the Customer Care Knowledge Base for details.

Do I need to install the software driver to work with multi-touch?

Yes. You must install the software driver before you can use multi-touch gestures on your Cintiq 24HD touch.

The installer is asking for a password. What is the password?

The computer is looking for a password that is either your personal password or the administrative password to log into the computer. If your personal password does not work and you are in a business environment you will need to ask the system administrator to install the tablet for you. The operating system requires the user to have administrative access to install a hardware device.

The pen and screen cursor do not line up. Why?

The interactive pen display needs to be calibrated. This should be done each time you reinstall the tablet driver or delete the Cintiq preference file. See [calibrating the pen display](#).

How do I reset my Cintiq preferences to the default settings?

See [managing preferences](#).

Can I delete all Cintiq preferences at one time?

Yes. See [managing preferences](#).

What is the best way to clean Cintiq?

See [caring for Cintiq](#).

How do I change the nib (tip) of my pen?

See [replacing the pen nib](#).

Where can I obtain spare parts and accessories?

See [ordering parts and accessories](#).

How do I find the product model and serial number?

These are labeled on the back of the Cintiq interactive pen display. The model number is typically located above the bar code, and the serial number just below the barcode. The model number and serial number is needed for all Customer Care support requests.



CARE AND MAINTENANCE

This section provides tips for the care and maintenance of your Cintiq 24HD interactive pen display.

[Caring for Cintiq](#)

[Replacing the pen nib](#)

CARING FOR CINTIQ

Keep the Grip Pen and the Cintiq LCD screen surface clean. Dust and dirt particles can stick to the pen and cause excessive wear to the display screen surface. Regular cleaning will help prolong the life of your LCD screen surface and pen.

Keep Cintiq, the Cintiq display stand, and the Grip Pen in a clean, dry place and avoid extremes in temperature. Room temperature is best.

Cintiq, the display stand, and the Grip Pen are not made to come apart. Taking apart the product will void your warranty.

Important: Take care to never spill liquids onto the pen display or pen. Be especially careful of getting the display, ExpressKeys, Touch Rings, or pen buttons and tip wet as they contain sensitive electronic parts that will fail if liquids enter them.

Prevent scratching by replacing your pen nibs frequently. When the nibs are worn or pointed they can damage your pen display. See [replacing the pen nib](#).

To clean the Cintiq casing, the Cintiq display stand, or the Grip Pen, use a soft, damp cloth; you can also dampen the cloth using a very mild soap diluted with water. Do not use paint thinner, benzine, alcohol, or other solvents to clean the product casing or pen.

To clean the display screen, use an anti-static cloth or a slightly damp cloth. When cleaning, apply only a light amount of pressure to the display screen and do not make the surface wet. Do not use detergent to clean the display screen; this may damage the pen display screen. Damage of this kind is not covered by the manufacturer's warranty.

REPLACING THE PEN NIB



To protect your pen display from scratching and for best performance, periodically replace your pen nibs.

Important: Replace the pen nib before or when it looks like this:

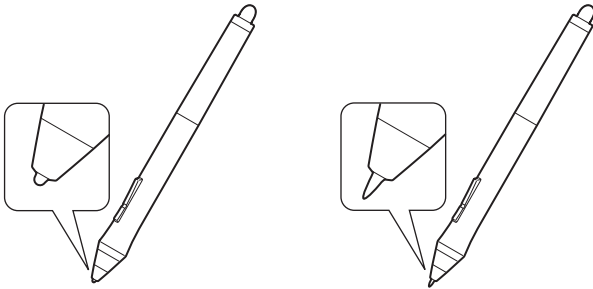

The pen nib (tip) will wear with normal use.

Excessive pressure will cause it to wear sooner.

Replace the nib when it gets too short or develops a flat point.

1. Unscrew the pen stand base to access the nib removal tool and replacement nibs.

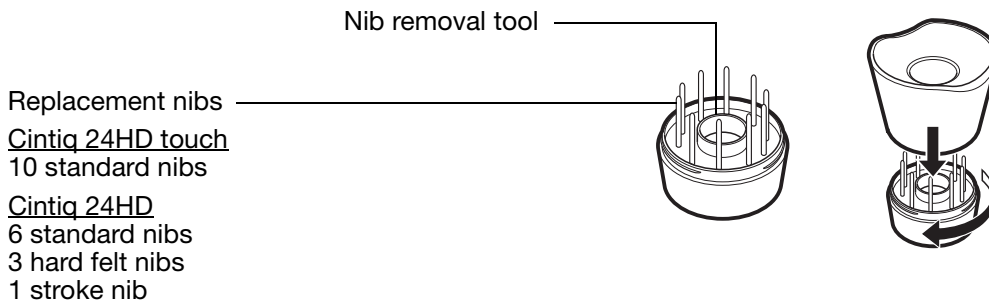

2. Clasp the old nib and pull it straight out of the pen. Use the nib removal tool, pair of tweezers, needle-nosed pliers, or similar instrument.





3. Slide the end of the new nib straight into the barrel of the pen. Firmly push the nib until it stops.

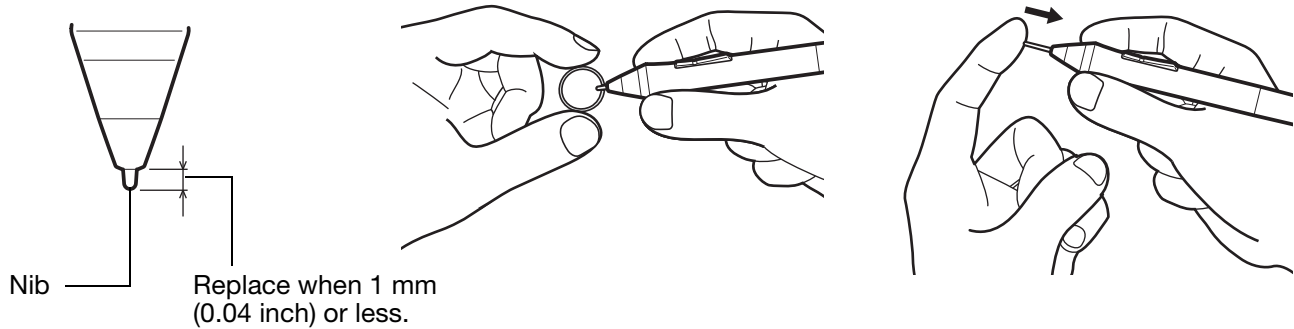

 **Warning**

Choking hazard. Prevent children from swallowing the pen nib or side switch. The pen nib or side switch may accidentally be pulled out if children are biting on them.

For replacement parts, see [ordering parts and accessories](#).

Important:

- When not in use, place the pen in the pen stand or lay it flat on your desk.
- When the optional Airbrush is not in use, lay it flat on your desk.
- To maintain the sensitivity of your input tools, do not store them in a container where they will rest on their tip or eraser. Improper storage may damage the pen tip pressure sensor(s).





OTHER USEFUL INFORMATION

This section includes instructions on how to manage your Cintiq preferences, uninstall the product software, and more.

[Removing Cintiq from the display stand](#)

[Mounting Cintiq on the display stand](#)

[Using an alternate mount or stand](#)

[Uninstalling Cintiq](#)

[Managing preferences](#)

[Installing multiple tablets](#)

[Using applications integrated for tablet control](#)

[Importing expert settings](#)

[Pen and digital ink capabilities in Windows](#)

[Product information](#)

[Ordering parts and accessories](#)

[Available parts and accessories](#)





REMOVING CINTIQ FROM THE DISPLAY STAND

The Cintiq interactive pen display has been specifically designed for use when mounted on the Cintiq display stand. However, there may be times when it will be necessary to remove the pen display from the stand. For example, you may want to locate the pen display on a suitable VESA mounting arm. See [using an alternate mount or stand](#).

Important: Request assistance from another person when removing Cintiq from the stand. Cintiq is heavy. Use care when working with or moving the unit.

To remove the pen display from the stand:

1. First disconnect all cables from between the display stand and your computer. Then move Cintiq to a location with adequate space for disassembly.

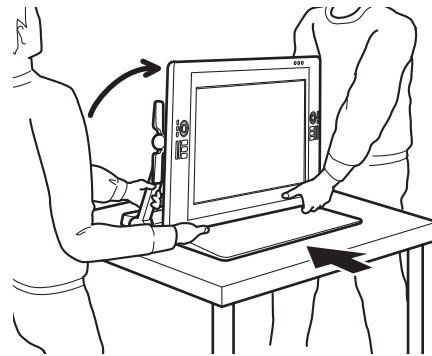
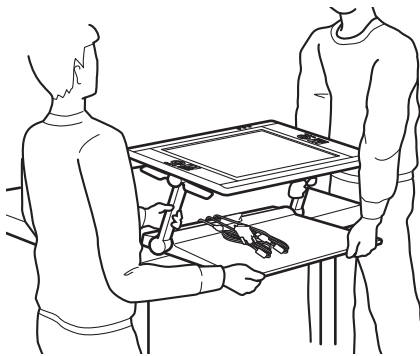

- [Adjust height and incline](#) so the display stand support arms are locked upright, with Cintiq positioned horizontally. Place all cables on top of the stand base and ensure they do not hang free. Tripping over loose cables can cause physical damage or personal injury.
- Request assistance from another person or persons. Each person should securely grasp the lower part of a display support arm near the display stand base. With the other hand, grasp the base of the stand at the front corner. Using care, lift and carefully move this product while supporting the base of the stand.

Important: The assembly is heavy. Do not attempt to lift Cintiq by yourself. Each person should use both hands to securely grasp the product. Grasp the stand base at the corner areas to avoid any sharp edging. DO NOT lift the pen display itself, otherwise damage might occur to the LCD if it flexes during movement. Also, the pen display does not have sufficient strength to support the load of the stand hanging freely from it. Work together, and lift carefully.

- Locate Cintiq on a desktop or other working surface that is flat, clean, and free of any moisture or oily film. Taking care not to pinch your fingers, do this by first placing the rear half portion of the stand onto the table surface. Then slide the stand fully into place so that it will not tip or fall.
- When in place, use the incline levers to rotate the display back to a vertical position.



2. Prepare the pen display. Adjust height and incline so that both display support arms are in their upright, locked position. The pen display incline should be approximately 45 degrees to the stand base. As a unit, carefully pivot Cintiq and the display stand on the stand base edge so the display can be placed face down on a soft cloth or other protective surface.

Carefully adjust the incline levers until the pen display screen lies flat on your work surface. This also allows for access to the display support arm brackets. Correct placement will have the base of the stand aligned on edge near the bottom of the pen display.

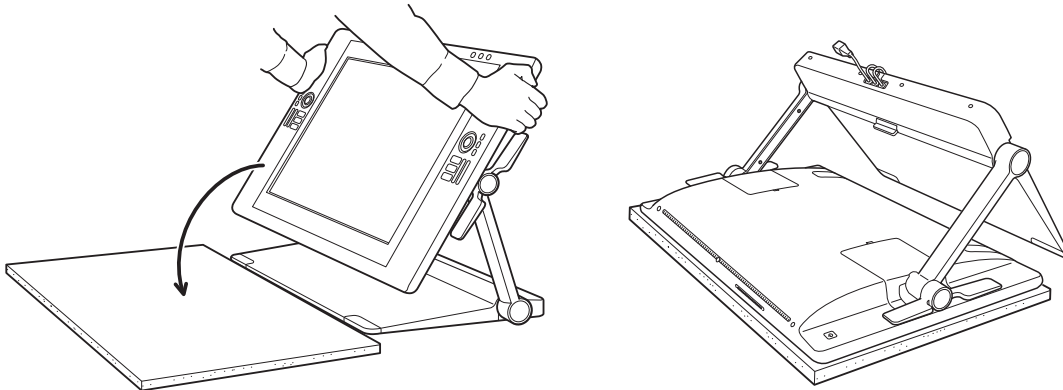

 **Warning**

Do not allow the pen display to drop onto the work surface. Avoid catching your finger in the gaps of the movable portions of the stand.

3. Ready the stand for removal. Remove the cable connector covers from the back of the pen display. Disconnect the cables.

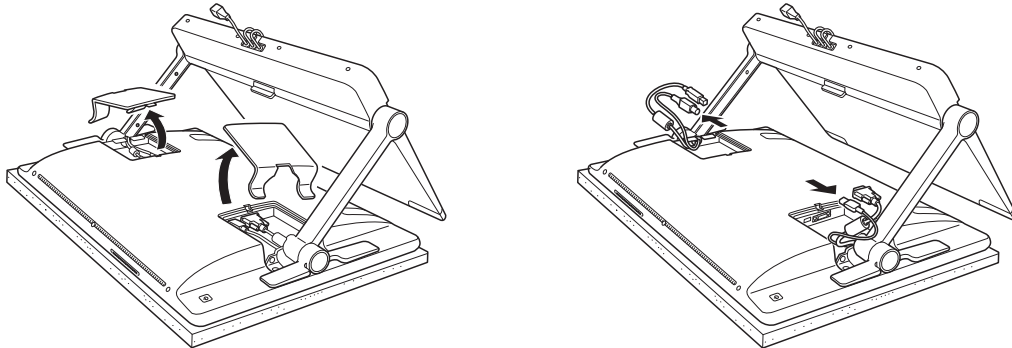

4. If using the connection cables in a different mounting configuration, properly remove them from the display stand. See [cable replacement](#).
5. Remove the screws that secure the support arm brackets to the pen display. There are 4 Phillips screws per bracket. Save these screws for future use.

Mounting brackets

Brackets fix Cintiq to the display stand. Cintiq should remain mounted on the stand, except when a specialized mounting fixture is required.

Screw type: Phillips, flat fillister head, M3-6, black

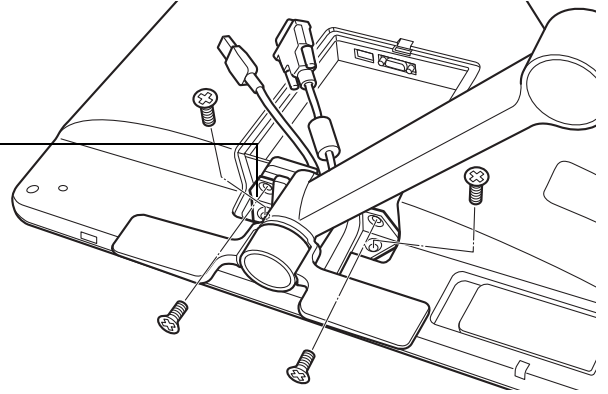

Warning

Do not operate the incline levers unless the display support arms are roughly located within their mounting brackets and you are placing some amount of leverage on the support arms to hold them in place.

The incline levers are spring-loaded and may cause injury or damage if released without weight on the stand support arms. Improper operation may lead to physical injury or damage to the stand. Avoid catching your finger in the gaps of the movable portions of the stand.

6. Lift the stand away from the pen display.

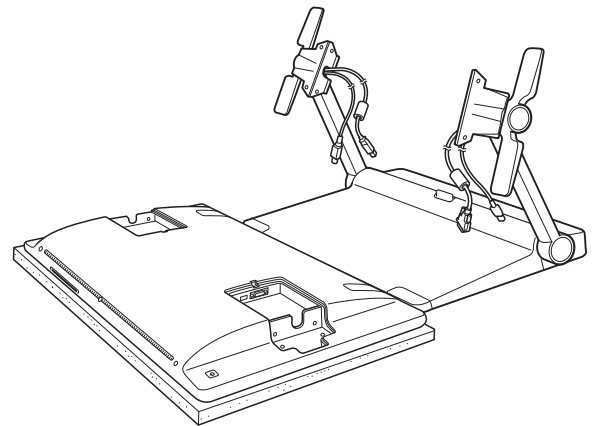
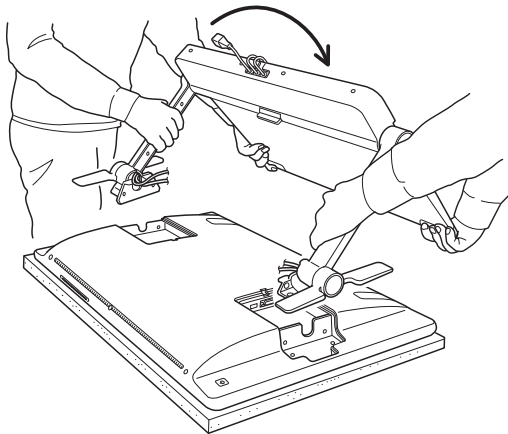

7. If you will be using the interactive pen display in an installation that requires the use of an alternate mounting platform, see [using an alternate mount or stand](#). Always replace the cable connector covers on the back of the pen display.

MOUNTING CINTIQ ON THE DISPLAY STAND

Follow the below procedure to mount the interactive pen display on the display stand. For example, Cintiq may have been mounted in a specialized location using a suitable VESA mounting arm and you now wish to return the pen display to the display stand.

Important: Request assistance from another person when mounting Cintiq on the stand. Cintiq is heavy. Use care when working with or moving the unit.

To mount the pen display on the stand:

1. Prepare the display stand. Carefully raise both display support arms to their upright, locked position.
2. Prepare the pen display. Place the pen display face down on a soft cloth or other protective surface. Remove both cable connector covers from the pen display, if you have not already done so.

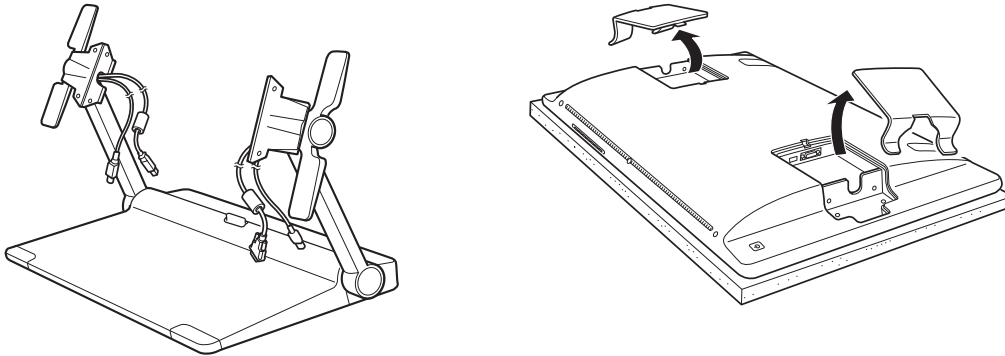

3. Ready the stand for attachment. Locate the base of the stand so the edge is aligned near the bottom of the pen display.
4. Pivot the stand on its base edge. The connection cables port and release latch should rise above the table surface. Continue pivoting the stand to lower the support arm brackets into the bracket mounts located on the pen display.

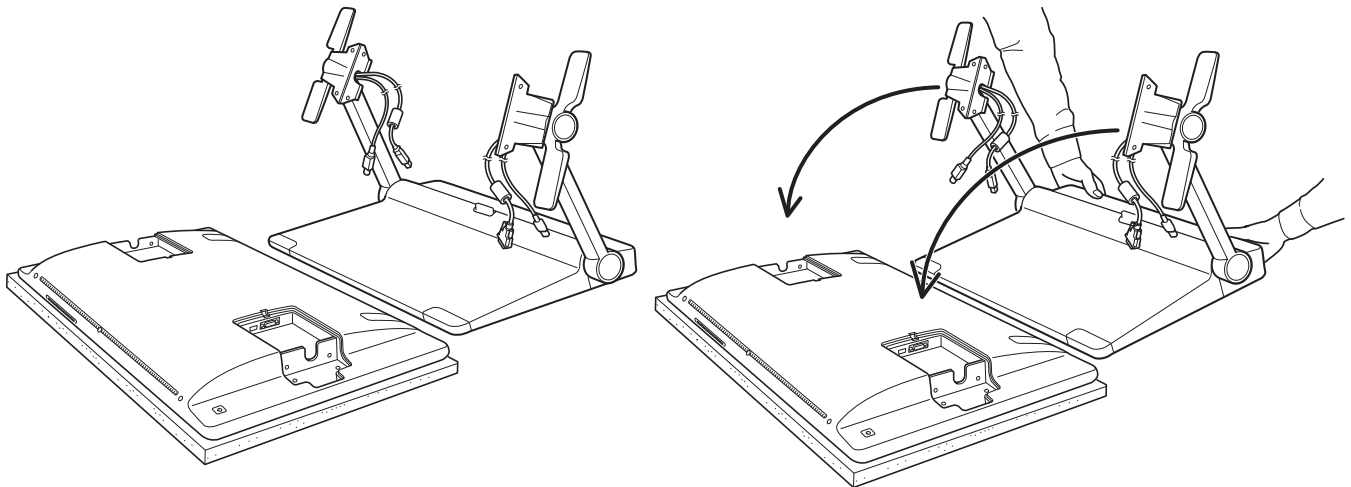



5. Adjust the [incline levers](#) as needed for a proper, flush fit on both arm brackets. Use the appropriate mounting screws that came with your product to secure the support arm brackets to the pen display. There are 4 Phillips screws per support arm bracket. Do not overtighten or strip the screw threads.

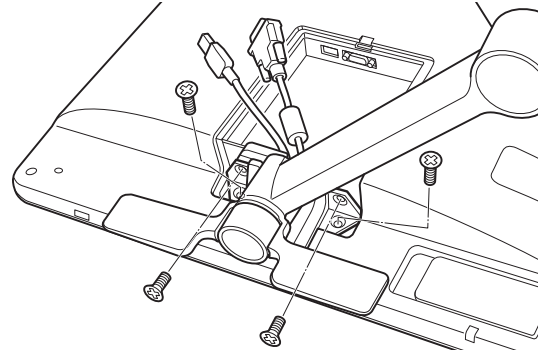
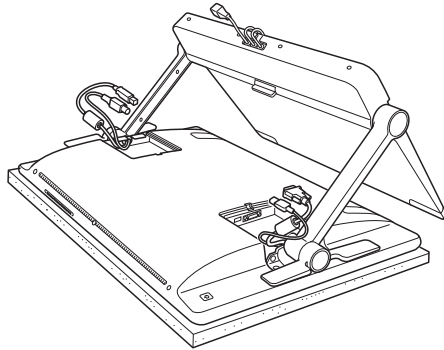

 Warning

Do not operate the incline levers unless the display support arms are roughly located within their mounting brackets and you are placing some amount of leverage on the support arms to hold them in place.

The incline levers are spring-loaded and may cause injury or damage if released without weight on the stand support arms. Improper operation may lead to physical injury or damage to the stand. Avoid catching your finger in the gaps of the movable portions of the stand.

6. Set the assembled unit on the stand base. Check for stability of the support arms. Carefully move the pen display and stand through their full range of motion. See [adjusting display height and incline](#).



7. After you have ensured the pen display is properly mounted and that the stand operates smoothly, then move Cintiq to your desired work location.

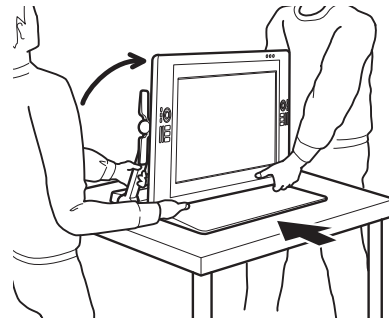
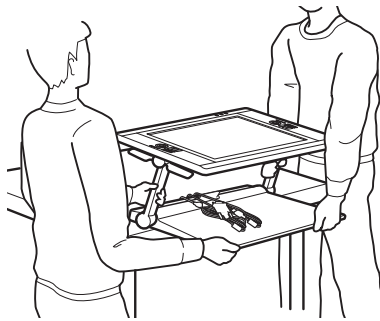

- [Adjust height and incline](#) so the display stand support arms are locked upright, with Cintiq positioned horizontally. Place all cables on top of the stand base and ensure they do not hang free. Tripping over loose cables can cause physical damage or personal injury.
 - Request assistance from another person or persons. Each person should securely grasp the lower part of a display support arm near the display stand base. With the other hand, grasp the base of the stand at the front corner. Using care, lift and carefully move this product while supporting the base of the stand.
Important: The assembly is heavy. Do not attempt to lift Cintiq by yourself. Each person should use both hands to securely grasp the product. Grasp the stand base at the corner areas to avoid any sharp edging. DO NOT lift the pen display itself, otherwise damage might occur to the LCD if it flexes during movement. Also, the pen display does not have sufficient strength to support the load of the stand hanging freely from it. Work together, and lift carefully.
 - Locate Cintiq on a desktop or other working surface that is flat, clean, and free of any moisture or oily film. Taking care not to pinch your fingers, do this by first placing the rear half portion of the stand onto the table surface. Then slide the stand fully into place so that it will not tip or fall.
 - When in place, use the incline levers to rotate the display back to a vertical position.
8. If the connection cables were previously removed from the stand, properly relocate them. See [cable replacement](#). Properly connect the cables to the pen display and replace the connector covers.



USING AN ALTERNATE MOUNT OR STAND

If using Cintiq in an installation that requires the use of an alternate mounting platform, you can remove the Cintiq display stand from the pen display and mount the display onto any stand or mounting platform conforming to the VESA MIS-E 100/200 (6 screw) standard.

Notes:

Required mounting screws are 4 mm wide with a 0.7 mm pitch (M4), with a screw clearance depth of 17 mm. Exceeding the clearance depth of 17 mm will damage the internal components of the pen display. These screws were provided with your product accessories.

The combined weight of this product (pen display and display stand) is approximately 29 kg (64 lbs). Any table or platform on which this product is installed must be able to support the combined weight of the Cintiq interactive pen display and Cintiq display stand.

The pen display portion of this product weighs 16 kg (35.2 lbs). Any platform or fixture on which the pen display alone is mounted must be able to support the weight of the Cintiq interactive pen display.

To remove the pen display from the display stand:

1. Turn off your computer and power off the pen display.
2. See [removing Cintiq from the display stand](#).

To attach the pen display to a VESA mount:

1. Review the instructions that came with your stand or mounting platform. Be sure you understand them, and follow all instructions carefully. Pay attention to any cautions or other safety information.
2. Locate the provided VESA mount spacers to match the lower three screw positions on the back of Cintiq.
3. Using the appropriate screws for your mounting platform and as indicated above, firmly attach the pen display to the platform.
4. As applicable, attach the appropriate cabling between the pen display and your computer. Be sure to replace the pen display cable connector covers.

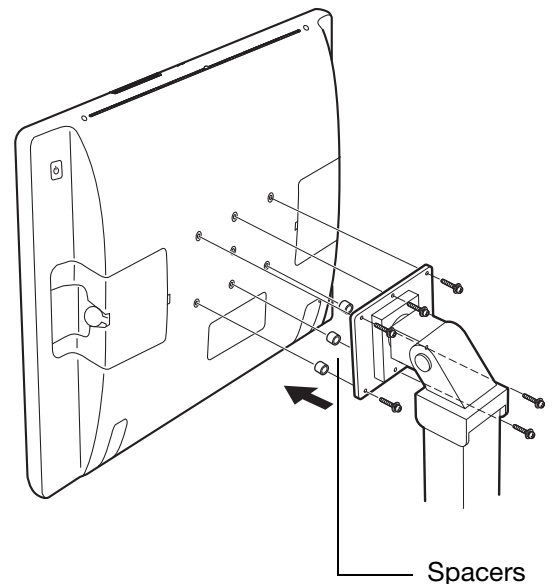

To remove the pen display from a VESA stand, reverse the above procedure. Then see [mounting Cintiq on the display stand](#).

Warning

When attaching the pen display onto an alternate mounting platform, be sure to follow all instructions in the documentation supplied by the platform manufacturer. If improperly installed, the pen display could fall, resulting in physical injury or damage to the product.





UNINSTALLING CINTIQ

Follow the appropriate procedure below to remove the Wacom driver software and the Cintiq interactive pen display from your system.

Important: When you remove the Wacom driver software, your interactive pen display will no longer operate with full tablet functionality but will continue to function as a mouse device.

Windows:

1. Click on the Windows START button and open the CONTROL PANEL.
2. In the CONTROL PANEL window for
 - Windows 7 and Vista: click on UNINSTALL A PROGRAM. In the dialog box that appears, choose WACOM TABLET and click UNINSTALL.
 - Windows XP: select ADD OR REMOVE PROGRAMS. In the ADD OR REMOVE PROGRAMS window, choose WACOM TABLET and click REMOVE.
3. Follow the prompts to remove the software driver. If prompted, enter your administrator log on name and password.
4. When the driver has been removed, shut down your system, power off your computer, and turn off the pen display. When your computer and pen display are off, disconnect the pen display from your computer.

Note: The Cintiq 24HD touch does not support operation on Windows Vista or XP systems.

Mac:

1. From the GO menu, choose APPLICATIONS and open the WACOM TABLET folder.
2. Double-click on the WACOM TABLET UTILITY icon. Click on the TABLET SOFTWARE: REMOVE button. Enter your administrator log on name and password.
3. After the removal is completed, click OK.
4. Shut down your computer and turn off the pen display. When your computer and pen display are off, disconnect the pen display from your computer.

See [obtaining software updates](#) for information on downloading a new software driver (when available) from the Internet.





MANAGING PREFERENCES

Use the Wacom tablet preferences utility to manage your pen display preferences for single or multiple users.

Windows: First close any open applications. Then open the utility by clicking the START icon and selecting ALL PROGRAMS. Select WACOM TABLET and WACOM TABLET PREFERENCE FILE UTILITY.

- To remove preferences for the current user, click REMOVE under MY PREFERENCES.
- To delete preferences for multiple users, click REMOVE under ALL USER PREFERENCES. Administrator rights are required to delete preferences for all users. Relaunch any currently open tablet-aware applications that you may be running.
- To back up your preferences, click BACKUP... under MY PREFERENCES.
- To restore preferences that you had previously backed up, click RESTORE... under MY PREFERENCES.
- Carefully follow any prompts that may appear.

Mac: Open the main APPLICATIONS folder. Then open the WACOM TABLET folder and run the WACOM TABLET UTILITY.

- To remove preferences, select CURRENT USER or ALL USERS. Then click REMOVE. Log out, then log back in. When the software driver loads it will create a new preferences file with the factory defaults.
- To back up your preferences, select CURRENT USER or ALL USERS. Then click BACKUP....
- To restore preferences that you had previously backed up, select CURRENT USER or ALL USERS. Then click RESTORE....
- Carefully follow any prompts that may appear.



INSTALLING MULTIPLE TABLETS

Any pen display or tablet that has been detected on your system will appear as an icon within the Wacom Tablet control panel TABLET list.

Select a pen display or tablet icon for which to customize tool and application settings.

- The control panel will not launch unless a supported pen display or tablet is connected to the computer.
- Settings can only be viewed or changed for an attached pen display or tablet.

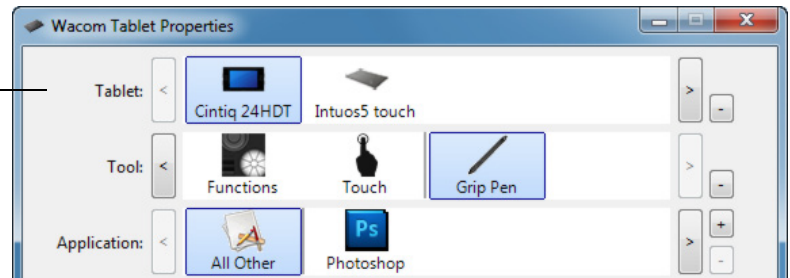

To add a new pen display or tablet, connect it to your computer. The system will automatically find the pen display or tablet and initialize it. An icon for the pen display or tablet will then appear in the control panel.

Important: When installing additional pen display units or tablets on Windows systems, the eraser function may not work in some applications when using the additional pen display(s) or tablet(s). The eraser function will continue to work correctly using the first pen display or tablet that was added to the control panel.

To remove one of multiple pen displays or tablets from the driver, select the pen display or tablet to be deleted and click on the [-] button next to the TABLET list.

- A pen display or tablet must be attached to the computer before it can be deleted from the control panel list.
- You will need to restart your computer before you can again add the tablet to the driver.

USING APPLICATIONS INTEGRATED FOR TABLET CONTROL

Some software applications may be designed to directly control ExpressKey or Touch Ring functions. When working in an application that has been integrated in this manner, the ExpressKeys or Touch Rings may perform differently than the function that is set in the Wacom Tablet control panel.

- When an ExpressKey is overridden by an application, the ExpressKey setting will automatically update, using either “Application Defined” or the new function name. Some or all of the ExpressKeys may be overridden, depending on the application.
- When an application overrides a Touch Ring, all Touch Ring functions are affected. If an application overrides only some of the available Touch Ring functions, the remaining function(s) are set to SKIP.
- An integrated application will control the ExpressKeys or Touch Rings only when that application is active and in the foreground. When you close the application or select a new application pane to work in, your Wacom Tablet control panel settings are returned to their previous state.
- To review ExpressKey, Touch Ring, or pen function settings for the current front-most application, set an ExpressKey to SETTINGS and press the key at any time.

Applications that have been integrated in this manner will typically provide you with the opportunity to opt-out or disable this functionality when first using your Wacom product with the application. See the documentation provided with your application for any specific details on functionality and how to customize or disable this feature.

If an automatic prompt or the application’s documentation do not describe how to disable this behavior, you can use the Wacom Tablet control panel to create [application-specific settings](#) that will override the behavior of the integrated application. See also [managing preferences](#).

Important: If an application-specific setting has been created for an integrated application, setting an ExpressKey or Touch Ring function to APPLICATION DEFINED will still allow the integrated application to control the function.

IMPORTING EXPERT SETTINGS

The import expert settings feature enables you to import customized Wacom Tablet control panel settings that have been specified in an XML (Extensible Markup Language) file.

- Some software developers may create custom settings files which are specifically designed to provide optimum performance when using your Wacom product with their applications.
- Visit the Wacom web site for your region to choose from a variety of custom settings files that may be available for your product.
- Each XML file may include customized settings for one or more applications. These settings may apply to the ExpressKeys, Touch Rings, Radial Menu, or pen button and eraser functions.

To import expert settings:

1. Choose an XML file with settings for use with a particular application. Double-click on your file selection.
2. Carefully read and follow the instructions in the confirmation dialog.
 - The utility will import settings for one or more applications. Any previous settings for those applications may be overridden.
 - You are encouraged to back up any existing control panel settings before importing the expert settings.
 - You can cancel, or continue to import the settings.
3. When you choose to import settings, only the settings specified in the XML file will be imported. Any corresponding settings will be overridden with the new values. All other existing settings will remain unchanged.

After the import process is completed you will have an opportunity to view the new settings within the Wacom Tablet control panel.

PEN AND DIGITAL INK CAPABILITIES IN WINDOWS



Microsoft Windows 7 and Vista provide extensive support for pen input. Pen features are supported in all versions of Windows 7 and Vista except Windows 7 Starter and Home Basic, and Windows Vista Home Basic. Use Cintiq and your Wacom pen for quick, intuitive results.

Note: The Cintiq 24HD touch does not support operation on Windows Vista systems.

- **Note taking.** Jot notes and capture quick sketches in Windows Journal. Use the Journal search engine to locate your handwritten content.
- **Handwriting recognition.** Quickly enter handwritten information anywhere the computer accepts typed input. Convert your handwritten content to typed text at any time.
- **Gestures.** Make simple gestures on the pen display to trigger customizable actions. To customize gestures, select the FLICKS tab in the Windows 7 PEN AND TOUCH or Windows Vista PEN AND INPUT DEVICES control panel.
- **Digital Ink in Microsoft Office 2007 and 2010.** Utilize the enhanced digital mark-up and inking tools found on the REVIEW tab within applicable applications.

The Windows 7 or Vista Input Panel enables you to use handwriting or an on-screen keyboard to directly enter text with your Wacom pen.

There are different ways to launch the Input Panel:

- Click on the Input Panel icon which appears when you move the screen cursor into a text entry area.
- Click on the Input Panel tab, located by default on the left edge of the display screen.
- Click on the Tablet PC Input Panel icon located on the Windows Taskbar. If the icon is not visible, right-click on the Taskbar, select TOOLBARS, and TABLET PC INPUT PANEL.

To disable the Input Panel:

1. Open the Tablet PC Input Panel.
2. Select TOOLS and OPTIONS.
3. Choose the OPENING tab and uncheck the following boxes:
 - FOR TABLET PEN INPUT, SHOW THE ICON NEXT TO THE TEXT BOX
 - SHOW THE INPUT PANEL TAB.
4. Click OK.

For details, study the documentation that came with your system, including the Windows training tools and Tablet PC tutorial. To access the Tablet PC Pen Training, from the START menu choose ALL PROGRAMS, TABLET PC, and TABLET PC PEN TRAINING. Search the Windows help system for training tools if they are not available from the START menu.





Search the Microsoft web site for enhanced information about digital inking in Windows. You can also visit the Wacom web site at www.wacom.com and search digital inking in Windows.

Note: The following workarounds in the Wacom software driver improve performance in Windows 7 and Vista:

- The Pen Flicks and 'press-and-hold-to-right-click' features are disabled in graphics applications using the Wintab API.
- There is no pressure sensitivity in Journal and other Ink features when both the Flicks and 'press-and-hold-to-right-click' features are disabled in the Windows 7 PEN AND TOUCH or Windows Vista PEN AND INPUT DEVICES control panel.

PRODUCT INFORMATION

To learn more about your Cintiq, visit the Wacom web site for your region. You can also discover which software applications are currently tablet enhanced to support the pressure sensitivity and other special functionality of your pen display by searching software applications.

USA, Canada, Central and South America	http://www.wacom.com
Europe, Middle East and Africa	http://www.wacom.eu
Japan	http://wacom.jp
Asia Pacific (English)	http://www.wacom.asia
China (Simplified Chinese)	http://www.wacom.com.cn
Hong Kong (Traditional Chinese)	http://www.wacom.com.hk
Korea	http://www.wacom.asia/kr
Taiwan	http://www.wacom.asia/tw
Thailand	http://www.wacom.asia/th





ORDERING PARTS AND ACCESSORIES

To purchase [available parts and accessories](#), refer to the Wacom pen display Read Me file and see who to call for your region.

You can also do the following:

- In the USA or Canada, call 1.888.884.1870 (toll-free) or visit Wacom's web site at <http://direct.wacom.com> (USA only).
- In Europe, call +49 (0)180.500.03.75 or send an email to spareparts@wacom.eu. Or, visit <http://shop.wacom.eu>. You can also contact your local dealer, distributor, or technical support using the appropriate number for your region.
- In Australia, Singapore, Taiwan and Korea, please visit: www.BuyWacom.com.au, www.BuyWacom.com.sg, www.BuyWacom.com.tw and www.BuyWacom.co.kr, respectively.
- In other countries, please contact your local dealer or distributor.

Some parts and accessories may not be available in all regions.

AVAILABLE PARTS AND ACCESSORIES

For a list of available parts and accessories, visit the Wacom web site for your region. See [ordering parts and accessories](#).



GLOSSARY

Active area. The area of the pen display where multi-touch or your Cintiq tools are detected. See [touch sensor](#).

Application-specific settings. Cintiq tool and tablet settings that have been customized for individual applications. The Wacom Tablet control panel enables you to customize a tool to behave uniquely in different applications. [Application-specific settings](#) are in effect whenever you use the application.

Aspect. The ratio between the vertical and horizontal dimension of the active area on the pen display.

Click force. The amount of force you must apply to the pen tip for a click to occur.

Double-click assist. A function of the Wacom Tablet control panel that makes it easier to double-click by setting the size of the double-click distance.

Double-click distance. The maximum distance (in screen pixels) that the screen cursor can move between clicks and still be accepted as a double-click. Increasing the double-click distance makes double-clicking easier, but may cause a delay in brush strokes in some graphics applications.

Eraser-aware application. A software application that has built-in support for the pen eraser. These applications take advantage of the eraser in different ways, depending on what makes sense for the application.

Expand. A motion used when [navigating with multi-touch](#). Touch the pen display surface with two fingers spaced closely together. Then while still touching the display surface, move your fingers apart.

ExpressKeys. The customizable control keys located on the pen display. See [using the ExpressKeys](#).

Fingerwheel. The control wheel on the optional Airbrush.

Hardware control buttons. The function buttons located on the pen display. See [using the hardware control buttons](#).

Journal. A Microsoft Windows application that electronically simulates a physical journal pad, but with the advantages of digital note taking. For example, you can create quick sketches and jot handwritten notes that can be converted to text and sent on to colleagues for digital mark-up. Journal includes a variety of pen, marker, and highlighter tools, plus an eraser that is easily activated by the eraser end of your Wacom pen. Additionally, your handwritten content is searchable within Journal.

LED. Light-Emitting Diode. Used as pen display indicator light(s).

Modifier. Modifier keys include SHIFT, ALT, and CTRL for Windows, or SHIFT, CONTROL, COMMAND, and OPTION for Mac. You can customize your Cintiq tool buttons or ExpressKeys to simulate a modifier key.



Mouse acceleration. A setting that allows you to adjust the screen cursor acceleration when using mouse mode.

Mouse mode. A method for positioning the screen cursor. When you place a Cintiq tool on the tablet, you can move the screen cursor with a “pick up and slide” motion similar to using a traditional mouse. This is known as relative positioning. See also [pen mode](#).

Mouse speed. A setting that allows you to adjust the speed at which your screen cursor moves when using mouse mode.

Multi-touch. The ability to use multi-finger gestures on the interactive pen display.

Navigate. A motion used when [navigating with multi-touch](#). The screen cursor jumps to the position where you touch the display screen surface.

Nib. The replaceable pen tip.

Pan. A motion used when [navigating with multi-touch](#). Touch the pen display surface with your fingers and move them in the same direction.

Parallax. The angular distortion of an object’s position when viewed through glass or other medium. You must calibrate the pen display to compensate for this effect, and to align the screen cursor with the position of the pen on the display screen.

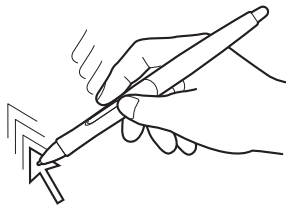

No parallax. The pen tip and screen cursor are aligned.

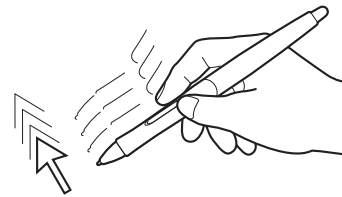

Parallax effect caused by display screen glass. Note how the position of the pen tip and screen cursor are not aligned.

Pen input. A method of controlling a computer using the pen on your interactive pen display.

Pen mode. A method of positioning the screen cursor. Wherever you place your Cintiq pen on the pen display tablet, the screen cursor will jump to the corresponding point on the screen. This is known as absolute positioning, and is the default setting for the pen. Pen mode allows you to quickly position the screen cursor without having to first find it and then move it across the desktop. See also [mouse mode](#).

Pinch. A motion used when [navigating with multi-touch](#). Touch the pen display surface with two fingers spaced slightly apart. Then while still touching the display surface, move or ‘pinch’ your fingers together.

Pixel. The smallest unit of measure on your display screen.

Pressure sensitive. A quality of the Wacom pen tip and eraser that senses the amount of pressure being applied. This is used to create natural-looking pen, brush, and eraser strokes in applications that are pressure sensitive.





Pressure-sensitive application. Any application that supports pressure-sensitive input.

Proximity. The height above the pen display [active area](#) where pen detection occurs. See also [pen features](#).

Radial Menu. A hierarchical menu (in radial format). Each level of the menu consists of eight menu slices which may contain various features and options to choose from. You can customize the buttons of your input tools or Cintiq to display this menu.

Rotate. A motion used when [navigating with multi-touch](#). Touch the pen display surface with two fingers spaced slightly apart and move (rotate) them in a circular fashion, or move them in opposing directions. Alternatively, hold one finger stationary and move your other finger around the stationary finger.

Screen cursor. The pointer on the display screen. Screen cursors come in different shapes (such as an I-beam, arrow, or box), depending on which application you are running.

Swipe. A motion used when [navigating with multi-touch](#). Touch the pen display surface with three, four, or five fingers and move them in the same direction.

Tablet PC Input Panel (TIP). The Microsoft Windows Tablet PC Input Panel enables you to use your Wacom pen to create handwritten notes or work with an on-screen keyboard. The Input Panel dynamically converts your handwriting to text. The information you create can then be inserted into other documents, spreadsheets, or illustrations.

Tap. A motion used when [navigating with multi-touch](#). Touch and lift a single finger (or multiple fingers, depending on the gesture) from the pen display surface.

Tilt sensitive. A quality of the pen tip and eraser that senses the amount of tilt between the tool and tablet. This is used to create natural-looking pen, brush, and eraser strokes in applications that are tilt sensitive.

Touch. A method of interacting with a computer using finger tip gestures on the interactive pen display screen surface.

Touch Rings. The customizable control rings located on the pen display. See [using the Touch Rings](#).

Touch sensor. Cintiq 24HD touch only. The navigation area where touch is detected.

USB. Universal Serial Bus. A hardware interface standard for connecting computer peripheral devices. USB ports support hot-plugging, which allows you to connect or disconnect a USB device without turning off your computer.

Wintab. An interface standard used by Windows applications for receiving tablet information. Cintiq supports all Wintab-compatible applications under Windows.





INDEX

About the manual	5	Clicking, with pen	36
Accessories		Control panel	
available	152	lists	88
ordering	152	manage settings	86
Adding a new tool	109	opening	86
Adjusting, pen display	46	overview	87
Applications, integrated for tablet control	148	tabs	88
Application-specific settings		Controls, testing	114
changing settings	108	Customizing	85
creating	107	eraser feel	92
removing	108	ExpressKeys	95
working with	106	multi-touch	
Auto-sync	46	custom functions	82
Box		standard functions	81
contents	8	pen	90
unpacking	6	pen display functions	94
Button functions	97	Radial Menu	104
Cables, replacement	28	tilt sensitivity	94
Calibrating, pen display	89	tool buttons	93
Care and maintenance	134	Touch Rings	96
Cintiq		Digital ink, capabilities in Windows	150
about	15	Display	
caring for	134	problems, general	117
customizing	85	troubleshooting	117
display stand	20	Display stand	20
installation	10	adjusting height	25
overview	15	adjusting incline	25
products matrix	15	cable removal from	28
setting up	10	features	21
testing	112	location	22
the multi-touch experience	70	mounting Cintiq on	141
troubleshooting	111	removing Cintiq from	138
uninstalling	145	Display Toggle, working with	105
working with	31	Double-click, adjusting	91
Cleaning		Dragging, with pen	37
display stand	134	Eraser feel, customizing	92
pen	134	Eraser pressure setting, advanced	92
pen display	134	Ergonomics	32





Expert settings, importing	149	disabling	83
ExpressKeys	39	navigating with	71
testing	115	options	71
using	42	problems, troubleshooting	126
Factory presets	46	setting navigation features	80
FAQs (Frequently Asked Questions)	132	speed, adjusting	80
Features		standard touch functions	81
Cintiq 24HD	18	testing touch	84
Cintiq 24HD touch	16	the experience	70
display stand	21	Navigation, customizing for multi-touch	80
pen	19	New tool, adding	109
pen display	15	On Screen Display (OSD)	47
Front view		controls, Cintiq 24HD	67
Cintiq 24HD	18	controls, Cintiq 24HD touch	48
Cintiq 24HD touch	16	Ordering, parts and accessories	152
Functions, button	97	OSD controls	
General problems, troubleshooting	121	advanced OSD	57
Handedness, configuring for	33	auto adjust (analog input only)	49
Hardware control buttons		brightness/contrast	48
testing	115	color control systems	51
using	41	ECO information	54
Hardware installation, for pen display	11	image controls	49
Height, adjusting	25	information	55
Incline, adjusting	25	menu tools	53
Information, product	151	OSD warning	55
Input tools, testing	114	picture mode function	55
Installation	10	tools	52
hardware	11	Parts	
software	14	available	152
Keyboard, using with Cintiq	27	ordering	152
Mac-specific problems, troubleshooting	128	Pen	
Maintenance and care	134	clicking with	36
Manual, about	5	customizing	90
Monitors, using Cintiq with others	45	dragging with	37
Mount, using alternate	144	erasing, with	38
Multiple tablets, installing	147	features	19
Multiple tools, working with	109	holding	35
Multi-touch		nib, replacing	135
adjusting touch speed	80	positioning with	36
custom touch functions	82	pressure sensitivity, working with	37
customizing	79	testing	116





tilt, drawing with	38	Software	
using	34	installation	14
using side switch	37	updates	131
Pen display		Stand, using alternate	144
adjusting	46	System requirements	10
calibrating	89	Tablet, renaming in Tablet list	110
configuring handedness	33	Technical support, options	130
controls	39	Testing	
customizing functions	94	Cintiq	112
features	15	controls	114
features matrix	15	ExpressKeys	115
front view		hardware control buttons	115
Cintiq 24HD	18	input tools	114
Cintiq 24HD touch	16	multi-touch	84
installation	10	pen	116
hardware	11	Touch Rings	115
software	14	Tilt	
rear view	17	drawing with	38
setting up	10	sensitivity, customizing	94
Touch Rings, customizing	96	Tip feel, adjusting	91
Pen nib, replacing	135	Tip pressure setting, advanced	92
Pen problems, troubleshooting	123	Tool buttons, customizing	93
Pen tablet, troubleshooting	121	Touch	
Pens, optional	90	basic actions	71
Positioning, with pen	36	multi-touch gestures	71
Power saving, functions	69	Touch Rings	39
Preferences, managing	146	customizing	96
Pressure sensitivity, working with	37	testing	115
Product information	151	using	44
Radial Menu		Troubleshooting	111
customizing	104	display portion	117
using	104	general problems	121
Rear view, interactive pen display	17	Mac-specific problems	128
Requirements, system	10	multi-touch problems	126
Setting up	10	pen problems	123
Settings		pen tablet portion	121
changing for specific application and tool	108	testing controls	114
On Screen Display (OSD)	47	testing input tools	114
OSD controls, Cintiq 24HD	67	Windows-specific problems	127
OSD controls, Cintiq 24HD touch	48	Uninstalling	145
removing	108	Unpacking	6
user	46	box contents	8
Side switch, using	37	User settings	46





Using	
ExpressKeys	42
hardware control buttons	41
multi-touch	70
pen	34
Radial Menu	104
Touch Rings	44
VGA problems	120
Windows-specific problems, troubleshooting	127
Work area, setting up	32
Working, with Cintiq	31





WACOM INTERNATIONAL OFFICES

WACOM TECHNOLOGY CORPORATION

1311 SE Cardinal Court
Vancouver, WA 98683
U.S.A.

Telephone: +1.360.896.9833
Fax: +1.360.896.9724

WACOM CO., LTD.

JAPAN TABLET SALES DIVISION

Harmony Tower 18F, 1-32-2 Hon-Cho,
Nakano-Ku, Tokyo 164-0012
Japan

Internet: <http://wacom.jp>

WACOM CHINA CORPORATION

1103, Beijing IFC West Tower
No. 8 Jianguomenwai Street
Chaoyang District, Beijing, 100022
China

Internet: <http://www.wacom.com.cn>

WACOM AUSTRALIA PTY. LTD.

Unit 8, Stage 1 Cumberland Green
2-8 South Street Rydalmere
NSW 2116 Australia

Telephone: +61.2.9422.6700
Fax: +61.2.9420.2272

WACOM TAIWAN INFORMATION CO., LTD.

9F.-1, No.237, Songjiang Rd.,
Zhongshan Dist., Taipei City 104,
Taiwan (R.O.C.)

Internet: www.wacom.asia/tw

WACOM INDIA PVT. LTD.

2nd Floor, Elegance Tower
District Centre, Mathura Road
New Delhi 110025, India

Telephone: +91.11.40601200
Fax: +91.11.40601235

WACOM EUROPE GMBH

Europark Fichtenhain A9
47807 Krefeld
Germany

Internet: <http://www.wacom.eu>

WACOM CO., LTD.

ASIA PACIFIC DIVISION

Harmony Tower 18F, 1-32-2 Hon Cho,
Nakano-Ku, Tokyo 164-0012
Japan

Telephone: +81.3.5309.1513
Fax: +81.3.5309.1514

WACOM KOREA CO., LTD.

#1211, 12F, KGIT Sangam Center,
1601 Sangam-dong, Mapo-gu, Seoul 121-913, Korea

Telephone: +82.2.557.3894
Fax: +82.2.557.3895

WACOM SINGAPORE PTE. LTD.

5 Temasek Boulevard
#12-09 Suntec Tower Five
Singapore 038985

Telephone: +65.6258.8640
Fax: +65.6258.8697

WACOM HONG KONG LIMITED

Room 1201, Tai Tung Building
8 Fleming Road
Wanchai, Hong Kong

Telephone: +852.25739322
Fax: +852.25739500

