



HP Z24i, Z27i, and Z30i IPS Displays

User Guide

© 2013 Hewlett-Packard Development
Company, L.P.

Microsoft® and Windows® are U.S.
registered trademarks of Microsoft
Corporation.

The only warranties for HP products and
services are set forth in the express
warranty statements accompanying such
products and services. Nothing herein
should be construed as constituting an
additional warranty. HP shall not be liable
for technical or editorial errors or omissions
contained herein.

This document contains proprietary
information that is protected by copyright.
No part of this document may be
photocopied, reproduced, or translated to
another language without the prior written
consent of Hewlett-Packard Company.

First Edition (August 2013)

Document Part Number: 727282-001

About This Guide

This guide provides information on monitor features, setting up the monitor, and technical specifications.

 **WARNING!** Text set off in this manner indicates that failure to follow directions could result in bodily harm or loss of life.

 **CAUTION:** Text set off in this manner indicates that failure to follow directions could result in damage to equipment or loss of information.

 **NOTE:** Text set off in this manner provides important supplemental information.

Table of contents

1 Product Features	1
HP IPS Monitors	1
2 Setting Up and Using the Monitor	3
Installing the Stand	3
Rear Components	4
Z24i Model	4
Z27i and Z30i Models	5
Connecting the Cables	6
Front Panel Controls	10
Adjusting the Monitor	11
Turning on the Monitor	14
HP Watermark and Image Retention Policy	14
Connecting USB Devices	15
Removing the Monitor Stand	15
Mounting the Monitor	16
Mounting the Monitor Using the Quick Release 2 Mounting Bracket	17
Mounting the Monitor Without Using the Quick Release 2 Mounting Bracket	20
Locating the Serial Number and Product Number	21
Locating the Information Card	21
Installing a Cable Lock	22
Power Saving Features	22
Power-Saver Mode	22
Auto-Sleep Mode	23
Sleep Timer	23
3 Finding More Information	25
Reference Guides	25
Product Support	25
Appendix A Technical Specifications	26
Z24i Model	26
Z27i Model	26
Z30i Model	28
Recognizing Preset Display Resolutions	29
Z24i Model	29

Z27i Model	30
Z30i Model	31
Entering User Modes	32

1 Product Features

HP IPS Monitors

The LCD (liquid crystal display) monitors have an active matrix, In-Plane Switching (IPS) panel. The monitor models and features include:

- Z24i model, 60.96 cm (24-inch) diagonal viewable area display with 1920 x 1200 resolution, plus full-screen support for lower resolutions: includes custom scaling for maximum image size while preserving original aspect ratio
- Z27i model, 68.58 cm (27-inch) diagonal viewable area display with 2560 x 1440 resolution, plus full-screen support for lower resolutions; includes custom scaling for maximum image size while preserving original aspect ratio
- Z30i model, 76.2 cm (30-inch) diagonal viewable area display with 2560 x 1600 resolution, plus full-screen support for lower resolutions; includes custom scaling for maximum image size while preserving original aspect ratio
- Non-glare panel with an LED backlight
- Wide viewing angle to allow viewing from a sitting or standing position, or moving from side-to-side
- Tilt capability
- Pivot capability to rotate the display from landscape to portrait
- Swivel and height adjustment capabilities
- Removable stand for flexible monitor panel mounting solutions
- HP Quick Release 2 to quickly install the monitor with a simple click and remove it with the convenient sliding tab release
- Optional thin client mounting bracket that attaches to the rear of the stand (purchased separately)
- Easy access pull-out information card with the information needed when contacting HP support
- Video signal input to support VGA analog (cables are provided with select models)
- Video signal input to support DVI digital (cables are provided with select models)
- Video signal input to support DisplayPort digital (cables are provided with select models)
- Video signal input to support HDMI digital (Z27i and Z30i models only)
- Audio output headphone jack (Z27i and Z30i models only)
- USB 2.0 hub (Z24i models) or USB 3.0 hub (Z27i and Z30i models) with one upstream port (connects to the computer) and four downstream ports (connects to USB devices)
- USB cable provided to connect the monitor's USB hub to the USB connector on the computer
- Supports an optional HP speaker bar
- Plug and play capability if supported by your operating system

- Privacy filter slots to insert filters (purchased separately) to block side screen viewing (Z24i model only)
- Security slot provision on rear of monitor for optional cable lock
- Cable management feature for placement of cables and cords
- On-Screen Display (OSD) adjustments in several languages for easy setup and screen optimization
- HP Display Assistant for adjusting monitor settings and enabling theft deterrence features
- HDCP (High-Bandwidth Digital Content Protection) copy protection on all digital inputs
- Software and documentation CD that includes monitor drivers and product documentation
- Energy saver feature to meet requirements for reduced power consumption
- Safety guidelines, certifications, and regulatory notices for these products are available in the *HP LCD Monitors Reference Guide* on the CD included with this monitor.

2 Setting Up and Using the Monitor

To set up the monitor, ensure that the power is turned off to the monitor, computer system, and other attached devices, then follow the instructions below.

 **NOTE:** Be sure the master power switch, located on the rear panel of the monitor, is in the off position. The master power switch turns off all power to the monitor.

Installing the Stand

 **CAUTION:** Do not touch the surface of the LCD panel. Pressure on the panel may cause non-uniformity of color or disorientation of the liquid crystals. If this occurs the screen will not recover to its normal condition.

The displays use the HP Quick Release 2 for easy moving of the monitor. To mount the panel onto the stand:

1. Lay the monitor panel face down on a flat surface covered by a clean, dry cloth.
2. Slide the top of the mounting plate (1) on the stand under the upper lip of the recess in the back of the panel.
3. Lower the bottom of the stand's mounting plate (2) into the recess until it snaps into place.
4. The HP Quick Release 2 latch (3) pops up when the stand is locked in place.



Rear Components

Z24i Model



Component	Function
1 USB 2.0 Downstream Connectors (side panel)	Connects optional USB devices to the monitor.
2 Master Power Switch	Turns off all power to the monitor. NOTE: Putting the switch in the Off position will yield the lowest power state for the monitor when not in use.
3 AC Power Connector	Connects the AC power cord to the monitor.
4 DisplayPort	Connects the DisplayPort cable to the monitor.
5 DVI-D	Connects the DVI-D cable to the monitor.
6 VGA	Connects the VGA cable to the monitor.
7 USB 2.0 Upstream Connector	Connects the USB hub cable to the monitor's USB hub connector and to a host USB port/hub.
8 USB 2.0 Downstream Connectors	Connects optional USB devices to the monitor.

Z27i and Z30i Models



Component	Function
1 USB 3.0 Downstream Connectors (side panel)	Connects optional USB devices to the monitor.
2 Master Power Switch	Turns off all power to the monitor. NOTE: Putting the switch in the Off position will yield the lowest power state for the monitor when not in use.
3 AC Power Connector	Connects the AC power cord to the monitor.
4 DisplayPort	Connects the DisplayPort cable to the monitor.
5 VGA	Connects the VGA cable to the monitor.
6 DVI-D	Connects the DVI-D cable to the monitor.
7 HDMI	Connects an HDMI cable to the monitor.
8 Audio Out	Connects headphones or optional HP Speaker Bar to the monitor.
9 USB 3.0 Upstream Connector	Connects the USB hub cable to the monitor's USB hub connector and to a host USB port/hub.
10 USB 3.0 Downstream Connectors	Connects optional USB devices to the monitor.

Connecting the Cables

1. Place the monitor in a convenient, well-ventilated location near the computer.
2. Before connecting the cables, route the cables through the cable routing hole in the center of the stand.

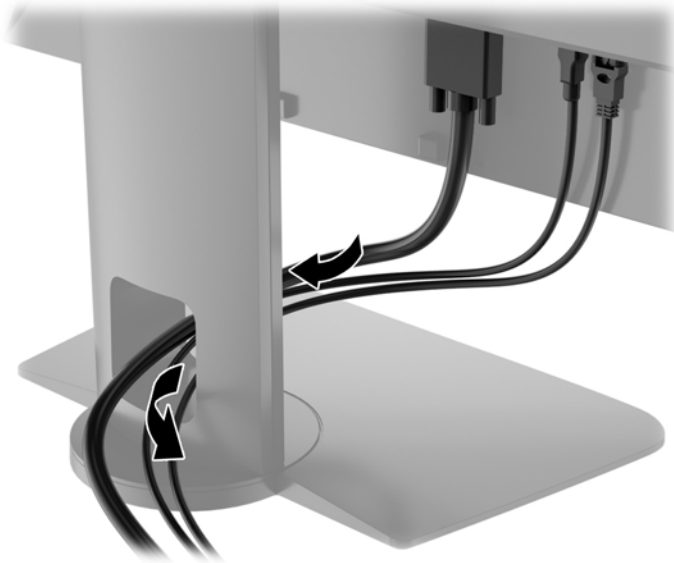

3. Depending on your model and configuration, connect either the DisplayPort, DVI, HDMI, or VGA video cable between the PC and the monitor.

 **NOTE:** The monitor is capable of supporting either analog or digital input. The video mode is determined by the video cable used. The monitor will automatically determine which inputs have valid video signals. The inputs can be selected by pressing the **Input** button on the front panel or through the On-Screen Display (OSD) feature by pressing the **Menu** button.

- For analog operation, connect the VGA signal cable to the VGA connector on the rear of the monitor and the other end to the VGA connector on the computer (cable provided with select models).

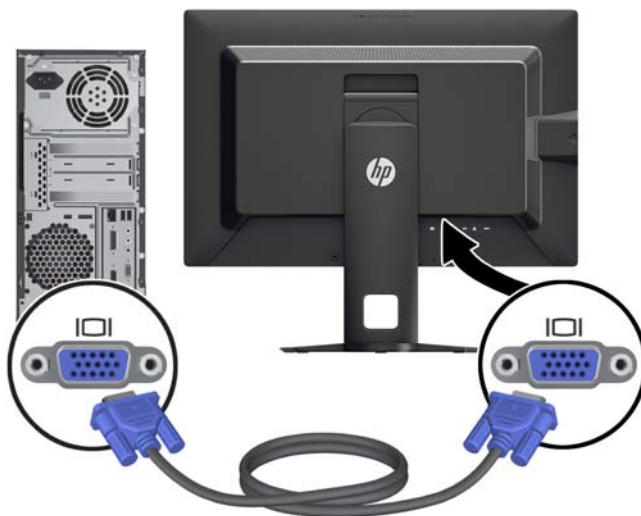

- For DVI digital operation, connect the DVI-D signal cable to the DVI connector on the rear of the monitor and the other end to the DVI connector on the computer (cable provided with select models).

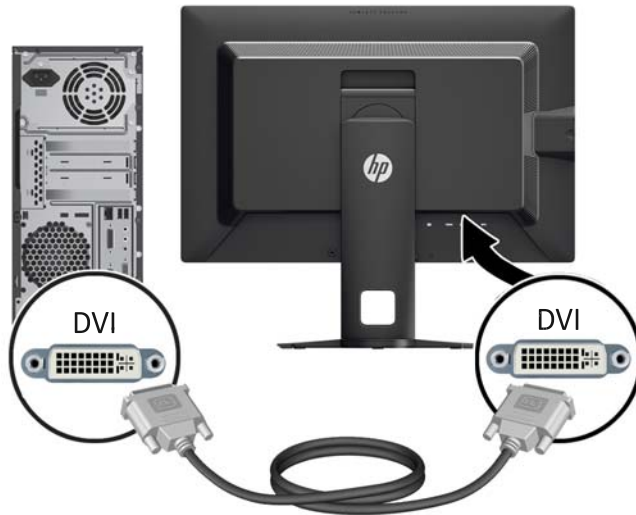

- For DisplayPort digital operation, connect the DisplayPort signal cable to the DisplayPort connector on the rear of the monitor and the other end to the DisplayPort connector on the computer (cable provided with select models).

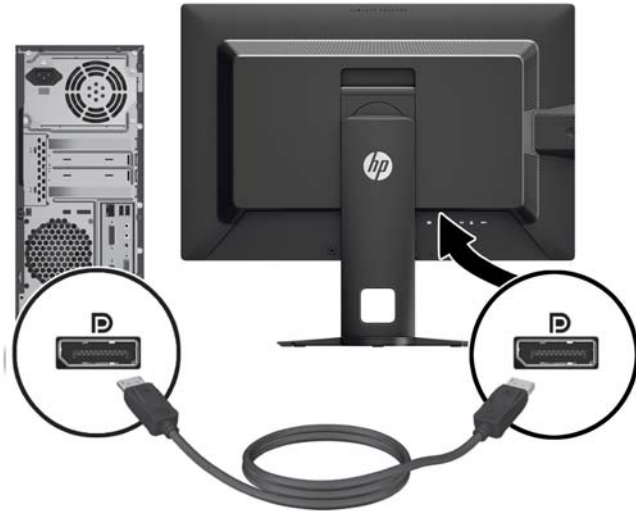

- For HDMI digital operation (Z27i and Z30i models only), connect the HDMI signal cable to the HDMI connector on the rear of the monitor and the other end to the HDMI connector on the computer (cable provided with select models).

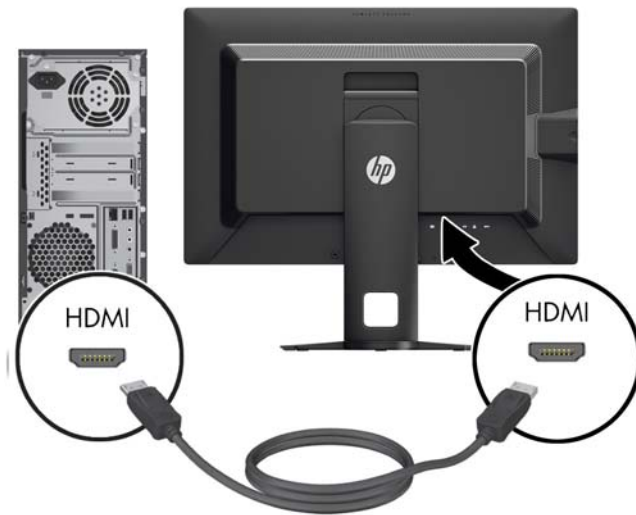

4. Connect one end of the provided USB cable to the USB hub connector on the rear panel of the computer, and the other end to the upstream USB connector on the monitor.

 **NOTE:** The Z24i model supports USB 2.0. The Z27i and Z30i models support USB 3.0.

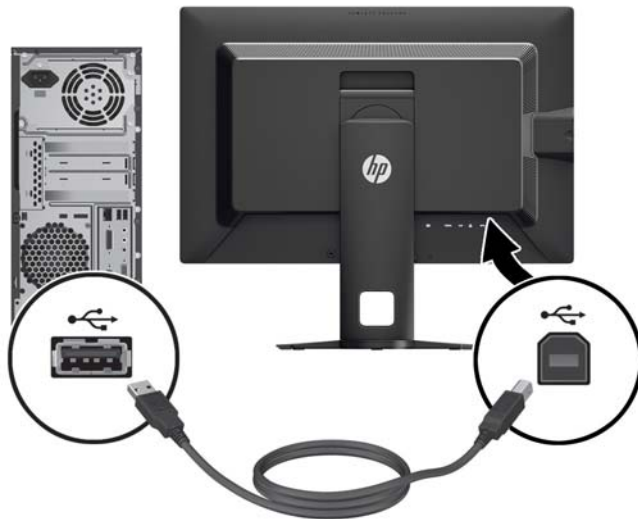

5. Connect one end of the power cord to the AC power connector on the back of the monitor, and the other end to an electrical wall outlet.



⚠ WARNING! To reduce the risk of electric shock or damage to the equipment:

Do not disable the power cord grounding plug. The grounding plug is an important safety feature.





Plug the power cord into a grounded (earthed) electrical outlet that is easily accessible at all times.

Disconnect power from the equipment by unplugging the power cord from the electrical outlet.

For your safety, do not place anything on power cords or cables. Arrange them so that no one may accidentally step on or trip over them. Do not pull on a cord or cable. When unplugging from the electrical outlet, grasp the cord by the plug.

Front Panel Controls



Control	Function
1 	Menu Opens, selects or exits the OSD menu.
2 	Minus If the OSD menu is on, press to navigate backward through the OSD menu and decrease adjustment levels.
3 	Plus/Input If the OSD menu is on, press to navigate forward through the OSD menu and increase adjustment levels. If the OSD menu is inactive, press to activate the input button that chooses the video signal input
4 	OK/Auto Adjust If the OSD menu is on, press to select the highlighted menu item. If the OSD menu is inactive, press to activate the auto adjustment feature to optimize the screen image.
5 	Power Turns the monitor on or off. NOTE: Be sure the master power switch on the rear of the monitor is in the ON position to turn on the monitor.

 **NOTE:** To view an OSD menu simulator, visit the HP Customer Self Repair Services Media Library at <http://www.hp.com/go/sml>.

Adjusting the Monitor

1. Tilt the monitor's panel forward or backward to set it to a comfortable eye level.



2. Swivel the monitor to the left or right for the best viewing angle.



3. Adjust the monitor's height to a comfortable position for your individual workstation. The monitor's top bezel edge should not exceed a height that is parallel to your eye height. A monitor that is positioned low and reclined may be more comfortable for users with corrective lenses. The monitor should be repositioned as you adjust your working posture throughout the work day.

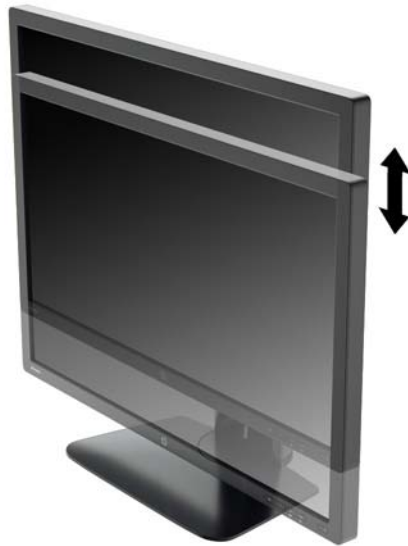

4. You can pivot the monitor from landscape to portrait orientation viewing to adapt to your application.
 - a. Adjust the monitor to full height position and tilt the monitor back to full tilt position (1).
 - b. Pivot the monitor clockwise 90° from landscape to portrait orientation (2).

⚠ CAUTION: If the monitor is not in full height and full tilt position when pivoting, the bottom right corner of the monitor panel will come in contact with the base and potentially cause damage to the monitor.

If you are adding an optional speaker bar to the monitor, install it after pivoting the monitor. The speaker bar will come in contact with the base when pivoting and potentially cause damage to the monitor or speaker bar.



 **NOTE:** To view information on the screen in portrait mode, you can install the HP Display Assistant software included on the software and documentation CD. The position of the OSD menu can also be rotated to portrait mode. To rotate the OSD menu, access the OSD menu by pressing the **Menu** button on the front panel, select **OSD Control** from the menu, then select **Rotate OSD**.

Turning on the Monitor

1. Set the master power switch on the rear of the monitor to the On position.
2. Press the power button on the computer to turn it on.
3. Press the power button on the front of the monitor to turn it on.



CAUTION: Burn-in image damage may occur on monitors that display the same static image on screen for a prolonged period of time.* To avoid burn-in image damage on the monitor screen, you should always activate a screen saver application or turn off the monitor when it is not in use for a prolonged period of time. Image retention is a condition that may occur on all LCD screens. Monitors with a “burned-in image” are not covered under the HP warranty.

* A prolonged period of time is 12 consecutive hours of a static image.

NOTE: If pressing the power button has no effect, the Power Button Lockout feature may be enabled. To disable this feature, press and hold the monitor power button for 10 seconds.

NOTE: You can disable the power LED in the OSD menu. Press the **Menu** button on the front of the monitor, then select **Management > Bezel Power LED > Off**.

When the monitor is powered on, a Monitor Status message is displayed for five seconds. The message shows which input is the current active signal, the status of the auto-switch source setting (On or Off; factory default is On), the default source signal (factory default is DisplayPort), the current preset display resolution, and the recommended preset display resolution.

The monitor automatically scans the signal inputs for an active input and uses that input for the display. If two or more inputs are active, the monitor will display the default input source. If the default source is not one of the active inputs, then the monitor will display the highest ranking priority input. You can change the default source in the OSD by pressing the front panel **Menu** button and selecting **Input Control > Default Input**.

HP Watermark and Image Retention Policy

The IPS monitor models are designed with IPS (In-Plane Switching) display technology which provides ultra-wide viewing angles and advanced image quality. IPS monitors are suitable for a wide variety of advanced image quality applications. This panel technology, however, is not suitable for

applications that exhibit static, stationary or fixed images for long periods of time without the use of screen savers. These types of applications may include camera surveillance, video games, marketing logos, and templates that are displayed on the screen for a prolonged period of time. Static images may cause image retention damage that could look like stains or watermarks on the monitor's screen.

Monitors in use for 24 hours per day that result in image retention damage are not covered under the HP warranty. To avoid image retention damage, always turn off the monitor when it is not in use or use the power management setting, if supported on your system, to turn off the display when the system is idle.

Connecting USB Devices

USB connectors are used to connect devices such as a digital camera, USB keyboard, or USB mouse. There are four downstream USB ports on the monitor (two on the rear and two on the side).

 **NOTE:** You must connect the USB hub cable from the monitor to the computer to enable the USB ports on the monitor. Refer to Step 4 in [Connecting the Cables on page 6](#).



Removing the Monitor Stand

You can remove the monitor panel from the stand to install the panel on a wall, a swing arm, or other mounting fixture.

 **CAUTION:** Before beginning to disassemble the monitor, be sure the monitor is turned off and the power and signal cables are both disconnected. Also disconnect all USB cables connected to the monitor.

1. Disconnect and remove the signal, power, and USB cables from the monitor.
2. Lay the monitor face down on a flat surface covered by a clean, dry cloth.
3. Press down on the latch near the bottom center of the monitor to unlock the HP Quick Release 2 (1).
4. Swing the bottom of the stand up until the mounting plate clears the recess in the panel (2).

5. Slide the stand out of the recess (3).



Mounting the Monitor

The monitor panel can be attached to a wall, swing arm, or other mounting fixture.

You can attach the monitor panel to a mounting fixture using the HP Quick Release 2 mounting bracket or you can attach the monitor panel to a mounting fixture without the HP Quick Release 2 mounting bracket.

 **NOTE:** This apparatus is intended to be supported by UL or CSA Listed wall mount bracket.

 **CAUTION:** This monitor supports the VESA industry standard 100 mm mounting holes. To attach a third-party mounting solution to the monitor, four 4 mm, 0.7 pitch, and 10 mm long screws are required. Longer screws must not be used because they may damage the monitor. It is important to verify that the manufacturer's mounting solution is compliant with the VESA standard and is rated to support the weight of the monitor display panel. For best performance, it is important to use the power and video cables provided with the monitor.

Mounting the Monitor Using the Quick Release 2 Mounting Bracket

To mount the monitor panel to a mounting fixture using the Quick Release 2 mounting bracket:

1. Remove the four screws holding the mounting plate to the head of the stand.

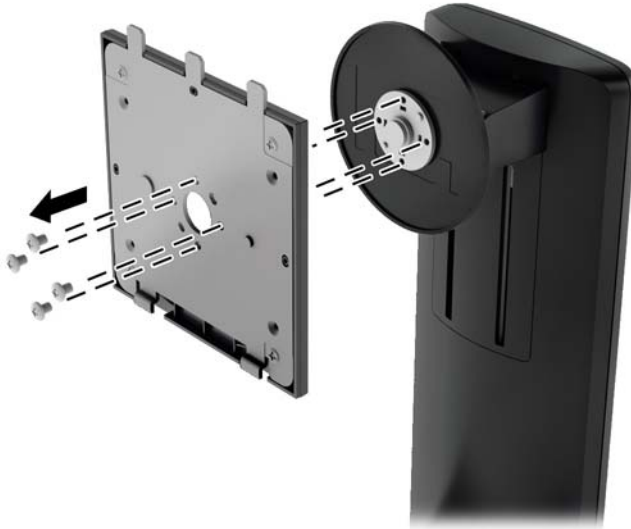

2. Remove the four screws from the mounting plate to separate the mounting plate from its cover.

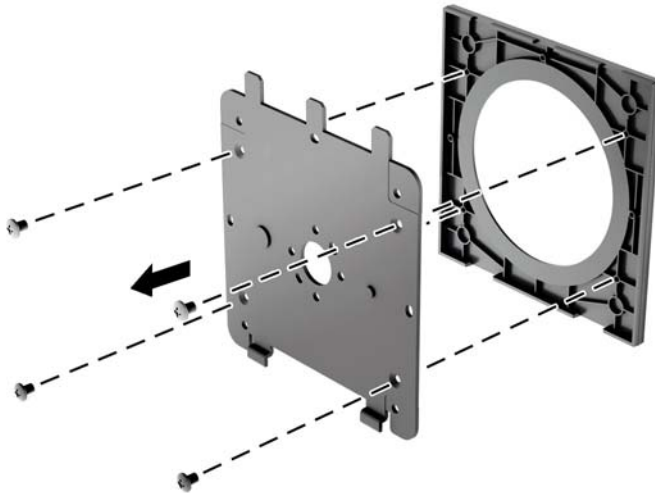

3. Remove the four screws from the VESA holes located on the rear of the monitor panel.



4. Install the mounting plate to the wall or swing arm of your choice using the four screws that were removed from the VESA holes on the rear of the monitor panel.

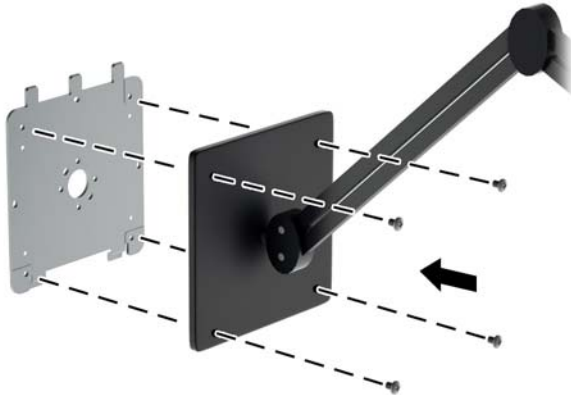

5. Place the monitor panel on the mounting bracket you've installed by aligning its recess with the mounting bracket, then sliding it down over the top of the bracket and pressing it back into place against the bracket. The release latch on the monitor will pop up when the monitor is safely locked in place.



Mounting the Monitor Without Using the Quick Release 2 Mounting Bracket

To mount the monitor panel directly to a mounting fixture without using the HP Quick Release 2 mounting bracket, use the four screws removed from the VESA holes on rear of the monitor panel and install them to attach the mounting device to the rear of the monitor panel.



Locating the Serial Number and Product Number

The serial number and product number are located on a label on the rear panel of the display head. You may need these numbers when contacting HP about the monitor model.

 **NOTE:** You may need to partially pivot the display head to read the label.



Locating the Information Card

Identifying information is located on the pull-out card (and included on a label on the back of the monitor). The card pulls out from behind the USB connectors on the left side of the panel. Warranty support information (model number, serial number, product number) is printed on the front of the card (and the label) and regulatory information is printed on the back of the card.



Installing a Cable Lock

You can secure the monitor to a fixed object with an optional cable lock available from HP.

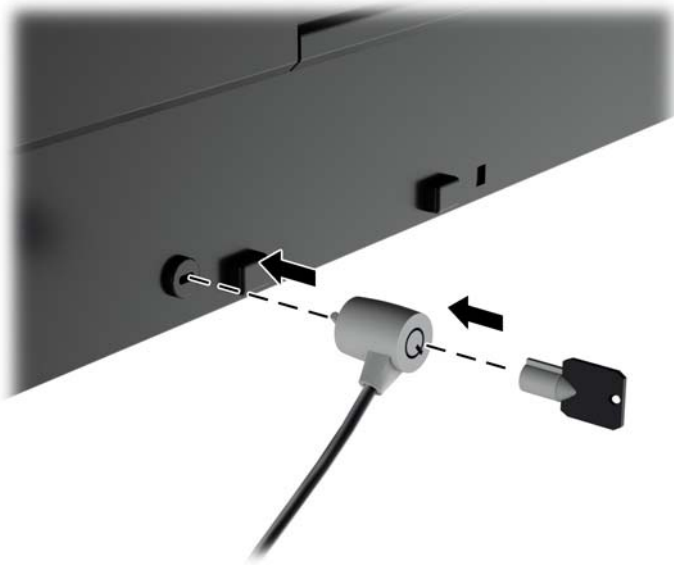

Power Saving Features

The monitors support a reduced power state. The reduced power state will be entered into if the monitor detects the absence of either the horizontal sync signal and/or the vertical sync signal. Upon detecting the absence of these signals, the monitor screen is blanked, the backlight is turned off, and the power light is turned amber. When the monitor is in the reduced power state, the monitor will utilize .5 watts of power. There is a brief warm up period before the monitor will return to its normal operating mode.

Refer to the computer manual for instructions on setting energy saver features (sometimes called power management features).

 **NOTE:** The above power saver feature only works when connected to computers that have energy saver features.

By selecting the settings in the monitor's energy saver utility, you can also program the monitor to enter into the reduced power state at a predetermined time. When the monitor's energy saver utility causes the monitor to enter the reduced power state, the power light blinks amber.

Power-Saver Mode

The monitor includes a Power-Saver Mode that can be quickly adjusted in the OSD while the monitor is still in use. The Power Saver function serves primarily to reduce LED backlight current (display brightness) in stages to enable power savings of the monitor. The savings levels are NOT calibrated but are approximate savings based on power measurements conducted during product qualification.

To adjust the power savings, press the **Menu** button on the front of the monitor to open the OSD and select **Management > Power-Saver Mode**. Set the power savings to one of the following:

- Off
- 10% Savings
- 20% Savings

- 30% Savings
- 40% Savings
- 50% Savings

 **NOTE:** The power saving percentages are based on a pre-test of multiple units. Actual power reductions and screen results may vary from unit to unit.

Adjusting the power saving percentages does not affect power reserved for the USB ports.

Auto-Sleep Mode

These displays support an OSD (On-Screen Display) option called **Auto-Sleep Mode**, that allows you to enable or disable a reduced power state for the display. When Auto-Sleep Mode is enabled (enabled by default), the monitor will enter a reduced power state when the host PC signals low power mode (absence of either horizontal or vertical sync signal).

Upon entering this reduced power state sleep mode, the monitor screen is blanked, the backlight is turned off and the power LED indicator turns amber. The monitor draws less than 0.5W of power when in this reduced power mode. The monitor will wake from the sleep mode when the host PC sends an active signal to the monitor (for example, if the user activates the mouse or keyboard).

Sleep Timer

The Sleep Timer OSD (On-Screen Display) option is an energy-saving feature that enables you to set a time for the monitor to enter and exit a reduced power state (Sleep Mode) at the programmable times each day. This can help you save energy and can potentially extend the life of the display.

The Sleep Timer has five settings:

- Set Current Time
- Set Sleep Time
- Set On Time
- Timer: On/Off
- Sleep Now

To set the timer:

1. Press the **Menu** button on the monitor front panel to display the **OSD Menu**.
2. Scroll down and highlight **Management**.
3. Press the **OK** button to select **Management**.
4. Scroll down and highlight and select **Sleep Timer > Set Current Time**.

 **NOTE:** You must set the current local time before you set the time for **Sleep Time** or **On Time**. Note that the time is displayed in a 24-hour clock format. For example, 1:15 p.m. is displayed as 13 hours 15 minutes.

A power failure or loss of power to the monitor will cause the timer to reset to 00:00. If this occurs, you will need to reset the sleep timer.

5. Press the **OK** button once to enter the adjustment mode for hours.
6. Press the **-** (Minus) or **+** (Plus) button to adjust the hour.
7. Press the **OK** button again to enter the time for minutes.

8. Press the - (Minus) or + (Plus) button to adjust the minutes.
9. Press the **OK** button to lock in the time chosen.
10. After setting the current time, the highlight automatically skips to **Set Sleep Time**. Repeat steps 6 through 9 to set **Sleep Time**.
11. If you do not want to set **Sleep Time**, press the **OK** button twice, then select **Save and Return** to exit the menu.
12. After setting **Sleep Time**, the highlight automatically skips to **Set On Time**. Repeat steps 6 through 9 to set **On Time**.
13. Set the **Timer** to **On** to activate the **Sleep Timer** settings.
14. When you are finished, select **Save and Return** to exit the menu.

The fifth selection, **Sleep Now**, turns the monitor backlights off immediately and stays in sleep mode until the next **On Time** activates or a monitor button is pressed.

3 Finding More Information

Reference Guides

Refer to the *HP LCD Monitors Reference Guide* included on the CD with your monitor for additional information on:

- Optimizing monitor performance
- Safety and maintenance guidelines
- Installing software from the CD
- Using the OSD menu
- Downloading software from the Web
- Agency regulatory information
- Troubleshooting and recommended solutions to common problems

For information on theft deterrence, refer to the *HP Display Assistant User Guide* included on the CD with your monitor.

Product Support

For additional information on using and adjusting your monitor, go to <http://www.hp.com/support>. Select your country or region, select **Product Support & Troubleshooting**, and then enter your monitor model in the SEARCH window.



NOTE: The monitor user guide, reference guide, and drivers are available at <http://www.hp.com/support>.

If the information provided in the guide or in the *HP LCD Monitors Reference Guide* do not address your questions, you can contact support. For U.S. support, go to <http://www.hp.com/go/contactHP>. For worldwide support, go to http://welcome.hp.com/country/us/en/wwcontact_us.html.

Here you can:

- Chat online with an HP technician



NOTE: When support chat is not available in a particular language, it is available in English.

- E-mail support
- Find support telephone numbers
- Locate an HP service center

A Technical Specifications

 **NOTE:** All specifications represent the typical specifications provided by HP's component manufacturers; actual performance may vary either higher or lower.

Z24i Model

Display	60.96 cm wide screen	24 inches wide screen
Type	IPS LCD	
Viewable Image Size	60.96 cm diagonal	24-inch diagonal
Maximum Weight (Unpacked)	6.96 kg	15.34 lbs
Dimensions (include base)		
Height (highest position)	52.5 cm	20.67 inches
Height (lowest position)	40.5 cm	15.94 inches
Depth	23.798 cm	9.37 inches
Width	55.94 cm	22.02 inches
Maximum Graphic Resolution	1920 x 1200 (60 Hz) analog input 1920 x 1200 (60 Hz) digital input	
Optimum Graphic Resolution	1920 x 1200 (60 Hz) analog input 1920 x 1200 (60 Hz) digital input	
Environmental Requirements Temperature		
Operating Temperature	5 to 35° C	41 to 95° F
Storage Temperature	-20 to 60° C	-4 to 140° F
Power Source	100 – 240 VAC 50/60 Hz	
Input Terminal	One VGA connector; one DVI connector; one DisplayPort connector (cable inclusion varies by region)	

NOTE: For the latest specifications or additional specifications on this product, go to <http://www.hp.com/go/productbulletin> and search for your specific display model to find the model-specific QuickSpecs.

Z27i Model

Display	68.58 cm wide screen	27 inches wide screen
Type	IPS LCD	
Viewable Image Size	68.58 cm diagonal	27-inch diagonal
Maximum Weight (Unpacked)	7.6 kg	16.74 lbs

Dimensions (include base)		
Height (highest position)	54.04 cm	21.28 inches
Height (lowest position)	42.04 cm	16.55 inches
Depth	24.248 cm	9.55 inches
Width	64.10 cm	25.24 inches
Maximum Graphic Resolution		
	1920 x 1200 (60 Hz) analog input	
	2560 x 1440 (60 Hz) digital input	
Optimum Graphic Resolution		
	1920 x 1200 (60 Hz) analog input	
	2560 x 1440 (60 Hz) digital input	
Environmental Requirements Temperature		
Operating Temperature	5 to 35° C	41 to 95° F
Storage Temperature	-20 to 60° C	-4 to 140° F
Power Source		
	100 – 240 VAC 50/60 Hz	
Input Terminal		
	One VGA connector; one DVI connector; one HDMI connector; one DisplayPort connector (cable inclusion varies by region)	

NOTE: For the latest specifications or additional specifications on this product, go to <http://www.hp.com/go/productbulletin> and search for your specific display model to find the model-specific QuickSpecs.

Z30i Model

Display	76.2 cm wide screen	30 inches wide screen
Type	IPS LCD	
Viewable Image Size	76.2 cm diagonal	30-inch diagonal
Maximum Weight (Unpacked)	9.96 kg	21.96 lbs
Dimensions (include base)		
Height (highest position)	60.1 cm	23.66 inches
Height (lowest position)	48.1 cm	18.94 inches
Depth	26.648 cm	10.49 inches
Width	69.03 cm	27.18 inches
Maximum Graphic Resolution	1920 x 1200 (60 Hz) analog input 2560 x 1600 (60 Hz) digital input	
Optimum Graphic Resolution	1920 x 1200 (60 Hz) analog input 2560 x 1600 (60 Hz) digital input	
Environmental Requirements Temperature		
Operating Temperature	5 to 35° C	41 to 95° F
Storage Temperature	-20 to 60° C	-4 to 140° F
Power Source	100 – 240 VAC 50/60 Hz	
Input Terminal	One VGA connector; one DVI connector; one HDMI connector; one DisplayPort connector (cable inclusion varies by region)	

NOTE: For the latest specifications or additional specifications on this product, go to <http://www.hp.com/go/productbulletin> and search for your specific display model to find the model-specific QuickSpecs.

Recognizing Preset Display Resolutions

The display resolutions listed below are the most commonly used modes and are set as factory defaults. This monitor automatically recognizes these preset modes and they will appear properly sized and centered on the screen.

Z24i Model

Preset	Pixel Format	Horz Freq (kHz)	Vert Freq (Hz)
1	640 × 480	31.469	59.940
2	720 × 400	31.469	70.087
3	800 × 600	37.879	60.317
4	1024 × 768	48.363	60.004
5	1280 × 1024	63.981	60.02
6	1440 × 900	55.935	59.887
7	1680 × 1050	65.29	59.954
8	1920 × 1080	67.5	60.00
9	1920 × 1200	74.038	59.950
10	1920 × 1200	74.556	59.885

Preset	Timing Name	Pixel Format	Horz Freq (kHz)	Vert Freq (Hz)
1	480p	720 × 480	31.469	59.94
2	576p	720 × 576	31.25	50
3	720p50	1280 × 720	37.5	50
4	720p60	1280 × 720	45	60
5	1080p50	1920 × 1080	56.25	50
6	1080p60	1920 × 1080	67.5	60

Z27i Model

Preset	Pixel Format	Horz Freq (kHz)	Vert Freq (Hz)
1	640 × 480	31.469	59.940
2	720 × 400	31.469	70.087
3	800 × 600	37.879	60.317
4	1024 × 768	48.363	60.004
5	1280 × 720	45.00	59.94
6	1280 × 800	49.702	59.81
7	1280 × 1024	63.981	60.02
8	1366 × 768	47.712	59.79
9	1440 × 900	55.935	59.887
10	1600 × 900	55.935	59.887
11	1680 × 1050	65.29	59.954
12	1920 × 1080	67.5	60.00
13	1920 × 1200	74.038	59.950
14	1600 × 1200	75.00	60.000
15	1920 × 1200	74.556	59.885
16	2560 × 1440	88.787	59.951

Preset	Timing Name	Pixel Format	Horz Freq (kHz)	Vert Freq (Hz)
1	480p	720 × 480	31.469	59.94
2	576p	720 × 576	31.25	50
3	720p50	1280 × 720	37.5	50
4	720p60	1280 × 720	45	60
5	1080p50	1920 × 1080	56.25	50
6	1080p60	1920 × 1080	67.5	60

Z30i Model

Preset	Pixel Format	Horz Freq (kHz)	Vert Freq (Hz)
1	640 × 480	31.469	59.940
2	720 × 400	31.469	70.087
3	800 × 600	37.879	60.317
4	1024 × 768	48.363	60.004
5	1280 × 720	45.00	59.94
6	1280 × 800	49.702	59.81
7	1280 × 1024	63.981	60.02
8	1366 × 768	47.712	59.79
9	1440 × 900	55.935	59.887
10	1600 × 900	55.935	59.887
11	1680 × 1050	65.29	59.954
12	1920 × 1080	67.5	60.00
13	1920 × 1200	74.038	59.950
14	1600 × 1200	75.00	60.000
15	1920 × 1200	74.556	59.885
16	2560 × 1440	88.787	59.951
17	2560 × 1600	98.713	59.972

Preset	Timing Name	Pixel Format	Horz Freq (kHz)	Vert Freq (Hz)
1	480p	720 × 480	31.469	59.94
2	576p	720 × 576	31.25	50
3	720p50	1280 × 720	37.5	50
4	720p60	1280 × 720	45	60
5	1080p50	1920 × 1080	56.25	50
6	1080p60	1920 × 1080	67.5	60

Entering User Modes

The video controller signal may occasionally call for a mode that is not preset if:

- You are not using a standard graphics adapter.
- You are not using a preset mode.

If this occurs, you may need to readjust the parameters of the monitor screen by using the on-screen display. Your changes can be made to any or all of these modes and saved in memory. The monitor automatically stores the new setting, then recognizes the new mode just as it does a preset mode. In addition to the factory preset modes, there are at least 10 user modes that can be entered and stored.