

# Acer Projector

P7213/F213/PF-X14/P7215/  
F217/PF-X16 Series  
User's Guide

Copyright © 2012. Acer Incorporated.  
All Rights Reserved.

Acer Projector P7213/F213/PF-X14/P7215/F217/PF-X16 Series User's Guide  
Original Issue: 04/2012

Changes may be made periodically to the information in this publication without obligation to notify any person of such revisions or changes. Such changes will be incorporated in new editions of this manual or supplementary documents and publications. This company makes no representations or warranties, either expressed or implied, with respect to the contents hereof and specifically disclaims the implied warranties of merchantability or fitness for a particular purpose.

Record the model number, serial number, purchase date and place of purchase information in the space provided below. The serial number and model number are recorded on the label affixed to your projector. All correspondence concerning your unit should include the serial number, model number and purchase information.

No part of this publication may be reproduced, stored in a retrieval system, or transmitted, in any form or by any means, electronically, mechanically, by photocopy, recording or otherwise, without the prior written permission of Acer Incorporated.

Acer Projector P7213/F213/PF-X14/P7215/F217/PF-X16 Series

Model number: \_\_\_\_\_

Serial number: \_\_\_\_\_

Date of purchase: \_\_\_\_\_

Place of purchase: \_\_\_\_\_

Acer and the Acer logo are registered trademarks of Acer Incorporated. Other companies' product names or trademarks are used herein for identification purposes only and belong to their respective companies.

"HDMI™, the HDMI logo and High-Definition Multimedia Interface are trademarks or registered trademarks of HDMI Licensing LLC."

# Information for your safety and comfort

Read these instructions carefully. Keep this document for future reference. Follow all warnings and instructions marked on the product.

## Turning the product off before cleaning

Unplug this product from the wall outlet before cleaning. Do not use liquid cleaners or aerosol cleaners. Use a damp cloth for cleaning.

## Caution for plug as disconnecting device

Observe the following guidelines when connecting and disconnecting power to the external power supply unit:

- Install the power supply unit before connecting the power cord to the AC power outlet.
- Unplug the power cord before removing the power supply unit from the projector.
- If the system has multiple sources of power, disconnect power from the system by unplugging all power cords from the power supplies.

## Caution for Accessibility

Be sure that the power outlet you plug the power cord into is easily accessible and located as close to the equipment operator as possible. When you need to disconnect power to the equipment, be sure to unplug the power cord from the electrical outlet.



### Warnings!

- Do not use this product near water.
- Do not place this product on an unstable cart, stand or table. If the product falls, it could be seriously damaged.
- Slots and openings are provided for ventilation to ensure reliable operation of the product and to protect it from overheating. These openings must not be blocked or covered. The openings should never be blocked by placing the product on a bed, sofa, rug or other similar surface.

This product should never be placed near or over a radiator or heat register, or in a built-in installation unless proper ventilation is provided.

- Never push objects of any kind into this product through cabinet slots as they may touch dangerous voltage points or short-out parts that could result in a fire or electric shock. Never spill liquid of any kind onto or into the product.

- To avoid damage of internal components and to prevent battery leakage, do not place the product on a vibrating surface.
- Never use it under sporting, exercising, or any vibrating environment which will probably cause unexpected short current or damage rotor devices, lamp.

## Using electrical power

- This product should be operated from the type of power indicated on the marking label. If you are not sure of the type of power available, consult your dealer or local power company.
- Do not allow anything to rest on the power cord. Do not locate this product where people will walk on the cord.
- If an extension cord is used with this product, make sure that the total ampere rating of the equipment plugged into the extension cord does not exceed the extension cord ampere rating. Also, make sure that the total rating of all products plugged into the wall outlet does not exceed the fuse rating.
- Do not overload a power outlet, strip or receptacle by plugging in too many devices. The overall system load must not exceed 80% of the branch circuit rating. If power strips are used, the load should not exceed 80% of the power strip's input rating.
- This product's AC adapter is equipped with a three-wire grounded plug. The plug only fits in a grounded power outlet. Make sure the power outlet is properly grounded before inserting the AC adapter plug. Do not insert the plug into a non-grounded power outlet. Contact your electrician for details.



.....  
**Warning! The grounding pin is a safety feature. Using a power outlet that is not properly grounded may result in electric shock and/or injury.**



.....  
**Note: The grounding pin also provides good protection from unexpected noise produced by other nearby electrical devices that may interfere with the performance of this product.**

- Use the product only with the supplied power supply cord set. If you need to replace the power cord set, make sure that the new power cord meets the following requirements: detachable type, UL listed/CSA certified, VDE approved or its equivalent, 4.5 meters (15 feet) maximum length.

## Product servicing

Do not attempt to service this product yourself, as opening or removing covers may expose you to dangerous voltage points or other risks. Refer all servicing to qualified service personnel.

Unplug this product from the wall outlet and refer servicing to qualified service personnel when:

- the power cord or plug is damaged, cut or frayed
- liquid was spilled into the product
- the product was exposed to rain or water
- the product has been dropped or the case has been damaged
- the product exhibits a distinct change in performance, indicating a need for service
- the product does not operate normally after following the operating instructions



.....

**Note:** Adjust only those controls that are covered by the operating instructions, since improper adjustment of other controls may result in damage and will often require extensive work by a qualified technician to restore the product to normal condition.



.....

**Warning!** For safety reasons, do not use non-compliant parts when adding or changing components. Consult your reseller for purchase options.

Your device and its enhancements may contain small parts. Keep them out of the reach of small children.

## Additional safety information

- Do not look into the projector's lens when the lamp is on. The bright may hurt your eyes.
- Turn on the projector first and then signal sources.
- Do not place the product in following environments:
  - Space that is poorly ventilated or confined. At least 50cm clearance from walls and free flow of air around the projector is necessary.
  - Locations where temperatures may become excessively high, such as inside of a car with all windows rolled up.
  - Locations where excessive humidity, dust, or cigarette smoke may contaminate optical components, shortening the life span and darkening the image.
  - Locations near fire alarms.
  - Locations with an ambient temperature above 40 °C/104 °F.
  - Locations where the altitudes are higher than 10,000 feet.
- Unplug immediately if there is something wrong with your projector. Do not operate if smoke, strange noise or odor comes out of your projector. It

might cause fire or electric shock.

- Do not use the product if it has been dropped or the case is broken. Return it to a dealer for inspection.
- Do not face the projector lens to the sun. It can lead to fire.
- Do not disconnect the power while the projector is operation. Wait until the fan has stopped running before turning the main power off.
- The ventilation area and bottom plate will become hot during use. Do not touch them.
- If a dust filter is fitted, clean it regularly to ensure adequate cooling. Clogged filters may lead to high temperatures that will damage the device.
- Do not look into the ventilation slots while the lamp is on. The bright light may hurt your eyes.
- Always open the lens shutter or remove the lens cap when the projector is on.
- Do not place items in front of the projector when it is turned on, as the heat from the lamp may damage items or cause a fire. If you wish to turn off the lamp temporarily, press **HIDE** on the remote control.
- The lamp becomes extremely hot during operation. Allow the projector to cool for approximately 45 minutes prior to removing the lamp assembly for replacement.
- Do not operate the lamp for longer than its indicated lifespan. Doing so may lead to the lamp failing.
- Never replace the lamp assembly or any electronic components unless the projector is unplugged.
- The projector will warn you when the lamp life is over. Replace the lamp as soon as possible after the warning is displayed.
- When changing the lamp, allow the unit to cool down, and follow the instructions included with the replacement lamp.
- Reset the lamp timer from **Management > Lamp Hour Reset** in the OSD after replacing the lamp module.
- Do not attempt to disassemble the projector. There are high-voltage components inside which may cause injury. Refer all servicing to qualified service personnel.
- Do not stand the projector on its sides. It may fall over causing injury and damaging the projector.
- This projector may be mounted from the ceiling. Use only an Acer mounting kit and ensure it is securely installed.

## Caution when listening to audio

To protect your hearing, follow these instructions.

- Increase the volume gradually until you can hear clearly and comfortably.
- Do not increase the volume level after your ears have adjusted.
- Do not listen to music at high volumes for extended periods.
- Do not increase the volume to block out noisy surroundings.
- Decrease the volume if you can't hear people speaking near you.

## Disposal instructions

Do not throw this electronic device into the trash when discarding. To minimize pollution and ensure utmost protection of the global environment, please recycle. For more information on the Waste from Electrical and Electronics Equipment (WEEE) regulations, visit <http://www.acer-group.com/public/Sustainability/sustainability01.htm>



## Mercury advisory

For projectors or electronic products containing an LCD/CRT monitor or display:

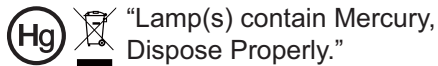

Lamp(s) inside this product contain mercury and must be recycled or disposed of according to local, state or federal laws. For more information, contact the Electronic Industries Alliance at [www.eiae.org](http://www.eiae.org). For lamp-specific disposal information, check [www.lamprecycle.org](http://www.lamprecycle.org)

# First things first

## Usage Notes

Do:

- Turn off the product before cleaning.
- Use a soft cloth moistened with mild detergent to clean the display housing.
- Disconnect the power plug from AC outlet if the product is not being used for a long period of time.

Don't:

- Block the slots and openings on the unit provided for ventilation.
- Use abrasive cleaners, waxes or solvents to clean the unit.
- Use under the following conditions:
  - In extremely hot, cold or humid environments.
  - In areas susceptible to excessive dust and dirt.
  - Near any appliance that generates a strong magnetic field.
  - Place In direct sunlight.

## Precautions

Follow all warnings, precautions and maintenance as recommended in this user's guide to maximize the life of your unit.



### Warning:

- Do not look into the projector's lens when the lamp is on. The bright light may hurt your eyes.
- To reduce the risk of fire or electric shock, do not expose this product to rain or moisture.
- Please do not open or disassemble the product as this may cause electric shock.
- When changing the lamp, please allow unit to cool down, and follow all changing instructions.
- This product will detect the life of the lamp itself. Please be sure to change the lamp when it shows warning messages.
- Reset the "Lamp Hour Reset" function from the Onscreen display "Management" menu after replacing the lamp module.
- When switching the projector off, please ensure the projector completes its cooling cycle before disconnecting power.
- Turn on the projector first and then the signal sources.
- Do not use lens cap when projector is in operation.
- When the lamp reaches the end of its life, it will burn out and may make a loud popping sound. If this happens, the projector will not turn back on until the lamp module has been replaced. To replace the lamp, follow the procedures listed under "Replacing the Lamp".



|  |      |
|--|------|
| Information for your safety and comfort                          | iii  |
| First things first   | viii |
| Usage Notes  | viii |
| Precautions  | viii |
| Introduction   | 1    |
| Product Features   | 1    |
| Package Overview   | 2    |
| Projector Overview   | 3    |
| Projector Outlook  | 3    |
| Control Panel  | 5    |
| Remote Control Layout  | 6    |
| Getting Started  | 8    |
| Connecting the Projector   | 8    |
| Turning the Projector On/Off                                     | 9    |
| Turning on the Projector   | 9    |
| Turning the projector off  | 10   |
| Adjusting the Projected Image                                    | 11   |
| Adjusting the Height of Projected Image                          | 11   |
| How to optimize image size and distance                          | 12   |
| How to get a preferred image size by adjusting distance and zoom | 14   |
| User Controls  | 16   |
| Installation menu  | 16   |
| Acer Empowering Technology                                       | 17   |
| Onscreen Display (OSD) Menus                                     | 18   |
| Color  | 19   |
| Image  | 20   |
| Setting  | 22   |
| Management   | 25   |
| Audio  | 25   |
| 3D   | 26   |
| Language   | 27   |
| Appendices   | 28   |

# Contents

|   |    |
|---|----|
| Troubleshooting                         | 28 |
| LED & Alarm Definition Listing          | 32 |
| Cleaning and replacing the dust filters | 33 |
| Replacing the Lamp                      | 34 |
| Ceiling Mount Installation              | 36 |
| Specifications                          | 39 |
| Compatibility modes                     | 41 |
| Regulations and safety notices          | 45 |

# Introduction

## Product Features

This product is a single-chip DLP® projector. Outstanding features include:

- DLP® technology
- True 1024 x 768 XGA resolution  
4:3 / 16:9 aspect ratio supported
- Acer ColorBoost technology delivers nature's true colors for vivid, life-like images
- Acer ColorSafe II technology ensures consistent color rendition over time
- High brightness and contrast ratio
- Versatile display modes (Bright, Presentation, Standard, Video, User) enable optimum performance in any situation
- NTSC / PAL / SECAM compatible and HDTV (720p, 1080i, 1080p) supported
- Top-loading lamp design allows easy lamp replacement
- Lower power consumption and economy (ECO) mode extends lamp life
- Acer EcoProjecton Technology delivers Intelligent power management approach and physical efficiency improvement
- Empowering Key reveals Acer Empowering Technology utilities (Acer eView, eTimer, e3D, ePower Management) for easy adjustment of settings
- Equipped with HDMI™ connection supporting HDCP
- Advanced digital keystone correction optimizes presentations
- Smart detection delivers quick, intelligent source detection
- Multi-language on screen display (OSD) menus
- Full-function remote control
- Manual focus projection lens zooms up to 1.2x
- 2x digital zoom and pan move function
- Microsoft® Windows® 2000, XP, Vista®, Windows® 7, OS compliant



# Projector Overview

## Projector Outlook

Front / upper side

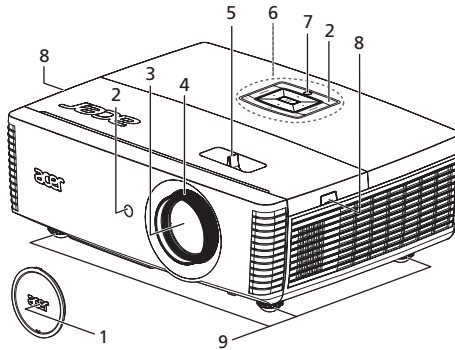

| # | Description              | # | Description           |
|---|--------------------------|---|-----------------------|
| 1 | Lens cap                 | 6 | Control panel         |
| 2 | Remote control receivers | 7 | Power button          |
| 3 | Zoom Lens                | 8 | Screw cover           |
| 4 | Focus ring               | 9 | Tilt adjusting wheels |
| 5 | Zoom lever               |   |                       |

## Rear side

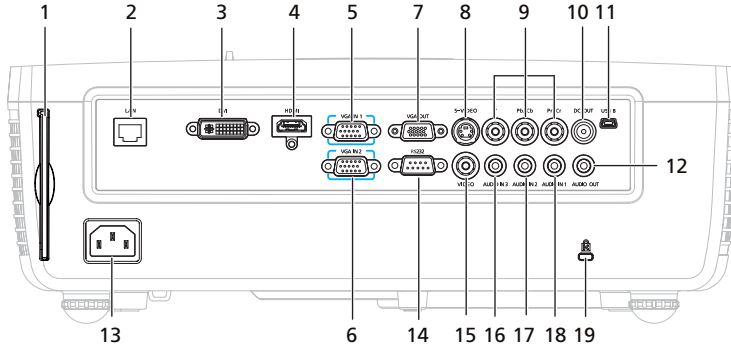

| #  | Description   | #  | Description                                     |
|----|---|----|---|
| 1  | Dust filter   | 11 | Mini USB  |
| 2  | LAN (RJ45 Port for 10/100M Ethernet)                        | 12 | Audio output connector                          |
| 3  | DVI input connector (for digital signal with HDCP function) | 13 | Power socket                                    |
| 4  | HDMI connector  | 14 | RS232 connector                                 |
| 5  | PC analog signal/component video input connector (VGA IN 1) | 15 | Composite video input connector                 |
| 6  | PC analog signal/component video input connector (VGA IN 2) | 16 | Audio input 3 connector (Composite/S-Video)     |
| 7  | Monitor loop-through output connector (VGA-Out)             | 17 | Audio input 2 connector (VGA IN 1/VGA IN 2/DVI) |
| 8  | S-Video input connector                                     | 18 | Audio input 1 connector (Y,Pb,Pr)               |
| 9  | YPbPr/YCbCr input connector                                 | 19 | Kensington™ lock port                           |
| 10 | 12V DC output connector                                     |    |   |

## Control Panel

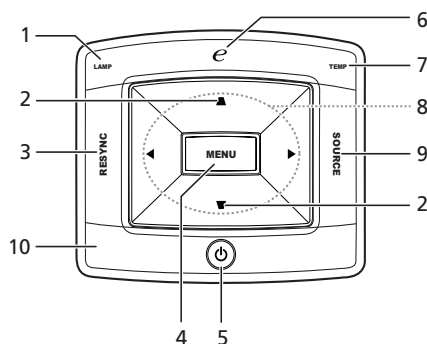

| #  | Function                     | Description   |
|----|------------------------------|---|
| 1  | LAMP                         | Lamp Indicator LED  |
| 2  | KEYSTONE                     | Adjusts the image to compensate for distortion caused by tilting the projector.   |
| 3  | RESYNC                       | Automatically synchronizes the projector to the input source.   |
| 4  | MENU                         | <ul style="list-style-type: none"> <li>Press "<b>MENU</b>" to launch the Onscreen display (OSD) menu, back to the previous step for the OSD menu operation or exit the OSD menu.</li> <li>Confirm your selection of items.</li> </ul> |
| 5  | POWER                        | See the contents in " <b>Turning the Projector On/Off</b> " section.  |
| 6  | Empowering key               | Unique Acer functions: eView, eTimer, e3D and ePower Management.  |
| 7  | TEMP                         | Temp Indicator LED  |
| 8  | Four directional select keys | Use to     select items or make adjustments to your selection.  |
| 9  | SOURCE                       | Changes the active source.  |
| 10 | IR Receiver                  | Remote control receiver.  |

## Remote Control Layout

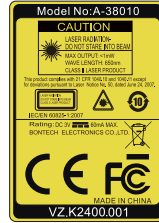
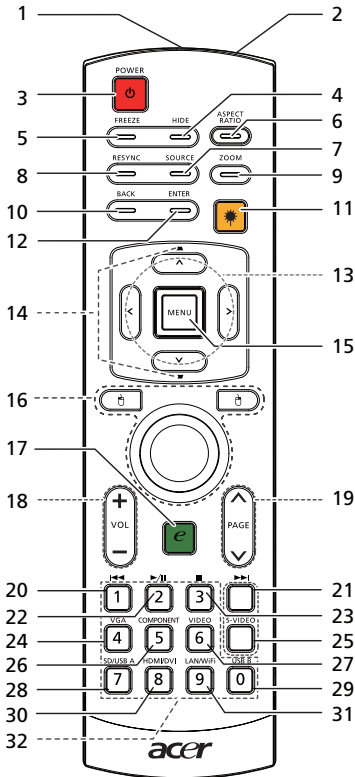

| #    | Icon | Function             | Description   |
|------|------|----------------------|---|
| 1    |      | Infrared transmitter | Sends signals to the projector.   |
| 2(#) |      | Laser pointer        | Aim the remote at the viewing screen.   |
| 3    |      | POWER                | Please see " <b>Turning the Projector On/Off</b> " section.   |
| 4    |      | HIDE                 | Temporarily turns off the video. Press " <b>HIDE</b> " to hide the image, press again to display the image. |
| 5    |      | FREEZE               | Pause the screen image.   |
| 6    |      | ASPECT RATIO         | Choose the desired aspect ratio (Auto/4:3/16:9)   |
| 7    |      | SOURCE               | Press " <b>SOURCE</b> " to choose from RGB, Component, S-Video, Composite, HDTV and HDMI™ sources.          |
| 8    |      | RESYNC               | Automatically synchronizes the projector to the input source.   |
| 9    |      | ZOOM                 | Zooms the projector display in or out.  |
| 10   |      | Back                 | Press " <b>BACK</b> " to go back one menu step.   |



| #     | Icon | Function                     | Description   |
|-------|------|------------------------------|---|
| 11(#) |      | Laser button                 | Aim the remote at the viewing screen, press and hold this button to activate the laser pointer. This function is not supported in Japanese market.  |
| 12    |      | Enter                        | No function.  |
| 13    |      | Four directional select keys | Use up, down, left, right buttons to select items or make adjustments to your selection.  |
| 14    |      | KEYSTONE                     | Adjusts the image to compensate for distortion caused by tilting the projector ( $\pm 40$ degrees).   |
| 15    |      | MENU                         | <ul style="list-style-type: none"> <li>Press "<b>MENU</b>" to launch the Onscreen display (OSD) menu, back to the previous step for the OSD menu operation or exit the OSD menu.</li> <li>Confirm your selection of items.</li> </ul> |
| 16    |      | MOUSE Left/Right Click       | Left-/right-click buttons are on the left and right, respectively; the center button works as a multidirectional pointer stick. To enable this function, a USB cable must be connected to projector from your PC.                     |
| 17    |      | Empowering key               | Unique Acer functions: eView, eTimer, e3D and ePower Management.  |
| 18    |      | VOLUME                       | Increases/decreases the volume.   |
| 19    |      | PAGE                         | For computer mode only. Use this button to select the next or previous page. This function is only available when connected to a computer via a USB cable.  |
| 20    |      | Prev                         | No function.  |
| 21    |      | Next                         | No function.  |
| 22    |      | Play/Pause                   | No function.  |
| 23    |      | Stop                         | No function.  |
| 24    |      | VGA                          | Press " <b>VGA</b> " to change source to the VGA connector. This connector supports analog RGB, YPbPr (480p/576p/720p/1080i), YCbCr (480i/576i) and RGBsync.  |
| 25    |      | S-VIDEO                      | To change source to S-Video.  |
| 26    |      | COMPONENT                    | Press " <b>COMPONENT</b> " to change source to Component video. This connection supports YPbPr (480p/576p/720p/1080i) and YCbCr (480i/576i).  |
| 27    |      | VIDEO                        | To change source to COMPOSITE VIDEO.  |
| 28    |      | SD/USB A                     | No function.  |
| 29    |      | USB B                        | No function.  |
| 30    |      | HDMI™/DVI                    | Press " <b>HDMI™/DVI</b> " to change source to HDMI™/DVI.   |
| 31    |      | LAN/WiFi                     | No function.  |
| 32    |      | KeyPad 0~9                   | Press " <b>0~9</b> " to input a password in the " <b>Security</b> ".  |



**Note:** "#" Japan area is not supported.

# Getting Started

## Connecting the Projector

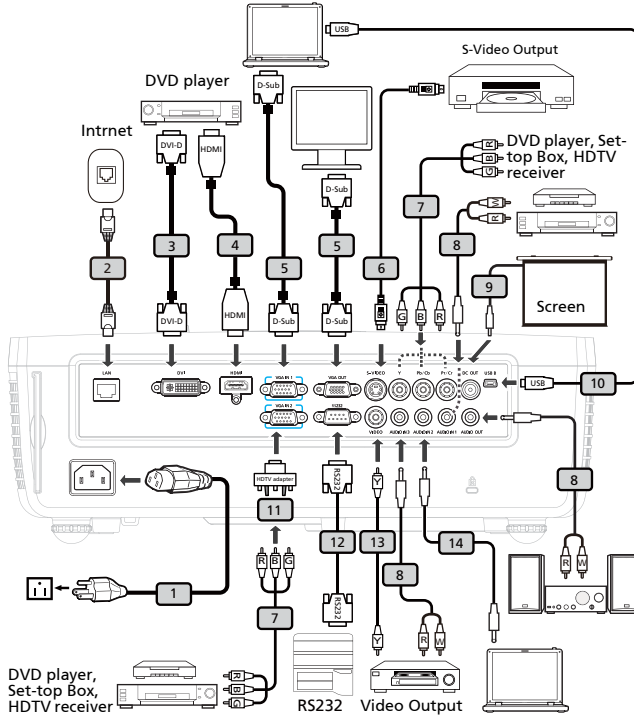

| # | Description           | #  | Description                   |
|---|-----------------------|----|-------------------------------|
| 1 | Power cord            | 8  | Audio cable Jack/RCA          |
| 2 | LAN cable             | 9  | 12V DC cable                  |
| 3 | DVI cable             | 10 | USB cable                     |
| 4 | HDMI cable            | 11 | VGA to component/HDTV adapter |
| 5 | VGA cable             | 12 | RS232 cable                   |
| 6 | S-Video cable         | 13 | Composite video cable         |
| 7 | 3 RCA component cable | 14 | Audio cable jack/jack         |



**Note:** To ensure the projector works well with your computer, please make sure the timing of the display mode is compatible with the projector.

# Turning the Projector On/Off

## Turning on the Projector

- 1 Remove the lens cap.(Illustration #1)
- 2 Ensure that the power cord and signal cable are securely connected. The Power indicator LED will flash red.
- 3 Turn on the projector by pressing "**Power**" button on the control panel, and the Power indicator LED will turn blue.(Illustration #2)
- 4 Turn on your source (computer, notebook, video player, etc.). The projector will detect your source automatically.
  - If the screen displays "Lock" and "Source" icons, it means the projector is locked onto a specific source type and there is no such type of input signal detected.
  - If the screen displays "No Signal", please make sure the signal cables are securely connected.
  - If you connect to multiple sources at the same time, use the "Source" button on either control panel or the remote control or direct source key on the remote control to switch between inputs.

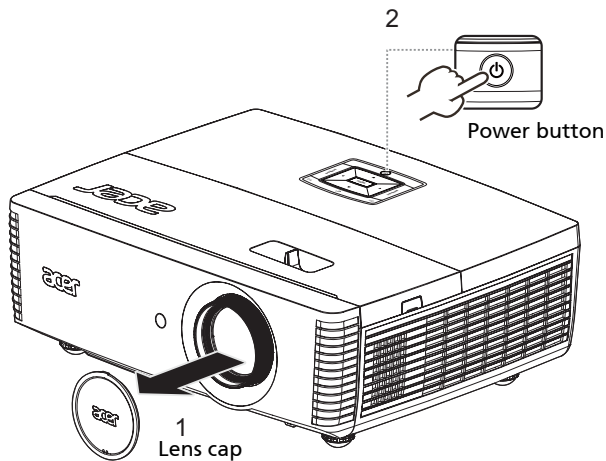

## Turning the projector off

- 1 To turn the projector off, press the power button. This message appears: **"Please press the power button again to complete the shutdown process."** Press the power button again.
- 2 The LED power indicator will turn RED and blink rapidly after the projector is turned off, and the fan(s) will continue to operate for about 2 minutes to ensure that the system cools properly. (only supported under "Instant Resume" mode)
- 3 As long as the power cord remains plugged in, you can press the power button to turn the projector immediately back on anytime during the 2-minute shutdown process. (only supported under "Instant Resume" mode)
- 4 Once the system has finished cooling, the LED power indicator will stop blinking and turn solid red to indicate standby mode.
- 5 It is now safe to unplug the power cord.



### Warning indicators:

- **"Projector Overheated. Lamp will automatically turn off soon."**  
This onscreen message indicates that the projector has overheated. The lamp will automatically turn off, the projector will automatically shut down, and the LED temp indicator will turn solid red. Contact your local dealer or service center.
- **"Fan failed. Lamp will automatically turn off soon."**  
This onscreen message indicates that the fan has failed. The lamp will automatically turn off, the projector will automatically shut down, and the LED temp indicator will blink. Contact your local dealer or service center.



**Note:** Whenever the projector automatically shuts down and the LED lamp indicator turns solid red, contact your local reseller or service center.

# Adjusting the Projected Image

## Adjusting the Height of Projected Image

The projector is equipped with tilt adjusting wheels for adjusting the height of image.

To raise/lower the image:

- 1 Use Tilt adjusting wheels to fine-tune the display angle.

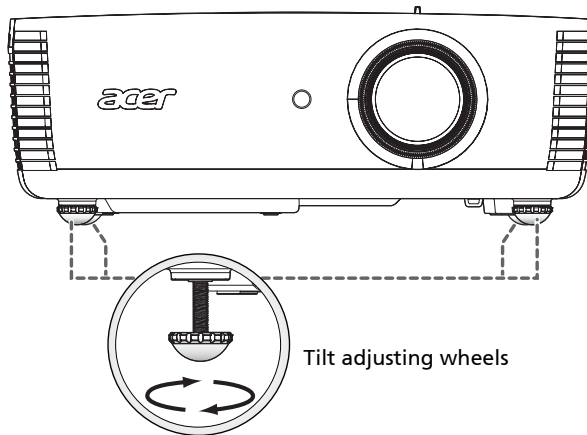

## How to optimize image size and distance

Consult the table below to find the optimal image sizes achievable when the projector is positioned at a desired distance from the screen. Example: If the projector is 2.5 m from the screen, good image quality is possible for image sizes between 51" and 62".



**Note:** Remind as below figure, the space of 113 cm height is required when located at 2.5 m distance.

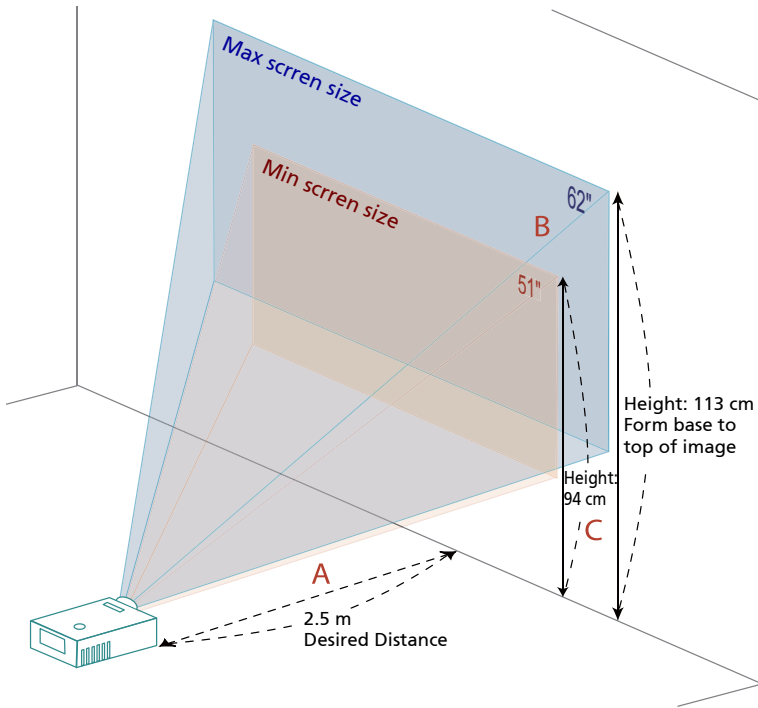
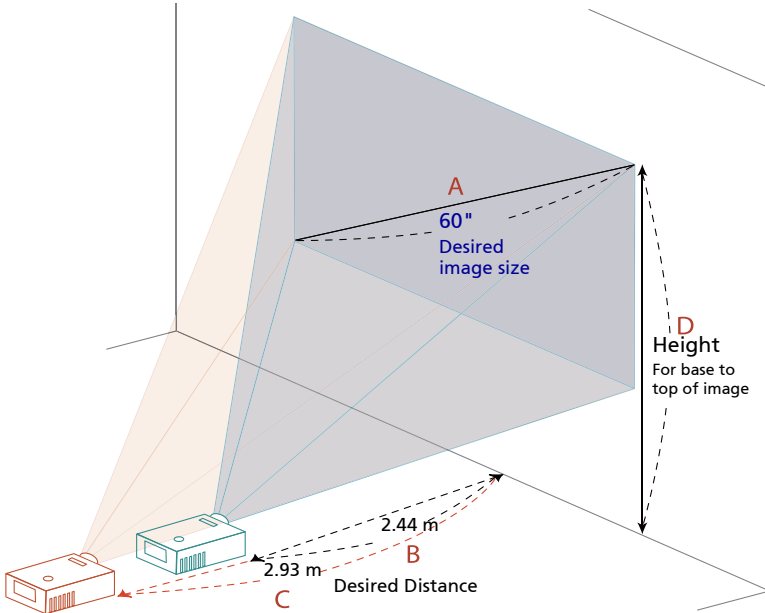

**Figure:** Fixed distance with different zoom and screen size.

| Desired Distance<br>(m)<br><A> | Screen size               |                 | Top                                   | Screen size               |                 | Top                                   |
|--------------------------------|---------------------------|-----------------|---------------------------------------|---------------------------|-----------------|---------------------------------------|
|                                | (Min zoom)                |                 |                                       | (Max zoom)                |                 |                                       |
|                                | Diagonal<br>(inch)<br><B> | W (cm) x H (cm) | From base to top of image (cm)<br><C> | Diagonal<br>(inch)<br><B> | W (cm) x H (cm) | From base to top of image (cm)<br><C> |
| 1.5                            | 31                        | 63 x 47         | 56                                    | 37                        | 75 x 56         | 68                                    |
| 2                              | 41                        | 83 x 63         | 75                                    | 49                        | 100 x 75        | 90                                    |
| 2.5                            | 51                        | 104 x 78        | 94                                    | 62                        | 125 x 94        | 113                                   |
| 3                              | 62                        | 125 x 94        | 113                                   | 74                        | 150 x 113       | 135                                   |
| 3.5                            | 72                        | 146 x 109       | 131                                   | 86                        | 175 x 131       | 158                                   |
| 4                              | 82                        | 167 x 125       | 150                                   | 98                        | 200 x 150       | 180                                   |
| 4.5                            | 92                        | 188 x 141       | 169                                   | 111                       | 225 x 169       | 203                                   |
| 5                              | 103                       | 208 x 156       | 188                                   | 123                       | 250 x 188       | 225                                   |
| 6                              | 123                       | 250 x 188       | 225                                   |                           |                 |                                       |

Zoom Ratio: 1.2x

## How to get a preferred image size by adjusting distance and zoom



The table below shows how to achieve a desired image size by adjusting either the position or the zoom ring. For example: to obtain an image size of 60" set the projector at a distance 2.44 m and 2.93 m from the screen and adjust the zoom level accordingly.



| Screen size               |                 | Distance (m)    |                 | Top (cm)                            |
|---------------------------|-----------------|-----------------|-----------------|-------------------------------------|
| Diagonal<br>(inch)<br><A> | W (cm) x H (cm) | Max zoom<br><B> | Min zoom<br><C> | From base to top of<br>image<br><D> |
| 30                        | 61 X 46         | 1.22            | 1.46            | 55                                  |
| 40                        | 81 X 61         | 1.63            | 1.95            | 73                                  |
| 50                        | 102 X 76        | 2.03            | 2.44            | 91                                  |
| 60                        | 122 X 91        | 2.44            | 2.93            | 110                                 |
| 70                        | 142 X 107       | 2.84            | 3.41            | 128                                 |
| 80                        | 163 X 122       | 3.25            | 3.90            | 146                                 |
| 90                        | 183 X 137       | 3.66            | 4.39            | 165                                 |
| 100                       | 203 X 152       | 4.06            | 4.88            | 183                                 |
| 120                       | 244 X 183       | 4.88            | 5.85            | 219                                 |

Zoom Ratio: 1.2x

# User Controls

## Installation menu

The installation menu provides an onscreen display (OSD) for projector installation and maintenance. Use the OSD only when the message "No signal input" is displayed on the screen.

The menu options include settings and adjustments for screen size and distance, focus, keystone correction and more .

- 1 Turn on the projector by pressing "Power" button on the control pad.
- 2 Press the menu button on the control pad to launch the OSD for projector installation and maintenance.

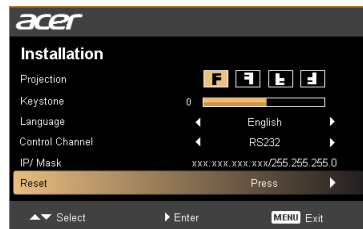
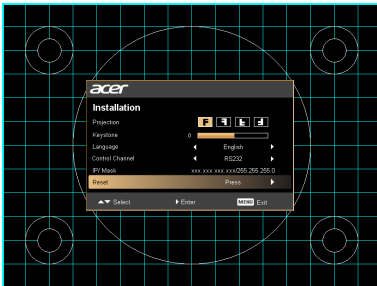

- 3 The background pattern acts as a guide to adjusting the calibration and alignment settings, such as screen size and distance, focus and more .
- 4 The Installation menu includes the following options:
  - Projection method
  - Keystone settings
  - Language settings
  - Control Channel settings
  - IP / Mask settings
  - Reset to factory default function

Use the up and down arrow keys to select an option, the left and right arrow keys to adjust selected option settings, and the right arrow key to enter a submenu for feature setting. The new settings will be saved automatically upon exiting the menu.



- 5 Push the menu button anytime to exit the menu and return to the Acer welcome screen.

## Acer Empowering Technology

Acer Empowering Key provide four Acer unique functions, they are "Acer eView Management", "Acer eTimer Management", "Acer ePower Management" and "Acer e3D Management" respectively.

Press "e" key to launch the Onscreen display main menu to modify its function.



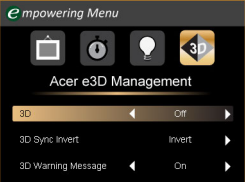



When the Empowering Menu is displayed, use the "e" key to select the main menu.

|   |  |
|---|--|
| <p><b>Acer eView Management</b></p>    | <p>"Acer eView Management" is for display mode selection. Please refer to Onscreen Display Menus section for more detail.</p>                                  |
| <p><b>Acer eTimer Management</b></p>   | <p>"Acer eTimer Management" provides the reminding function for presentation time control. Please refer to Onscreen Display Menus section for more detail.</p> |
| <p><b>Acer ePower Management</b></p>  | <p>"Acer ePower Management" provides user one shortcut to save the projector life. Please refer to Onscreen Display section for more detail.</p>               |
| <p><b>Acer e3D Management</b></p>    | <p>"Acer e3D Management" provides the 3D functions. Please refer to Onscreen Display Menus section for more detail.</p>  |

## Onscreen Display (OSD) Menus

The projector has multilingual OSD that allow you to make image adjustments and change a variety of settings.

### Using the OSD menus

- To open the OSD menu, press **"MENU"** on the remote control or control panel.
- When the OSD is displayed, use the   keys to select any item in the main menu. After selecting the desired main menu item, press  to enter submenu for feature setting.
- Use the   keys to select the desired item and adjust the settings by using the   keys.
- Select the next item to be adjusted in the submenu and adjust as described above.
- Press **"MENU"** on the remote control or control panel, the screen will return to the main menu.
- To exit OSD, press **"MENU"** on the remote control or control panel again. The OSD menu will close and the projector will automatically save the new settings.

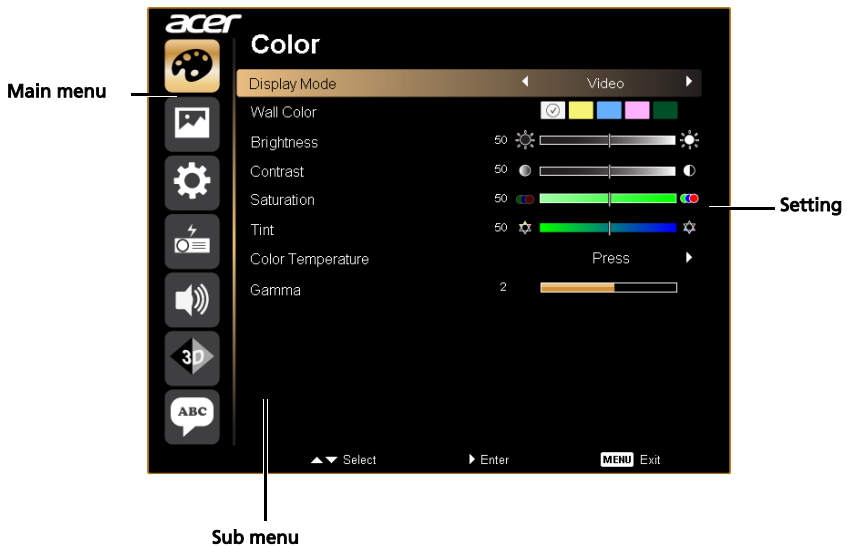

# Color

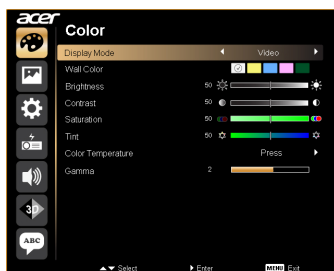

|              |   |
|--------------|---|
| Display Mode | <p>There are many factory presets optimized for various types of images.</p> <ul style="list-style-type: none"> <li>• Bright: For brightness optimization.</li> <li>• Presentation: For meeting presentation.</li> <li>• Standard: For common environment.</li> <li>• Video: For playing video in a bright environment.</li> <li>• User: Memorize user's settings.</li> </ul> |
| Wall color   | <p>Use this function to choose a proper color according to the wall. There are several choices, including white, light yellow, light blue, pink, dark green. It will compensate the color deviation due to the wall color to show the correct image tone.</p>   |
| Brightness   | <p>Adjust the brightness of the image.</p> <ul style="list-style-type: none"> <li>• Press ◀ to darken image.</li> <li>• Press ▶ to lighten the image.</li> </ul>  |
| Contrast     | <p>"Contrast" controls the difference between the lightest and darkest parts of the picture. Adjusting the contrast changes the amount of black and white in the image.</p> <ul style="list-style-type: none"> <li>• Press ◀ to decrease the contrast.</li> <li>• Press ▶ to increase the contrast.</li> </ul>  |
| Saturation   | <p>Adjusts a video image from black and white to fully saturated color.</p> <ul style="list-style-type: none"> <li>• Press ◀ to decrease the amount of color in the image.</li> <li>• Press ▶ to increase the amount of color in the image.</li> </ul>  |
| Tint         | <p>Adjusts the color balance of red and green.</p> <ul style="list-style-type: none"> <li>• Press ◀ to increase the amount of green in the image.</li> <li>• Press ▶ to increase the amount of red in the image.</li> </ul>   |





|   |  |
|---|--|
| <p><b>Color Temperature</b></p>  | <p><b>Mode</b><br/>Use this function to choose CT1 (6500K), CT2 (Native CT), CT3 (7500K), User mode.</p> <p><b>R Gain</b><br/>Adjusts the red gain for color temperature optimization.</p> <p><b>G Gain</b><br/>Adjusts the green gain for color temperature optimization.</p> <p><b>B Gain</b><br/>Adjusts the blue gain for color temperature optimization.</p> <p><b>R Bias</b><br/>Adjusts the red bias for color temperature optimization.</p> <p><b>G Bias</b><br/>Adjusts the green bias for color temperature optimization.</p> <p><b>B Bias</b><br/>Adjusts the blue bias for color temperature optimization.</p> |
| <p><b>Gamma</b></p>   | <p>Effects the representation of dark scenery. With greater gamma value, dark scenery looks brighter.</p>  |



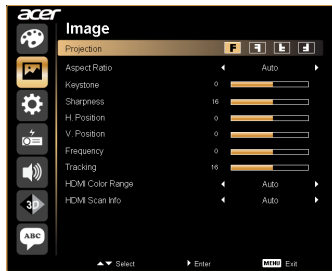

**Note:** "Saturation" and "Tint" functions are not supported under computer or HDMI mode.

## Image



|  |  |
|--|--|
| <p><b>Projection</b></p>  | <p><b>Front-Desktop</b></p> <ul style="list-style-type: none"> <li>The factory default setting.</li> </ul>   |
|                           | <p><b>Rear-Desktop</b></p> <ul style="list-style-type: none"> <li>When you select this function, the projector reverses the image so you can project from behind a translucent screen.</li> </ul>  |
|                           | <p><b>Rear-Ceiling</b></p> <ul style="list-style-type: none"> <li>When you select this function, the projector reverses and inverts the image at same time. You can project from behind a translucent screen with ceiling mounted projection.</li> </ul> |
|                           | <p><b>Front-Ceiling</b></p> <ul style="list-style-type: none"> <li>When you select this function, the projector inverts the image for ceiling-mounted projection.</li> </ul>   |

|   |   |
|---|---|
| <p><b>Aspect Ratio</b></p> <p>4:3      16:9</p>  | <p>Use this function to choose your desired aspect ratio.</p> <ul style="list-style-type: none"> <li>• Auto: Keep the image with original width-height ratio and maximize the image to fit native horizontal or vertical pixels.</li> <li>• 4:3: The image will be scaled to fit the screen and displayed using a 4:3 ratio.</li> <li>• 16:9: The image will be scaled to fit the width of the screen and the height adjusted to display the image using a 16:9 ratio.</li> </ul> |
| <p><b>Keystone</b></p>  | <p>Adjust image distortion caused by tilting projection. (<math>\pm 40</math> degrees)</p>   |
| <p><b>Sharpness</b></p>   | <p>Adjusts the sharpness of the image.</p> <ul style="list-style-type: none"> <li>• Press ◀ to decrease the sharpness.</li> <li>• Press ▶ to increase the sharpness.</li> </ul>   |
| <p><b>H. Position<br/>(Horizontal position)</b></p>   | <ul style="list-style-type: none"> <li>• Press ◀ to move the image left.</li> <li>• Press ▶ to move the image right.</li> </ul>   |
| <p><b>V. Position<br/>(Vertical position)</b></p>   | <ul style="list-style-type: none"> <li>• Press ◀ to move the image down.</li> <li>• Press ▶ to move the image up.</li> </ul>  |
| <p><b>Frequency</b></p>   | <p>"Frequency" changes the projector's refresh rate to match the frequency of your computer's graphics card. If you can see a vertical flickering bar in the projected image, use this function to make the necessary adjustments.</p>  |
| <p><b>Tracking</b></p>  | <p>Synchronizes the signal timing of the projector with the graphics card. If you experience an unstable or flickering image, use this function to correct it.</p>  |
| <p><b>HDMI Color Range</b></p>  | <p>Adjust the color range of the HDMI image data to correct color display error.</p> <ul style="list-style-type: none"> <li>• Auto: Automatically adjust by information from player.</li> <li>• Limited Range: Process the input image as limited color range data.</li> <li>• Full Range: Process the input image as full color range data.</li> </ul>   |
| <p><b>HDMI Scan Info</b></p>  | <p>Adjust the overscan ratio of the HDMI image on screen.</p> <ul style="list-style-type: none"> <li>• Auto: Automatically adjust by information from player.</li> <li>• Underscan: Always no overscan on HDMI image.</li> <li>• Overscan: Always keep overscan on HDMI image.</li> </ul>   |





**Note:** "H. Position", "V. Position", "Frequency" and "Tracking" functions are not supported under HDMI, DVI or Video mode.



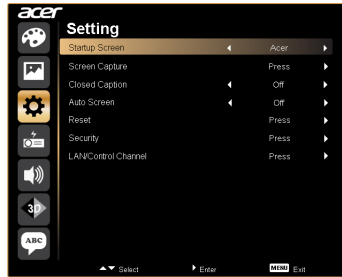



**Note:** "HDMI Color Range" and "HDMI Scan Info" functions are only supported under HDMI mode.

# Setting



|   |   |
|---|---|
| Startup Screen  | <p>Use this function to select your desired startup screen. If you change the setting, the changes will take effect when you exit the OSD menu.</p> <ul style="list-style-type: none"> <li>• Acer: The default startup screen of your Acer projector.</li> <li>• User: Use memorize picture from "Screen Capture" function.</li> </ul>  |
| <p>Screen Capture</p>  | <p>Use this function to customize the startup screen. To capture the image that you want to use as the startup screen, follow the instructions below.</p> <p><b>Notice:</b></p> <p>Before proceeding with the following steps, make sure that the "Keystone" is set to the default value 0 and the aspect ratio is set to 4:3. For details, refer to the "Image" section.</p> <ul style="list-style-type: none"> <li>• Change the "Startup Screen" from the default setting "Acer" to "User".</li> <li>• Press "Screen Capture" to customize the startup screen.</li> <li>• A dialog box appears to confirm the action. Choose "Yes" to use the current image as your customized startup screen. The capture range is the red rectangular area. Choose "No" to cancel the screen capture and exit the onscreen display (OSD).</li> <li>• A message appears, stating that the screen capture is in progress.</li> <li>• When the screen capture is finished, the message disappears and the original display is shown.</li> <li>• The customized startup screen, as shown below, takes effect when there is a new input signal or when you restart the projector.</li> </ul> |
| Closed Caption  | <p>Selects a preferred closed captioning mode from CC1, CC2, CC3, CC4, (CC1 displays captions in the primary language in your area). Select "Off" to turn off the captioning feature. This function is only available when a composite video or S-Video input signal is selected and its system format is NTSC.</p> <p>&lt;Note&gt; Set your screen aspect ratio to 4:3. This function is not available when the aspect ratio is "16:9" or "Auto" .</p>   |
| Auto Screen   | <ul style="list-style-type: none"> <li>• Default is On, the down/up move of electronic screen will be related with power on/off of Projector</li> </ul>   |
| Reset   | <ul style="list-style-type: none"> <li>• Press the  button and choose "Yes" to return the parameters on all menus to the factory default settings.</li> </ul>  |





|  |  |
|--|--|
|   | <p><b>Security</b></p> <p>This projector provides a useful security function for the administrator to manage usage of the projector .</p> <p>Press  to change the "Security" setting. If the security function is enabled, you must enter the "Administrator Password" first before changing the security settings.</p> <ul style="list-style-type: none"> <li>• Select "On" to enable the security function. The user has to enter a password to operate the projector. Please refer to the "User Password" section for details.</li> <li>• If "Off" is selected, then the user can turn on the projector without password.</li> </ul>   |
|  | <p><b>Timeout(Min.)</b></p> <p>Once "Security" is activated to "On", the administrator can set timeout function.</p> <ul style="list-style-type: none"> <li>• Press  or  to select the timeout interval.</li> <li>• The range is from 10 minute to 990 minutes.</li> <li>• When the time is up, the projector will prompt the user to enter the password again.</li> <li>• The factory default setting of "Timeout(Min.)" is "Off".</li> <li>• Once the security function is enabled, the projector will request user to enter password when switch on the projector . Both "User Password" and "Administrator Password" can be accepted for this dialogue.</li> </ul>   |
|  | <p><b>User password</b></p> <ul style="list-style-type: none"> <li>• Press  to setup or change the "User Password".</li> <li>• Press number keys to set your password on the remote control and press "MENU" to confirm.</li> <li>• Press  to delete character.</li> <li>• Enter the password when you see "Confirm Password" displayed.</li> <li>• The password should be between 4 and 8 characters long.</li> <li>• If you select "Request password only when plugging the power cord in.", the projector will prompt the user to enter the password every time the power cord is plugged.</li> <li>• If you select "Always request the password when turning the projector on.", the user has to enter the password every time when the projector is turned on.</li> </ul> |



**Note:** This screen capture function is limited by 4:3 aspect ratio only.

**Note:** For XGA models, to get best quality for you desired image, suggest end-user set PC resolution to 1024 x 768 before you use this function.

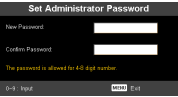
**Note:** For WXGA models, to get best quality for you desired image, suggest end-user set PC resolution to 1280 x 800 before you use this function.

|  |  |
|--|--|
|                               | <p><b>Administrator Password</b></p> <p>The "Administrator Password" can be used in both the "Enter Administrator Password" and "Enter Password" dialog boxes.</p> <ul style="list-style-type: none"> <li>Press  to change the "Administrator Password".</li> <li>The factory default of "Administrator Password" is "1234".</li> </ul> <p>If you forgot your administrator password, do the following to retrieve the administrator password:</p> <ul style="list-style-type: none"> <li>An unique 6-digit "Universal Password" which is printed on the Security Card (please check accessory in the box). This unique password is the number which will be accepted by projector anytime no matter what the Administrator Password is.</li> <li>If losing this security card and number, please contact with an Acer service center.</li> </ul> |
|  | <p><b>Lock User Startup Screen</b></p> <ul style="list-style-type: none"> <li>Default Lock User Startup Screen is "OFF". If lock user startup screen is "ON", users cannot change startup screen anymore and avoid other users change that arbitrarily. Choose "OFF" to unlock startup screen.</li> </ul>  |
| <p>LAN / Control Channel</p>  | <p><b>Control Channel</b></p> <ul style="list-style-type: none"> <li>LAN: If "Control Channel" is set to "LAN", "VGA OUT (Standby)" will automatically be set to "On" (default).</li> <li>RS232: If "Control Channel" is set to "RS232", you can choose "On" or "Off" in "VGA OUT (Standby)".</li> </ul>   |
|  | <p><b>VGA OUT (Standby)</b></p> <p>Default is "Off". Choose "On" to enable VGA OUT connection.</p>   |
|  | <p><b>IP/Mask</b></p> <p>Identify IP and Mask address.</p>   |
|  | <p><b>Default Gateway</b></p> <p>Display the default gateway.</p>  |
|  | <p><b>DNS Server</b></p> <p>Display the Domain Name System server.</p>   |
|  | <p><b>LAN Reset</b></p> <p>Reset the LAN function.</p>   |



## Management

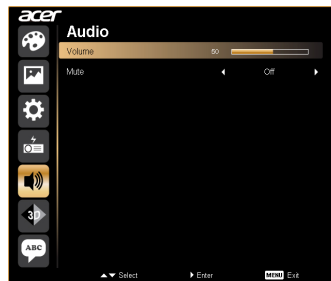

|                  |   |
|------------------|---|
| ECO Mode         | Choose "On" to dim the projector lamp which will lower power consumption, extend the lamp life and reduce noise. Choose "Off" to return normal mode.  |
| High Altitude    | Choose "On" to turn on High Altitude mode. Operate the fans at full speed continuously to allow for proper high altitude cooling of the projector.  |
| Turn Off Mode    | <ul style="list-style-type: none"> <li>Instant Resume: Resumes the system when the Power button is pressed again within 2 minutes.</li> <li>Instant Off: Shuts down the projector without fan cooling.</li> </ul> |
| Auto Shutdown    | The projector will automatically shutdown when there is no signal input after the allocated time. (default is 120 minutes)  |
| Lamp Hour Elapse | Displays the lamp's elapsed operating time (in hours).  |
| Lamp Reminding   | Activate this function to display a reminder to change the lamp 30 hours before its expected end-of-life.   |
| Lamp Hour Reset  | Press the  button and choose "Yes" to turn the lamp hour counter to 0 hours.   |

## Audio



|        |  |
|--------|--|
| Volume | <ul style="list-style-type: none"> <li>Press  to decrease the volume.</li> <li>Press  to increase the volume.</li> </ul> |
| Mute   | <ul style="list-style-type: none"> <li>Choose "On" to mute the volume.</li> <li>Choose "Off" to restore the volume.</li> </ul>   |

## 3D



|                    |  |
|--------------------|--|
| 3D                 | <p>Choose "On" to enable DLP 3D function.</p> <ul style="list-style-type: none"> <li>On: Choose this item while using DLP 3D glasses, 120Hz 3D capable graphics cards and HQFS format file or DVD with corresponding SW player.</li> <li>Off: Turn off 3D mode.</li> </ul>   |
| 3D Sync Invert     | <p>If you see a discrete or overlapping image while wearing DLP 3D glasses, you may need to execute "Invert" to get best match of left/right image sequence to get the correct image (for DLP 3D).</p>   |
| 3D Warning Message | <p>Choose "On" to display the 3D warning message.</p> <div data-bbox="370 730 863 858" style="border: 1px solid black; padding: 5px;"> <p>Note: 3D display is now enabled.</p> <ol style="list-style-type: none"> <li>1. Please make sure you have the correct 3D signals and glasses.</li> <li>2. Remember to turn 3D off if you don't want to see 3D images.</li> <li>3. If the 3D display isn't correct, please try to enable 3D Sync Invert.</li> <li>4. Display mode options will be disabled while in 3D mode.</li> </ol> </div> |



**Note:** It needs correct settings on graphic card 3D application program for correct 3D display.

**Note:** The SW players, such as Stereoscopic Player and DDD TriDef Media Player can support 3D format files. You can download these three players on web page below,

- Stereoscopic Player (Trial): [http://www.3dtv.at/Downloads/Index\\_en.aspx](http://www.3dtv.at/Downloads/Index_en.aspx)

- DDD TriDef Media Player (Trial):

<http://www.tridef.com/download/TriDef-3-D-Experience-4.0.2.html>

**Note:** "3D Sync Invert" is only available when 3D is enabled.

**Note:** There has reminder screen if 3D still enable when power on projector. Please adjust setting depended on your purpose.

# Language



## Language

Choose the multilingual OSD menu. Use the ▲ or ▼ key to select your preferred menu language.

- Press ▶ to confirm the selection.

# Appendices

## Troubleshooting

If you experience a problem with your Acer projector, refer to the following troubleshooting guide. If the problem persists, please contact your local reseller or service center.

### Image Problems and Solutions

| # | Problem  | Solution  |
|---|--|---|
| 1 | No image appears onscreen  | <ul style="list-style-type: none"> <li>• Connected as described in the "Getting Started" section.</li> <li>• Ensure none of the connector pins are bent or broken.</li> <li>• Check if the projector lamp has been securely installed. Please refer to the "Replacing the Lamp" section.</li> <li>• Make sure you have removed the lens cap and the projector is switched on.</li> </ul>  |
| 2 | Partial, scrolling or incorrectly displayed image(For PC (Windows 2000/XP/ Vista/Windows 7)) | <ul style="list-style-type: none"> <li>• Press "RESYNC" on the remote control or control panel.</li> <li>• For an incorrectly displayed image:             <ul style="list-style-type: none"> <li>• Open "My Computer," open the "Control Panel," and then double-click the "Display" icon.</li> <li>• Select the "Settings" tab.</li> <li>• Verify that your display resolution setting is lower than or equal to UXGA (1600 x 1200).</li> <li>• Click the "Advanced Properties" button.</li> </ul> </li> </ul> <p>If the problem still appears, change the monitor display you are using and follow the steps below:</p> <ul style="list-style-type: none"> <li>• Verify that the resolution setting is lower than or equal to UXGA (1600 x 1200).</li> <li>• Click the "Change" button under the "Monitor" tab.</li> <li>• Click "Show all devices". Next, select "Standard monitor types" under the SP box, and choose the resolution mode you need under the "Models" box.</li> <li>• Verify that the resolution setting of the monitor display is lower than or equal to UXGA (1600 x 1200).</li> </ul> |

|   |   |  |
|---|---|--|
| 3 | Partial, scrolling or incorrectly displayed image (for notebooks)       | <ul style="list-style-type: none"> <li>• Press "RESYNC" on the remote control or control panel.</li> <li>• For an incorrectly displayed image: <ul style="list-style-type: none"> <li>• Follow the steps for item 2 (above) to adjust the resolution of your computer.</li> <li>• Press the toggle output settings. Example: [Fn]+[F4], Compaq [Fn]+[F4], Dell [Fn]+[F8], Gateway [Fn]+[F4], IBM [Fn]+[F7], HP [Fn]+[F4], NEC [Fn]+[F3], Toshiba [Fn]+[F5]</li> </ul> </li> <li>• If you experience difficulty changing resolutions or your monitor freezes, restart all equipment including the projector.</li> </ul> |
| 4 | The screen of the notebook computer is not displaying your presentation | <ul style="list-style-type: none"> <li>• If you are using a Microsoft® Windows® based notebook: Some notebook PCs may deactivate their own screens when a second display device is in use. Each has a different way to be reactivated. Refer to your computer's manual for detailed information.</li> <li>• If you are using an Apple® Mac® OS based notebook: In System Preferences, open Display and select Video Mirroring "On".</li> </ul>   |
| 5 | Image is unstable or flickering   | <ul style="list-style-type: none"> <li>• Adjust the "Tracking" to correct it. Refer to the "Image" section for more information.</li> <li>• Change the display color depth settings on your computer.</li> </ul>   |
| 6 | Image has vertical flickering bar                                       | <ul style="list-style-type: none"> <li>• Use "Frequency" to make an adjustment. Refer to the "Image" section for more information.</li> <li>• Check and reconfigure the display mode of your graphics card to make it compatible with the projector.</li> </ul>  |
| 7 | Image is out of focus   | <ul style="list-style-type: none"> <li>• Make sure the lens cap is removed.</li> <li>• Adjusts the focus ring on the projector lens.</li> <li>• Make sure the projection screen is within the required distance of 5.9 to 19.7 feet (1.8 to 6.0 meters) from the projector. Refer to the "How to Get a Preferred Image Size by Adjusting Distance and Zoom" section for more information.</li> </ul>   |
| 8 | Image is stretched when displaying a "widescreen" DVD title             | <p>When you play a DVD encoded in anamorphic or 16:9 aspect ratio you may need to adjust the following settings:</p> <ul style="list-style-type: none"> <li>• If you play a 4:3 format DVD title, please change the format to 4:3 in the projector OSD.</li> <li>• If the image is still stretched, you will also need to adjust the aspect ratio. Set up the display format to 16:9 (wide) aspect ratio on your DVD player.</li> </ul>  |

|    |                                 |  |
|----|---------------------------------|--|
| 9  | Image is too small or too large | <ul style="list-style-type: none"> <li>• Adjust the zoom ring on the top of the projector.</li> <li>• Move the projector closer to or further from the screen.</li> <li>• Press "MENU" on the remote control or on the control panel. Go to "Image --&gt; Aspect Ratio" and try different settings.</li> </ul>   |
| 10 | Image has slanted sides         | <ul style="list-style-type: none"> <li>• If possible, reposition the projector so that it is centered on the screen.</li> <li>• Press the "Keystone <math>\Delta</math> / <math>\nabla</math>" on the control panel or on the remote control until the sides are vertical.</li> <li>• Press the "Keystone" on the OSD until the sides are vertical.</li> </ul> |
| 11 | Image is reversed               | <ul style="list-style-type: none"> <li>• Select "Image --&gt; Projection" on the OSD and adjust the projection direction.</li> </ul>   |

### Problems with the Projector

| # | Condition                                      | Solution   |
|---|--|--|
| 1 | The projector stops responding to all controls | If possible, turn off the projector, then unplug the power cord and wait at least 30 seconds before reconnecting power.  |
| 2 | Lamp burns out or makes a popping sound        | When the lamp reaches the end of its useful life, it will burn out and may make a loud popping sound. If this happens, the projector will not turn on until the lamp module has been replaced. To replace the lamp, follow the procedures in the "Replacing the Lamp" section. |



## OSD Messages

| # | Condition | Message Reminder  |
|---|-----------|---|
| 1 | Message   | <p data-bbox="396 274 963 316">Fan Fail - the system fan is not working.</p> <div data-bbox="396 320 963 384" style="background-color: black; color: white; padding: 5px; text-align: center;"> <p data-bbox="647 328 712 347">Fan Fail.</p> <p data-bbox="544 351 822 370">Lamp will automatically turn off soon.</p> </div> <p data-bbox="396 400 963 528">Projector Overheated - the projector has exceeded its recommended operating temperature and must be allowed to cool down before it may be used. Please also check the dust filters if they are installed. If the dust filter is clogged with dust, please clean it. Please refer to "Cleaning and replacing the dust filter" for details.</p> <div data-bbox="396 552 963 616" style="background-color: black; color: white; padding: 5px; text-align: center;"> <p data-bbox="600 560 759 579">Projector Overheated.</p> <p data-bbox="544 582 822 601">Lamp will automatically turn off soon.</p> </div> <p data-bbox="396 632 963 673">Replace the lamp - the lamp is about to reach its maximum lifetime. Prepare to replace it soon.</p> <div data-bbox="396 697 963 761" style="background-color: black; color: white; padding: 5px; text-align: center;"> <p data-bbox="432 705 934 724">Lamp is approaching the end of its useful life in full power operation.</p> <p data-bbox="591 727 775 746">Replacement suggested!</p> </div> |

# LED & Alarm Definition Listing

## LED Messages

| Message                            | Lamp LED       | Temp LED       | Power LED      |                |
|------------------------------------|----------------|----------------|----------------|----------------|
|                                    | Red            | Red            | Red            | Blue           |
| Standby<br>(power cord plugged in) | --             | --             | V              | --             |
| Power button ON                    | --             | --             | --             | V              |
| Lamp retry                         | --             | --             | --             | Quick flashing |
| Turning off<br>(cooling state)     | --             | --             | Quick flashing | --             |
| Turning off<br>(cooling completed) | --             | --             | V              | --             |
| Error (thermal failure)            | --             | V              | --             | V              |
| Error (fan lock failure)           | --             | Quick flashing | --             | V              |
| Error (lamp breakdown)             | V              | --             | --             | V              |
| Error (color wheel fail)           | Quick flashing | --             | --             | V              |

# Cleaning and replacing the dust filters

## Cleaning the dust filters

Clean the dust filters after every 1000 hours of use. If they are not cleaned periodically, they can become clogged with dust, preventing proper ventilation. This can cause overheating and damage the projector.

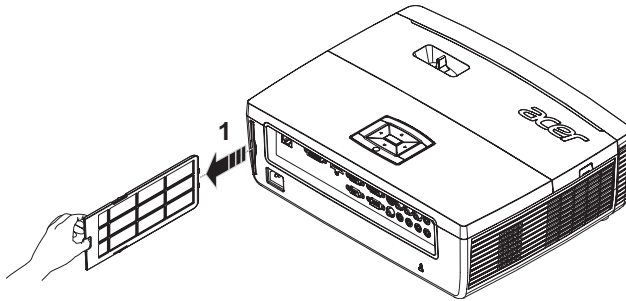

Follow these steps:

- 1 Turn the projector off. Wait for the Power LED to stop flashing then unplug the power cord.
- 2 Allow the projector at least 30 mins to cool down.
- 3 Pull out the dust filter (Illustration #1)
- 4 To clean the dust filters, use a small vacuum cleaner designed for computers and other office equipment.
- 5 If the dirt is difficult to remove or the filter is broken, please contact your local dealer or service center to obtain a new filter.



### To Change the Lamp

- 1 Turn off the projector by pressing the power button.
- 2 Allow the projector at least 30 mins to cool down.
- 3 Disconnect the power cord.
- 4 Open the screw covers on both sides of the projector. (Illustration #1)
- 5 Remove the two screws on both sides of the projector at the same time. (Illustration #2)
- 6 Open the top cover. (Illustration #3)
- 7 Remove the three screws that secure the lamp module (Illustration #4) and pull up the lamp bar.(Illustration #5)
- 8 Pull out the lamp module by force. (Illustration #6)

To replace the lamp module, reverse the previous step.



.....

**Warning:** To reduce the risk of personal injury, do not drop the lamp module or touch the lamp bulb. The bulb may shatter and cause injury if it is dropped.

## Ceiling Mount Installation

If you wish to install the projector using a ceiling mount, please refer to the steps below:

- 1 Drill four holes into a solid, structurally sound part of the ceiling, and secure the mount base.

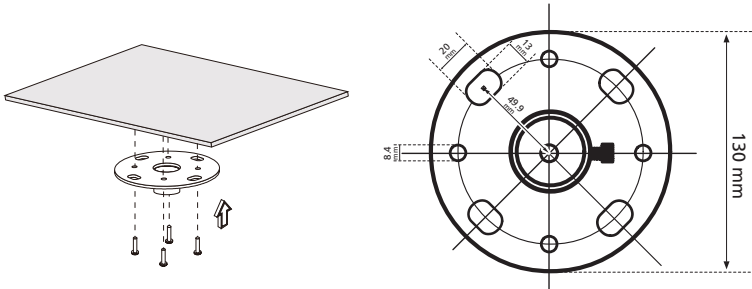

**Note:** Screws are not included. Please obtain the appropriate screws for your type of ceiling.

- 2 Secure the ceiling rod using the appropriate type of four-cylinder screws.

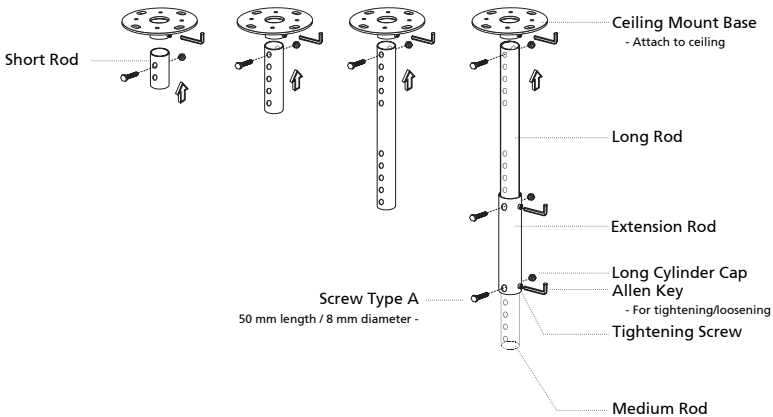

- 3 Use the appropriate number of screws for the projector size to attach the projector to the ceiling mount bracket.

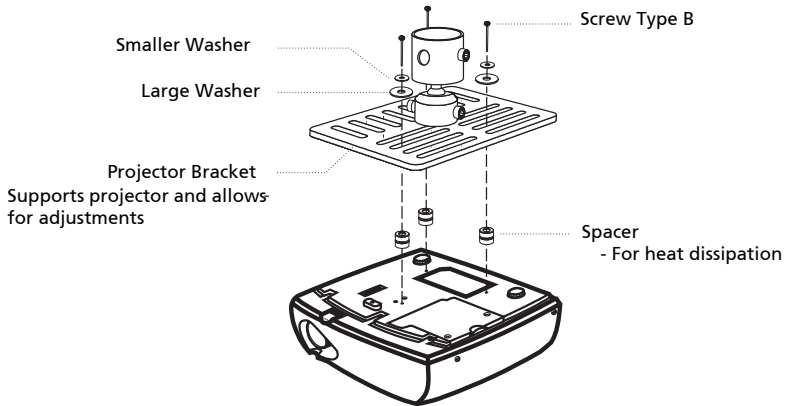

**Note:** It is recommended that you keep a reasonable space between the bracket and the projector to allow for proper heat distribution. Use two washers for extra support, if deemed necessary.

- 4 Attach the ceiling bracket to the ceiling rod.

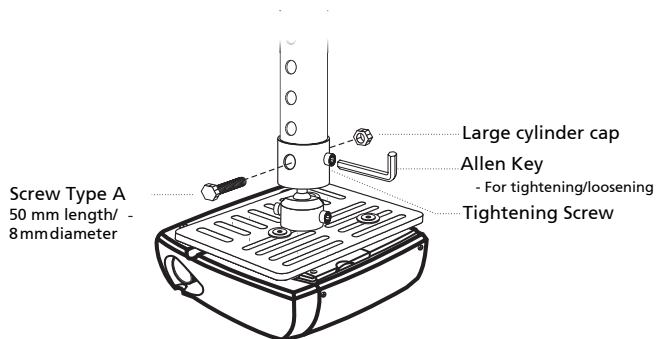

- 5 Adjust the angle and positioning as necessary.

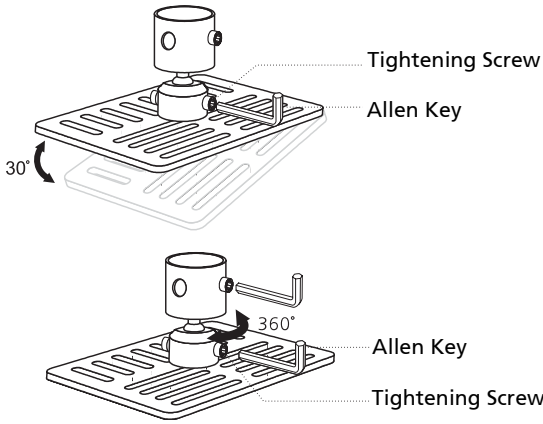

**Note:** The appropriate type of screw and washer for each model is listed in the table below. 3 mm diameter screws are enclosed in the screw pack.

| Models                                  | Screw Type B  |             | Washer Type |       |
|---|---------------|-------------|-------------|-------|
|   | Diameter (mm) | Length (mm) | Large       | Small |
| P7213/F213/PF-X14/<br>P7215/F217/PF-X16 | 3             | 25          | V           | V     |

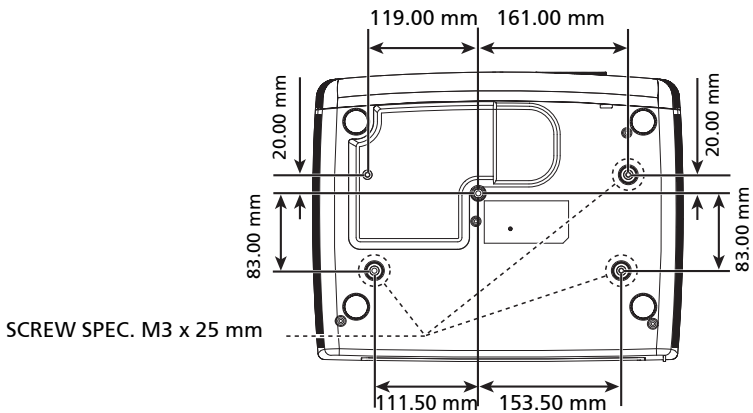



## Specifications

The specifications listed below are subject to change without notice. For final specs, please refer to Acer's published marketing specifications.

|                                   |   |
|-----------------------------------|---|
| Projection system                 | DLP®  |
| Resolution                        | Native: XGA (1024 x 768), Maximum: UXGA (1600 x 1200), WSXGA+ (1680 x 1050), 1080p (1920 x 1080)                        |
| Computer compatibility            | IBM PC and compatibles, Apple Macintosh, iMac and VESA standards: SXGA, XGA, VGA, SVGA, SXGA+, WXGA, WXGA+, WSXGA+      |
| Video compatibility               | NTSC (3.58/4.43), PAL (B/D/G/H/I/M/N), SECAM (B/D/G/K/K1/L), HDTV (720p, 1080i/p), EDTV (480p, 576p), SDTV (480i, 576i) |
| Aspect ratio                      | Auto, 4:3 (native), 16:9  |
| Displayable colors                | 1.07 billion colors   |
| Projection lens                   | F = 1.77 ~ 1.93, f = 28.64 mm ~ 34.35 mm, 1.2x manual zoom and manual focus   |
| Projection screen size (diagonal) | 37" (94 cm) - 123" (312 cm)   |
| Projection distance               | 5.9' (1.8 m) - 19.7' (6.0 m)  |
| Throw ratio                       | 60" @2.44 m (2.00 ~ 2.40:1)   |
| Horizontal scan rate              | 30 k - 100 kHz  |
| Vertical refresh scan rate        | 50 - 120 Hz   |
| Lamp type                         | P7213/F213/PF-X14: 300 W user-replaceable lamp<br>P7215/F217/PF-X16: 330 W user-replaceable lamp                        |
| Keystone correction               | +/- 40 degrees  |
| Audio                             | Internal speaker with 5 W x 2 output  |
| Weight                            | 6.5 kg (14.33 lbs.)   |
| Dimensions (W x D x H)            | 397.7 mm x 309.4 mm x 125.9 mm (15.7" x 12.2" x 5.0")   |
| Remote control                    | Laser pointer function (optional)   |
| Digital Zoom                      | 2x  |
| Power supply                      | AC input 100 - 240 V, 50 - 60 Hz  |
| Power consumption                 | P7123: 385 W ±10%<br>P7125: 435 W ±10%  |
| Operating temperature             | 5°C to 40°C / 41°F to 104°F   |

## I/O connectors

- Power socket x1
- VGA input x2
- Composite input x1
- S-Video x1
- VGA output x1
- HDMI x1
- DVI-D x1: with HDCP support
- RS232 x1
- USB x1
- 3.5 mm audio jack input x3
- 3.5 mm audio jack output x1
- 3 RCA Component video x1
- RJ45 x1
- DC Jack x1

---

Standard package contents

- AC power cord x1
  - VGA cable x1
  - Composite video cable x1
  - Remote control x1
  - Battery x 2 (for remote control)
  - User's Guide (CD-ROM) x1
  - Quick start guide x1
  - Security card x1
  - Carrying case x1
  - Dust filter x1
- 

\* Design and specifications are subject to change without notice.

# Compatibility modes

## A. VGA Analog

### 1 VGA Analog - PC Signal

| Modes         | Resolution | V.Frequency [Hz] | H.Frequency [KHz] |
|---------------|------------|------------------|-------------------|
| VGA           | 640x480    | 60               | 31.5              |
|               | 640x480    | 72               | 37.9              |
|               | 640x480    | 75               | 37.5              |
|               | 640x480    | 85               | 43.3              |
|               | 640x480    | 120              | 61.9              |
| SVGA          | 800x600    | 56               | 35.1              |
|               | 800x600    | 60               | 37.9              |
|               | 800x600    | 72               | 48.1              |
|               | 800x600    | 75               | 46.9              |
|               | 800x600    | 85               | 53.7              |
|               | 800x600    | 120              | 77.4              |
| XGA           | 1024x768   | 60               | 48.4              |
|               | 1024x768   | 70               | 56.5              |
|               | 1024x768   | 75               | 60.0              |
|               | 1024x768   | 85               | 68.7              |
|               | 1024x768   | 120              | 99.0              |
| SXGA          | 1152x864   | 70               | 63.8              |
|               | 1152x864   | 75               | 67.5              |
|               | 1152x864   | 85               | 77.1              |
|               | 1280x1024  | 60               | 64.0              |
|               | 1280x1024  | 72               | 77.0              |
|               | 1280x1024  | 75               | 80.0              |
| QuadVGA       | 1280x960   | 85               | 91.1              |
|               | 1280x960   | 60               | 60.0              |
|               | 1280x960   | 75               | 75.2              |
| SXGA+         | 1400x1050  | 60               | 65.3              |
| UXGA          | 1600x1200  | 60               | 75.0              |
| Power Mac G4  | 640x480    | 60               | 31.4              |
|               | 640x480    | 66.6(67)         | 34.9              |
|               | 800x600    | 60               | 37.9              |
|               | 1024x768   | 60               | 48.4              |
|               | 1152x870   | 75               | 68.7              |
|               | 1280x960   | 75               | 75.0              |
| i Mac DV (G3) | 1024x768   | 75               | 60.0              |

## 2 VGA Analog - Extended Wide timing

| Modes  | Resolution                                | V.Frequency [Hz] | H.Frequency [KHz] |
|--------|---|------------------|-------------------|
| WXGA   | 1280x768                                  | 60               | 47.8              |
|        | 1280x768                                  | 75               | 60.3              |
|        | 1280x768                                  | 85               | 68.6              |
|        | 1280x720                                  | 60               | 44.8              |
|        | 1280x800                                  | 60               | 49.6              |
| WSXGA+ | 1440x900                                  | 60               | 59.9              |
|        | 1680x1050                                 | 60               | 65.3              |
|        | 1920x1080<br>(Reduced<br>Blanking Timing) | 60               | 66.6              |
|        | 1366x768                                  | 60               | 47.7              |

## 3 VGA Analog -Component Signal

| Modes | Resolution            | V.Frequency [Hz] | H.Frequency [KHz] |
|-------|-----------------------|------------------|-------------------|
| 480i  | 720x480<br>(1440x480) | 59.94(29.97)     | 15.7              |
| 576i  | 720x576<br>(1440x576) | 50(25)           | 15.6              |
| 480p  | 720x480               | 59.94            | 31.5              |
| 576p  | 720x576               | 50               | 31.3              |
| 720p  | 1280x720              | 60               | 45.0              |
| 720p  | 1280x720              | 50               | 37.5              |
| 1080i | 1920x1080             | 60(30)           | 33.8              |
| 1080i | 1920x1080             | 50(25)           | 28.1              |
| 1080p | 1920x1080             | 60               | 67.5              |
| 1080p | 1920x1080             | 50               | 56.3              |

## B. HDMI Digital

### 1 HDMI - PC Signal

| Modes | Resolution | V.Frequency [Hz] | H.Frequency [KHz] |
|-------|------------|------------------|-------------------|
| VGA   | 640x480    | 60               | 31.5              |
|       | 640x480    | 72               | 37.9              |
|       | 640x480    | 75               | 37.5              |
|       | 640x480    | 85               | 43.3              |
|       | 640x480    | 120              | 61.9              |
| SVGA  | 800x600    | 56               | 35.1              |
|       | 800x600    | 60               | 37.9              |

|               |           |          |      |
|---------------|-----------|----------|------|
|               | 800x600   | 72       | 48.1 |
|               | 800x600   | 75       | 46.9 |
|               | 800x600   | 85       | 53.7 |
|               | 800x600   | 120      | 77.4 |
| XGA           | 1024x768  | 60       | 48.4 |
|               | 1024x768  | 70       | 56.5 |
|               | 1024x768  | 75       | 60.0 |
|               | 1024x768  | 85       | 68.7 |
|               | 1024x768  | 120      | 99.0 |
| SXGA          | 1152x864  | 70       | 63.8 |
|               | 1152x864  | 75       | 67.5 |
|               | 1152x864  | 85       | 77.1 |
|               | 1280x1024 | 60       | 64.0 |
|               | 1280x1024 | 72       | 77.0 |
|               | 1280x1024 | 75       | 80.0 |
|               | 1280x1024 | 85       | 91.1 |
| QuadVGA       | 1280x960  | 60       | 60.0 |
|               | 1280x960  | 75       | 75.2 |
| SXGA+         | 1400x1050 | 60       | 65.3 |
| UXGA          | 1600x1200 | 60       | 75.0 |
| PowerBook G4  | 640x480   | 60       | 31.4 |
|               | 640x480   | 66.6(67) | 34.9 |
|               | 800x600   | 60       | 37.9 |
|               | 1024x768  | 60       | 48.4 |
|               | 1152x870  | 75       | 68.7 |
|               | 1280x960  | 75       | 75.0 |
| i Mac DV (G3) | 1024x768  | 75       | 60.0 |

## 2 HDMI - Extended Wide timing

| Modes  | Resolution                                | V.Frequency [Hz] | H.Frequency [KHz] |
|--------|---|------------------|-------------------|
| WXGA   | 1280x768                                  | 60               | 47.8              |
|        | 1280x768                                  | 75               | 60.3              |
|        | 1280x768                                  | 85               | 68.6              |
|        | 1280x720                                  | 60               | 44.8              |
|        | 1280x800                                  | 60               | 49.6              |
| WSXGA+ | 1440x900                                  | 60               | 59.9              |
|        | 1680x1050                                 | 60               | 65.3              |
|        | 1920x1080<br>(Reduced Blanking<br>Timing) | 60               | 66.6              |
|        | 1366x768                                  | 60               | 47.7              |

## 3 HDMI - Video Signal

| Modes                                  | Resolution               | V.Frequency [Hz] | H.Frequency [KHz] |
|--|--------------------------|------------------|-------------------|
| 480i                                   | 720x480<br>(1440x480)    | 59.94(29.97)     | 15.7              |
| 576i                                   | 720x576<br>(1440x576)    | 50(25)           | 15.6              |
| 480p                                   | 720x480                  | 59.94            | 31.5              |
| 576p                                   | 720x576                  | 50               | 31.3              |
| 720p                                   | 1280x720                 | 60               | 45.0              |
| 720p                                   | 1280x720                 | 50               | 37.5              |
| 1080i                                  | 1920x1080                | 60(30)           | 33.8              |
| 1080i                                  | 1920x1080                | 50(25)           | 28.1              |
| 1080p                                  | 1920x1080                | 60               | 67.5              |
| 1080p                                  | 1920x1080                | 50               | 56.3              |
| Graphic source<br>monitor range limits | Horizontal scan<br>rate: | 30k-100kHz       |                   |
|  | Vertical scan<br>rate:   | 50-120Hz         |                   |
|  | Max. pixel rate          | 162MHz           |                   |

# Regulations and safety notices

## FCC notice

This device has been tested and found to comply with the limits for a Class B digital device pursuant to Part 15 of the FCC rules. These limits are designed to provide reasonable protection against harmful interference in a residential installation. This device generates, uses, and can radiate radio frequency energy and, if not installed and used in accordance with the instructions, may cause harmful interference to radio communications.

However, there is no guarantee that interference will not occur in a particular installation. If this device does cause harmful interference to radio or television reception, which can be determined by turning the device off and on, the user is encouraged to try to correct the interference by one or more of the following measures:

- Reorient or relocate the receiving antenna.
- Increase the separation between the device and receiver.
- Connect the device into an outlet on a circuit different from that to which the receiver is connected.
- Consult the dealer or an experienced radio/television technician for help.

## Notice: Shielded cables

All connections to other computing devices must be made using shielded cables to maintain compliance with FCC regulations.

## Notice: Peripheral devices

Only peripherals (input/output devices, terminals, printers, etc.) certified to comply with the Class B limits may be attached to this equipment. Operation with non-certified peripherals is likely to result in interference to radio and TV reception.

## Caution

Changes or modifications not expressly approved by the manufacturer could void the user's authority, which is granted by the Federal Communications Commission, to operate this device.

## Operation conditions

This device complies with Part 15 of the FCC Rules. Operation is subject to the following two conditions: (1) this device may not cause harmful interference, and (2) this device must accept any interference received, including interference that may cause undesired operation.

## Notice: Canadian users

This Class B digital apparatus complies with Canadian ICES-003.

## Remarque à l'intention des utilisateurs canadiens

Cet appareil numérique de la classe B est conforme à la norme NMB-003 du Canada.

## Declaration of Conformity for EU countries

Acer hereby declares that this projector series is in compliance with the essential requirements and other relevant provisions of Directive 1999/5/EC.

Compliant with Russian regulatory certification



ME61 UA.TR.002

## Radio device regulatory notice



**Note:** The regulatory information below is for models with wireless LAN and/or Bluetooth only.

## General

This product complies with the radio frequency and safety standards of any country or region in which it has been approved for wireless use. Depending on configurations, this product may or may not contain wireless radio devices (such as wireless LAN and/or Bluetooth modules).

## Canada — Low-power license-exempt radio communication devices (RSS-210)

- a Common information  
Operation is subject to the following two conditions:
  1. This device may not cause interference, and
  2. This device must accept any interference, including interference that may cause undesired operation of the device.
- b Operation in 2.4 GHz band  
To prevent radio interference to the licensed service, this device is intended to be operated indoors and installation outdoors is subject to licensing.

## List of applicable countries

This device must be used in strict accordance with the regulations and constraints in the country of use. For further information, please contact the local office in the country of use. Please see <http://ec.europa.eu/enterprise/rtte/implem.htm> for the latest country list.





**Acer Incorporated**  
8F, 88, Sec. 1, Xintai 5th Rd., Xizhi,  
New Taipei City 221, Taiwan



## Declaration of Conformity

We,

**Acer Incorporated**

8F, 88, Sec. 1, Xintai 5th Rd., Xizhi, New Taipei City 221, Taiwan

Contact Person: Mr. RU Jan, e-mail:ru\_jan@acer.com.tw

And,

**Acer Italy s.r.l**

Via Lepetit, 40, 20020 Lainate (MI) Italy

Tel: +39-02-939-921, Fax: +39-02 9399-2913, www.acer.it

Hereby declare that:

|                      |  |
|----------------------|--|
| <b>Product:</b>      | <b>Projector</b>                           |
| <b>Trade Name:</b>   | <b>Acer</b>                                |
| <b>Model Number:</b> | <b>DNX1117/DNX1118</b>                     |
| <b>Machine Type:</b> | <b>P7213/F213/PF-X14/P7215/F217/PF-X16</b> |

Is compliant with the essential requirements and other relevant provisions of the following EC directives, and that all the necessary steps have been taken and are in force to assure that production units of the same product will continue comply with the requirements.

### **EMC Directive 2004/108/EC as attested by conformity with the following harmonized standards:**

- EN55022, AS/NZS CISPR22, Class B
- EN55024
- EN61000-3-2 Class A
- EN61000-3-3

### **Low Voltage Directive 2006/95/EC as attested by conformity with the following harmonized standard:**

- EN60950-1

### **RoHS Directive 2002/95/EC on the Restriction of the Use of certain Hazardous Substances in Electrical and Electronic Equipment**

- The maximum concentration values of the restricted substances by weight in homogenous material are:

|                     |      |   |       |
|---------------------|------|---|-------|
| Lead                | 0.1% | Polybrominated Biphenyls (PBB's)        | 0.1%  |
| Mercury             | 0.1% | Polybrominated Diphenyl Ethers (PBDE's) | 0.1%  |
| Hexavalent Chromium | 0.1% | Cadmium                                 | 0.01% |

**Directive 2009/125/EC with regard to establishing a framework for the setting of ecodesign requirements for energy-related product.**



**Acer Incorporated**  
8F, 88, Sec. 1, Xintai 5th Rd., Xizhi,  
New Taipei City 221, Taiwan

**The standards listed below are applied to the product if built with WLAN module or wireless keyboard and mouse.**



**R&TTE Directive 1999/5/EC as attested by conformity with the following harmonized standard:**

● **Article 3.1(a) Health and Safety**

- EN60950-1
- EN62311

● **Article 3.1(b) EMC**

- EN301 489-1
- EN301 489-17

● **Article 3.2 Spectrum Usages**

- EN300 328
- EN301 893 (Applicable to 5GHz high performance RLAN).

**Year to begin affixing CE marking 2012.**

RU Jan/Sr. Manager  
Regulation Center, Acer Inc.

**Mar. 30, 2012** -  
Date



Acer America Corporation

333 West San Carlos St., San Jose  
CA 95110, U. S. A.  
Tel : 254-298-4000  
Fax : 254-298-4147  
www.acer.com



## Federal Communications Commission Declaration of Conformity

This device complies with Part 15 of the FCC Rules. Operation is subject to the following two conditions: (1) this device may not cause harmful interference, and (2) this device must accept any interference received, including interference that may cause undesired operation.

The following local Manufacturer / Importer is responsible for this declaration:

|                                      |   |
|--------------------------------------|---|
| <b>Product:</b>                      | DLP Projector   |
| <b>Model Number:</b>                 | DNX1117/DNX1118   |
| <b>Machine Type:</b>                 | P7213/F213/PF-X14/P7215/F217/PF-X16                       |
| <b>Name of Responsible Party:</b>    | Acer America Corporation                                  |
| <b>Address of Responsible Party:</b> | 333 West San Carlos St.<br>San Jose, CA 95110<br>U. S. A. |
| <b>Contact Person:</b>               | Acer Representative                                       |
| <b>Phone No.:</b>                    | 254-298-4000  |
| <b>Fax No.:</b>                      | 254-298-4147  |