

# quick installation guide

Dell™ B1265dfw Laser MFP



- DE Kurzinstallationsanleitung
- FR Guide d'installation rapide
- IT Guida di installazione rapida
- ES Guía rápida de instalación
- BR Manual de Instalação Rápida
- NL Beknopte installatiehandleiding
- SE Snabbinstallationsanvisning
- DK Lyninstallationsvejledning
- NO Hurtiginstallasjonsguide
- GR Οδηγός γρήγορης εγκατάστασης
- HU Gyors telepítési útmutató
- PL Skrócona instrukcja instalacji
- CZ Stručná instalační příručka
- CN 快速安装指南



## 1 Installing the toner cartridge

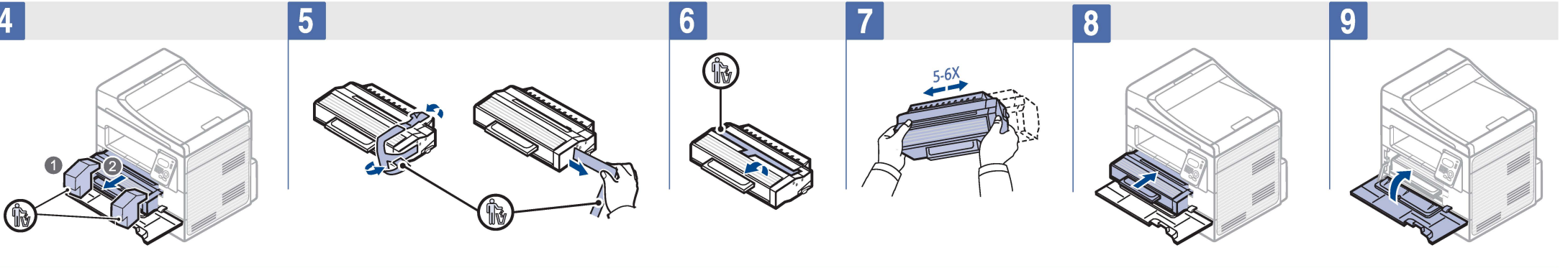
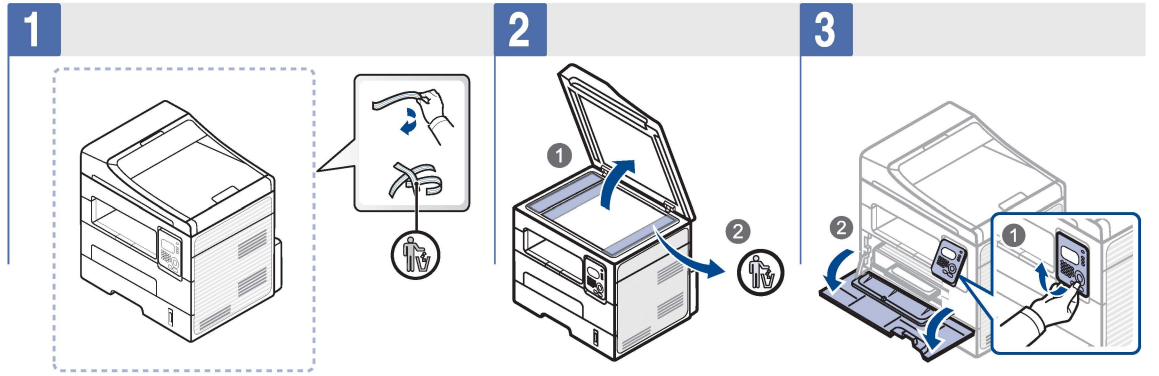
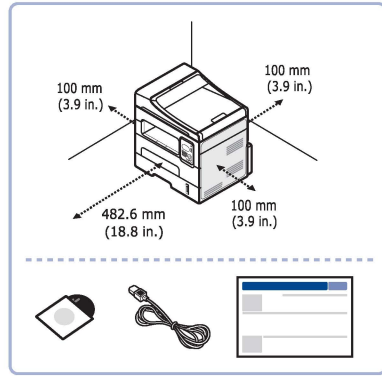
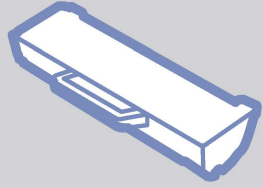

## 2 Loading Paper

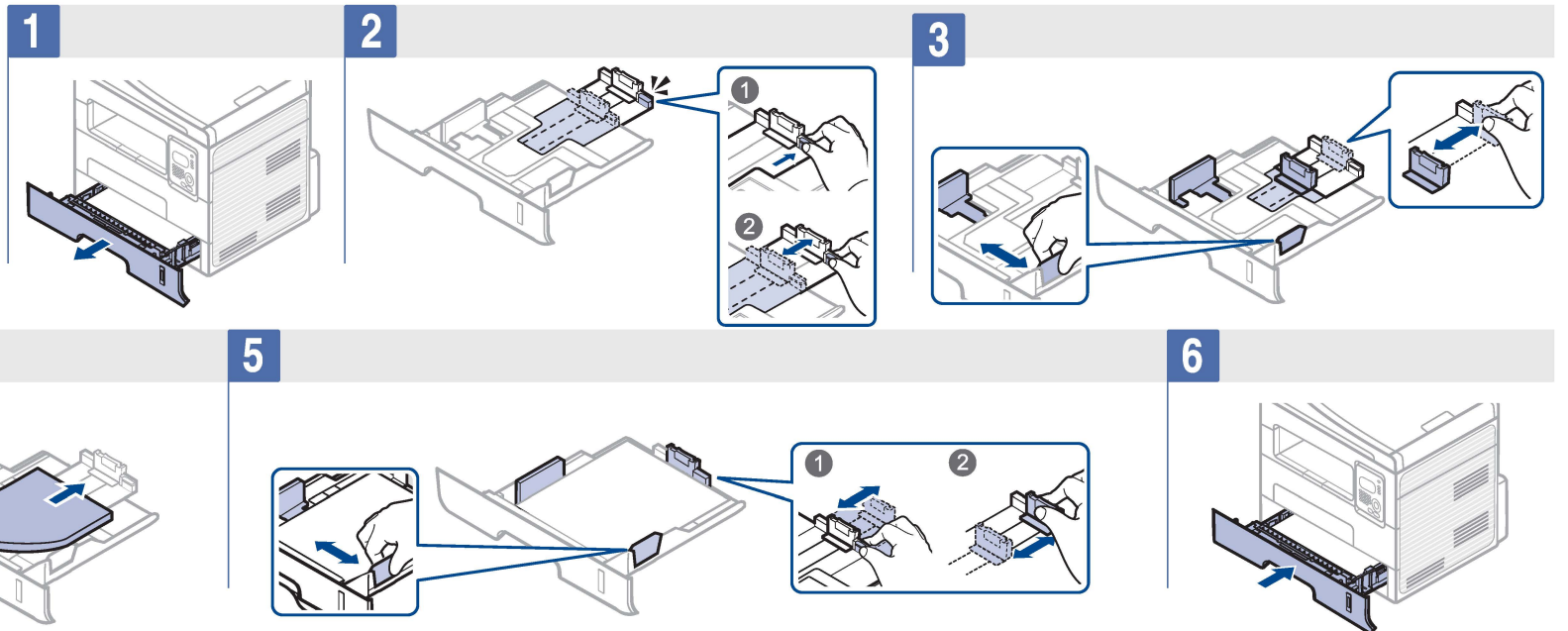
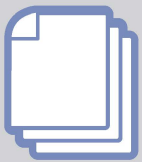

## 3 Connecting Cable

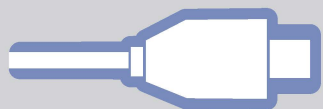

### Connecting Fax Line (fax user only)

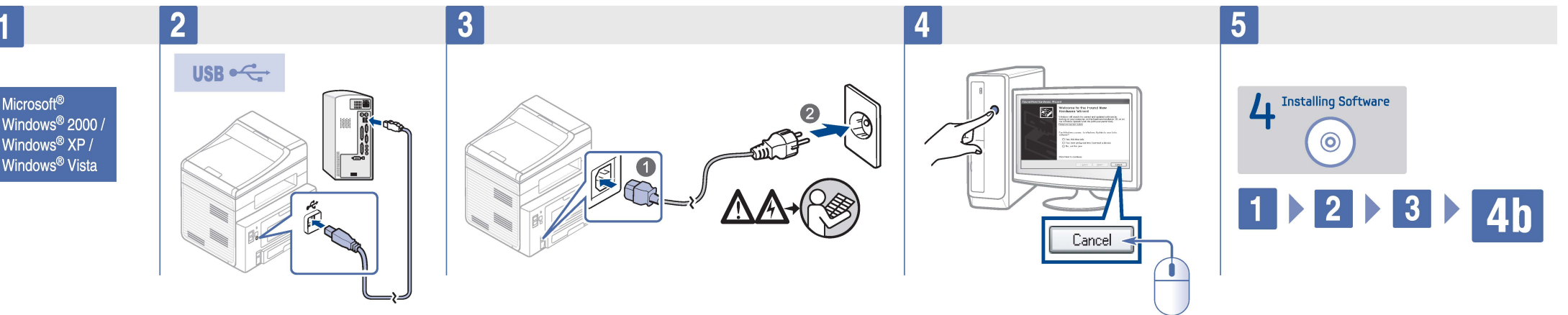
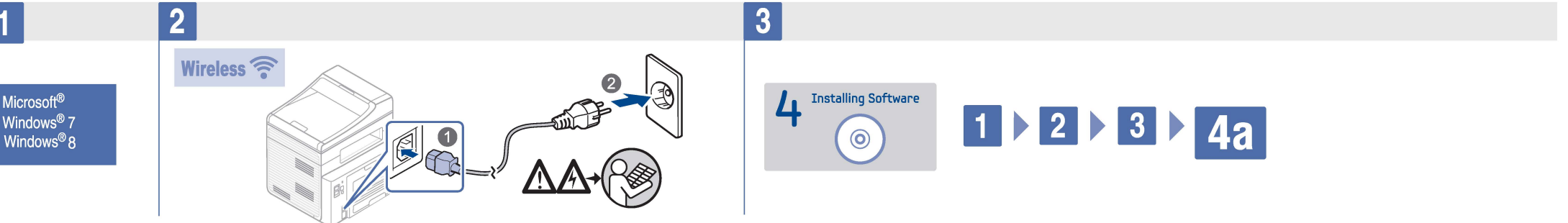
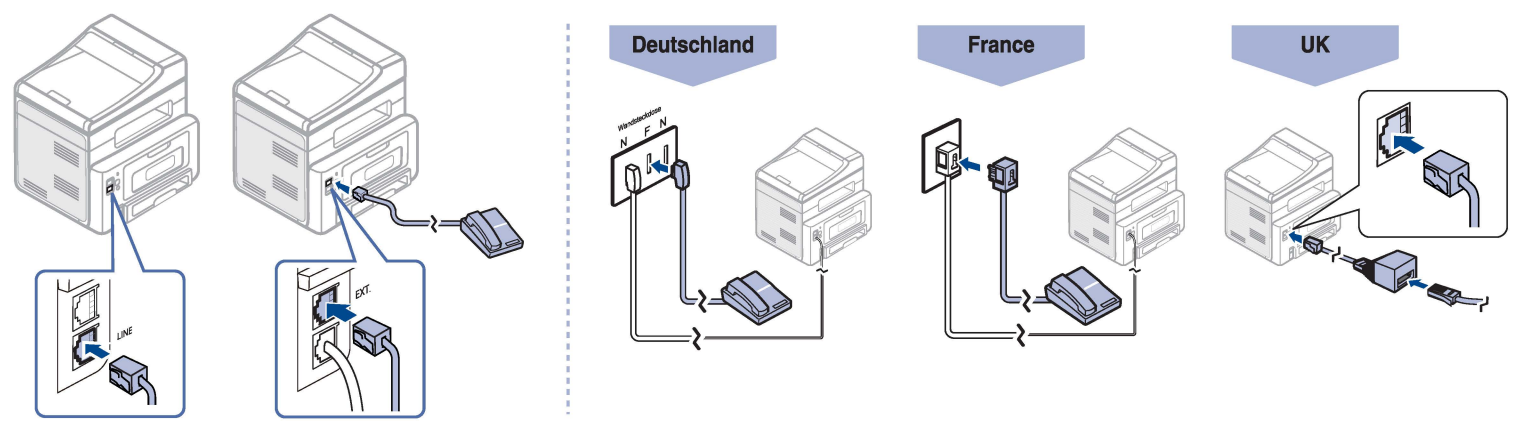



4

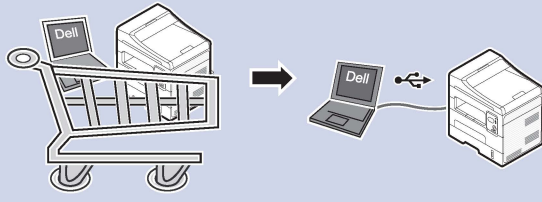

5 Viewing the User's Guide

## 4 Installing Software

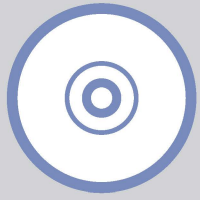

1

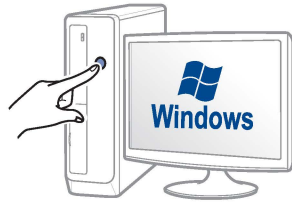

2

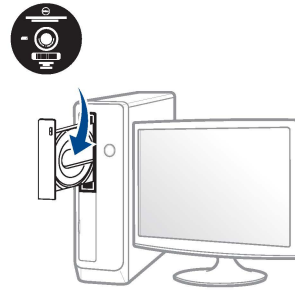

3

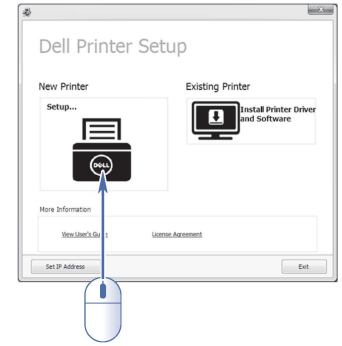

4a

Microsoft® Windows® 7  
Windows® 8

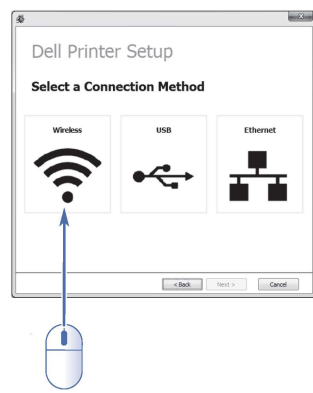

4b

Microsoft® Windows® 2000 /  
Windows® XP /  
Windows® Vista

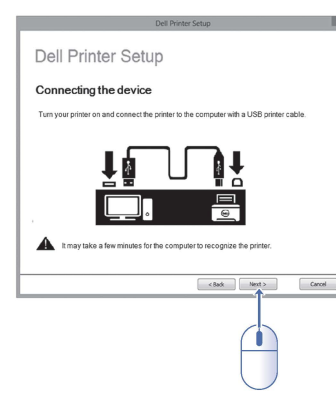
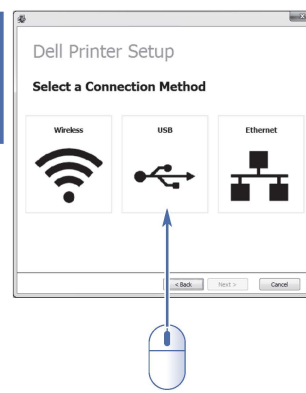
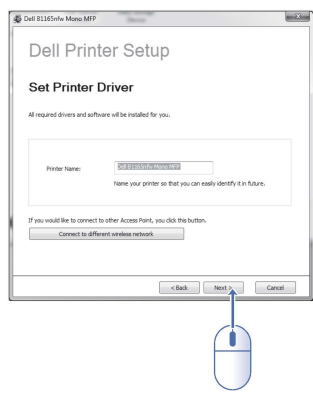

5

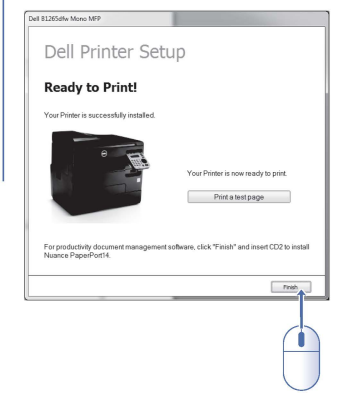

## 4 Alternatively

De manière alternative |  
Alternativamente | Alternative |  
Alternativamente | Alternativ |  
Alternativt | Eller | Alternativ | 或者



On your computer's browser, go to <http://www.dell.com/support>

Dans le navigateur de votre ordinateur, rendez-vous sur le site <http://www.dell.com/support>  
Nel browser del computer, visitare il sito <http://www.dell.com/support>  
Rufen Sie im Browser des Computers die Website <http://www.dell.com/support> auf  
En el navegador del ordenador, vaya a <http://www.dell.com/support>  
Gebruik de browser op uw computer om naar <http://www.dell.com/support> te gaan  
I din computers browser, skal du gå til <http://www.dell.com/support>  
I datamaskinens nettleser, gå til <http://www.dell.com/support>  
Starta datorns webbläsare och gå till <http://www.dell.com/support>  
在电脑浏览器上访问<http://www.dell.com/support>

Download from website  
Téléchargement depuis le site Web  
Scarica da sito Web  
Download von der Website  
Descargar del sitio web  
Downloaden via de website  
Download fra hjemmesiden  
Last ned fra webside  
Ladda ner från webbplats  
从网站下载



Follow on-screen instructions. Ready to use.



Suivez les instructions à l'écran. Prêt à être utilisé.  
Eseguire le istruzioni visualizzate. Pronta all'uso.  
Befolgen Sie die Anweisungen auf dem Bildschirm. Betriebsbereit.  
Siga las instrucciones en pantalla. Lista para el uso.  
Volg de instructies op het scherm. Klaar voor gebruik.  
Følg vejledningen på skærmen. Klar til brug.  
Følg anvisningene på skjermen. Klar for bruk.  
Följ anvisningarna på skärmen. Klar att användas.  
按照屏幕上的说明操作。准备就绪。

## 5 Viewing the User's Guide



- DE Lesen Sie das Benutzerhandbuch
- FR Afficher le guide d'utilisateur
- IT Visualizzazione della Guida dell'utente
- ES Ver el Manual de Usuario
- BR Exiba o Manual do Usuário
- NL Gebruikershandleiding weergeven
- SE Läs bruksanvisningen
- DK Få vist brugervejledningen

- NO Vis brukerhåndboken
- GR Προβολή του οδηγού χρήστη
- HU Olvassa el a Felhasználói útmutatót
- PL Przeglądanie podręcznika użytkownika
- CZ Prostudujte si uživatelskou příručku
- CN 查看用户指南

Ensure that you read the safety guidelines in the *Product Information Guide* before using this product.

- DE Lesen Sie vor der Benutzung dieses Produkts unbedingt das *Produktinformationshandbuch*.
- FR Veuillez à lire les instructions de sécurité du *Guide d'information sur le produit* avant d'utiliser ce produit.
- IT Prima di usare questo prodotto, assicurarsi di leggere le indicazioni per la sicurezza nella *Guida de informações do produto*.
- ES Asegúrese de leer las directrices de seguridad que se describen en *Guía de información del producto* antes de usar este producto.
- BR Certifique-se de ler as diretrizes de segurança no *Manual de Informações do Produto* antes de usar este produto.
- NL Lees de veiligheidsinstructies in de *Productinformatiegids* voordat u dit product gebruikt.
- SE Läs noggrant igenom säkerhetsråden i *Produktinformationsguiden* innan du använder produkten.
- DK Læs sikkerhedsretningslinjerne i *produktvejledningen*, før enheden tages i brug.
- NO Les sikkerhetsretningslinjene i heftet *Produktinformasjon* før du tar i bruk produktet.
- GR Διαβάστε πρώτα τις οδηγίες για την ασφάλεια στον *Οδηγό πληροφοριών προϊόντος* πριν χρησιμοποιήσετε το προϊόν.
- HU A termék használatá előtt mindenképpen olvassa el a *Termékmismertető kézikönyvben* található biztonsági óvintézkedéseket.
- PL Przed rozpoczęciem użytkowania tego produktu należy zapoznać się z zasadami bezpieczeństwa opisanymi w *Podręczniku informacji o produkcie*.
- CZ Než začnete tento produkt používat, přečtěte si nejprve *Příručku s informacemi o produktu*.
- CN 确保在使用本产品前阅读 *产品信息指南* 中的安全准则。

Information in this document is subject to change without notice.  
© 2013 Dell Inc. All rights reserved.

Reproduction of these materials in any manner whatsoever without the written permission of Dell Inc. is strictly forbidden. Trademarks used in this text: Dell and the DELL logo are trademarks of Dell Inc.

Other trademarks and trade names may be used in this document to refer to either the entities claiming the marks and names or their products. Dell Inc. disclaims any proprietary interest in trademarks and trade names other than its own.

May 2013  
Printed in China



[www.dell.com](http://www.dell.com) | [www.dell.com/support](http://www.dell.com/support)