



# **Voyager 5200 Office**

Bluetooth headset system for desk  
phone

User Guide

# Contents

Hook up system	3
Desk phone setup details	3
Position Your Base	5
Overview	6
Headset overview	6
Base overview	7
Accessories	7
Pair	8
Pair headset to base	8
Pair to mobile device	8
Pair mode	8
Fit and charge	9
Fit	9
Charge	10
Low battery warnings	10
Load software	11
Update firmware	11
The basics	12
Power on/off	12
Adjust volume	12
Make, answer, end calls	12
Use sensors	13
More Features	14
Play or pause audio	14
Voice assistant (smartphone feature)	14
Enable and use Amazon Alexa (smartphone feature)	14
Enable Tile	14
Troubleshooting	15
Headset	15
Desk phone	16
Support	17

# Hook up system

Using the diagram, connect your headset system.

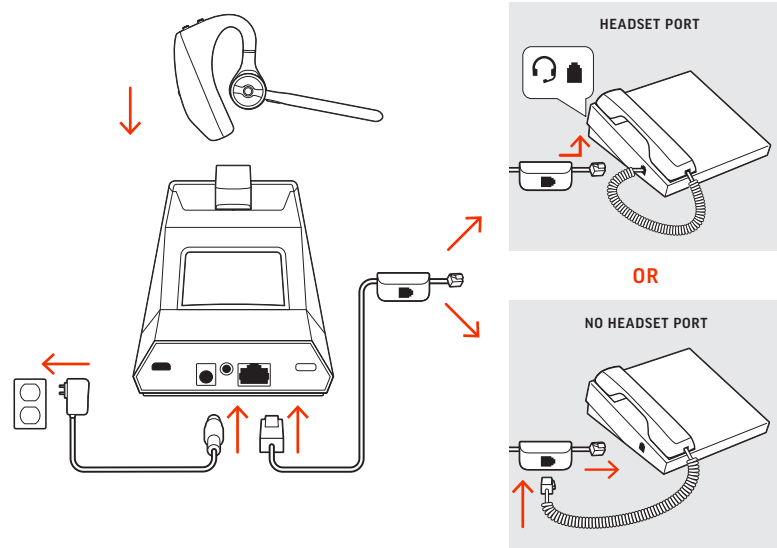

**NOTE** Base configuration settings

Desk phone	Setting (on bottom of base)
Most phones	A
Cisco phones	D
Cisco phones with EHS cable	A

## Desk phone setup details

Choose a desk phone setup **A, B, C or D** and connect cables.

**A** Desk phone with dedicated headset port

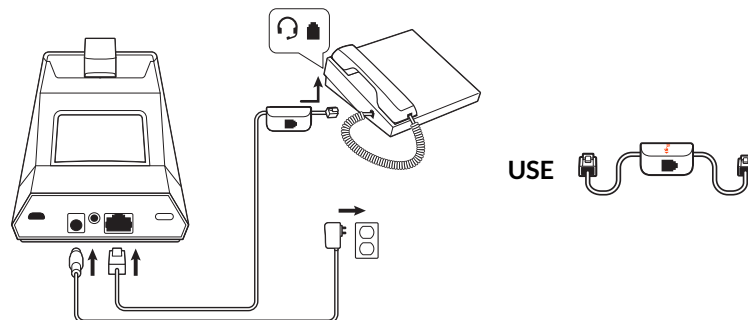

- Connect one end of the telephone interface cable to the back of the base
- Connect the other end of the telephone interface cable into the dedicated headset port on the desk phone

**IMPORTANT** Cisco phones use configuration **D** on the bottom of the base. Most other phones use default configuration **A**.

**NOTE** Use this setup if you are not using the HL10 lifter or EHS cable. In this configuration, press both the headset button on your desk phone and the call control button on the headset to answer or end calls.

B Desk phone (standard)

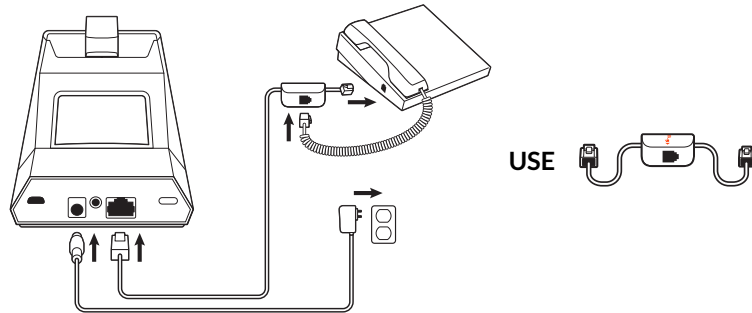

- Connect one end of the telephone interface cable to the back of the base
- Disconnect the handset coil cord from the base of the desk phone and re-connect it to the telephone interface cable junction box
- Finally connect the remaining end of the telephone interface cable into the open handset port on the desk phone

**IMPORTANT** Cisco phones use configuration D on the bottom of the base. Most other phones use default configuration A.

**NOTE** Use this setup if you are not using the HL10 lifter or EHS cable and your desk phone does not have a dedicated headset port. In this configuration, manually remove the handset on your desk phone and press the call control button on the headset to answer or end calls.

C Desk phone + EHS cable (sold separately)

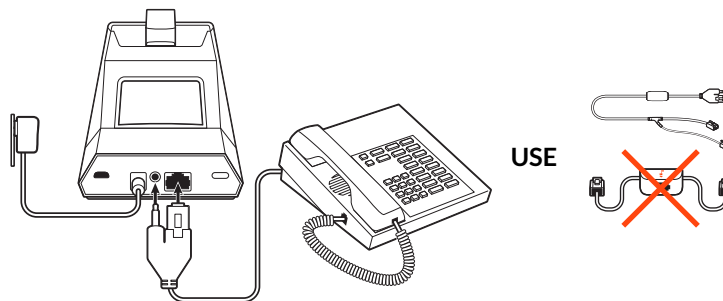

**IMPORTANT** Use configuration A on the bottom of the base, which works for most phones including Cisco phones.

D Desk phone + HL10 lifter (sold separately)

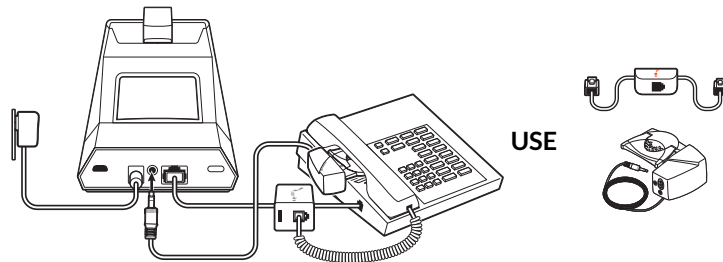

**IMPORTANT** Cisco phones use configuration D on the bottom of the base. Most other phones use default configuration A.

### Position Your Base

The minimum recommended separation between your desk phone and the base is 6 inches.

The minimum recommended separation between the base and computer is 12 inches. Incorrect position can cause noise and interference problems.

**NOTE** Headset cradle may vary, but function is the same.

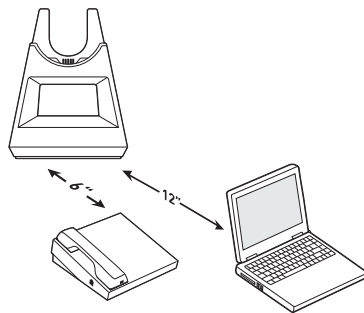

# Overview

## Headset overview

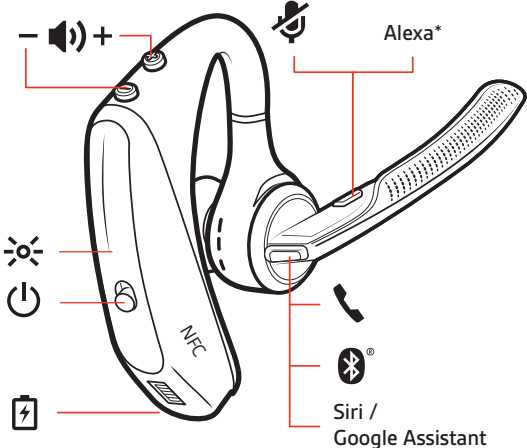

Icon	Headset control
	Volume
	Mute
	Call
	Bluetooth pairing
Siri, Google Assistant	Default voice assistant
NFC	Near Field Communication (available on select models)
	Charge port
	Power
	Indicator light

### Be safe

Please read the safety guide for important safety, charging, battery and regulatory information before using your new headset.

## Base overview

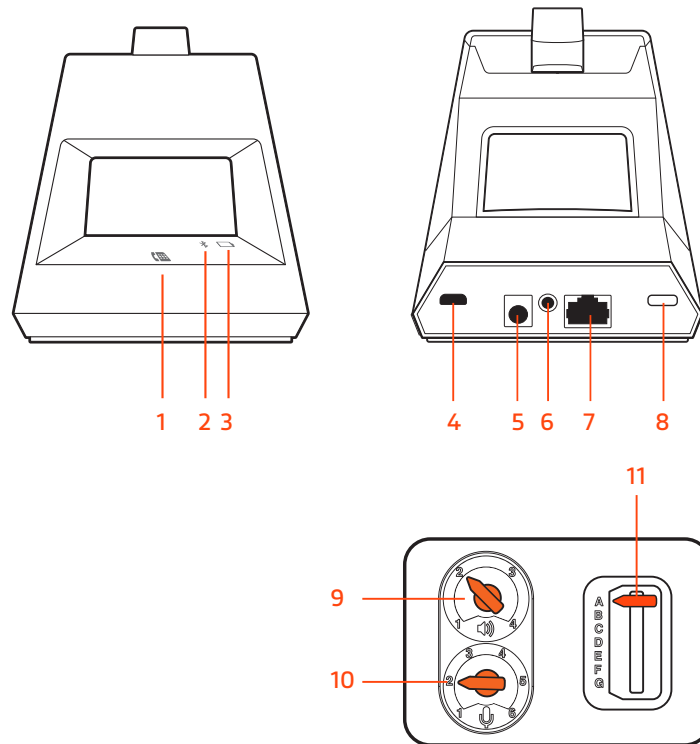

- 1 Desk phone LED
- 2 Bluetooth LED
- 3 Charging LED
- 4 USB port
- 5 Power jack
- 6 Handset lifter jack

- 7 Telephone interface cable jack
- 8 Headset Bluetooth pairing button
- 9 Desk phone listening volume
- 10 Desk phone speaking volume
- 11 Desk phone configuration switch

## Accessories

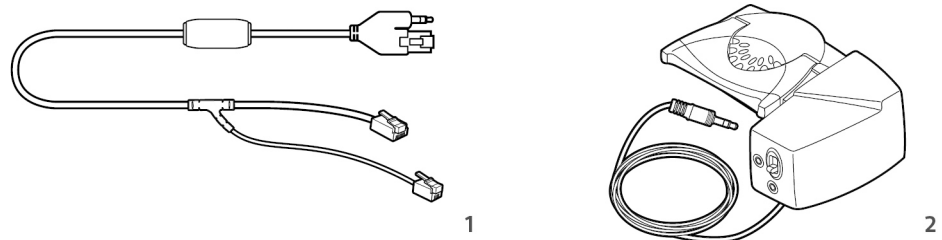

- 1 **Electronic hookswitch cable (EHS cable)** Electronically and automatically answers/ends a desk phone call. Enables remote call control with your headset.
- 2 **HL10 lifter** Automatically lifts handset and returns it to the cradle. Enables remote call control with your headset.

# Pair

## Pair headset to base

Your system has a base and compatible Bluetooth headset.

Your headset comes pre-paired to the base. To pair again:

- 1 Press the headset Call button until you hear "pairing" and the headset LEDs flash blue and red.
- 2 Put your base into pair mode by pressing and holding the Bluetooth pairing \* button on the back of your base for 2 seconds until the display panel's Bluetooth \* icon flashes blue and red.



Pairing is successful when you hear "pairing successful" and "base connected" and the display panel's Bluetooth \* icon turns solid blue.

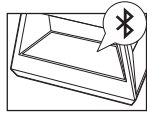

**NOTE** Your headset can pair with up to 8 devices but only maintain 2 connections simultaneously; this includes the base.

## Pair to mobile device

- 1 To put your headset in pair mode, press the Call button until you hear "pairing" and the headset LEDs flash blue and red.
- 2 Activate Bluetooth on your phone and set it to search for new devices.
  - iPhone Settings > Bluetooth > On\*
  - Android Settings > Bluetooth On > Scan for devices\*

**NOTE** \*Menus may vary by device.

- 3 Select "PLT V5200 Series."  
Once successfully paired, you hear "pairing successful" and the headset LEDs stop flashing.  
**NOTE** Your headset can pair with up to 8 devices but only maintain 2 connections simultaneously; this includes the base.

## Pair mode

With your headset powered on, press the Call button until you hear "pairing."



# Fit and charge

- Fit**
- 1 Slide headset over and behind your ear, then press gently toward your ear.  
**NOTE** Remove your eyeglasses before donning the headset for best fit.
  - 2 Rotate microphone boom until it is pointed toward your mouth.
  - 3 Mic boom moves up and down for a better fit.

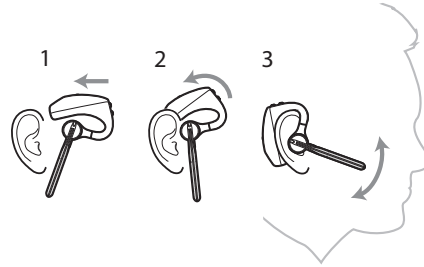

**Fit**  
Change the eartip for a better fit.

- 1 Push in eartip and rotate to the left to unlock it.

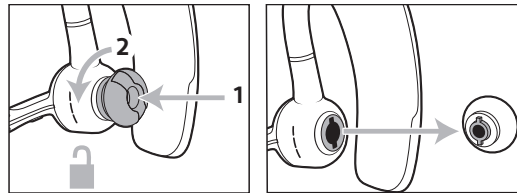

- 2 Align new eartip into slot; push, rotate to the right and lock into place.

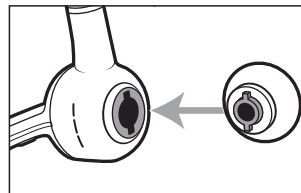
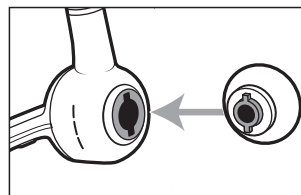

## Switch ears

To wear the headset on your other ear, rotate the boom upwards then twist it around so the eartip is on the other side before lowering the mic boom.

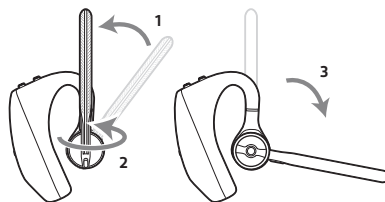

## Charge

Before first use, charge your headset for a minimum of 20 minutes by placing it in the cradle. The base display's battery  icon turns solid blue when charging and turns off when charge is complete. A full charge takes approximately 90 minutes.

**NOTE** You may also charge your headset using a micro-USB cable connected to a power source.

## Low battery warnings

Battery Level	Voice Prompt
30 minutes of talk time remaining	"Battery Low" repeats every 15 minutes
10 minutes of talk time remaining	"Recharge Headset" every 5 minutes

# Load software

Customize your device behavior through advanced settings and options with Poly Lens App. Some softphones require the installation of Poly software to enable device call control (answer/end and mute) functionality. Download: [poly.com/lens](https://poly.com/lens).

**NOTE** *Device settings are also available in Plantronics Hub App.*

## Update firmware

Keep your firmware up-to-date to improve performance and add new features to your Poly device.

Update your firmware using your computer with Poly Lens App. Download at [poly.com/lens](https://poly.com/lens).

While updating firmware:

- Do not use your Poly device until the update is complete.
- Disconnect your Poly device from paired devices such as phones, tablets and computers.
- Do not start a second update from a second device.
- Do not stream media.
- Do not answer or place a call.

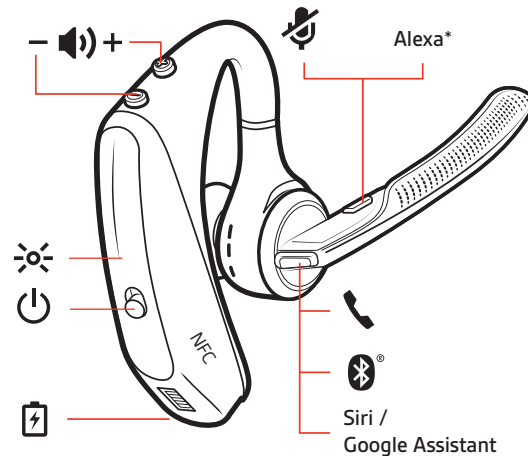

# The basics



## Power on/off

Slide the switch  to power on or off.

## Adjust volume

- **Headset volume** Fine-tune your headset volume by adjusting the headset's volume up (+) and down (-) controls.
- **Desk phone volume** When you are on a desk phone call and your voice is too quiet/loud, adjust the speaking  volume on the bottom of the base. If your caller's voice is too loud/quiet on a desk phone call, adjust the listening  volume.
- **Base ringtone volume** Adjust the base ringtone volume setting in Poly Lens Desktop App. This ringtone alerts you if you are not wearing your headset and a call comes in.

## Make, answer, end calls

### Make a call (deskphone)

- 1 Tap the headset call button. The desk phone  icon lights up on your base display. You should hear a dial tone in your headset.

**NOTE** Press your phone's Headset  button or manually remove the handset if you don't have an HL10 lifter or EHS cable.

**TIP** If you do not hear a dial tone, turn over the base and adjust the switch (A--G). "A" works for the majority of desk phones. "D" works for Cisco phones.

- 2 Dial from your desk phone.

### End/take a call

To answer or end a call, tap the headset Call button.

**NOTE** If you don't have an HL10 lifter or EHS cable, press your phone's Headset  button or remove the handset when answering a call and hang up when ending a call.

### Mute

During an active call, tap the Mute  button to mute or unmute your headset.

### Hold a call

To hold an active call or resume a held call:

- Double-press the headset Call .

**NOTE** 2 desk phone calls can be put on hold only from your desk phone.

### Switch between calls (flash)

To switch between calls:

- Double-press the headset Call \.

**NOTE** Switching 2 desk phone calls can only be done from your desk phone.

### Use sensors

Smart sensors respond when you put on or take off your headset. Customize in Poly Lens App. Below describes default settings.

With active sensors	putting on the headset will:	taking off the headset will:
Mobile/softphone call	answer the call	keep call in headset
Music/media	resume music/media (if playing previous to taking off)*	pause music/media (if playing)*
Lock headset	unlock the Call button	lock the Call button to avoid accidental calls

**NOTE** \*Functionality varies by application. May not function with web-based apps.

### Reset sensors

You may need to reset the sensors if they are not working as expected.

- Wearing the headset, tap the Call \ button to test sensors. A talk time voice alert means sensors are working. A tone or lack of voice prompts means sensors need to be reset.
- To reset the sensors, power on the headset, connect the headset to a USB cable and plug the cable into your computer's USB port or an AC wall adapter (not included). Then place the headset on a flat, non-metallic surface for more than 10 seconds.



### Disable sensors

- You can disable your headset smart sensors in Poly Lens App or by using a button press while your headset is idle. Simultaneously press and hold the Call \ and Mute \ buttons for 5 seconds. You hear "smart sensors off."

# More Features

## Play or pause audio

Tap the Call  button to pause or resume streaming audio.

**NOTE** *Functionality varies by application. May not function with web-based apps.*

## Voice assistant (smartphone feature)

**Siri, Google Assistant™, Cortana** Press and hold the Call button for 2 seconds to activate your smartphone's default voice assistant. Wait for the phone prompt to activate voice dialing, search, and other smartphone voice controls.

**ATTENTION** *Voice assistant is only active when your headset is out of base range and paired to a smartphone.*

## Enable and use Amazon Alexa (smartphone feature)

With Alexa enabled on your headset, you can ask for directions, call friends, access Alexa Skills and more.

**NOTE** *Amazon Alexa isn't available in all languages and countries.*

- 1 Enable Alexa
  - A Pair the headset to your mobile device
  - B Download or update your Plantronics Hub mobile app (software) if necessary.  
Download: [poly.com/software](https://poly.com/software)
  - C Launch Plantronics Hub app and ensure that your headset (firmware) is up-to-date
  - D From Plantronics Hub main menu, choose Apps > Amazon Alexa > Enable
  - E Launch the Amazon Alexa app and follow the instructions to set up your headset
- 2 Use Alexa
  - A To use Alexa, tap the Mute button (when not on a call) and ask a question. You hear a tone when Alexa is activated.

## Enable Tile

With the Tile app enabled on your mobile device, you can ring your lost headset or locate it on a map and ask the Tile community for help.

- 1 Pair the headset to your mobile device
- 2 Update your Plantronics Hub mobile app (software) if necessary
- 3 Launch Plantronics Hub app and ensure that your headset (firmware) is up-to-date
- 4 From Plantronics Hub main menu, choose Apps > Tile > Enable
- 5 Launch the Tile app and follow the instructions to connect your headset

# Troubleshooting

## Headset

I can't hear a dial tone in the headset.

- Make sure your headset is charged.
- Make sure your headset is paired to base. See [Pair headset to base](#).
- Adjust the configuration switch (A--F) on the bottom of the base until a dial tone is heard. The default **A** works for most phones.  
**ATTENTION** Use configuration **D** for Cisco phones. Cisco phones connected with EHS cable use configuration **A**.
- Make sure your desk phone is connected correctly to your base. See [Desk phone setup details](#).
- If your base is connected to your desk phone's dedicated headset port, press the desk phone's headset button to hear a dial tone.
- If your base is connected to your desk phone's dedicated headset port, press the desk phone's headset button and base's desk phone button to hear a dial tone.
- If your base is connected to your handset port, manually remove the handset to hear a dial tone (if you do not have an EHS cable or HL10 lifter).
- Make sure your HL10 lifter is lifting the handset high enough to operate the hookswitch; set to a higher setting if necessary.
- Adjust the headset's listening volume. See [Adjust volume](#).
- If the volume is still too low, adjust the desk phone listening volume on the base. See [Adjust volume](#).

Can I connect my headset to a mobile phone and the base at the same time?

Yes, your headset remembers up to 8 devices, but connect to up to 2 devices at a time. That includes your base.

I hear static.

- Make sure there is at least 12 inches between your base and your computer, and 6 inches between your base and your telephone. If adjusting the distance doesn't help, your headset is going out of range, move closer to the base. See [Position Your Base](#)

The sound is distorted.

- Lower the desk phone speaking volume and/or desk phone listening volume on the base. For most telephones the correct setting is position 2. See [Adjust volume](#).
- If your desk phone has a volume control, lower until the distortion disappears.
- If the distortion is still present, adjust the headset volume control to lower the headset speaker volume. See [Adjust volume](#).
- Make sure there is 12 inches between your base and your computer, and 6 inches between your base and your telephone. See [Position Your Base](#).

I hear echo in the headset.

- Lower the desk phone speaking volume and/or desk phone listening volume on the base. For most telephones the correct setting is position 2. See [Adjust volume](#).
- If the audio level is too low in this position, increase the headset volume. See [Adjust volume](#).
- If your speaking volume is too low for your listener in this position, adjust the position of the headset to make sure the microphone is as close as possible to your mouth.

---

People I talk to can hear a buzz in the background.

- Move the base further away from your phone. See [Position Your Base](#).
- If the base power supply is plugged into a power strip, plug it into the wall directly.

---

I can't activate Siri or Google Now on my headset.

- Your smartphone's default voice assistant is a mobile-only feature and is not active when your headset is in range of your base.
- Ensure that your headset is out of base range
  - Ensure that the headset is paired to your smartphone
  - See [Voice assistant](#)

---

## Desk phone

The handset lifter is installed but does not lift the handset.

- Be sure the handset lifter power cord is firmly pushed into the handset lifter jack on the base.
-



# Support

## NEED MORE HELP?

[poly.com/support](https://poly.com/support)

### **HP Inc.**

1501 Page Mill Road  
Palo Alto 94304, U.S.A.  
650-857-1501

### **HP Deutschland GmbH**

HP HQ-TRE  
71025 Boeblingen, Germany

### **HP Inc UK Ltd**

Regulatory Enquiries, Earley West  
300 Thames Valley Park Drive  
Reading, RG6 1PT  
United Kingdom

© 2023 Poly. Bluetooth is a registered trademark of Bluetooth SIG, Inc. All trademarks are the property of their respective owners. HP Inc.

Model ID: Headset: POTE16, base: CB5232 D.  
215649-06 05.23