



User Guide

© Copyright 2019 HP Development Company, L.P.

DisplayPort™, the DisplayPort™ logo, and VESA® are trademarks or registered trademarks owned by the Video Electronics Standards Association (VESA) in the United States and other countries. HDMI, the HDMI Logo and High-Definition Multimedia Interface are trademarks or registered trademarks of HDMI Licensing LLC. Intel® and Thunderbolt™ are trademarks of Intel Corporation or its subsidiaries in the U.S. and/or other countries. Windows is either a registered trademark or trademark of Microsoft Corporation in the United States and/or other countries.

The information contained herein is subject to change without notice. The only warranties for HP products and services are set forth in the express warranty statements accompanying such products and services. Nothing herein should be construed as constituting an additional warranty. HP shall not be liable for technical or editorial errors or omissions contained herein.

Product notice

This guide describes features that are common to most models. Some features may not be available on your product. To access the latest user guide, go to <http://www.hp.com/support>, and follow the instructions to find your product. Then select **User Guides**.





Second Edition: November 2019

First Edition: October 2019

Document Part Number: L81745-002

About this guide

This guide provides technical specifications and information about monitor features, setting up the monitor, and using the software. Depending on the model, your monitor may not have all the features included in this guide.

-
-  **WARNING!** Indicates a hazardous situation that, if not avoided, **could** result in serious injury or death.
 -  **CAUTION:** Indicates a hazardous situation that, if not avoided, **could** result in minor or moderate injury.
 -  **IMPORTANT:** Indicates information considered important but not hazard-related (for example, messages related to property damage). Warns the user that failure to follow a procedure exactly as described could result in loss of data or in damage to hardware or software. Also contains essential information to explain a concept or to complete a task.
 -  **NOTE:** Contains additional information to emphasize or supplement important points of the main text.
 -  **TIP:** Provides helpful hints for completing a task.
-

HDMI™
HIGH-DEFINITION MULTIMEDIA INTERFACE

This product incorporates HDMI technology.

Table of contents

1 Getting started	1
Important safety information	1
Product features and components	2
Features	2
Rear and side components	3
Front components	4
Setting up the monitor	6
Attaching the monitor stand	6
Mounting the monitor head	7
Removing the monitor stand	7
Attaching the monitor head to a mounting device	8
Connecting the cables	9
Connecting USB devices	12
Adjusting the monitor	12
Installing a security cable	14
Turning on the monitor	15
HP watermark and image retention policy	15
Docking an HP notebook or desktop computer	16
2 Using the monitor	17
Software and utilities	17
The Information file	17
The Image Color Matching file	17
Using the on-screen display (OSD) menu	18
Using the function buttons	19
Reassigning the function buttons	19
Changing the power mode setting	20
Power states	20
Using the camera	21
Using Windows Hello	22
Using Auto-Sleep Mode	23
Adjusting blue light output	23
DisplayPort multistreaming	24
Configuring an external monitor	25
Dock mode and Monitor mode	25
Dock mode	25

Monitor mode	25
Updating the docking monitor	26
Downloading the HP firmware installer	26
3 Support and troubleshooting	27
Solving common issues	27
Contacting support	28
Preparing to call technical support	29
Locating the serial number and product number	29
4 Maintaining the monitor	30
Maintenance guidelines	30
Cleaning the monitor	30
Shipping the monitor	30
Appendix A Technical specifications	31
60.5 cm (23.8 in) model specifications	31
68.6 cm (27 in) model specifications	32
Preset display resolutions	33
Entering user modes	34
Energy saver feature	35
Appendix B Accessibility	36
HP and accessibility	36
Finding the technology tools you need	36
The HP commitment	36
International Association of Accessibility Professionals (IAAP)	36
Finding the best assistive technology	37
Assessing your needs	37
Accessibility for HP products	37
Standards and legislation	38
Standards	38
Mandate 376 – EN 301 549	38
Web Content Accessibility Guidelines (WCAG)	38
Legislation and regulations	38
Useful accessibility resources and links	39
Organizations	39
Educational institutions	39
Other disability resources	39
HP links	40

Contacting support 40

1 Getting started

Important safety information

A power cord is included with the monitor. If another cord is used, use only a power source and connection appropriate for this monitor. For information about the correct power cord set to use with the monitor, see the *Product Notices* provided in your documentation kit.

 **WARNING!** To reduce the risk of electric shock or damage to the equipment:

- Plug the power cord into an AC outlet that is easily accessible at all times.
- If the power cord has a 3-pin attachment plug, plug the cord into a grounded (earthed) 3-pin outlet.
- Disconnect power from the computer by unplugging the power cord from the AC outlet. When unplugging the power cord from the AC outlet, grasp the cord by the plug.

For your safety, do not place anything on power cords or cables. Care should be taken to route all cords and cables connected to the monitor so that they cannot be stepped on, pulled, grabbed, or tripped over.

To reduce the risk of serious injury, read the *Safety & Comfort Guide*. It describes proper workstation setup and proper posture, health, and work habits for computer users. The *Safety & Comfort Guide* also provides important electrical and mechanical safety information. The *Safety & Comfort Guide* is available on the Web at <http://www.hp.com/ergo>.

 **IMPORTANT:** For the protection of the monitor, as well as the computer, connect all power cords for the computer and its peripheral devices (such as a monitor, printer, scanner) to some form of surge protection device such as a power strip or uninterruptible power supply (UPS). Not all power strips provide surge protection; the power strips must be specifically labeled as having this capability. Use a power strip whose manufacturer offers a damage replacement policy so you can replace the equipment if surge protection fails.

Use the appropriate and correctly sized furniture designed to properly support your monitor.

 **WARNING!** Monitors that are inappropriately situated on dressers, bookcases, shelves, desks, speakers, chests, or carts may fall over and cause personal injury.

 **NOTE:** This product is suitable for entertainment purposes. Consider placing the monitor in a controlled luminous environment to avoid interference from surrounding light and bright surfaces that may cause disturbing reflections from the screen.

Product features and components

Features

The monitor features include the following:

- 60.5 cm (23.8 in) diagonal viewable screen area with 1920 × 1080 resolution, plus full-screen support for lower resolutions
- 68.6 cm (27 in) diagonal viewable screen area with 2560 × 1440 resolution, plus full-screen support for lower resolutions
- USB Type-C port for docking an HP notebook or HP desktop mini
- Single power button on the monitor to turn the monitor and docked notebook on and off
- DisplayPort™ video output for daisy-chaining a second monitor
- Pull-up IR webcam and microphone for online collaboration
- RJ-45 (network) jack
- Nonglare panel with an LED backlight
- Wide viewing angle to allow viewing from a sitting or standing position, or when moving from side to side
- On-screen display (OSD) adjustments in several languages for easy setup and screen optimization
- Plug and Play capability, if supported by your operating system
- Tilt, swivel, and height adjustment capabilities
- Pivot capability to rotate the monitor head from landscape to portrait orientation
- Removable stand (optional) for flexible monitor head mounting solutions
- DisplayPort video input
- High-Definition Multimedia Interface (HDMI) video input
- Single USB-C input to host an HP notebook or HP desktop mini
- USB hub with one USB Type-C port and four USB Type-A ports that connect to USB devices
- Audio-out (headphone)/Audio-in (microphone) combo jack
- HP speaker bar support
- Up to 100 W power delivery through USB Type-C (5 A) cable
- Security cable slot on rear of monitor for optional security cable
- Windows Hello webcam
- HP Display Assistant software for adjusting monitor settings and enabling theft-deterrence features
- HDCP (High-bandwidth Digital Content Protection) used on all digital inputs
- Power Saver mode to meet requirements for reduced power consumption



NOTE: For safety and regulatory information, see the *Product Notices* provided in your documentation kit. To access the latest user guides or manuals for your product, go to <http://www.hp.com/support> and follow the instructions to find your product. Then select **User Guides**.

Rear and side components

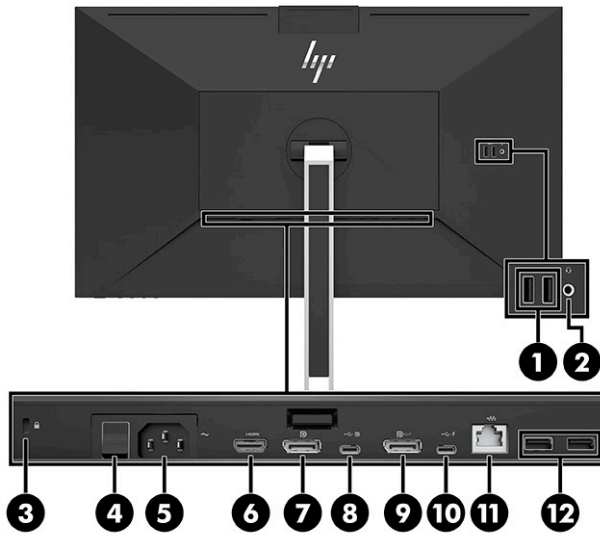

Table 1-1 Rear and side components and their descriptions

Component	Function
(1) USB SuperSpeed ports (2)	Connect USB cables to peripheral devices, such as a keyboard, mouse, or USB hard drive.
(2) Audio-out (headphone)/Audio-in (microphone) combo jack	Connects optional headphones, earbuds, a headset, or a television audio cable. WARNING! To reduce the risk of personal injury, reduce the volume before using headphones, earbuds, or a headset. For additional safety information, see the <i>Product Notices</i> provided in your documentation kit.
(3) Security cable slot	Connects an optional security cable.
(4) Master power switch	Turns on or off all power to the monitor. NOTE: To place the monitor in the lowest power state when it is not being used, turn the Master power switch to the Off position.
(5) Power connector	Connects a power cord.
(6) HDMI port	Connects the HDMI cable to a source device such as a computer or game console.
(7) DisplayPort connector	Connects the DisplayPort cable to a source device such as a computer or game console.
(8) USB Type-C port	Connects a USB Type-C cable to an HP notebook or desktop computer. Serves as a single connection for video, data, and power delivery (up to 100 W). NOTE: Your computer USB Type-C port must be able to support USB Type-C DP Alt Mode and data and power delivery.
(9) DisplayPort OUT connector	Connects a DisplayPort cable to a secondary monitor for daisy-chaining.
(10) USB Type-C downstream port	Connects a USB Type-C cable to a peripheral device, such as a keyboard, mouse, or USB hard drive.

Table 1-1 Rear and side components and their descriptions (continued)

Component	Function
(11) RJ-45 (network) jack	Connects a network cable.
(12) USB SuperSpeed ports (2)	Connect USB cables to peripheral devices, such as a keyboard, mouse, or USB hard drive.

NOTE: When HDMI or DP input is active, the monitor is in monitor mode. When USB Type-C Alt Mode is active, the monitor is in dock mode.

Front components

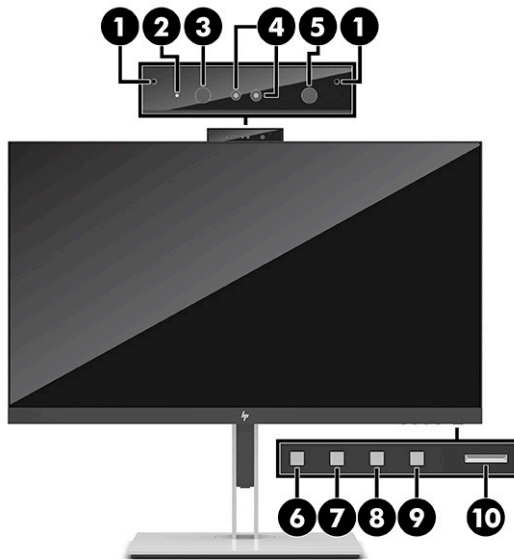
**Table 1-2 Front components and descriptions**

Component	Function
(1) Microphones	Allow you to participate in a video conference.
(2) Camera light	On: Camera is in use.
(3) RGB lens	Transmits your image in a video conference.
(4) IR lights	Not visible through IR transmissive ink.
(5) IR lens	Transmits your image in a video conference.
(6) Menu button	Press to open the OSD menu, select a menu item from the OSD, or close the OSD menu. An indicator is activated above the Menu button when the OSD menu is open.
(7–9) OSD buttons (assignable)	When the OSD menu is open, press the buttons to navigate through the menu. The function light icons indicate the default button functions. For a description of these functions, see Using the function buttons on page 19 .
(10) Power button (with power light)	Monitor mode: Turns the monitor on or off. Dock mode: <ol style="list-style-type: none"> When the computer is off, press the button to turn on the computer.

Table 1-2 Front components and descriptions (continued)

Component	Function
	<ol style="list-style-type: none">2. When the computer is on, press the button briefly to initiate sleep mode.3. When the computer is in sleep mode, press the button briefly to exit sleep (select products only).
	<p>When the computer is in hibernation mode, press the button briefly to exit hibernation.</p>
	<p>IMPORTANT: Pressing and holding down the power button results in the loss of unsaved information.</p>
	<p>If the computer has stopped responding and shutdown procedures are ineffective, press and hold the power button for at least 5 seconds to turn off the computer.</p>
	<p>NOTE: The power light varies depending on the mode. In Monitor mode, the light is white when the computer is on, and amber when the computer is in sleep mode. In Dock mode, the light is white when the computer is on, and blinking white when the monitor is in sleep mode.</p>



NOTE: To view an OSD menu simulator, visit the HP Customer Self Repair Services Media Library at <http://www.hp.com/go/sml>.

Setting up the monitor

Attaching the monitor stand

⚠ WARNING! To reduce the risk of serious injury, read the *Safety & Comfort Guide*. It describes proper workstation setup and proper posture, health, and work habits for computer users. The *Safety & Comfort Guide* also provides important electrical and mechanical safety information. The *Safety & Comfort Guide* is available on the Web at <http://www.hp.com/ergo>.

📄 IMPORTANT: To prevent damage to the monitor, do not touch the surface of the LCD panel. Pressure on the panel may cause nonuniformity of color or disorientation of the liquid crystals. If this occurs, the screen will not recover to its normal condition.

IMPORTANT: To prevent the screen from getting scratched, defaced, or broken and to prevent damage to the control buttons, position the monitor facedown on a flat surface covered with protective sheet foam or a nonabrasive cloth.

1. Position the monitor facedown on a flat surface covered by a soft clean cloth.
2. Slide the top of the mounting plate on the stand under the upper lip of the recess in the back of the monitor head (1).
3. Lower the bottom of the stand's mounting plate into the recess (2) until it snaps into place. The latch on the bottom of the mounting plate pops up when the stand is locked in place.

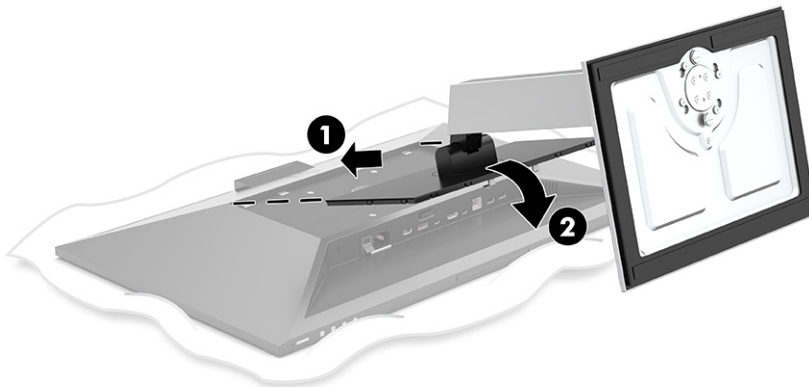

Mounting the monitor head

The monitor head can be attached to a wall, swing arm, or other mounting fixture.

IMPORTANT: This monitor supports the VESA® industry-standard 100 mm mounting holes. To attach a third-party mounting solution to the monitor, use four 4 mm, 0.7 pitch, 10 mm–long screws. Longer screws might damage the monitor. Verify that the manufacturer’s mounting solution is compliant with the VESA standard and is rated to support the weight of the monitor head. For best performance, use the power and video cables provided with the monitor.

NOTE: This apparatus is intended to be supported by a UL-listed or CSA-listed wall-mount bracket.

Removing the monitor stand

IMPORTANT: Before disassembling the monitor, be sure that the monitor is turned off and all cables are disconnected.

1. Disconnect and remove all cables from the monitor.
2. Position the monitor facedown on a flat surface covered by protective sheet made of foam or a clean, dry cloth.
3. Push up on the latch near the bottom center of the stand’s mounting plate (1).
4. Swing the bottom of the stand up until the mounting plate clears the recess in the monitor head (2).
5. Slide the stand out of the recess (3).

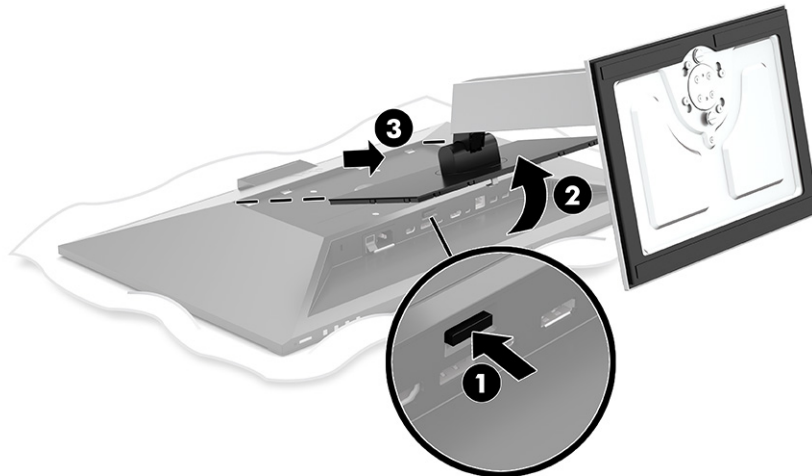

Attaching the monitor head to a mounting device

1. Remove the four screws from the VESA holes located on the rear of the monitor head.

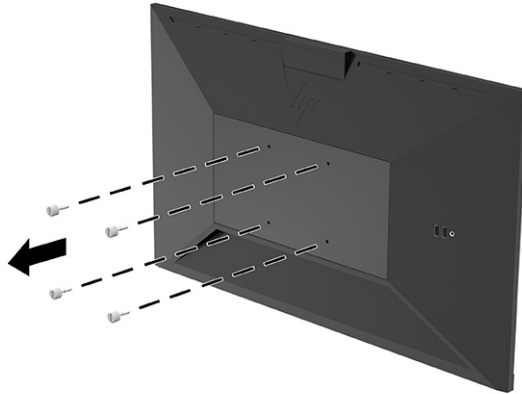

2. To attach the monitor head to a swing arm or other mounting device, insert four mounting screws through the holes on the mounting device and into the VESA screw holes on the back of the monitor head.

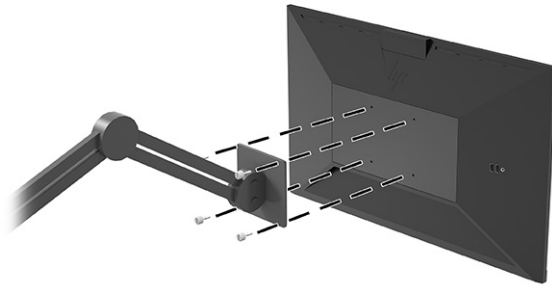

Connecting the cables

 **NOTE:** The monitor ships with select cables. Not all cables shown in this section are included with the monitor.

1. Place the monitor in a convenient, well-ventilated location near the computer.
2. Before connecting the cables, route the cables through the cable routing hole in the center of the stand.

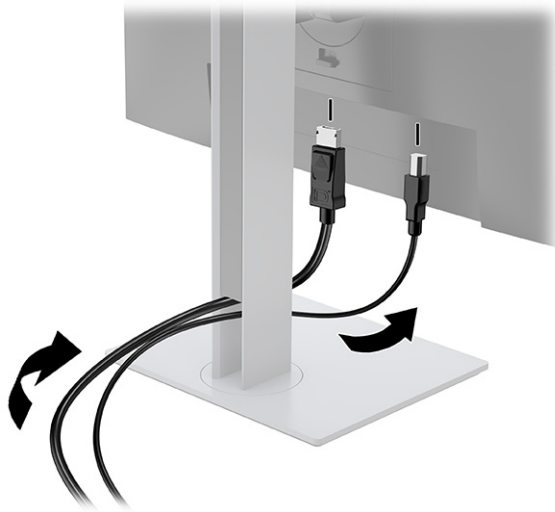

3. Connect a video cable.

 **NOTE:** The monitor automatically determines which inputs have valid video signals. Select the inputs by pressing the **Menu** button to access the on-screen display (OSD) menu and then selecting **Input**.

- Connect one end of a USB Type-C cable to the USB Type-C port on the rear of the monitor and the other end to the USB Type-C port on the source device. (Use only the HP-approved USB Type-C cable provided with the monitor.)

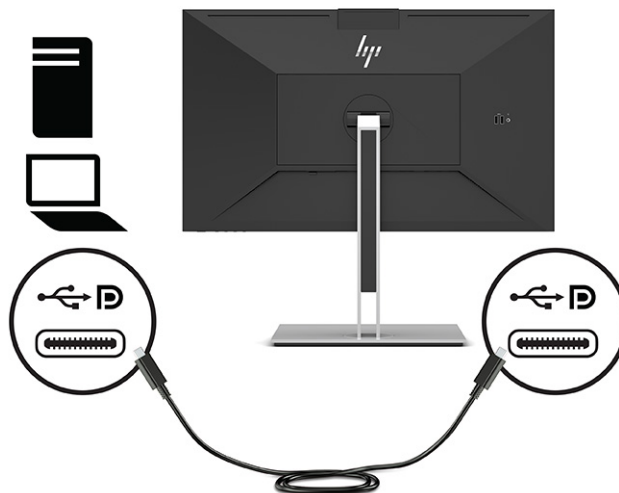

 **NOTE:** The monitor's USB Type-C port provides network, data, video, and power delivery (up to 100 W).

The host device must be able to support DisplayPort Alt Mode (video, charging and USB 3.1) over the USB Type-C connector. The host device must also be compatible with USB Type-C, Thunderbolt-enabled ports.

- Connect one end of a DisplayPort cable to the DisplayPort connector on the rear of the monitor and the other end to the DisplayPort connector on the source device.

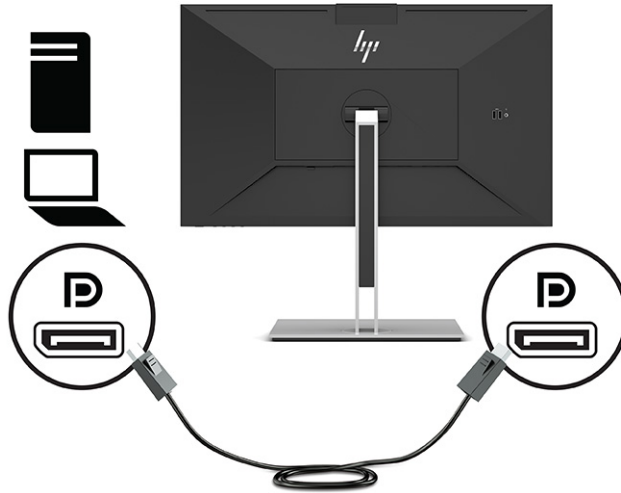

- Connect one end of an HDMI cable to the HDMI port on the rear of the monitor and the other end to the HDMI port on the source device.

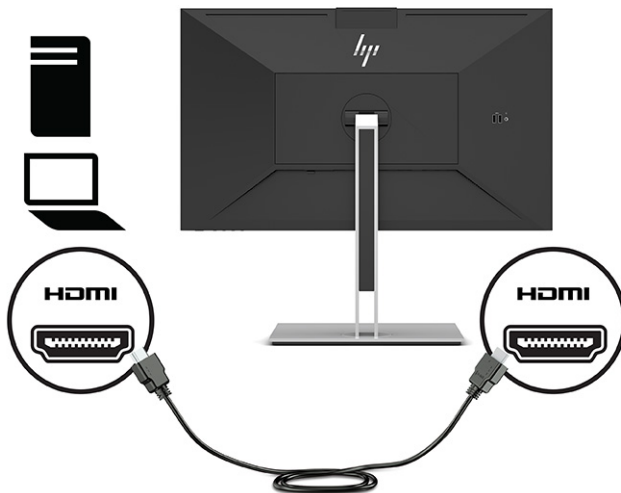

4. Connect one end of a network cable to the network jack on the monitor and the other end to a network wall jack or router.

 **NOTE:** To enable the network function, make sure the USB upstream port is connected.

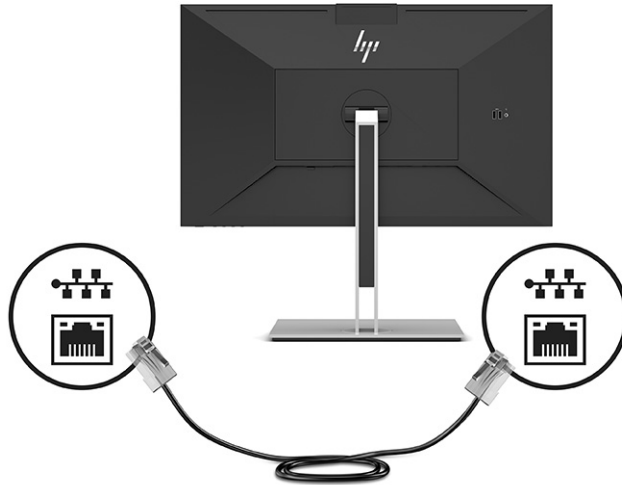

5. Connect one end of the power cord to a grounded AC outlet and the other end to the power connector on the monitor.

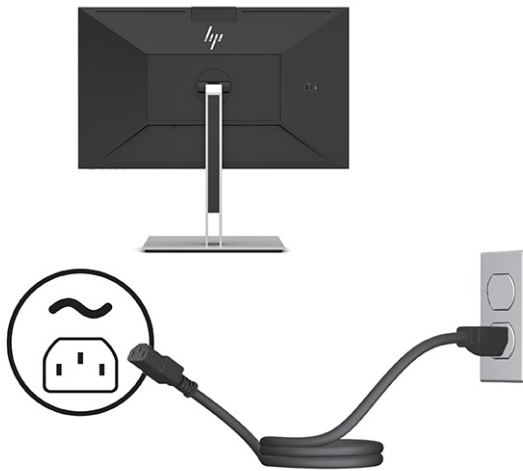

 **WARNING!** To reduce the risk of electric shock or damage to the equipment:

Do not disable the power cord grounding plug. The grounding plug is an important safety feature.

Plug the power cord into a grounded (earthed) AC outlet that is easily accessible at all times.

Disconnect power from the equipment by unplugging the power cord from the AC outlet.

For your safety, do not place anything on power cords or cables. Arrange them so that no one may accidentally step on or trip over them. Do not pull on a cord or cable. When unplugging the power cord from the AC outlet, grasp the cord by the plug.

Connecting USB devices

There are five USB ports on the monitor to connect to a device (downstream): two USB Type-A and one USB Type-C on the rear, and two USB Type-A on the side.

 **NOTE:** You must connect the USB Type-C upstream cable from the source device (computer) to the rear of the monitor to enable the USB Type-A and USB Type-C downstream ports on the monitor. USB downstream ports can connect keyboards, webcams, phones, external hard drives, and practically anything that is USB-connected and can accept 5 V.

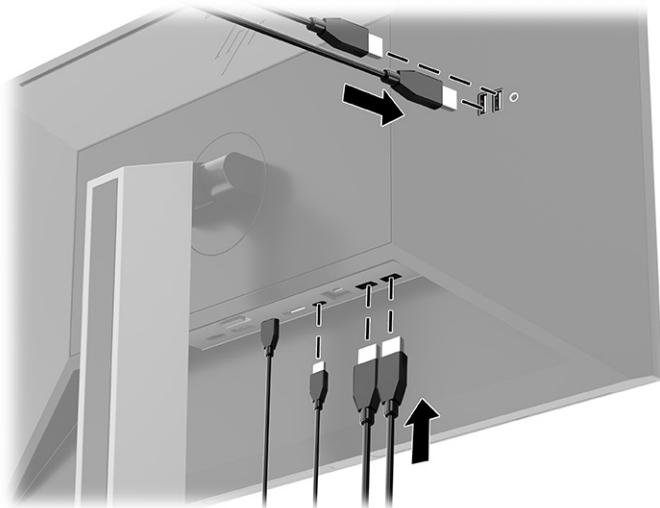

Adjusting the monitor

 **WARNING!** To reduce the risk of serious injury, read the *Safety & Comfort Guide*. It describes proper workstation setup, and proper posture, health, and work habits for computer users. The *Safety & Comfort Guide* also provides important electrical and mechanical safety information. The *Safety & Comfort Guide* is available on the Web at <http://www.hp.com/ergo>.

1. Tilt the monitor head forward or backward to set it to a comfortable eye level.

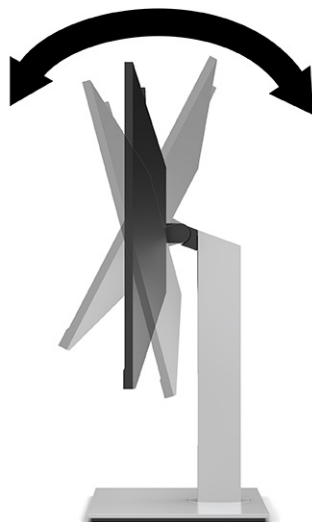

2. Swivel the monitor head to the left or right for the best viewing angle.

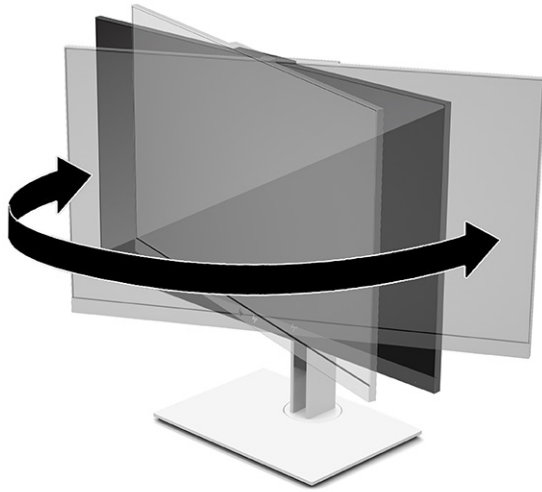

3. Adjust the monitor's height to a comfortable position for your individual workstation. The monitor's top bezel edge should not exceed a height that is parallel to your eye height. A monitor that is positioned low and reclined may be more comfortable for users with corrective lenses. Reposition your monitor as you adjust your working posture throughout the work day.

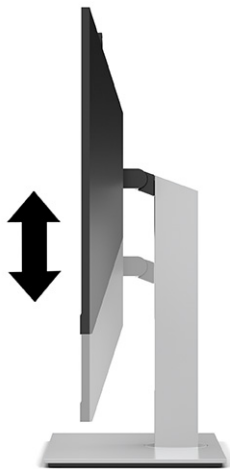

4. You can pivot the monitor head from landscape to portrait orientation viewing to adapt to your application.
 - a. Adjust the monitor to full height position and tilt the monitor head back to full tilt position (1).
 - b. Pivot the monitor head clockwise or counter-clockwise 90° from landscape to portrait orientation (2).

 **IMPORTANT:** If the monitor is not in full-height and full-tilt position when pivoting, the bottom corner of the monitor head will come in contact with the base and potentially cause damage to the monitor.

If you are adding an optional speaker bar to the monitor, install it after pivoting the monitor. The speaker bar will come in contact with the base when pivoting and potentially cause damage to the monitor or speaker bar.

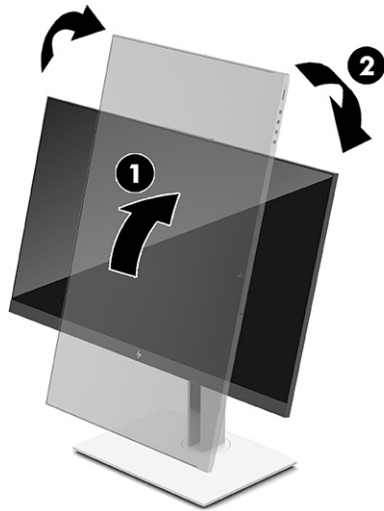

 **NOTE:** Use the operating system's display settings to rotate the image on the screen from portrait to landscape. To rotate the OSD from portrait to landscape, open the OSD menu and select **Menu**, and then select **Menu Position**.

Installing a security cable

You can secure the monitor to a fixed object with an optional security cable available from HP. Use the key provided to attach and remove the lock.

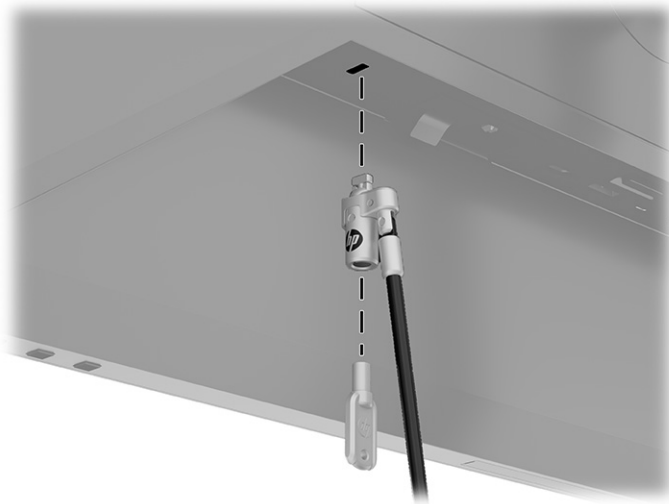

Turning on the monitor

1. Press the power button on the computer to turn it on.
2. Press the power button on the bottom of the monitor to turn it on.



IMPORTANT: Burn-in image damage may occur on monitors that display the same static image on the screen for 12 or more consecutive hours of nonuse. To avoid burn-in image damage on the monitor screen, you should always activate a screen saver application or turn off the monitor when it is not in use for a prolonged period of time. Image retention is a condition that may occur on all LCD screens. Burn-in damage on the monitor is not covered under the HP warranty.

NOTE: Pressing the power button on the monitor also turns a docked notebook on and off.

When the monitor is first turned on, a monitor status message is displayed for 5 seconds. The message shows which input is the current active signal, the status of the auto-switch source setting (On or Off; default setting is On), the current preset display resolution, and the recommended preset display resolution.

The monitor automatically scans the signal inputs for an active input and uses that input for the display.

HP watermark and image retention policy

The IPS monitor models are designed with IPS (In-Plane Switching) display technology which provides ultra-wide viewing angles and advanced image quality. IPS monitors are suitable for a wide variety of advanced image quality applications. This panel technology, however, is not suitable for applications that exhibit static, stationary, or fixed images for long periods of time without the use of screen savers. These types of applications may include camera surveillance, video games, marketing logos, and templates that are displayed on the screen for a prolonged period of time. Static images may cause image retention damage that could look like stains or watermarks on the monitor's screen.

A burned-in image on the monitor is not covered under the HP warranty. To avoid image retention damage, either turn off the monitor when it is not in use or use the power management setting, if supported on your system, to turn off the monitor when the system is idle.

Docking an HP notebook or desktop computer

You can dock the computer to the monitor with a single USB Type-C connection. The USB Type-C port provides network, data, video, and power delivery when docking the computer. Make sure the network cable is connected from the network source jack to the monitor's network jack for a network connection through USB Type-C.

 **NOTE:** The host computer must be able to support DisplayPort Alt Mode (video, charging, and USB 3.1) over the USB Type-C connector and must also be compatible with USB Type-C, Thunderbolt-enabled ports.

Connecting two host computers to the docking monitor may result in system shutdown, loss of power, and the need to turn off and restart the monitor.

For optimal performance, use the docking monitor with a computer running a Windows 10 version 1809 or higher operating system.

To dock the computer, connect one end of a USB Type-C cable to the USB Type-C port on the rear of the monitor and the other end to the USB Type-C port on the computer. This USB Type-C cable provides single-cable connectivity for high-speed data, audio and video, and power delivery.

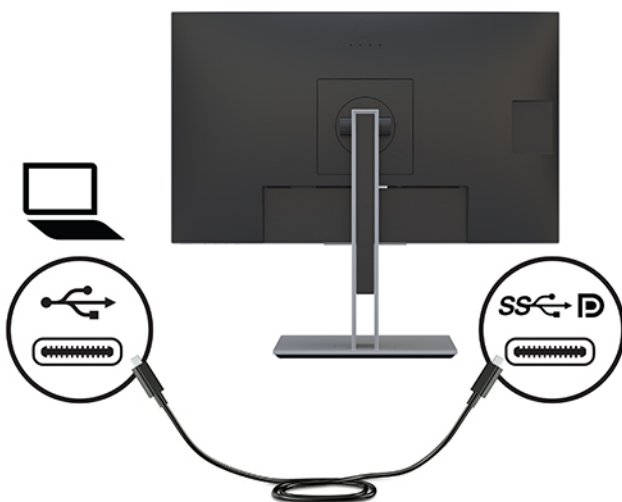

 **NOTE:** The monitor delivers up to 100 W of power over the USB Type-C connection.

 **NOTE:** When you set **Auto-Switch Input** to **On** in the OSD, the monitor automatically switches to **USB-C Video** input if USB-C DP Alt Mode is connected or active.

2 Using the monitor

Software and utilities

You can download and install the following files to your computer from <http://www.hp.com/support>:

- INF (Information) file
- ICM (Image Color Matching) files
- HP Display Assistant software

The Information file

The INF file defines monitor resources used by Windows® operating systems to ensure monitor compatibility with the computer's graphics adapter.

This monitor is Windows Plug and Play-compatible and the monitor will work correctly without installing the INF file. Monitor Plug and Play compatibility requires that the computer's graphics card is VESA DDC2-compliant and that the monitor connects directly to the graphics card. Plug and Play does not work through separate BNC-type connectors or through distribution buffers, boxes, or both.

The Image Color Matching file

The ICM files are data files that are used in conjunction with graphics programs to provide consistent color matching from monitor screen to printer, or from scanner to monitor screen. These files are activated from within graphics programs that support this feature.



NOTE: The ICM color profile is written in accordance with the International Color Consortium (ICC) Profile Format specification.

Using the on-screen display (OSD) menu

Use the on-screen display (OSD) menu to adjust the screen image based on your viewing preferences. You can access and make adjustments in the OSD using the buttons at the bottom of the monitor's front bezel.

To access the OSD menu and make adjustments:

1. If the monitor is not already on, press the power button to turn on the monitor.
2. Press the **Menu** button to open the OSD.
3. Use the three function buttons to navigate, select, and adjust the menu choices. The on-screen button labels vary depending on which menu or submenu is active.

The following table lists possible menu selections in the OSD main menu.

Table 2-1 OSD menu options and descriptions

Main menu	Description
Brightness	Adjusts the brightness and contrast levels of the screen.
Color	Selects and adjusts the screen color.
Image	Adjusts the screen image.
Input	Selects the video input signal.
Power	Adjusts the power settings.
Menu	Adjusts the on-screen display (OSD) and function button controls.
Management	Adjusts the DDC/CI settings, selects the language in which the OSD menu is displayed (the factory default is English), and returns all OSD menu settings to the factory default settings.
Information	Selects and displays important information about the monitor.
Exit	Exits the OSD menu screen.

Using the function buttons

Pressing one of the four OSD buttons activates the buttons and displays icons above the buttons. The following illustration shows the default button icons and functions.

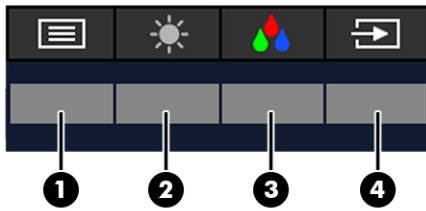

Table 2-2 Button names and descriptions

Button	Function
(1) Menu button	Opens the OSD main menu, selects a menu item from the OSD, or closes the OSD menu.
(2) Brightness button Assignable function button	Adjusts the brightness and contrast levels of the screen.
(3) Color button Assignable function button	Selects and adjusts the screen color.
(4) Next Active Input button Assignable function button	Switches the monitor's input source to the next active input.

Reassigning the function buttons

You can change the assignable function buttons from their default values so that when the buttons are activated, you can quickly access commonly used menu items. You cannot reassign the [Menu](#) button.

To reassign the function buttons:

1. Press the [Menu](#) button to open the OSD menu.
2. Select **Menu**, select **Assign Buttons**, and then select one of the available options for the button that you want to assign.

Changing the power mode setting

To comply with international power standards, when the monitor is in sleep mode, the monitor's default setting is Power Saver mode. If your monitor supports Performance mode, then to keep the USB ports enabled when the monitor is in sleep mode, change the power mode setting from **Power Saver** mode to **Performance** mode. Enabling Performance mode increases power consumption.

To change the power mode setting:

1. Press the **Menu** button to open the OSD menu.
2. Select **Power**, select **Power Mode**, and then select **Performance**.
3. Select **Save** and close the OSD.

 **NOTE:** When the power mode is set to Performance, the USB hub, USB ports, and USB Type-C video input remain on, even when the monitor is in sleep mode.

 **NOTE:** When the monitor detects a USB Type-C cable connection, the monitor automatically switches the **Power Mode** to **Performance** and remains there until you manually switch back to **Power Saver** mode.

The monitor remains in **Performance** mode after a factory reset is performed and Alt mode is detected as active.

Power states

The monitor power behavior is based on host computer power settings (sleep, hibernation, shut down, and restart). If the computer initiates sleep or hibernation, the monitor turns off. When the computer exits sleep or hibernation, the connected monitor returns to the previous monitor settings. If you restart or shut down the computer and then turn it back on, the connected monitor returns to the previous monitor settings.

Monitor power light status indicator:

- On: White
- Sleep: Amber

Monitor connected to computer power light status indicator:

- Monitor and computer On: White
- Monitor and computer in sleep state: White (blinking)

Using the camera

Gently pull up the camera to unlock it by using the grips on the back of the camera.

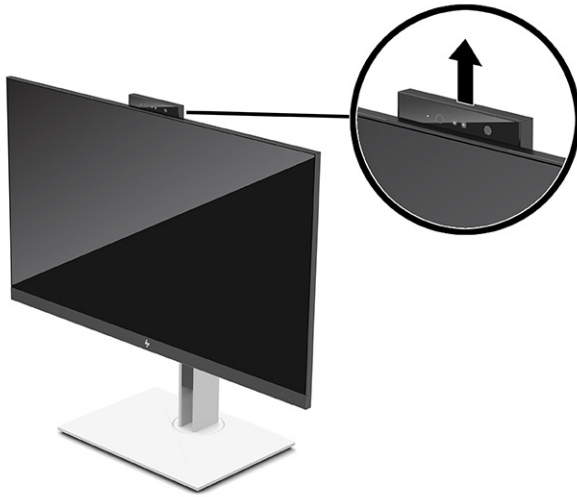

NOTE: If a camera firmware update is required, the camera must be in the unlocked position while updating the firmware.

You can use the camera on the monitor to:

- Sign in to Windows by using Windows Hello facial recognition
- Maintain conversation security
- Video conferencing

NOTE: For video conferencing, connect the computer to the monitor and then select **Display IR Camera** from the video conferencing interface.

When the camera is not in use, you can close the camera by pressing down on it until it clicks into the closed position.

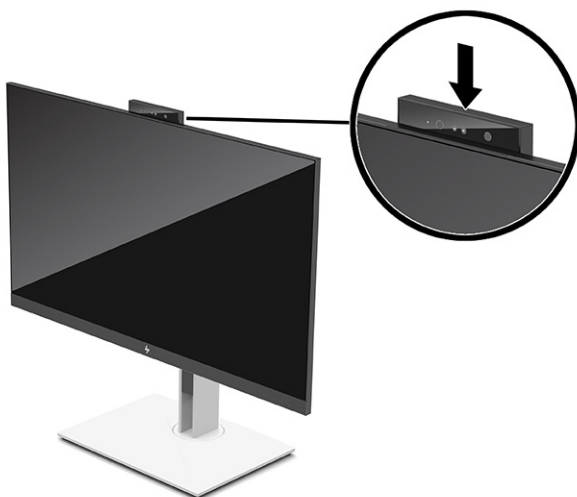

NOTE: When the camera is closed, the microphone on the camera is disabled.

Using Windows Hello

You can use Windows Hello to sign in to Windows devices using either your computer's IR camera or your monitor's IR camera. Your computer's IR camera is set as the default for Windows Hello facial recognition. To set up Windows Hello using the computer's IR camera:

1. Select the **Start** button, select **Settings**, select **Accounts**, and then select **Sign-in options**.
2. Under **Windows Hello**, select **Set up** under **Face Recognition**.
3. Under **Welcome to Windows Hello**, select **Get Started**, and then follow the on-screen instructions to enroll your facial ID and set up a PIN.

You can now use the IR camera on the computer to log in when using Windows Hello.

If you want to use your monitor's IR camera to sign in to Windows devices:

1. If your computer has an IR camera, disable the computer's IR camera from Device Manager.
2. Restart the computer.
3. Select the **Start** button, select **Settings**, select **Accounts**, and then select **Sign-in options**.
4. Under **Windows Hello**, select **Set up** under **Face Recognition**.

You can now use the IR camera on the monitor to log in when using Windows Hello.



NOTE: Windows Hello is only supported on the Windows 10 operating system.

Using Auto-Sleep Mode

The monitor supports an OSD menu option called Auto-Sleep Mode that allows you to enable or disable a reduced power state for the monitor. When Auto-Sleep Mode is enabled (enabled by default), the monitor enters a reduced power state when the computer signals low power mode (absence of either horizontal or vertical sync signal).

Upon entering this reduced power state (sleep mode), the monitor screen is blanked, the backlight turns off, and the power light turns amber. The monitor draws less than 0.5 W of power when in this reduced power state. The monitor wakes from sleep mode when the computer sends an active signal to the monitor (for example, if you activate the mouse or keyboard).



NOTE: See [Changing the power mode setting on page 20](#) to enable the USB ports while in sleep mode.

To disable Auto-Sleep Mode in the OSD:

1. Press the **Menu** button to open the OSD.
2. In the OSD menu, select **Power**.
3. Select **Auto-Sleep Mode**, and then select **Off**.

Adjusting blue light output

Decreasing the blue light emitted by the monitor reduces the blue light exposure to your eyes. This monitor allows you to select a setting to reduce blue light output and create a more relaxing and less stimulating image while you read content on the screen.

To adjust the blue light output from the monitor:

1. Press one of the OSD buttons to activate the buttons, and then press the **Menu** button to open the OSD.
2. Select **Color**, and then select a setting:
 - **Low Blue Light** (TUV certified): Reduces blue light for improved eye comfort.
 - **Night**: Adjusts to the lowest blue light and reduces the impact on sleep.
 - **Reading**: Optimizes blue light and brightness for indoor viewing.
3. Select **Save and Return** to save your setting and close the menu. Select **Cancel** if you don't want to save the setting.
4. In the Main menu, select **Exit**.

DisplayPort multistreaming

If you are using USB Type-C or DisplayPort as the primary video input source, you can multistream to other DisplayPort monitors connected in a daisy chain configuration.

The number of monitors you can connect through DisplayPort multistreaming depends on a number of factors, including the resolutions and scan rates used for each monitor and the capabilities of your GPU or embedded graphics system. Check the manual that came with your graphics card for further information about its capabilities.

 **NOTE:** For optimal daisy chain performance on the 60.5 cm (23.8 in) monitor, it is recommended that you use an FHD monitor as the second monitor.

For optimal daisy chain performance on the 68.6 cm (27 in) monitor, it is recommended that you use a QHD 60 Hz or FHD 60 Hz monitor as the second monitor. It is also recommended that you adjust the settings in the OSD. Select **Input**, and then select **USB-C Video**. Also select **USB-C Configuration**, and then select **USB 2.0**. Disconnect and connect the USB Type-C cable to complete the change.

To multistream:

1. Connect a cable between the USB Type-C port on the computer and the USB Type-C with DisplayPort upstream connector on the monitor, or connect a cable between the DisplayPort connector on the computer and the DisplayPort connector on the monitor.
2. Add a second monitor by connecting a cable between the DisplayPort out port on the primary monitor and the DisplayPort in port on a secondary monitor.

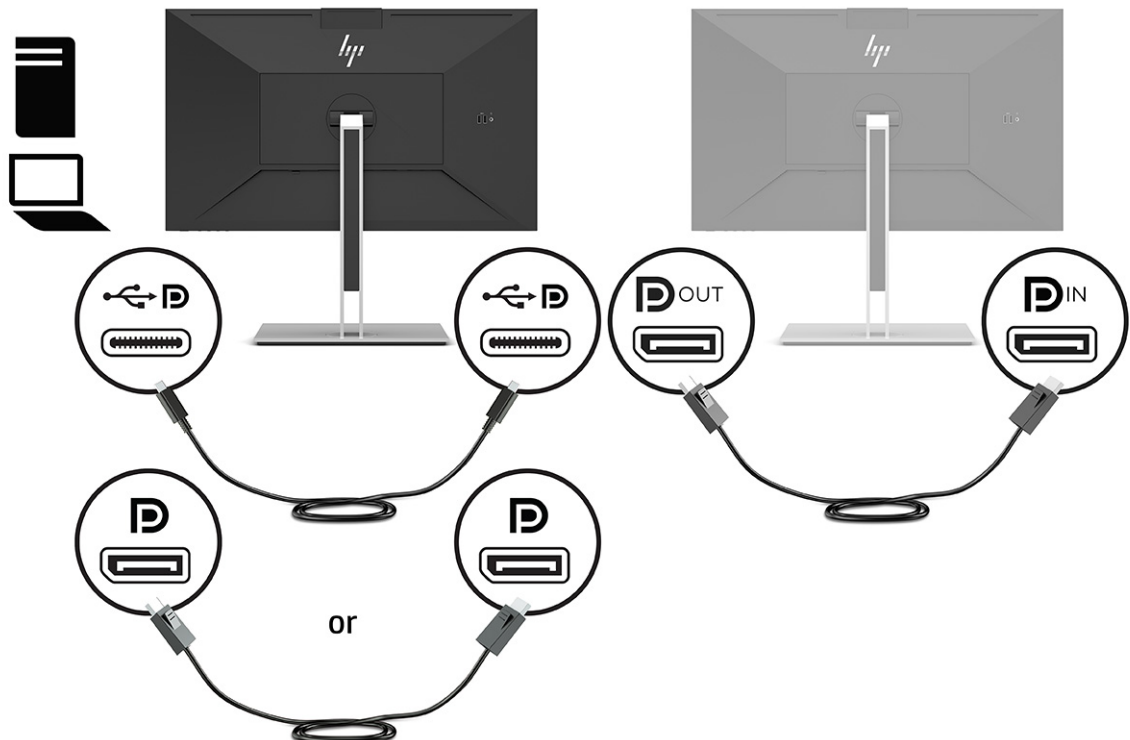

3. Set a connected monitor to display the same image as the primary monitor or a different image.
4. If you want different information on each screen, be sure that all upstream monitors are configured to DisplayPort 1.2 mode.

Configuring an external monitor

Use Windows to configure the display of a monitor attached to the docking station.

1. Type `control panel` in the taskbar search box, and then select **Control Panel**. Select **Appearance and Personalization**.
2. To set the external monitor as the primary monitor, select **Second screen only**.
or
To set the external monitor as an extension of the primary monitor, select **Extend**.
or
To set the external monitor as a copy of the primary monitor, select **Duplicate**.



NOTE: You can also access the display settings by pressing the [Windows](#) key + `p`.

Dock mode and Monitor mode

Dock mode

When a USB Type-C cable is connected to the computer and Alt mode is detected, the monitor switches to the Dock mode and the following features are activated.

- **PXE boot**
- **MAC Address Pass Through**

TIP: Your computer might support MAC Address Pass Through from the on, off, sleep, or hibernation states, or only when the computer is on or in the sleep state.

The MAC Address Pass Through is supported for UEFI PXE boot.

- **Wake on LAN (WOL)**

TIP: Your computer might support WOL from the off, sleep, or hibernation states, or only when the computer is on or in the sleep state.

WLAN-LAN switching is supported only on select computers running the Windows 10 operating system. Connect the docking station to the computer. Connect one end of the network cable to the RJ-45 (network) jack on the docking monitor and connect the other end to an RJ-45 wall jack or router.

- **Single power on**

Pressing the monitor power button can also turn on power to the computer.

Monitor mode

When an HDMI or DisplayPort cable is connected to the computer, the monitor is in Monitor mode. The default power mode is Power Saver.

The monitor will also be in Monitor mode when the USB Type-C cable is connected to a non-HP USB-C notebook.

Updating the docking monitor

Downloading the HP firmware installer

1. Go to <http://www.hp.com/support>.
2. Select **Get software and drivers**, and follow the on-screen instructions to find your docking monitor.
3. Follow the on-screen instructions to select and download the HP firmware installer.
4. Complete the installation wizard.
5. Choose to restart now or later. The docking station might not work until the next restart. If you choose to restart the computer, remove any removable media from the computer and then select **Finish**.

To update the docking monitor firmware while connected to your computer:

1. Open Windows Explorer and navigate to where you saved the HP firmware installer.
2. Double-click **HPFirmwareInstaller.exe**.
3. Verify that updates are available, and then select which updates to install.

 **TIP:** You must be connected to the Internet for new updates to download to the HP firmware installer.

4. Select one of the following:

- **Update now:** Installs the update immediately.

 **NOTE:** Do not disconnect your computer from the docking monitor during an update. You might see your monitor flicker and hear some audio clicks, your Internet connection might be intermittent, and your mouse and keyboard could become unresponsive until installation is complete.

- **Update on dock disconnect:** Installs the update after you disconnect your computer from the docking monitor.

 **NOTE:** Do not connect your computer to the docking monitor during an update. The dock power light might blink while the update is being installed.

5. Select **Install**.

3 Support and troubleshooting

Solving common issues

The following table lists possible issues, the possible cause of each issue, and the recommended solutions.

Table 3-1 Common issues and solutions

Issue	Possible cause	Solution
Screen is blank or video is flashing.	Power cord is disconnected.	Connect the monitor power cord.
	Monitor is off.	Press the monitor power button.
	Video cable is improperly connected.	Connect the video cable properly. For more information, see Connecting the cables on page 9 .
	System is in Auto-Sleep Mode.	Press any key on the keyboard or move the mouse to inactivate the screen blanking utility.
Image appears too dark.	Brightness setting is too low.	Open the OSD menu and select Brightness to adjust the brightness scale as needed.
"Input Signal Not Found" is displayed on the screen.	Monitor video cable is disconnected.	Connect the appropriate video signal cable between the computer and monitor. Be sure that the computer power is off when connecting the video cable.
"Input Signal Out of Range" is displayed on the screen.	Video resolution and/or refresh rate are set higher than the monitor supports.	Change the settings to a supported setting. See Preset display resolutions on page 33 for more information.
The monitor does not enter into a low-power sleep state.	The monitor's power saving control is disabled.	Open the OSD menu and select Power , select Auto-Sleep Mode , and then set auto-sleep to On .
The monitor's camera does not work when you use Windows Hello.	The monitor camera is not set as the default.	Configure the monitor camera. For more information, see Using the camera on page 21 .
The power light is off.	The docking monitor is not connected to AC power.	Connect the power cord to the docking station and to an AC outlet.
The ports or jacks on the docking station do not work.	The docking monitor is not connected to AC power.	Connect the power cord to the docking station and to an AC outlet.
	The docking monitor is not connected to the computer correctly.	Disconnect the USB cable from the computer, and then reconnect it.
Disconnect the USB cable from the computer, and then reconnect it.	The USB device attached to the port is not compliant with the docking monitor power specifications and is using too much power.	Disconnect the device that disabled the port.
		Disconnect the power cord from the docking monitor, and then reconnect it.

Table 3-1 Common issues and solutions (continued)

Issue	Possible cause	Solution
		Disconnect the docking monitor from the computer, and then reconnect it.
	The docking monitor is set to Power Saver mode.	Set Power Mode to Performance in the OSD.
Data transfer speeds through USB or Ethernet are slow.	Multiple high-resolution monitors are connected to the docking station.	Disable high-resolution mode or disconnect a monitor.
Headphones or other audio devices connected to the docking station do not produce sound.	An audio device is connected to the headphone jack on the docking monitor, but the docking station is not the default audio device.	Set the docking monitor as the default audio device in the computer settings, or connect the audio device to the computer.
A microphone connected to the docking station does not work.	A microphone is connected to the docking monitor, but the docking station is not the default audio device.	Set the docking station as the default audio device in the computer settings, or connect the microphone to the computer.
The graphics application does not detect the external monitor.	Some graphics applications do not detect external monitors connected to the docking station.	Configure the external monitor.
The external monitor cannot be set as the primary monitor when using some Intel graphics applications.	Older Intel graphics applications do not support setting the external monitor as the primary monitor.	Download the latest Intel drivers from http://www.hp.com/support .
Resolution does not look correct for the extended monitor.	The extended monitor's resolution is incorrect.	Change the USB-C configuration in the OSD. Disconnect the USB Type-C cable and reconnect it to the computer.

Contacting support

To resolve a hardware or software problem, go to <http://www.hp.com/support>. Use this site to get more information about your product, including links to discussion forums and instructions on troubleshooting. You can also find information about how to contact HP and open a support case.



NOTE: Contact customer support to replace the power cord, the AC adapter (select products only), or any other cables that shipped with your monitor.

Preparing to call technical support

If you cannot solve a problem using the troubleshooting tips in this section, you may need to call technical support. Have the following information available when you call:

- Monitor model number
- Monitor serial number
- Purchase date on invoice
- Conditions under which the problem occurred
- Error messages received
- Hardware configuration
- Name and version of the hardware and software you are using

Locating the serial number and product number

The serial number and product number are located on a label under the front bezel of the monitor head. You may need these numbers when contacting HP about the monitor.



4 Maintaining the monitor

Maintenance guidelines

To enhance the performance and extend the life of the monitor:

- Do not open the monitor cabinet or attempt to service this product yourself. Adjust only those controls that are covered in the operating instructions. If the monitor is not operating properly or has been dropped or damaged, contact an authorized HP dealer, reseller, or service provider.
- Use only a power source and connection appropriate for this monitor, as indicated on the label or back plate of the monitor.
- Be sure the total ampere rating of the products connected to the AC outlet does not exceed the current rating of the AC outlet, and the total ampere rating of the products connected to the cord does not exceed the rating of the cord. Look on the power label to determine the ampere rating (AMPS or A) for each device.
- Install the monitor near an outlet that you can easily reach. Disconnect the monitor by grasping the plug firmly and pulling it from the outlet. Never disconnect the monitor by pulling the cord.
- Turn the monitor off when it is not in use and use a screen saver program. Doing this can substantially increase the life expectancy of the monitor.



NOTE: A burned-in image on the monitor is not covered under the HP warranty.

- Never block the slots and openings of the cabinet or push objects into them. These openings provide ventilation.
- Do not drop the monitor or place it on an unstable surface.
- Do not allow anything to rest on the power cord. Do not walk on the cord.
- Keep the monitor in a well-ventilated area, away from excessive light, heat, or moisture.

Cleaning the monitor

1. Turn off the monitor and unplug the power cord from the AC outlet.
2. Dust the monitor by wiping the screen and the cabinet with a soft, clean antistatic cloth.
3. For more difficult cleaning situations, use a 50/50 mix of water and Isopropyl alcohol.



IMPORTANT: Do not use cleaners that contain any petroleum-based materials such as benzene, thinner, or any volatile substance to clean the monitor screen or cabinet. These chemicals may damage the monitor.

IMPORTANT: Spray the cleaner onto a cloth and use the damp cloth to gently wipe the screen surface. Never spray the cleaner directly on the screen surface. It may run behind the bezel and damage the electronics. The cloth should be moist, but not wet. Water dripping into the ventilation openings or other points of entry can cause damage to the monitor. Allow the monitor to air-dry before use.

Shipping the monitor

Keep the original packing box in a storage area. You may need it later if you ship the monitor or move.

A Technical specifications



NOTE: All specifications represent the typical specifications provided by HP's component manufacturers; actual performance may vary either higher or lower.

For the latest specifications or additional specifications on this product, go to <http://www.hp.com/go/quickspecs/> and search for your specific monitor model to find the model-specific QuickSpecs.

60.5 cm (23.8 in) model specifications

Table A-1 60.5 cm (23.8 in) model specifications

Specification	Measurement	
Display	60.5 cm wide screen	23.8 in wide screen
Type	IPS LCD	
Viewable image size	60.5 cm diagonal	23.8 in diagonal
Maximum weight (unpacked)	6.86 kg	15.13 lbs
Dimensions (including base)		
Height	49.44 cm	19.46 in
Depth	4.85 cm	1.91 in
Width	53.94 cm	21.24 in
Height adjustment range	15.0 cm	5.9 in
Tilt adjustment range	-5° to 20°	
Swivel adjustment range	30°	
Maximum graphic resolution	1920 × 1080	
Optimum graphic resolution	1920 × 1080	
Environmental requirements		
Operating temperature	5°C to 35°C	41°F to 95°F
Storage temperature	-20°C to 60°C	-4°F to 140°F
Storage humidity	5% to 95% (noncondensing)	
Operating humidity	20% to 80% (noncondensing)	
Altitude:		
Operating	0 m to 5,000 m	0 ft to 16,400 ft
Storage	0 m to 12,192 m	0 ft to 40,000 ft
Power source	100–240 VAC 50/60 Hz	
Measured power consumption		
Full power	175 W	

Table A-1 60.5 cm (23.8 in) model specifications (continued)

Specification	Measurement
Typical settings	70 W
Sleep	0.5 W
Off	0.5 W
USB Type-C power supply output	5 V DC, 5.0 A 9 V DC, 5.0 A 12 V DC, 5.0 A 15 V DC, 5.0 A 20 V DC, 5.0 A
Input terminal	One HDMI port, one DisplayPort connector, and one USB Type-C port

68.6 cm (27 in) model specifications

Table A-2 68.6 cm (27 in) model specifications

Specification	Measurement
Display	68.6 cm wide screen 27 in wide screen
Type	IPS LCD
Viewable image size	68.6 cm diagonal 27 in diagonal
Maximum weight (unpacked)	8.2 kg 18.08 lb
Dimensions (including base)	
Height	53.54 cm 21.08 in
Depth	4.85 cm 1.91 in
Width	61.36 cm 24.16 in
Height adjustment range	15.0 cm 5.9 in
Tilt adjustment range	-5° to 20°
Swivel adjustment range	30°
Maximum graphic resolution	2560 × 1440
Optimum graphic resolution	2560 × 1440
Environmental requirements	
Operating temperature	5°C to 35°C 41°F to 95°F
Storage temperature	-20°C to 60°C -4°F to 140°F
Storage humidity	5% to 95% (noncondensing)
Operating humidity	20% to 80% (noncondensing)
Altitude:	
Operating	0 m to 5,000 m 0 ft to 16,400 ft

Table A-2 68.6 cm (27 in) model specifications (continued)

Specification	Measurement
Storage	0 m to 12,192 m 0 ft to 40,000 ft
Power source	100–240 VAC 50/60 Hz
Measured power consumption	
Full power	175 W
Typical settings	80 W
Sleep	0.5 W
Off	0.5 W
USB Type-C power supply output	
	5 V DC, 5.0 A
	9 V DC, 5.0 A
	12 V DC, 5.0 A
	15 V DC, 5.0 A
	20 V DC, 5.0 A
Input terminal	One HDMI port, one DisplayPort connector, and one USB Type-C port

Preset display resolutions

The following display resolutions are the most commonly used modes and are set as factory defaults. The monitor automatically recognizes these preset modes, and they will appear properly sized and centered on the screen.

Table A-3 60.5 cm (23.8 in) preset display resolutions

Preset	Pixel format	Horz freq (kHz)	Vert freq (Hz)
(1)	640 × 480	31.469	59.940
(2)	720 × 400	31.469	70.087
(3)	800 × 600	37.879	60.317
(4)	1024 × 768	48.363	60.004
(5)	1280 × 720	45.000	60.000
(6)	1280 × 800	49.702	59.810
(7)	1280 × 1024	63.981	60.020
(8)	1440 × 900	55.935	59.887
(9)	1600 × 900	60.000	60.000
(10)	1680 × 1050	65.290	59.954
(11)	1920 × 1080	67.500	60.000

Table A-4 68.6 cm (27 in) preset display resolutions

Preset	Pixel format	Horz freq (kHz)	Vert freq (Hz)
(1)	640 × 480	31.469	59.940
(2)	720 × 400	31.469	70.087
(3)	800 × 600	37.879	60.317
(4)	1024 × 768	48.363	60.004
(5)	1280 × 720	45.000	60.000
(6)	1280 × 800	49.702	59.810
(7)	1280 × 1024	63.981	60.020
(8)	1440 × 900	55.935	59.887
(9)	1600 × 900	60.000	60.000
(10)	1680 × 1050	65.290	59.954
(11)	1920 × 1080	67.500	60.000
(12)	2560 × 1080	66.000	60.000
(13)	2560 × 1440	88.787	59.951

Table A-5 Preset timing resolutions

Preset	Timing name	Pixel format	Horz freq (kHz)	Vert freq (Hz)
(1)	480p	640 × 480	31.469	59.940
(2)	480p	720 × 480	31.469	59.940
(3)	720p60	1280 × 720	45.000	60.000
(4)	576p	720 × 576	31.250	50.000
(5)	720p50	1280 × 720	37.500	50.000
(6)	1080p60	1920 × 1080	67.500	60.000
(7)	1080p50	1920 × 1080	56.250	50.000

Entering user modes

Under the following conditions, the video controller signal may occasionally call for a mode that is not preset:

- You are not using a standard graphics adapter.
- You are not using a preset mode.

If this occurs, you may need to readjust the parameters of the monitor screen by using the on-screen display menu. You can make changes to any or all of these modes and save them in memory. The monitor automatically stores the new setting and then recognizes the new mode just as it does a preset mode. In addition to the factory preset modes, there are at least 10 user modes that you can enter and store.

Energy saver feature

The monitor supports a reduced power state. The reduced power state is initiated if the monitor detects the absence of either the horizontal sync signal or the vertical sync signal. Upon detecting the absence of these signals, the monitor screen is blank, the backlight is turned off, and the power light turns amber. When the monitor is in the reduced power state, the monitor uses < 0.5 W of power. There is a brief warm-up period before the monitor returns to its normal operating state.

See the computer manual for instructions on setting energy saver features (sometimes called power management features).



NOTE: The energy saver feature works only when the monitor is connected to a computer that has energy saver features.

B Accessibility

HP and accessibility

Because HP works to weave diversity, inclusion, and work/life into the fabric of the company, it is reflected in everything HP does. HP strives to create an inclusive environment focused on connecting people to the power of technology throughout the world.

Finding the technology tools you need

Technology can unleash your human potential. Assistive technology removes barriers and helps you create independence at home, at work, and in the community. Assistive technology helps increase, maintain, and improve the functional capabilities of electronic and information technology. For more information, see [Finding the best assistive technology on page 37](#).

The HP commitment

HP is committed to providing products and services that are accessible for people with disabilities. This commitment supports the company's diversity objectives and helps ensure that the benefits of technology are available to all.

The HP accessibility goal is to design, produce, and market products and services that can be effectively used by everyone, including people with disabilities, either on a stand-alone basis or with appropriate assistive devices.

To achieve that goal, this Accessibility Policy establishes seven key objectives to guide HP actions. All HP managers and employees are expected to support these objectives and their implementation in accordance with their roles and responsibilities:

- Raise the level of awareness of accessibility issues within HP, and provide employees with the training they need to design, produce, market, and deliver accessible products and services.
- Develop accessibility guidelines for products and services, and hold product development groups accountable for implementing these guidelines where competitively, technically, and economically feasible.
- Involve people with disabilities in the development of accessibility guidelines and in the design and testing of products and services.
- Document accessibility features, and make information about HP products and services publicly available in an accessible form.
- Establish relationships with leading assistive technology and solution providers.
- Support internal and external research and development that improves assistive technology relevant to HP products and services.
- Support and contribute to industry standards and guidelines for accessibility.

International Association of Accessibility Professionals (IAAP)

IAAP is a not-for-profit association focused on advancing the accessibility profession through networking, education, and certification. The objective is to help accessibility professionals develop and advance their careers and to better enable organizations to integrate accessibility into their products and infrastructure.

As a founding member, HP joined to participate with other organizations to advance the field of accessibility. This commitment supports HP's accessibility goal of designing, producing, and marketing products and services that people with disabilities can effectively use.

IAAP will make the profession strong by globally connecting individuals, students, and organizations to learn from one another. If you are interested in learning more, go to <http://www.accessibilityassociation.org> to join the online community, sign up for newsletters, and learn about membership options.

Finding the best assistive technology

Everyone, including people with disabilities or age-related limitations, should be able to communicate, express themselves, and connect with the world using technology. HP is committed to increasing accessibility awareness within HP and with our customers and partners. Whether it's large fonts that are easy on the eyes, voice recognition that lets you give your hands a rest, or any other assistive technology to help with your specific situation—a variety of assistive technologies make HP products easier to use. How do you choose?

Assessing your needs

Technology can unleash your potential. Assistive technology removes barriers and helps you create independence at home, at work, and in the community. Assistive technology (AT) helps increase, maintain, and improve the functional capabilities of electronic and information technology.

You can choose from many AT products. Your AT assessment should allow you to evaluate several products, answer your questions, and facilitate your selection of the best solution for your situation. You will find that professionals qualified to do AT assessments come from many fields, including those licensed or certified in physical therapy, occupational therapy, speech/language pathology, and other areas of expertise. Others, while not certified or licensed, can also provide evaluation information. You will want to ask about the individual's experience, expertise, and fees to determine if they are appropriate for your needs.

Accessibility for HP products

The following links provide information about accessibility features and assistive technology, if applicable, included in various HP products. These resources will help you select the specific assistive technology features and product(s) most appropriate for your situation.

- [HP Elite x3—Accessibility Options \(Windows 10 Mobile\)](#)
- [HP PCs—Windows 7 Accessibility Options](#)
- [HP PCs—Windows 8 Accessibility Options](#)
- [HP PC's—Windows 10 Accessibility Options](#)
- [HP Slate 7 Tablets—Enabling Accessibility Features on Your HP Tablet \(Android 4.1/Jelly Bean\)](#)
- [HP SlateBook PCs—Enabling Accessibility Features \(Android 4.3, 4.2/Jelly Bean\)](#)
- [HP Chromebook PCs—Enabling Accessibility Features on Your HP Chromebook or Chromebox \(Chrome OS\)](#)
- [HP Shopping—peripherals for HP products](#)

If you need additional support with the accessibility features on your HP product, see [Contacting support on page 40](#).

Additional links to external partners and suppliers that may provide additional assistance:

- [Microsoft Accessibility information \(Windows 7, Windows 8, Windows 10, Microsoft Office\)](#)
- [Google Products accessibility information \(Android, Chrome, Google Apps\)](#)

- [Assistive Technologies sorted by impairment type](#)
- [Assistive Technologies sorted by product type](#)
- [Assistive Technology vendors with product descriptions](#)
- [Assistive Technology Industry Association \(ATIA\)](#)

Standards and legislation

Standards

Section 508 of the Federal Acquisition Regulation (FAR) standards was created by the US Access Board to address access to information and communication technology (ICT) for people with physical, sensory, or cognitive disabilities. The standards contain technical criteria specific to various types of technologies, as well as performance-based requirements which focus on functional capabilities of covered products. Specific criteria cover software applications and operating systems, web-based information and applications, computers, telecommunications products, video and multimedia, and self-contained closed products.

Mandate 376 – EN 301 549

The EN 301 549 standard was created by the European Union within Mandate 376 as the basis for an online toolkit for public procurement of ICT products. The standard specifies the functional accessibility requirements applicable to ICT products and services, together with a description of the test procedures and evaluation methodology for each accessibility requirement.

Web Content Accessibility Guidelines (WCAG)

Web Content Accessibility Guidelines (WCAG) from the W3C's Web Accessibility Initiative (WAI) helps web designers and developers create sites that better meet the needs of people with disabilities or age-related limitations. WCAG advances accessibility across the full range of web content (text, images, audio, and video) and web applications. WCAG can be precisely tested, is easy to understand and use, and allows web developers flexibility for innovation. WCAG 2.0 has also been approved as [ISO/IEC 40500:2012](#).

WCAG specifically addresses barriers to accessing the web experienced by people with visual, auditory, physical, cognitive, and neurological disabilities, and by older web users with accessibility needs. WCAG 2.0 provides characteristics of accessible content:

- **Perceivable** (for instance, by addressing text alternatives for images, captions for audio, adaptability of presentation, and color contrast)
- **Operable** (by addressing keyboard access, color contrast, timing of input, seizure avoidance, and navigability)
- **Understandable** (by addressing readability, predictability, and input assistance)
- **Robust** (for instance, by addressing compatibility with assistive technologies)

Legislation and regulations

Accessibility of IT and information has become an area of increasing legislative importance. The links listed below provide information about key legislation, regulations, and standards.

- [United States](#)
- [Canada](#)
- [Europe](#)

- [United Kingdom](#)
- [Australia](#)
- [Worldwide](#)

Useful accessibility resources and links

The following organizations might be good resources for information about disabilities and age-related limitations.



NOTE: This is not an exhaustive list. These organizations are provided for informational purposes only. HP assumes no responsibility for information or contacts you encounter on the Internet. Listing on this page does not imply endorsement by HP.

Organizations

- American Association of People with Disabilities (AAPD)
- The Association of Assistive Technology Act Programs (ATAP)
- Hearing Loss Association of America (HLAA)
- Information Technology Technical Assistance and Training Center (ITTATC)
- Lighthouse International
- National Association of the Deaf
- National Federation of the Blind
- Rehabilitation Engineering & Assistive Technology Society of North America (RESNA)
- Telecommunications for the Deaf and Hard of Hearing, Inc. (TDI)
- W3C Web Accessibility Initiative (WAI)

Educational institutions

- California State University, Northridge, Center on Disabilities (CSUN)
- University of Wisconsin - Madison, Trace Center
- University of Minnesota computer accommodations program

Other disability resources

- ADA (Americans with Disabilities Act) Technical Assistance Program
- ILO Global Business and Disability network
- EnableMart
- European Disability Forum
- Job Accommodation Network
- Microsoft Enable

HP links

[Our contact webform](#)

[HP comfort and safety guide](#)

[HP public sector sales](#)

Contacting support



NOTE: Support is in English only.

- Customers who are deaf or hard of hearing who have questions about technical support or accessibility of HP products:
 - Use TRS/VRS/WebCapTel to call (877) 656-7058 Monday through Friday, 6 a.m. to 9 p.m. Mountain Time.
- Customers with other disabilities or age-related limitations who have questions about technical support or accessibility of HP products, choose one of the following options:
 - Call (888) 259-5707 Monday through Friday, 6 a.m. to 9 p.m. Mountain Time.
 - Complete the [Contact form for people with disabilities or age-related limitations](#).